

*The Fusion Energy Program: The Role of  
TPX and Alternate Concepts*

February 1995

OTA-BP-ETI-141

GPO stock #052-003-01403-3

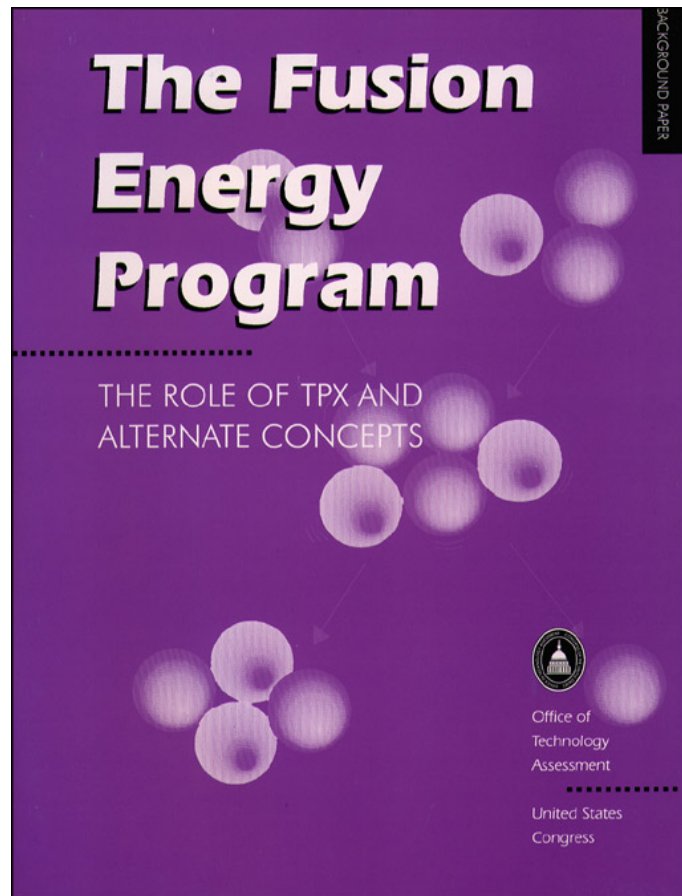

**Recommended Citation:** U.S. Congress, Office of Technology Assessment, *The Fusion Energy Program: The Role of TPX and Alternate Concepts*, OTA-BP-ETI-141 (Washington, DC: U.S. Government Printing Office, February 1995).

# Foreword

**F**or over four decades the federal government has supported research to develop reactors that harness fusion energy for commercial electric power production. However, even the most optimistic proponents of the U.S. Department of Energy's fusion energy program note that many scientific, engineering, and economic challenges remain. Meeting these challenges sufficiently to construct a prototype commercial fusion powerplant is expected to require tens of billions of dollars in experimental facilities and research over the next several decades.

This background paper, responding to a request by the House Committee on Science, focuses on the following two questions for the U.S. fusion energy program. First, what is the role of the Tokamak Physics Experiment (TPX), an approximately \$700 million fusion reactor currently awaiting a congressional decision to begin construction? This paper examines the history of TPX planning; the anticipated scientific, engineering, and institutional contributions; and the relationship between the TPX and the next major planned tokamak facilities, the International Thermonuclear Experimental Reactor (ITER), currently in the design stage, and the DEMO facility planned for operation in about three decades, which would be the first fusion device to demonstrate production of electricity.

Second, what is the role of alternatives to the tokamak concept in a broad-based fusion energy program? Over the past several years the program has been narrowed substantially to concentrate on the single most successful and furthest developed fusion energy concept, the tokamak. This narrowing, driven heavily by budgetary reasons, has been decried by many fusion researchers as premature given the current elementary state of fusion knowledge. This study examines the motives for pursuing alternate concepts, the steps involved and costs of alternate concept research, and the current status of alternate concept research as conducted in the U.S. fusion energy program.

While the focus of the study is on the TPX and alternate concepts, it also provides a history of the overall fusion energy program. With this context, the study identifies (but does not answer) some underlying questions that must be addressed. The most pressing of these are: what is the potential role of the fusion energy program in meeting long-term energy needs? what level of research funding is justified by that role? and what are the most reasonable goals and directions for the program under scenarios of flat or declining budgets?

OTA received generous assistance from workshop participants, reviewers, and others who offered valuable information and comments in the course of this study. To all of them goes the gratitude of OTA and the personal thanks of the project staff.



**ROGER C. HERDMAN**  
Director

# Workshop

**Alan Crane, *Chairman***

Senior Associate  
Energy, Transportation, and  
Infrastructure Program  
Office of Technology Assessment

**Donald Correll**

Deputy Program Leader for  
Inertial Confinement Fusion  
Lawrence Livermore National  
Laboratory

**David H. Crandall**

Director, Applied Plasma Physics  
Division  
Office of Energy Research  
U.S. Department of Energy

**N. Anne Davies**

Associate Director for Fusion  
Energy  
Office of Energy Research  
U.S. Department of Energy

**Stephen O. Dean**

President  
Fusion Power Associates

**Robert Hirsch**

Consultant

**Alan Hoffman**

Aerospace and Energetics  
Research Building  
University of Washington, Seattle

**Jack Kaslow**

Executive Director, Northeast  
Region  
Electric Power Research Institute

**William D. Kay**

Department of Political Sciences  
Northeastern University

**Dale M. Meade**

Deputy Director  
Princeton University  
Plasma Physics Laboratory

**David O. Overskei**

Senior Vice President  
General Atomics

**John Perkins**

Physicist and Group Leader  
Lawrence Livermore National  
Laboratory

**Stewart C. Prager**

President, University Fusion  
Association and Professor  
Department of Physics  
University of Wisconsin-Madison

**Paul-Henri Rebut**

International Thermonuclear  
Experimental Reactor  
Engineering Design Activities

**John Sheffield**

Fusion Energy Division  
Oak Ridge National Laboratory

**John W. Willis**

Director, Confinement Systems  
Division  
Office of Energy Research  
U.S. Department of Energy

**Note:** OTA appreciates and is grateful for the valuable assistance and thoughtful critiques provided by the workshop participants. The participants do not, however, necessarily approve, disapprove, or endorse this report. OTA assumes full responsibility for the report and the accuracy of its contents.

# Project Staff

**Peter D. Blair**

Assistant Director  
Industry, Commerce, and  
International Security Division

**Emilia L. Govan**

Program Director  
Energy, Transportation, and  
Infrastructure Program

**ADMINISTRATIVE STAFF****Marsha Fenn**

Office Administrator

**Tina Aikens**

Administrative Secretary

**Gay Jackson**

PC Specialist

**Lillian Chapman**

Division Administrator

**PRINCIPAL STAFF****Robin Roy**

Project Director

**Karen Larsen**

Senior Analyst

**Richard Rowberg**

Senior Specialist  
Congressional Research Service

**PUBLISHING STAFF****Mary Lou Higgs**

Manager

**Dorinda Edmondson**

Typographer

**Susan Hoffmeyer**

Graphic Designer

**Chip Moore**

Production Editor

**Chris Onrubia**

Senior Graphic Designer

# Reviewers and Contributors

**Anna Aurilio**

U.S. Public Interest Research  
Group

**Charles Baker**

University of California,  
San Diego

**David E. Baldwin**

Lawrence Livermore National  
Laboratory

**Roger Bangerter**

University of California, Berkeley

**Richard Brody**

Office of Technology Assessment

**Mark Brown**

Office of Technology Assessment

**E. Michael Campbell**

Lawrence Livermore National  
Laboratory

**Valeriy Chuyanov**

International Thermonuclear  
Experimental Reactor  
Engineering Design Activities

**Thomas Cochran**

Natural Resources Defense  
Council

**Tony Colleraine**

General Atomics

**Donald Correll**

Lawrence Livermore National  
Laboratory

**David H. Crandall**

U.S. Department of Energy

**N. Anne Davies**

U.S. Department of Energy

**Stephen O. Dean**

Fusion Power Associates

**James F. Decker**

U.S. Department of Energy

**Gerald Epstein**

Office of Technology Assessment

**Julie Van Fleet**

International Thermonuclear  
Experimental Reactor  
Engineering Design Activities

**Robert Goldston**

Princeton Plasma Physics  
Laboratory

**Robert Hirsch**

Consultant

**Alan Hoffman**

Oak Ridge National Laboratory

**Rush D. Holt**

Princeton Plasma Physics  
Laboratory

**Paul Komor**

Office of Technology Assessment

**Grant Logan**

Lawrence Livermore National  
Laboratory

**Bogdan C. Maglich**

Advanced Physics Corp.

**Dale M. Meade**

Princeton Plasma Physics  
Laboratory

**David O. Overskei**

General Atomics

**John Perkins**

Lawrence Livermore National  
Laboratory

**Stewart Prager**

University Fusion Association  
University of Wisconsin, Madison

**Paul-Henri Rebut**

International Thermonuclear  
Experimental Reactor  
Engineering Design Activities

**Michael Roberts**

U.S. Department of Energy

**Marshall N. Rosenbluth**  
International Thermonuclear  
Experimental Reactor  
Engineering Design Activities

**Norman Rostoker**  
Department of Physics  
University of California, Irvine

**Joanne Sedor**  
Office of Technology Assessment

**John Sheffield**  
Oak Ridge National Laboratory

**Yasuo Shimomura**  
International Thermonuclear  
Experimental Reactor  
Engineering Design Activities

**Loren Steinhaur**  
Redmond Plasma Physics  
Laboratories  
University of Washington

**Ravi Sudan**  
Laboratory of Plasma Studies  
Cornell University

**Matthew Weinberg**  
Office of Technology Assessment

**John W. Willis**  
U.S. Department of Energy

**Note:** OTA appreciates and is grateful for the valuable assistance and thoughtful critiques provided by the reviewers. The reviewers do not, however, necessarily approve, disapprove, or endorse this report. OTA assumes full responsibility for the report and the accuracy of its contents.

# Contents

<b>1</b>	<b>Overview and Findings</b>	<b>1</b>
	Achievements and Challenges of the U.S. Fusion Energy Program	6
	Findings on TPX	9
	Findings on Alternate Concepts for Fusion Energy	12
<b>2</b>	<b>The Federal Fusion Energy Research Program</b>	<b>17</b>
	History of U.S. Fusion Energy Research	18
	The Fusion Program Goals in Law and Policy	32
	Legislative Directives	36
	Federal Fusion Energy Research Programs	36
	Future Budget Choices	46
<b>3</b>	<b>The Tokamak Physics Experiment</b>	<b>49</b>
	History of the TPX Decision	50
	Description of TPX	53
	Issues	57
<b>4</b>	<b>Alternate Concepts for Fusion Energy</b>	<b>65</b>
	Reasons to Pursue Alternate Fusion Concepts	65
	Status and Prospects of Alternate Concepts	68
	Steps in Examining Alternate Concepts	76
	DOE's Program for Alternate Concepts	78
	Conclusion	80
<b>APPENDIX</b>		
<b>A</b>	<b>Acronyms and Glossary of Terms</b>	<b>81</b>

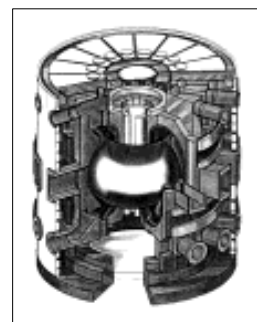
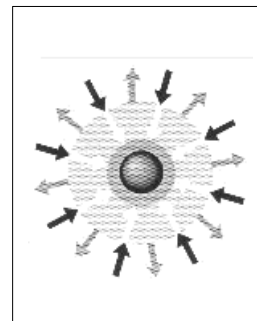



# Overview and Findings | 1

**F**or over four decades the federal government has supported research to develop the power of fusion energy for commercial electric power production. Fusion proponents note that the supply of fusion fuels is virtually inexhaustible, and that environmental impacts may be far less extensive than those of energy supplies currently in widespread use. Widely heralded experiments performed in 1993 and 1994 at the Princeton Plasma Physics Laboratory's Tokamak Fusion Test Reactor (TFTR) produced unprecedented levels of fusion reactions and continued a trend of progress in fusion research.

However, even the most optimistic proponents of fusion energy note that many scientific, engineering, and economic challenges remain to be met. Meeting these challenges sufficiently to construct a prototype commercial fusion powerplant may require several tens of billions of dollars in experimental facilities and research over the next several decades. This would require a considerable increase from the U.S. Department of Energy's (DOE's) current fusion energy program budget of \$373 million, and a greater level of cost-sharing through international collaboration in fusion research and development.<sup>1</sup>

In 1987, the Office of Technology Assessment (OTA) concluded a major assessment of the fusion energy program and published the report *Starpower: The U.S. and the International Quest*



<sup>1</sup> An additional \$176 million is spent on inertial confinement fusion research as part of DOE's defense programs, much of which is relevant to fusion energy prospects.

## 2 The Fusion Energy Program: The Role of TPX and Alternate Concepts

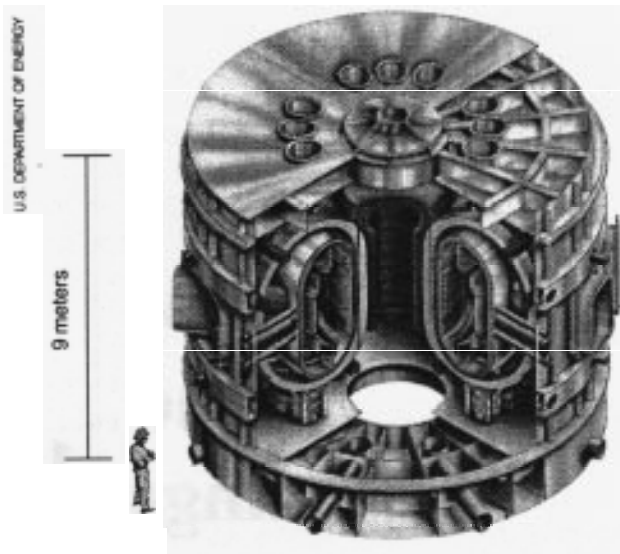

The proposed Tokamak Physics Experiment (TPX).

for Fusion Energy.<sup>2</sup> Since then, the U.S. fusion energy program has undergone a pronounced change as it has grappled with uncertain budgets that have grown less quickly than the need for larger, more capable, and more expensive machines. One result has been a substantial narrowing of efforts to concentrate on the single most successful and furthest developed fusion concept, the tokamak. This narrowing, driven heavily by budgetary reasons, has been decried by many fusion researchers as premature given the current state of fusion knowledge.

This background paper, requested by the House Committee on Science, Space, and Technology,<sup>3</sup> focuses on two issues in the recent and continuing evolution of the U.S. fusion energy research and development (R&D) program:

- **What is the role of the proposed Tokamak Physics Experiment (TPX)?** TPX is an approximately \$700-million fusion reactor currently in an advanced stage of engineering design and awaits a congressional decision to begin construction at the Princeton Plasma

Physics Laboratory. This paper examines the history of TPX planning and the anticipated scientific, engineering, and institutional contributions of the TPX. It explores the relationship between the TPX and the next major planned tokamak facilities, the International Thermonuclear Experimental Reactor (ITER), currently in the design stage, and the Demonstration Fusion Powerplant (DEMO) facility, planned for operation in about three decades, which would be the first fusion device to demonstrate production of electricity.

- **What is the role of alternatives to the tokamak concept in a broad-based fusion energy program?** This paper examines the motives for pursuing alternate concepts, the steps involved and costs of alternate concept research, and the current status and process of alternate concept research as conducted in the U.S. fusion energy program. Note that this paper does not assess the likely attractiveness of any alternate fusion concept, nor does it suggest the appropriate level of effort to be devoted to it. Rather, the paper reviews the level of development, which may not be closely related to the long-term potential of a concept.

There are critical issues for the U.S. fusion energy program that are beyond the scope of this background paper. Three of the most important are noted here. First, **this paper does not examine the rationale for the overall fusion energy program. In particular, the role of the fusion energy program in meeting long-term energy needs and the level of research effort justified by that potential role are critical issues for the program.** Whether or when fusion will meet the goal of becoming an economically and environmentally attractive energy option will depend on more than just success in a continuing multi-decade R&D program. It will also depend on the pace of progress in the other energy technologies

<sup>2</sup>U.S. Congress, Office of Technology Assessment, *Starpower: The U.S. and the International Quest for Fusion Energy*, OTA-E-338 (Washington, DC: U.S. Government Printing Office, October 1987).

<sup>3</sup>Renamed the House Committee on Science.

with which fusion must eventually compete. These energy technologies span a broad array, from advanced nuclear fission reactors to renewables such as biomass, wind, and photovoltaics to improved methods for finding, extracting, and burning fossil fuels including coal, natural gas, and oil. Substantial improvements in energy efficiency technologies continue as well.<sup>4</sup> To the extent that these energy technologies continue to improve, they present an increasingly challenging market environment for future fusion powerplants. While progress in fusion is continuing, other energy technologies are improving as well, often with some federal support. The tradeoffs in timing and choice of R&D efforts in competing energy technologies including fusion are critical issues for fusion research policy beyond the scope of this paper.<sup>5</sup>

A second and related critical issue for the fusion energy program not addressed in this paper has to do with the possibility of declining budgets. **Proposals to greatly reduce fusion energy research spending heighten the importance of identifying possible new roles, directions, and goals for the program under scenarios of flat or declining budgets.** This paper discusses the likely cost involved in continuing along the current path of fusion research, and it is substantial. As noted below, the current fusion energy program goals and directions, including construction and operation of large new tokamaks, are inconsistent even with flat budgets; the possibility of declining budgets sharpens the issue. Certainly, potentially valuable work can be performed under a wide range of research budgets. However, this would

call for revised goals and directions. For example, even under substantial cuts, some see the possibility of sustaining progress by focusing on physics issues using existing machines, increasing international collaboration, supporting a modest but expanded effort to investigate alternate concepts, and concentrating on materials and technology advances that would be necessary for fusion powerplants.

An effort to identify the most productive uses of fusion energy funds under a variety of scenarios could provide information critical in making budget decisions. Eventually, however, absent novel, unexpected science developments, progress toward development of a fusion powerplant would require a commitment to construction of expensive new facilities. Finally, under any budget scenario, consideration must be given to existing commitments such as decommissioning TFTR and the international agreement to complete the engineering design of ITER. These two commitments alone total a few hundred million dollars over the next several years.

**A third critical issue for the U.S. fusion energy program that is beyond the scope of this background paper has to do with the increasing internationalization of research.**<sup>6</sup> Due to the very high estimated cost of some fusion facilities, the domestic fusion energy program is pursuing cost-sharing collaborative efforts with several countries. ITER, with a roughly estimated design and construction cost on the order of \$10 billion, is the leading example (see box 1-1). The institutional structure for this type of international col-

<sup>4</sup> See, e.g., the following reports by U.S. Congress, Office of Technology Assessment: *Energy Efficiency: Challenges and Opportunities for Electric Utilities*, OTA-E-561 (Washington, DC: U.S. Government Printing Office, September 1993); *Industrial Energy Efficiency*, OTA-E-560 (August 1993); *Building Energy Efficiency*, OTA-E-518 (May 1992); *Energy Efficiency in Federal Facilities: Government by Good Example?* OTA-E-492 (May 1991).

<sup>5</sup> See U.S. Congress, Office of Technology Assessment, *Energy Technology Choices*, OTA-E-493 (Washington, DC: U.S. Government Printing Office, July 1991). The Secretary of Energy recently commissioned a review of DOE civilian energy R&D programs that will address this issue at some level. See The Honorable Hazel R. O'Leary, Secretary of Energy, letter to George M. Scalise, Sept. 8, 1994. Also, the President's Council of Advisors on Science and Technology will report on the fusion energy program in Summer 1995.

<sup>6</sup> OTA is currently examining the role of international collaboration in large science projects. That effort, due for completion in summer 1995, will examine the increasingly international character of several scientific fields, including that of fusion energy research.

## 4 The Fusion Energy Program: The Role of TPX and Alternate Concepts

### BOX 1-1: The International Thermonuclear Experimental Reactor

The United States, the European Union, Japan, and the Russian Federation are engaged in an unprecedented collaboration on the engineering design of the proposed International Thermonuclear Experimental Reactor (ITER). This collaboration has its roots in discussions among the leaders of the European Community, Japan, the Soviet Union, and the United States in the mid-1980s. ITER's purpose is to establish the scientific and technological feasibility of magnetic fusion energy as a source of electric power by demonstrating controlled ignition and extended burn of deuterium-tritium plasmas and to demonstrate and test technologies, materials, and nuclear components essential to development of fusion energy for practical purposes. It would not be capable, however, of actually generating electricity. Demonstrating the production of electricity in a magnetic fusion energy powerplant would be left to the DEMO reactor, a device anticipated for construction no sooner than 2025.

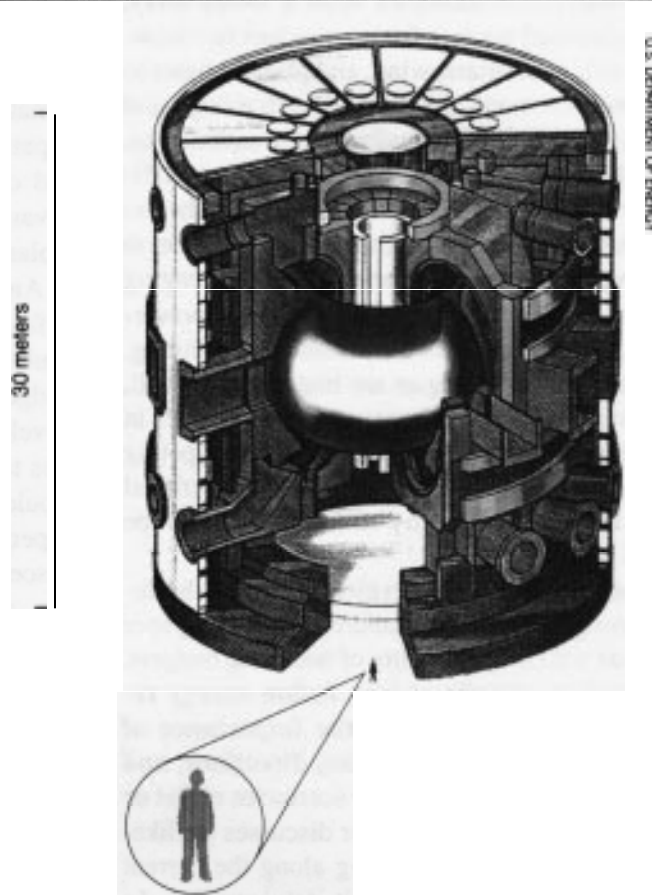

*The proposed International Thermonuclear Experimental Reactor.*

If built, ITER would be by far the largest, most capable, and costliest fusion experiment in the world. ITER uses a tokamak design, and would stand over eight stories tall and 30 meters in diameter. The device is intended to sustain controlled fusion reactions in a pulsed mode for periods of up to 15 minutes. ITER is expected to be capable of producing over 1,000 megawatts of thermal fusion power. Temperatures inside the confinement chamber would be up to 1,000 degrees centigrade, and maintenance and monitoring of the radioactive containment will have to be carried out by remote methods. The impressive scale of ITER is dictated by the physical requirements of heating and containing a plasma to fusion conditions on a steady state basis using available technology and materials. ITER offers not only great scientific challenges, but practical technological challenges as well. For example, ITER's superconducting magnetic coils will be the largest ever manufactured. Each coil will weigh over 400 tons. The amount of superconducting materials required to make them exceeds the available manufacturing capabilities of any one party, therefore a cooperative effort is underway to coordinate the materials manufacture, fabrication, and assembly.

ITER is being conducted in four phases under formal intergovernmental agreements among the parties. These are: 1) the now-completed conceptual design activities (CDA); 2) the engineering design activities (EDA); 3) the construction phase; and 4) the operations phase. Each phase is to be governed

## BOX 1-1 (cont'd.): The International Thermonuclear Experimental Reactor

by a separate agreement among the parties and costs are shared equally. The first phase of the ITER project, CDA, was carried out from January 1988 to December 1990. All four parties contributed personnel and support to the ITER team for development of a conceptual design, scope, and mission for the project.

Currently, ITER is in the EDA phase, which is scheduled to continue until July 1998. Under the ITER Agreements, each of the parties has committed the equivalent of \$300 million (1993 dollars) worth of personnel and equipment to the design effort. The purpose of the ITER EDA phase is to produce a "detailed, complete, and fully integrated engineering design of ITER and all technical data necessary for future decisions on the construction of ITER." On completion, the design and technical data will be available for each of the parties to use either as part of an international collaborative program or in its own domestic program. Other objectives of the EDA phase are to conduct validating R&D supporting the engineering design of ITER, to establish siting requirements, to perform environmental and safety analyses related to the site, and to establish a program for ITER operation and decommissioning.

EDA activities are overseen by an ITER Council composed of two representatives of each party. Decisions by the Council are based on consensus. Under the Council, the ITER Director is responsible for coordinating the activities of the Joint Central Team—an international design team composed of scientists, engineers, and other professionals assigned to the ITER project by the parties. The Joint Central Team activities are carried out at three Joint Work Sites—Garching, Germany; Naka, Japan; and San Diego, California. Each work site team is responsible for a different aspect of ITER design. The work of the Joint Central Team is supported by R&D activities by the "home country" fusion programs. Tasks are assigned and coordinated by the ITER Director in consultation with the ITER Council, the Joint Central Team, and each party's designated "Home Team" Leader.

The next major step in the ITER process will be the negotiation of a process for deciding on a host site for ITER. Exploratory discussions on a site selection process are currently underway. Site selection will have to be accomplished so that the EDA team can complete specific site-related safety, environmental and economic analyses, and design work for the ITER facility. Following site selection, a decision on whether to proceed to ITER construction and operations phases is scheduled to be made before 1998 and would require a new international agreement.

The ITER construction phase is tentatively planned to start in 1998 and to be completed by 2005. Initial estimates of ITER construction cost had been \$6.9 billion in July 1993 dollars; some analysts have projected ITER costs of between \$8 billion to \$10 billion. Detailed cost estimates for this one-of-a kind research facility await completion of ITER engineering design work. Interim design and cost analyses are expected in mid-1995. Final design and cost estimates are due in January 1998, assuming site selection has been completed.

The fourth or operating phase of ITER is proposed to begin in 2005 and run through approximately 2025. The early phases of ITER operation would be dominated by a focus on the physics issues relating to achieving and sustaining an ignited plasma. A more intense engineering phase will follow. As an engineering test facility, researchers would be able to install, test, and remove numerous ITER components, experimental packages, and test modules to test materials properties, component characteristics, performance, and lifetimes in an environment approximating the conditions of an operating fusion powerplant. This experience would aid efforts at design and development of a demonstration fusion powerplant.

## 6 | The Fusion Energy Program: The Role of TPX and Alternate Concepts

laboration in the construction and operation of large facilities remains to be developed, and its ultimate success will require dedication, flexibility, and innovation. This paper does examine one current case in the coordination of the domestic fusion energy program in the increasingly international fusion arena—the methods by which TPX is coordinated with ITER, and the potential contribution of TPX to that much more ambitious facility. It does not, however, examine the methods by which ITER can be successfully developed, nor does it evaluate key issues in the ITER program as it relates to the broader fusion energy development effort, such as project scope and timing. Further, it does not examine how the overall U.S. fusion energy program, including alternate concepts research, could be more fully integrated into the world effort.

### ACHIEVEMENTS AND CHALLENGES OF THE U.S. FUSION ENERGY PROGRAM

Fusion reactions, which power our sun and the stars, occur when the nuclei of two lightweight atoms (e.g., isotopes of hydrogen such as deuterium and tritium) combine together, or fuse, releasing energy (see figure 1-1). Understanding and controlling the conditions that allow practical fusion to occur on earth, such as temperatures of about 100 million degrees Celsius, present great scientific and technical challenges. At such high temperatures, matter exists as plasma (a state in which atoms are broken down into electrons and nuclei) that cannot be contained by any solid container.

Primary responsibility for fusion energy development rests with DOE and its Office of Energy Research. Most effort in fusion energy research has been devoted to the magnetic confinement approach, which uses magnetic fields to control the range of motion of the plasma. Several different magnetic fusion energy (MFE) confinement con-

cepts have been investigated, the most advanced of which is the tokamak reactor. Considerable effort has also been devoted to inertial confinement, in which a pellet of fusion fuel would be heated and compressed by intense lasers or ion drivers to such high densities that the fuel's own inertia is sufficient to contain it for the very short time needed for fusion to occur. Inertial confinement fusion research mimics, on a very much smaller scale, processes in the hydrogen bomb, and to date, much of the research relevant to inertial fusion energy (IFE) has been performed by DOE's Office of Defense Programs for its applications to nuclear weapons physics and stockpile stewardship responsibilities.

The ultimate goal of DOE's fusion energy program is "to demonstrate that fusion energy is a technically and economically viable energy source." DOE's primary emphasis in fusion energy is on developing the tokamak, and devotes by far the largest share of the current fusion energy budget to support design of two planned tokamak reactors. Of the \$373 million requested budget for fiscal year 1995, 41 percent was for direct and indirect design and support of ITER, and 33 percent was intended for design, construction, and support of TPX.<sup>7</sup> Another 14 percent was to support operations of the largest operating U.S. tokamak, TFTR. The remainder of the fusion energy budget is devoted to such diverse activities as advanced materials development, fusion technology development, and study of alternate concepts including IFE. In addition, in fiscal year 1995 the Office of Defense Programs devoted \$176 million to inertial confinement fusion research, much of which is relevant to IFE.

**Much progress has been made in fusion energy research over the past few years, but far more remains to be done.** Most notably, recent experiments at TFTR attained a record in fusion energy production of 10.7 megawatts (MW),

---

<sup>7</sup> U.S. Department of Energy, "Fusion Energy Program," briefing package presented by N. Anne Davies to Office of Technology Assessment staff, Apr. 28, 1994. Note that of the \$152 million related to ITER, \$81 million was for a diverse array of "support" activities rather than direct ITER design and R&D work. Similarly, of the \$118 million related to TPX, \$56 million was for support.

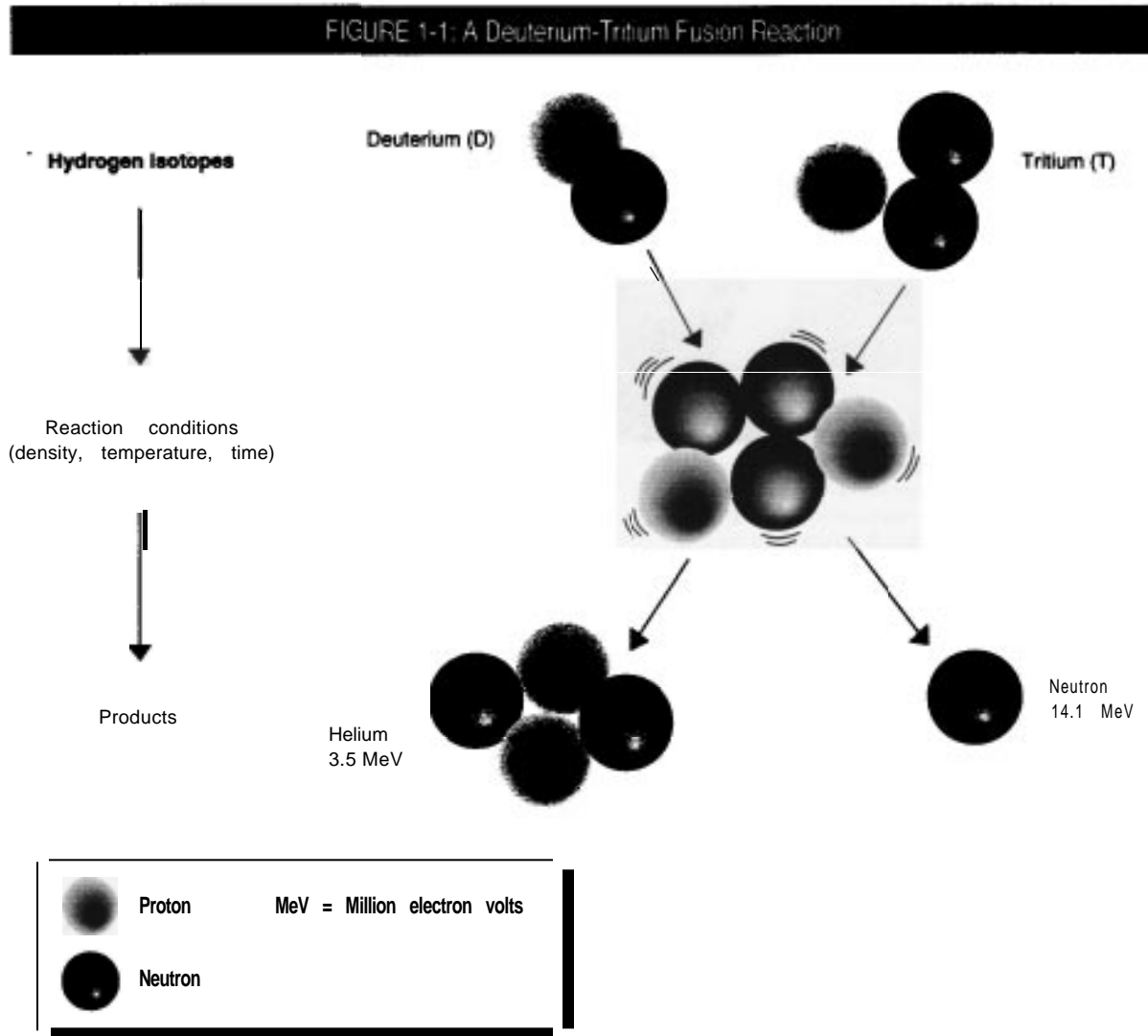

SOURCE: Office of Technology Assessment 1995, based on figure from U.S. Department of Energy, Office of Fusion Energy.

amounting to a factor of about 100 million increase in fusion power production over 20 years of research. However, even the tokamak, the most advanced fusion energy concept, faces scientific and engineering challenges. Scientific challenges remaining to be met for MFE include achieving *high energy gain* (energy output that is many

times higher than energy input to create the reactions) and *ignition* (the point at which a reaction is self-sustaining even when external heating is turned off) in a *steady state* (continuous, rather than intermittent, operation).<sup>8</sup> However, even *breakeven* (the Point at which the energy produced

<sup>8</sup>Fusion scientists typically have defined scientific feasibility as attainment of high energy gainer ignition. Steady state operation is generally not included in definitions of scientific feasibility, although it presents an important scientific challenge that must be met by any MFE power-plant.

## 8 The Fusion Energy Program: The Role of TPX and Alternate Concepts

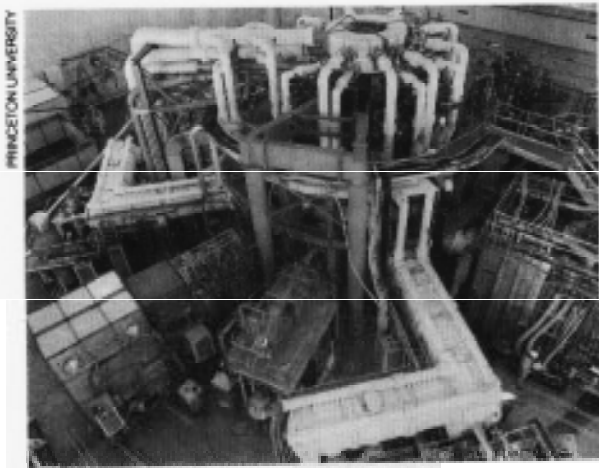

The Tokamak Fusion Test Reactor (TFTR) at the Princeton Plasma Physics Laboratory set world records for fusion reactions using deuterium-tritium fuel in 1993 and 1994. TFTR, the largest U.S. tokamak, is scheduled to be shut down in 1995.

by fusion reactions equals the energy input to heat the plasma<sup>9</sup>) has remained beyond the reach of current facilities.<sup>10</sup> The highly successful TFTR experiments of the past year, for example, reached just over one-quarter of breakeven--about 40 MW of external power were introduced to the plasma to create about 10.7 MW in fusion reactions. This fusion energy production lasted for only a few moments. If constructed, ITER would be the first MFE device expected to achieve ignition, and to operate for long pulses of several hundred to over one thousand seconds.

Developing a commercial prototype fusion powerplant requires more than merely meeting scientific challenges. It further requires meeting a series of engineering challenges, including development of materials, components, and systems for operating fusion reactors. According to DOE, the

main scientific and technological issues for the MFE effort are the following:

1. ignition physics (e.g., understanding the properties of a self-sustaining fusion reaction);
2. magnetic confinement configuration optimization (i.e., determining how best to shape the magnetic fields confining the plasma);
3. fusion nuclear technology (engineering systems to fuel, maintain, and recover energy from a fusion reactor); and
4. low activation materials development (development of materials that will not become highly radioactive in a fusion reactor).

Meeting these challenges, by their very nature, requires abroad-based program of scientific, technical, and industrial R&D.

Under plans established a few years ago, **tens of billions of dollars and about three decades of continued successful R&D will be needed before the science and technology are sufficiently advanced to enable construction of DEMO following ITER, and a subsequent commercial prototype may be operational only by around 2040.** It is worth noting that fusion researchers have long suggested a three-decade horizon for development of fusion energy. As budgets have not met the expectations of researchers, and as the science has proven challenging, the horizons have continued to recede.

Congress will **face tough decisions about budget priorities for the fusion energy program over the next few years, as current plans for pursuing the tokamak imply a doubling or more from fiscal year 1995's funding of \$373 million (see figure 2-8 in chapter 2).** The budget increase has not been explicitly stated in previous

<sup>9</sup>Note that the amount of power consumed in heating the plasma is only part of the power actually consumed by the entire experiment. Losses incurred in generating the heating power and delivering it to the plasma are not included, nor is the power needed to operate systems such as the magnets and the vacuum system.

<sup>10</sup>In discussing results of scientific experiments, fusion scientists often use the term "equivalent plasma conditions." This term refers to the development of a plasma not composed of fusion fuel (e.g., a mixture of deuterium and tritium, D-T) but rather of a plasma that is easier to work with (e.g., deuterium alone). While fusion reactions can occur in the deuterium-only plasma, far less energy is produced than with D-T. Thus, equivalent breakeven conditions refers to temperatures, densities, and confinement times in a plasma that would have resulted in true breakeven had such conditions been attained with fusion fuel. Using this definition, Europe's large tokamak, JET, has achieved the breakeven level in an equivalent deuterium plasma.



DOE budget submissions, but is implied by new facilities identified by DOE and continuation of the base program. Fusion researchers have long identified the need for substantially larger research budgets, but congressional priorities have varied with changing energy markets and other factors, leading often to uncertain and fluctuating budget prospects. For example, the Secretary of Energy's Fusion Policy Advisory Committee indicated in 1990 that the fusion energy budget would need to be increased to about \$700 million annually in fiscal year 1990 dollars (not including the Defense Programs research in inertial confinement fusion) to meet program goals, but the budget since then has been at only about one-half that level (see figure 2-1 in chapter 2).

**By far the greatest single budgetary requirement for the fusion energy program over the next decade will come from ITER, if current plans are pursued.** No decision has been made by the ITER partners on whether to proceed beyond engineering design and to actually build the device. However, if ITER is pursued according to the current proposed schedule, the U.S. contribution to construction alone could require nearly a doubling of the current total fusion energy program budget over the next few years. For example, although construction costs remain uncertain, assuming the United States bears a one-quarter share to build an approximately \$10 billion ITER over an eight-year construction horizon implies an average ITER construction budget alone that is over \$300 million annually, or over 80 percent of the entire current U.S. fusion energy program budget. Unless the budget is greatly increased, it will not be possible to complete the ITER project as currently envisioned.

Finally, the information and analyses needed to support congressional decisions on fusion energy budgets and policy are not readily available. **Despite congressional requirements in the Energy Policy Act of 1992, as of December 1994, DOE has not issued a strategic management plan for the fusion energy program by which the program's progress can be judged.** The management plan was required to be prepared by April 1993 and progress reports on meeting the plan

milestones were to be updated biennially. The plan is to include specific program objectives, milestones, schedules, and cost estimates for technology development, program management resource requirements, and an evaluation of international fusion programs.

Undoubtedly one of the greatest challenges to developing the strategic management plan is the need to address the longstanding divide between the expected budgetary requirements of the fusion energy program and the history of funding at substantially lower levels. Because pressures to contain and reduce overall federal spending are likely to continue, the budgets needed to carry out the fusion energy program as currently envisioned may not be realized. **Without substantial funding increases, the program will have to change significantly from the current direction and new goals will have to be set.**

## FINDINGS ON TPX

**TPX is intended to provide scientific and technical advances that are clearly necessary to the ultimate realization of a tokamak powerplant.** With regard to scientific issues, TPX is designed to demonstrate and operate at long-pulse or near-steady state conditions, essential for an eventual powerplant. TPX is also designed to explore advanced operating modes or regimes that, if successful, would allow increases in confinement efficiency and power density in future tokamaks, and ultimately reduce the size and cost of a tokamak fusion energy reactor. With regard to technological advances, TPX would be the first large fully superconducting tokamak (i.e., the magnets will be superconducting, greatly reducing the amount of electrical power they consume). This would be a substantial achievement, and is essential for steady-state operation of an MFE powerplant. TPX would also allow investigation of a variety of configurations for the divertor, a major component essential in any eventual tokamak energy powerplant for removing both reaction products (e.g., helium "ash" produced by fusion) and heat. Remote handling, necessary for maintenance in a radioactive environment created by fu-

## 10 | The Fusion Energy Program: The Role of TPX and Alternate Concepts

sion reactions, would also be developed for maintenance of mildly radioactive equipment where limited human intervention will still be possible.

**TPX is also intended to maintain the strength of the U.S. magnetic fusion energy program after TFTR retires in 1995.** There are several other U.S. tokamaks operating currently, the largest of which are the DIII-D at General Atomics in San Diego and Alcator C-Mod at the Massachusetts Institute of Technology. However, absent TPX, there will be no new U.S. tokamak under development. To support a strong MFE research and development capability, TPX has been organized as a national facility with design and operation guided by members from various universities, national laboratories, and U.S. industries. Proponents note that experience with building major TPX systems such as the superconducting magnets could give U.S. industry a firmer base in competing to construct ITER. They also note that both Japan and Europe have large tokamaks that can continue operations for several years beyond the retirement of the U.S.' TFTR, supporting their base tokamak programs until the next steps are decided for ITER. Note, however, that TPX would not be operational before the year 2000, and so could provide design and construction benefits but not experimental benefits before them.

**TPX is not scheduled to provide any unique scientific and technological advances essential to ITER.** Indeed, when the ITER conceptual design activity was completed in 1991, DOE had no formal plans to build TPX or a device like it, although a steady-state advanced tokamak was recommended by the Fusion Policy Advisory Committee as one of four major facilities needed prior to the construction of a demonstration fusion reactor. Also, under current plans, TPX will be-

come operational only after the start of ITER construction, greatly reducing the ability to transfer TPX experimental results to ITER design. No other partner in the ITER project has found it essential to pursue a device with TPX's capabilities as part of the program for successful development of ITER.<sup>11</sup> The ITER design group indicates that it intends to provide the flexibility in ITER to examine most of the technology and science areas to be examined by TPX. The ITER interim design, expected in June 1995, should allow a better assessment of whether this is indeed the case.

**One area in which TPX may produce unique scientific benefits concerns the investigations of specific steady-state, advanced operating modes.** Currently, ITER is being designed with more conservative operating modes than TPX. However, the ITER design group has indicated its intent to maintain the flexibility to examine a range of advanced modes approaching those of TPX in the later phases of its experimental effort. Building in this flexibility may be expensive, though, as significant upgrades to auxiliary systems may be required. Again, the ITER interim design should allow a better assessment of the degree of flexibility and its costs. Whatever the extent of flexibility built into ITER, TPX could provide unique benefits. To the extent that ITER's flexibility is limited, TPX could play an important scientific role in examining the advanced operating mode issue. On the other hand, even if wide flexibility would be built into the ITER design, TPX results may help identify certain unpromising approaches and thereby help avoid performing unpromising retrofits or upgrades to ITER. This could be important since testing in ITER of some advanced operating modes examined in TPX could require a potentially costly reconfiguration of ITER.

---

<sup>11</sup> The Japanese have also carried out a conceptual design of a superconducting machine called the JT-60 Super Upgrade (JT-60SU). It would have many of the features planned for TPX and would be larger and more powerful. However, construction has not been approved, and is not expected prior to decisions about siting and construction of ITER. Note also that both Europe and Japan currently have large, relatively young tokamaks that will continue to provide a major focus for their own programs for several years. In contrast, the largest U.S. tokamak, TFTR, is scheduled to retire in 1995.

**TPX's primary expected contribution to ITER would be the ability to perform experiments on a device that is smaller, more flexible, and less costly to operate.** Because of the scheduling overlap between the projects, it will be impossible to take full advantage of the potential TPX results in the design and construction of ITER. For example, as noted above, some potentially costly decisions to build flexibility into ITER design allowing examination of advanced operating modes will be made long before TPX experimental results would be available. There may be some construction benefits as, for example, industrial experience gained from TPX construction may be useful preparation for ITER construction.

A more important potential benefit concerns decisions on possibly costly retrofits to ITER to examine advanced operating modes, as discussed above. There are other potentially important benefits in the area of ITER operations. For example, TPX experiments in long-pulse operation may shorten the needed schedule for such experiments at ITER, allowing ITER to move more quickly into research areas for which it is uniquely suited. The cost and schedule savings could be substantial, given ITER's likely high operating costs and lower flexibility relative to TPX. For example, annual operating costs for ITER, while still undetermined and highly uncertain, may be on the order of several hundred million dollars. However, the likely acceleration in the ITER operating schedule enabled by TPX remains speculative. Overall, **while the potential benefits of TPX to ITER can be real, their magnitude is uncertain, and DOE has not estimated their value. Further, there are no plans to account for the benefits of TPX to ITER as part of the direct contribution to the U.S. commitment to ITER.**<sup>12</sup>

**Unless tested in ITER, there will likely be considerable uncertainty of the transferability**

**of TPX results to DEMO.** There is no question that successful achievement of many of the goals to be investigated by TPX—steady-state operation, superconducting magnets, remote handling, and advanced divertor design in particular—will be necessary if a tokamak-based fusion power reactor is to become a reality. These areas can be incorporated in ITER from the start or be integrated into it after testing in TPX or elsewhere. Integration of advanced tokamak operations results into ITER, however, may be more limited and require significant upgrades. Since successful demonstration of these operations can have significant consequences for the economics of a fusion power reactor using the tokamak concept, it will be important to build them into the DEMO design. To the degree that advanced regime operation will not have been tested in a long-pulse ignited device, a difficult decision will eventually be needed to balance the scientific risk of incorporating that feature in an expensive facility such as DEMO against the benefits of smaller size and lower cost.

**The value of TPX to the magnetic fusion energy program could increase if ITER is delayed.** The physics and technology TPX would investigate are fundamental for the development of any tokamak powerplant, but the prospects for success are by no means certain. However, incorporating the results of the TPX advanced operating mode experiments in the design of ITER would require a several-year delay of ITER design and construction. While many of the steady-state and advanced operating regime issues to be investigated by TPX are unique to the tokamak concept, the results of technology development could also be useful to other MFE concepts. For example, operation of superconducting magnets, divertors, and remote handling will be necessary on any eventual MFE reactor.

Overall, TPX is a costly undertaking that continues to receive considerable congressional attention. However, it presents only the most im-

<sup>12</sup> This is consistent with the policy of the ITER partners that physics research performed by the partners in support of ITER is not counted against commitments to ITER design and construction.

## 12 | The Fusion Energy Program: The Role of TPX and Alternate Concepts

mediate example of a series of difficult decisions that Congress and DOE will have to make about the fusion energy program. Its budget of about \$2 billion including construction and operation over the next 15 years<sup>13</sup> represents only about 5 to 10 percent of the likely total U.S. MFE research budget needed to enable a commercial prototype tokamak powerplant by the year 2040. **Regardless of decisions on TPX, the overall tokamak fusion energy effort will require justifying a series of expensive research activities, of which the U.S. contribution to ITER presents the largest single budgetary requirement in the near future.**

### FINDINGS ON ALTERNATE CONCEPTS FOR FUSION ENERGY

Over the past several decades, the tokamak has clearly emerged as the most scientifically successful MFE concept with unmatched plasma temperatures, densities, and confinement times. It is the focus of U.S. and world fusion energy programs. There are, however, a number of alternate fusion concepts<sup>14</sup> for which the knowledge base is more limited (as shown in table 4-1 in chapter 4). These include several non-tokamak MFE concepts, some of which have been extensively pursued—such as the stellarator, a close variation of the tokamak.<sup>15</sup> Several other MFE concepts including mirrors, reversed field pinch, and the field reversed configuration have been examined less thoroughly. Scientific exploration of IFE concepts has been extensively pursued primarily for

reasons related to nuclear weapons. However, the total research effort devoted to inertial fusion, including both defense and civilian programs, makes IFE the largest alternate approach to fusion in the United States. A number of more novel fusion energy concepts have been suggested that take fundamentally different, and more speculative, approaches including muon catalysis, electrostatic confinement, and colliding beams.

**Over the past several years, the fusion energy program was substantially narrowed to focus on the tokamak primarily for budgetary rather than technical reasons.** This narrowing was partly a response to congressional pressure.<sup>16</sup> As noted by DOE in its fiscal year 1993 budget request:

... [F]iscal constraints have required the program to prematurely narrow its focus to the tokamak concept, including tokamak improvement activities, and to eliminate major alternate magnetic confinement program elements.

Operation of several existing experimental devices was halted or minimized. In one example, construction of the LSX, a \$14-million device to test the field reversed configuration, was completed in 1990 followed by encouraging startup tests, but funding to continue confinement experiments was not available. In another example, construction of a 75-percent-complete, \$75-million device to test another promising concept, the reversed field pinch, was canceled in 1990. Similarly, in fiscal year 1994, the civilian IFE budget was reduced by 50 percent to \$4 million, well be-

<sup>13</sup> The total construction cost of TPX, estimated to be \$694 million in as-spent dollars, was planned to be spent by fiscal year 2000, with a peak of about \$130 million to \$140 million each in fiscal years 1996 to 1998. However, while Congress appropriated funds in fiscal year 1995 for acquisition of major TPX systems, it restricted funds to begin construction. As of December 1994, DOE had not identified the impact of the restriction on the overall cost and schedule of TPX. DOE projects annual operating costs of about \$150 million in fiscal year 2000 dollars for the 10-year life of the facility once operations begin.

<sup>14</sup> In this report, the term “alternate concept” has the meaning “nontokamak concept.”

<sup>15</sup> Japan is currently completing the construction of a stellarator, the Large Helical Device, at a total cost of about \$1 billion. Germany is pursuing a stellarator of similar size and cost.

<sup>16</sup> See, e.g., “Conference Report on the Energy and Water Development Appropriations,” H. Rept. 103-292, *Congressional Record* 139:H7906, at p. H7948, Oct. 14, 1993 (daily ed.).

low the level needed to continue work developing a planned heavy ion driver device despite successful operations on a smaller test facility.<sup>17</sup>

There were, of course, technical reasons that the tokamak was retained as the primary focus—none of the alternate MFE concepts had attained similar performance, and a variety of technical challenges and uncertainties remained. However, **there is a widely held view that the narrowing of the fusion energy program was premature and did not reflect the benefits of pursuing alternate concepts.** The view that examination of alternate fusion confinement concepts is an important component of a fusion energy program is held even by many supporters of the tokamak, including DOE. There are clear reasons for supporting an alternate concepts program as part of the fusion energy program. Among them is that **pursuit of promising alternate concepts, including novel ones, may provide a fusion energy option should the tokamak prove technically infeasible or commercially unattractive.** It is important to note, however, that in many cases the knowledge base is not adequately developed to determine whether some alternate concept is likely to exceed the performance of the tokamak. **Data and theory do not currently support large-scale experimentation for any alternate MFE concept other than the stellarator.**

The necessary dependence on experimental facilities and research to verify theory can make fusion energy concept development expensive. **DOE suggests that a “healthy, but constrained” alternate concepts program would require about \$100 million per year.** This effort would include construction and operation of some intermediate-scale facilities. **However, a substantial amount of information that provides a firmer basis for making future alternate concept decisions could be developed with a far more modest program.** For example, some fusion researchers have proposed a broad-based

theoretical study of a wide range of alternate concepts that could be performed for less than 1 percent of the fusion energy program budget. This could help in identifying attractive prospects for additional development efforts, or for discarding some concepts as not showing substantial promise as the most attractive fusion energy device. While each alternate concept has its own development profile, next steps need not necessarily cost a substantial fraction of the fusion energy program budget. For example, experiments on existing reversed field pinch and field reversed configuration devices could be resumed and increased for under \$5 million dollars, providing considerable insight into the prospects for these promising but still speculative concepts. Also, next steps on intermediate-scale facilities need not necessarily be conducted by the United States alone, but might be undertaken through collaborative international efforts.

IFE using a heavy ion driver is widely considered the primary alternate concept, and involves the costliest next steps. However, **proponents suggest a development path for the heavy ion driver IFE concept leading to a demonstration powerplant that could be substantially more flexible and less costly than that planned for the tokamak development effort.** There is considerable scientific and technical uncertainty with IFE, and development costs are uncertain as well. Overall, some IFE proponents envision a \$4-billion civilian effort (with another \$4 billion from defense programs) spread over a number of moderate-cost facilities resulting in a demonstration powerplant. In contrast, design, construction, and operation of ITER alone is expected to cost well in excess of that amount, and is only one of the major future research activities involved in the tokamak development program. There remain considerable scientific and technical challenges with heavy ion IFE, however, and the estimated cost of the effort

<sup>17</sup> The budget for the DOE Defense Program inertial confinement fusion program, which performs much of the research relevant to IFE, was not affected.

## 14 The Fusion Energy Program: The Role of TPX and Alternate Concepts

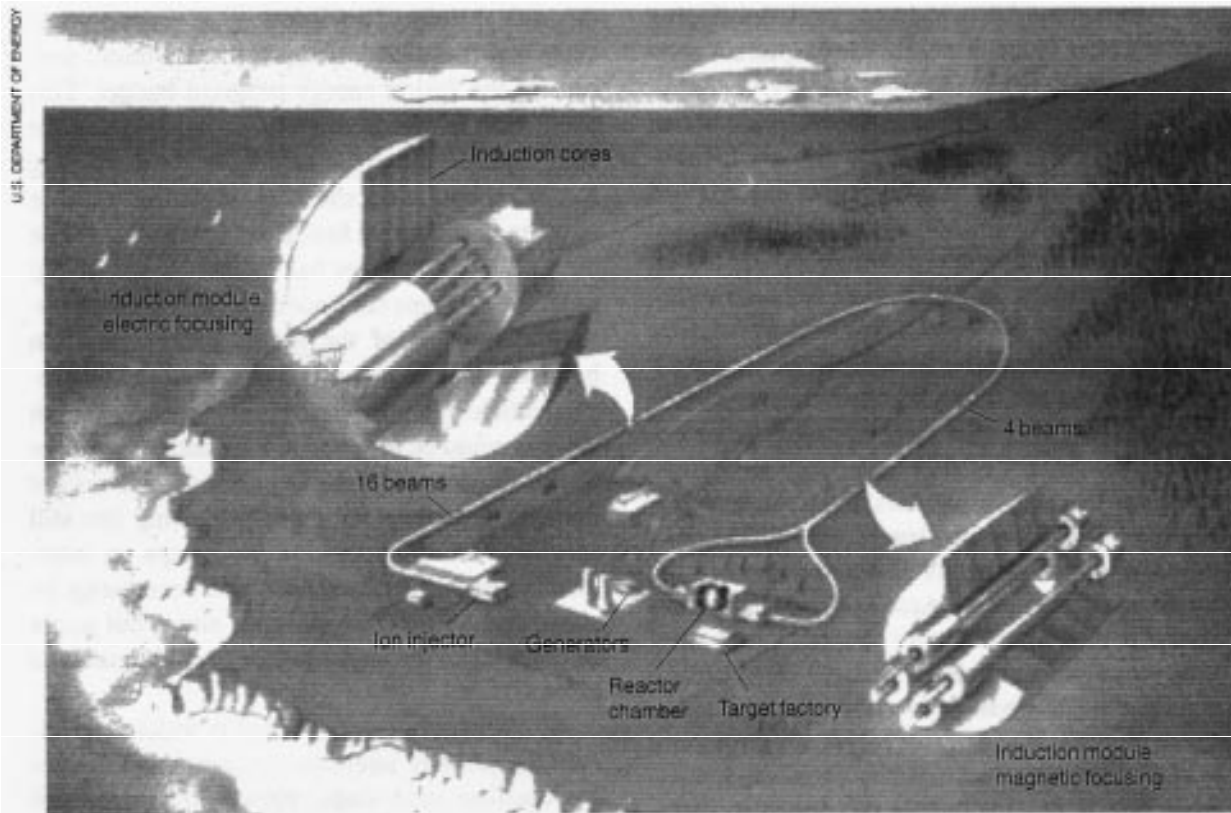

A conceptual inertial fusion energy powerplant using a heavy-ion induction linear accelerator.

could rise significantly as more experience is gained.

One critical issue with IFE is its relationship to the considerably larger inertial fusion program now included within the nation's nuclear weapons programs. This relationship provides an advantage for the IFE effort, in that much of the funding for basic scientific research needed has come under DOE's defense program. The next major step in IFE development is to explore ignition physics, a topic also relevant to maintaining nuclear weapons expertise. The IFE development plans assume completion of the National Ignition Facility (NIF), a proposed \$1-billion research facility being considered under the Defense Program at DOE as part of the stockpile stewardship program

to maintain expertise in nuclear weapons physics. Whether NIF is constructed will probably depend more on weapons-related reasons, including its role in maintaining nuclear weapons design expertise and the potential effects on weapons proliferation, and budget considerations rather than its benefits for the fusion energy program.<sup>18</sup>

**In summary, while alternate concepts provide no panacea for fusion energy development, there is merit in examining them as part of a broad fusion program** Relative to the expected costs of the tokamak effort, a great deal of exploratory work can be conducted at modest cost. Assuming some of the concepts prove technically promising, however, further development

<sup>18</sup>In October 1994, the Secretary of Energy approved NIF for engineering design (Key Decision 1, or KD-1). The primary mission of NIF is to demonstrate inertial fusion ignition and modest energy gain.

may require larger budgets for construction of expensive facilities. As with the tokamak effort, the potential role of the overall fusion energy program in meeting long-term energy needs, and the level

of research effort justified by that potential role, are critical issues for the direction of alternate concepts research.

# The Federal Fusion Energy Research Program 2

**A**fter more than 40 years of federally supported research into fusion energy, researchers have made substantial strides in the understanding of plasma physics and in the design and operation of controlled fusion reactions in the laboratory. Many more scientific and technical challenges remain to be overcome before fusion energy's scientific and engineering feasibility can be conclusively established. Most researchers believe that, even if current research and development (R&D) plans are fully funded and technically successful, commercial generation of electricity from fusion powerplants still remains decades away.<sup>1</sup> Even then, fusion's economic feasibility as a power source will be determined in large part by the availability, costs, and public acceptability of competing fossil, fission, and renewable energy technologies.

The U.S. Department of Energy (DOE) sponsors fusion research under two separate programs on magnetic fusion and inertial confinement fusion. DOE's fusion energy research programs have been heavily reviewed over the years. Most reviews have complimented the steady technical and scientific progress achieved. Over the past decade, however, several major reviews have expressed concern about the narrowing scope of the magnetic fusion energy program, the lack of support for research on alternate concepts, and the adequacy of funding to carry out even narrow program objectives on the scales and schedules proposed. Fusion's potential attractiveness as an energy source has contin-

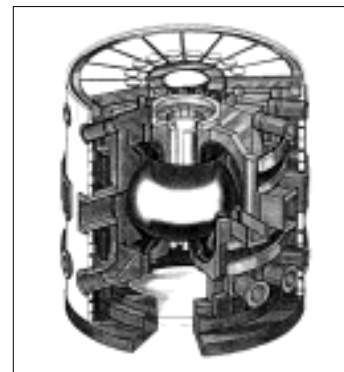

---

<sup>1</sup> Commercial power generation has been a major goal of government fusion research almost from the beginning, however, other potential applications of fusion technology have been suggested, such as space propulsion, for example.



ued to garner political and financial support in the United States and in foreign nations, despite its uncertain future.

The Energy Policy Act of 1992 committed the nation to a five-year “broad-based” fusion energy program “that by the year 2010 will result in a technology demonstration which verifies the practicability of commercial electric power production.”<sup>2</sup> The DOE magnetic fusion program has proposed moving forward with a major new domestic fusion experiment, the Tokamak Physics Experiment (TPX), the first new U.S. tokamak in two decades. The United States has also been engaged in an ongoing collaboration on the engineering design of the International Thermonuclear Experimental Reactor (ITER), a machine that is intended to reach the critical milestone of an ignited fusion plasma and provide an engineering test bed for reactor components needed to design a demonstration fusion powerplant. Design and construction costs for the ITER facility are currently estimated on the order of \$10 billion; more precise preliminary cost projections for building and operating ITER are scheduled to be available in summer 1995. Final cost estimates will not be made until after a site has been selected. Under the current ITER agreement, there is no commitment by any of the parties to proceed beyond the engineering design activities phase. If constructed, ITER would be funded, built, and operated as an equal partnership with the Japanese, Russian, and European Community fusion programs and marks an unprecedented level of cooperation in a large science and technology project. Recently, the ITER parties have begun discussions on a possible collaboration on a fusion materials irradiation facility.

This chapter provides an overview of the federal fusion research program, its history, legislative authority, goals and organizational structure.

### HISTORY OF U.S. FUSION ENERGY RESEARCH

#### ■ Early Years: 1950 to 1970

U.S. research on controlled fusion for energy purposes began in 1951 as an offshoot of classified weapons-related research under the Atomic Energy Commission’s Project Sherwood. Over the decade, federal dollars supporting research in fusion and the new “plasma physics” grew and research programs were established at national laboratories, universities, and several private companies.<sup>3</sup> Initially, fusion research was pursued with the objective of using fusion reactions to produce plutonium and tritium for nuclear weapons, but later discovery of ample domestic uranium resources eliminated this objective. However, early on, many scientists became intrigued with the prospects of fusion as a nearly inexhaustible energy source. Researchers of the time believed that harnessing fusion would not be an especially difficult challenge, requiring perhaps one or two decades to develop a fusion reactor. The key would be discovering a “magnetic bottle” that could contain the fusion reaction. During the 1950s, several magnetic confinement approaches were investigated, including mirrors, stellarators, and pinches, but, in all of them, researchers encountered instabilities in the plasmas that limited the confinement times, temperatures, and pressures. It also became more widely apparent that progress in the science of fusion plasmas and development of a commercial fusion

<sup>2</sup> Public Law 102-486, Oct. 24, 1992, 106 Stat. 2776, at section 2114, 106 Stat. 3073-3074 (codified as 42 U.S.C. 13474).

<sup>3</sup> For more on the history of the fusion program, see U.S. Congress, Office of Technology Assessment, *Starpower: The U.S. and the International Quest for Fusion Energy*, OTA-E-336 (Washington, DC: U.S. Government Printing Office, October 1987), ch. 3; and Committee on Magnetic Fusion in Energy Policy, Energy Engineering Board, Commission on Engineering and Technical Systems, National Research Council, *Pacing the U.S. Magnetic Fusion Program* (Washington, DC: National Academy Press, 1989).

power reactor would be a long and expensive undertaking.

In 1958, the United States declassified fusion research as a result of the Second Geneva Convention on the Peaceful Uses of Atomic Energy and opened the door to international cooperation among U.S., Soviet, and European fusion researchers. Since then, international cooperation has grown from informal contacts among scientists and exchanges between research laboratories to formal collaborative agreements between government programs and to the ongoing collaboration on the design of ITER.

During the 1960s, research continued on plasma physics and ways of overcoming instabilities in the plasma to improve confinement times and densities, but progress was very slow. By the second half of the 1960s, government and private interest in fusion R&D was waning. Then, in the late 1960s, the Russians announced significant advances in confinement conditions using their tokamak concept. Conflation of the tokamak results gave renewed impetus to fusion energy research activities overall and resulted in a redirection of research efforts in the United States, Europe, and Japan. The United States converted a stellarator to tokamak configuration and built several new small tokamaks at Oak Ridge National Laboratory, Massachusetts Institute of Technology, and General Atomics in San Diego.

### ■ The 1970s: Program Expansion

Fusion research funding expanded substantially from \$34 million in 1970 to over \$350 million in 1979 as shown in figure 2-1. These increases were part of the overall expansion of federal energy R&D in response to the 1973 OPEC oil embargo and reflected the optimism generated by the relative successes of the tokamaks and the belief that fusion technologies ultimately could prove more publicly acceptable on environmental and safety grounds than competing nuclear fission reactors. In the reordering of federal energy research activities in 1974, fusion energy research activities of the Atomic Energy Commission became part of the Energy Research and Development Adminis-

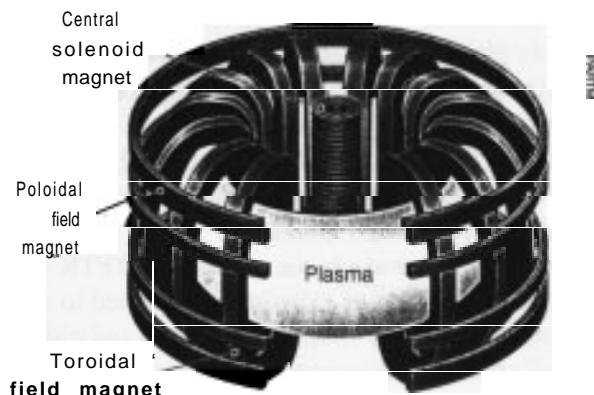

*Tokamak magnets. A tokamak uses three types of magnets. Toroidal field magnets create a "container" for the plasma, while poloidal field magnets keep the plasma centered and stable. The central solenoid magnets induce an electric current in the plasma.*

tration, which was later absorbed into the new Department of Energy in 1977. Magnetic fusion and inertial confinement fusion energy activities remained in separate programs.

The U.S. magnetic fusion program supported a broad range of research activities. The tokamak continued to be the most technically advanced of the magnetic confinement concepts and a number

**FIGURE 2-1: Magnetic Fusion Program Funding, 1952-Present (in nominal dollars)**

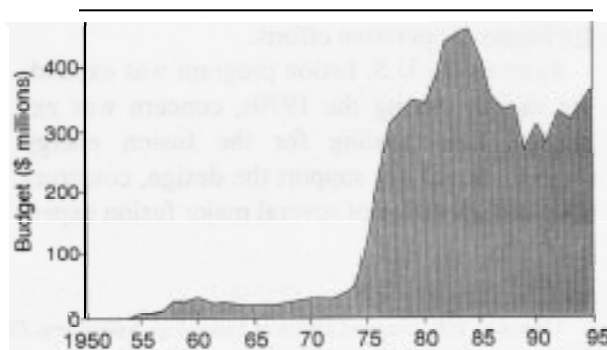

SOURCE: Office of Technology Assessment, 1995, based on historical information from the U.S. Department of Energy, and budget documents.

of small and mid-size tokamak fusion reactors were placed in operation in U.S. research laboratories and many continue operating today. Construction of a major new machine, the Tokamak Fusion Test Reactor (TFTR) was begun at the Princeton Plasma Physics Laboratory (PPPL). The TFTR remains among the largest and most advanced tokamaks in the world. The TFTR was to pursue a series of experiments planned to culminate in the early 1980s in deuterium and tritium (D-T) reactions that could approach or even reach the key fusion milestone of breakeven. At the same time, the program expanded the exploration of alternative confinement concepts as well as research into the various reactor-related component technologies and materials that would be needed for eventual commercial fusion power systems. Fusion energy research programs were supported at a number of national laboratories and universities, and the program provided support for training the majority of the plasma physicists in the United States. In 1976, design and construction began on a second major fusion experiment, the Mirror Fusion Test Facility B (MFTF-B) at Lawrence Livermore National Laboratory, that was intended to compete with the tokamak concept.

The 1970s also marked the beginning of ambitious fusion R&D programs in Japan and the European Community with commitments to construction of major new tokamak facilities and significant increases in research budgets. International collaboration among fusion researchers also expanded during this period, setting the stage for future cooperative efforts.

Even as the U.S. fusion program was expanding rapidly during the 1970s, concern was expressed that funding for the fusion energy program could not support the design, construction, and operation of several major fusion exper-

imental machines as competitors to the tokamak, and that the focus on tokamaks was prematurely narrowing the search for an attractive commercial reactor confinement concept.<sup>4</sup> Although the tokamak was delivering promising results in the laboratory, questions raised about its ultimate acceptability as a design for a commercial power reactor continued to spur interest in development of alternative concepts. An outside review of the ambitious DOE fusion energy research plan in 1978 supported the redirection of the program toward development of fusion power reactor technology and endorsed the concept of a “two-horse race” between the tokamak and mirror concepts that could be expanded to include other serious contenders as they emerged.<sup>5</sup> A 1980 review by the DOE Energy Research Advisory Board (ERAB) recommended that the fusion program should proceed to development of a next-step engineering test reactor and called for a doubling of the magnetic fusion budget over the next seven years. These recommendations were subsequently embodied in the Magnetic Fusion Energy Engineering Act of 1980.<sup>6</sup>

### ■ The 1980s: Technical Progress and Declining Budgets

In the 1980s, the sense of urgency generated by the 1970s “energy crisis,” which had pushed the program to develop a fusion demonstration powerplant, rapidly abated, and funding began to decline. Policy shifts and growing budgetary pressures contributed to a de-emphasis on research on alternative concepts and the cancellation, mothballing, or shut-down of a number of major experimental facilities. Throughout the 1980s, the magnetic fusion program underwent a series of management reviews and redirections as budgets

---

<sup>4</sup> See, e.g., U.S. Congress, Office of Technology Assessment, *Comparative Analysis of the 1976 ERDA Plan and Program*, OTA-E-28 (Washington, DC: U.S. Government Printing Office, May 1976), pp. 98-102; and reports cited in Committee on Magnetic Fusion in Energy Policy, *op. cit.*, footnote 3, pp. 18-39.

<sup>5</sup> Committee on Magnetic Fusion in Energy Policy, *op. cit.*, footnote 3, citing U.S. Department of Energy, Review Committee on the Magnetic Fusion Energy Program, “Final Report,” DOE/ER-0008, June 1978.

<sup>6</sup> For a discussion of this act, see the next section of this chapter.

continued to decline in real terms. As a result, the program began to be increasingly focused on gaining approval and funding for an advanced tokamak successor to the TFTR and for its involvement in an international collaboration to build an ignition tokamak. That focus continues today.

The Reagan Administration held markedly different views of the appropriate role of federal energy R&D activities than did its predecessors, and sharply reduced the budgets of many energy research programs. However, because it was undeniably targeted at high-risk, long-term research, the magnetic fusion program fit more closely with the new administration's priorities than fossil, renewable, and energy-efficiency research projects that were focused on nearer term commercial efforts. Consequently, the fusion budgets fared better than some other programs during the Reagan years. The fusion program budget actually increased in nominal dollars to peak at \$468 million in fiscal year (FY) 1984 before it began its decline. (According to an analysis by DOE using special "high energy physics" equipment and construction indices, the fusion program funding peaked in real terms in 1977 and thereafter failed to keep progress with inflation. By 1988 the magnetic fusion program funding had effectively been cut to half of what it was at its 1970s peak).

DOE's 1983 Comprehensive Program Management Plan (CPMP) for the fusion program (required by the Magnetic Fusion Energy Engineering Act of 1980—MFEEA) reflected the Reagan policies and explicitly ruled out a government-built demonstration reactor. The CPMP defined the mission of the fusion program as supporting research that would allow selection of a confinement concept for further development by the private sector and to allow a decision to build an engineering test reactor by 2000.

The CPMP was strongly criticized by the fusion technical advisory committee of ERAB in its first triennial review of the fusion program required under MFEEA. The panel concluded that program budgets would not allow the CPMP goals to be met, and that the proposed schedule would force a premature choice between the competing mirror and tokamaks concepts, and could delay progress on tokamak advances. Moreover, it called for construction of an engineering test reactor (ETR) before necessary technology would be available. The panel recommended a redirection of the program to delay construction of an ETR, allow construction of a tokamak successor to TFTR to study ignition and burning plasma physics issues, and to maintain a strong innovative program in plasma physics, technology development, and alternate confinement concepts.<sup>7</sup>

In 1985, responding to these criticisms and others, DOE issued a revised Magnetic Fusion Program Plan (MFPP) that states that "the goal of the magnetic fusion program is to establish the scientific and technological base required for fusion energy."<sup>8</sup> This goal has remained the central mission of the fusion program ever since. The MFPP reduced the emphasis on reactor development that had characterized the 1983 plan and concentrated on the science and engineering requirements. It laid out several key technical issues to be resolved by the fusion energy program, recommended construction of a compact ignition tokamak (CIT) to explore the physics of ignited plasmas, and established a goal of international collaboration rather than international leadership. Like the CPMP, it too, precluded government construction of a demonstration reactor. ERAB's second triennial review of the fusion energy program endorsed the direction and strategy in the 1985 plan. The panel raised concerns over the potential impacts

<sup>7</sup> Technical Panel on Magnetic Fusion of the Energy Research Advisory Board, *Magnetic Fusion Energy Research and Development*, final report, DOE/S-0026 (Washington, DC: January 1984).

<sup>8</sup> U.S. Department of Energy, Office of Energy Research, *Magnetic Fusion Energy Program Plan*, DOE/ER-0214 (Washington, DC: February 1985), executive summary.

on the program of proceeding to construct the CIT under constrained budgets and recommended that the CIT be funded as an increment to the MFE budget.

By 1986, budget constraints were already taking their toll on the breadth of the fusion program leading to project cancellations and cutbacks (see figure 2-2). The huge \$330-million tandem mirror experiment at Lawrence Livermore National Laboratory, the MFTF-B, was mothballed almost immediately after its completion in 1986 without ever operating as a fusion facility. DOE determined that it could not operate both the MFTF-B and its competitor, the TFTR at Princeton, with available funds.<sup>9</sup> Earlier, DOE canceled the Fusion Materials Irradiation Test Facility at Hanford, Washington, which was to support advanced materials development. Funding constraints also led DOE to defer the start of the critical D-T experiments in the TFTR. In 1987, construction was completed on the Advanced Toroidal Facility (ATF) at Oak Ridge National Laboratory, then the world's largest stellarator, but funding problems limited the extent of its experimental operations from the start. Work was allowed to continue on construction of a smaller, and less-expensive, reversed field pinch device at Los Alamos National Laboratory.

During the 1980s, international collaboration efforts grew as DOE pursued the negotiation of an international initiative for the joint design, construction, and operation of an engineering test reactor as equal partners with the Japanese, Soviet, and European Community fusion programs. The ITER effort began as a result of discussions between President Reagan and Soviet Leader Gorbachev at the 1985 Geneva summit. An agreement to work jointly on a conceptual design for ITER

was concluded in 1988 among the four governments.<sup>10</sup>

OTA's 1987 report, *Starpower: The U.S. and the International Quest for Fusion Energy*,<sup>11</sup> examined the magnetic fusion program and noted the substantial progress that had been made in the scientific and technical challenges of proving the feasibility of fusion power. *Starpower* found that most researchers expected that at least three decades of additional R&D would be required before a prototype commercial fusion reactor could be demonstrated. Meeting even this schedule, however, would require a substantial increase in U.S. fusion research budgets or a dramatic expansion of international collaboration in fusion research. The OTA report emphasized that important scientific uncertainties and technological challenges remained to be resolved before fusion's commercial potential could be assessed. The report further cautioned that it was still too early in the research program to determine which confinement concept would be most likely to form the basis of an attractive commercial fusion reactor, and whether once developed, fusion reactors would be economically competitive with other energy sources. These conclusions still hold today, especially as the increased funding required to pursue scientific and technical issues have not received a high priority in an era of tight federal budgets.

The impacts of funding constraints on the fusion program did not escape the attention of congressional committees. During the FY 1988 appropriations process, Congress directed DOE to submit a five-year flat budget plan that detailed how the program would support D-T experiments on the TFTR, construction of the proposed CIT, and participation in ITER conceptual design acti-

---

<sup>9</sup> At the time, there were concerns about the potential technical performance of MFTF-B because of the difficulties encountered by smaller mirror experiments in meeting their performance targets. However, budget constraints seemed to have been the decisive factor in sealing the fate of the MFTF-B.

<sup>10</sup> For more on ITER, see box 1-1 in ch. 1 of this report.

<sup>11</sup> Office of Technology Assessment, op. cit., footnote 3.

**FIGURE 2-2: U.S. Magnetic Fusion Budget and Project History, Fiscal Years 1977-94**  
(FY 1993 dollars in millions)

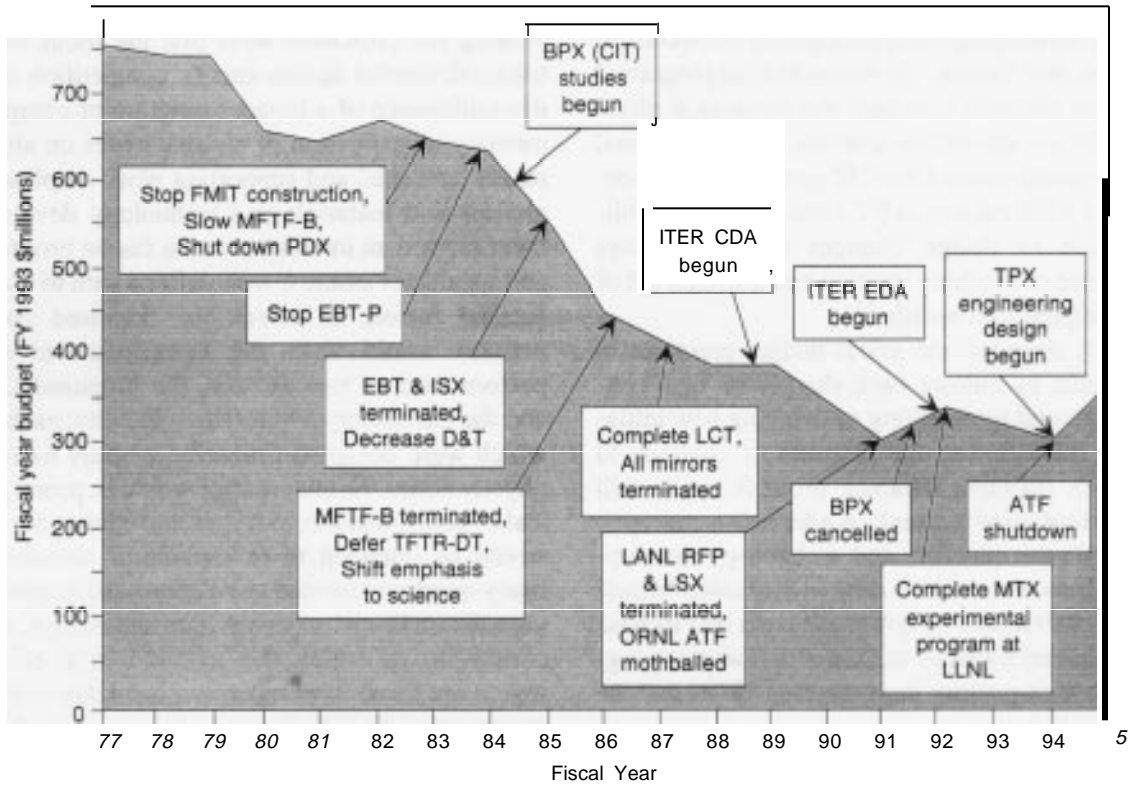

- KEY:
- BPX/CIT=Burning Plasma Experiment/Compact Ignition Tokamak
  - DT=Deuterium-Tritium
  - EBT=Elmo Bumpy Torus
  - EBT-P=Elmo Bumpy Torus-P
  - FMIT=Fusion Materials Irradiation Test Facility
  - ISX=Impurity Studies Experiment (a tokamak)
  - ITER CDA=International Thermonuclear Experimental Reactor Conceptual Design Activities
  - ITER EDA=International Thermonuclear Experimental Reactor Engineering Design Activities
  - LANL RFP=Los Alamos National Laboratory Reverse Field Pinch
  - LCT=Large Coil Test Facility (superconducting magnets)
  - LLNL=Lawrence Livermore National Laboratory
  - LSX=Large S Experiment (afield-reversed compact toroid device)
  - MFTF-B=Mirror Fusion Test Facility-B
  - MIX= Microwave Tokamak Experiment
  - ORNLATF=Oak Ridge National Laboratory Advanced Toroidal Facility (a stellarator)
  - PDX=Princeton Divertor Experiment
  - TFTR=Tokamak Fusion Test Reactor
  - TPX=Tokamak Physics Experiment

SOURCE: U.S. Department of Energy, 1994.

## 24 | The Fusion Energy Program: The Role of TPX and Alternate Concepts

vities under constant dollar funding of about \$360 million annually.

In testimony, DOE explained that CIT design and ITER activities were being funded by stretching out the CIT construction schedule, eliminating the mirror program for budgetary not technical reasons, and “taxing” the balance of the programs’ work on alternate concepts and theoretical physics.<sup>12</sup> In the meantime, internal reviews showed the projected costs of the CIT growing from an estimated \$360 million in FY 1986 to almost \$1 billion due to design changes to give greater assurance of reaching ignition and a stretch out of the completion schedule.<sup>13</sup>

DOE absorbed the initial budget pressures in the 1980s by cutting back sharply on new construction and mothballing or delaying new initiatives. This allowed the program to continue to fund the mainline tokamak projects, while still supporting some research on alternative concepts, basic plasma physics, and technology development. However, a sharp drop in the fusion budget in FY 1989 forced the program to cut into its base program and tokamak activities to continue progress on high-priority items such as TFTR and the ITER collaboration.

Budget pressures, a change in administrations, and internal reviews led to more program reviews and budget reductions. In 1989, DOE decided to defer the CIT as then planned while conducting a transport initiative, sponsored by taxing other projects, in an attempt to resolve the physics issue of heat loss from tokamaks.<sup>14</sup> Secretary Watkins

also proposed a head-to-head competition between magnetic fusion (i.e., tokamaks) and inertial fusion (see figure 2-3).

These shifts were met with criticism from many in the fusion community and Congress.<sup>15</sup> Among the criticisms were that the focus on a tokamak/inertial fusion energy competition and discontinuance of a broader program of complementary investigation of physics issues on alternative concepts, and supporting work on plasma physics and materials and technology development created an imbalance in the fusion program and would not assure a well-defined path to commercial fusion. In effect, the proposed competition would limit the comparison to the performance of two devices, the proposed CIT and the Laboratory Microfusion Facility, each of which were designed primarily to study narrow physics issues. Neither reactor would be prototypical of power reactors to follow and neither device would be intended to or capable of answering many questions needed to be addressed in selecting a future line of approach to fusion energy. According to its critics, the competition as posed would not serve its purpose and the delay in CIT construction would idle many fusion researchers and engineers.<sup>16</sup>

Secretary Watkins responded by calling for another high-level review panel to recommend a new policy direction for the fusion energy program. The panel was also tasked with conducting the third triennial review of the magnetic fusion

---

<sup>12</sup> See testimony of James F. Decker, Acting Director, Office of Energy Research, U.S. Department of Energy, and supplemental materials, in U.S. Congress, House of Representatives, Committee on Science, Space, and Technology, Subcommittee on Energy Research and Development, “Hearing on Fiscal Year 1989, Department of Energy Authorization (Magnetic Fusion Energy),” 100th Congress, 2d sess., Mar. 30, 1988, vol. vi, pp. 11-22, 97-98.

<sup>13</sup> David Crandall, U.S. Department of Energy, Office of Fusion Energy, personal communication, November 1994.

<sup>14</sup> Testimony of Robert O. Hunter, Jr., Director, Office of Energy Research, U.S. Department of Energy in U.S. Congress, House of Representatives, Committee on Science, Space, and Technology, Subcommittee on Investigations and Oversight, “Hearings on Fusion Energy Program: Status and Direction,” 101st Congress, 2d sess., Oct. 5, 1989, pp. 297-317.

<sup>15</sup> U.S. Congress, House of Representatives, Committee on Science, Space, and Technology, “Hearings on Fusion Energy Program: Status and Direction,” 101st Congress, 2d sess., Oct. 5, 1989.

<sup>16</sup> Statement of Senator Frank Lautenberg, in debate on the FY 1990 Energy and Water Appropriations Bill, *Congressional Record* (daily ed.), S8947, July 27, 1989.

FIGURE 2-3: Proposed Fusion Development Plan Showing Head-to-Head Competition Between Magnetic Confinement (Tokamak) and Inertial Confinement Concepts, Circa 1989

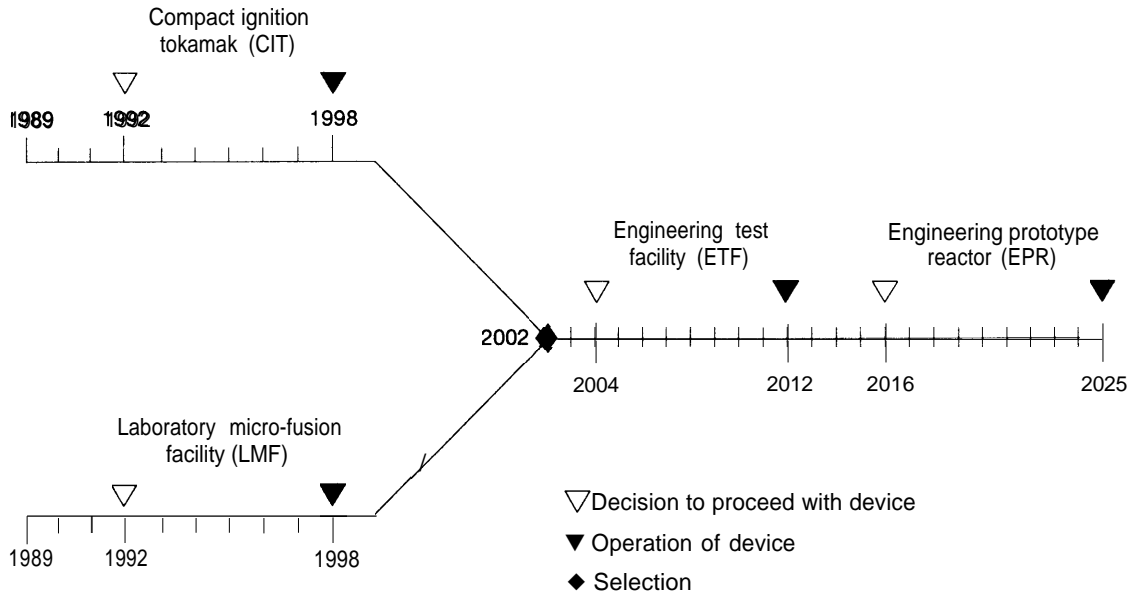

SOURCE: Testimony of Robert O. Hunter, Jr., Director, Office of Energy Research, US. Department of Energy, Attachment, in US Congress, House of Representatives, Committee on Science, Space, and Technology, Subcommittee on Investigations and Oversight, "Hearings on Fusion Energy Program. Status and Direction," 101st Congress, 2d sess., Oct. 5, 1989, p. 335.

program required under the 1980 Act. The Fusion Policy Advisory Committee (FPAC) reported back in September 1990 supporting a “responsible, goal-oriented fusion energy development program” directed at achieving the goals of “at least one operating Demonstration Power Plant by 2025 and at least one operating Commercial Power Plant by 2040.”<sup>17</sup> The committee expressed its belief that the U.S. fusion energy program was “technically ready” to construct devices to demonstrate significant fusion power production in a burning tokamak plasma and ignition in an iner-

tially confined pellet. The committee noted that attaining its conceptual goals would require an immediate ramp up in funding and, recognizing the tight budget climate, provided a number of next-step options with lower immediate effects on the fusion budget. The committee cautioned, however, that “the first funding increments for new facilities in the constrained program are essential for fusion to be an energy program. If these increments are not forthcoming, the program would remain only a research effort without rea-

<sup>17</sup> Letter from H. Guyford Stever, Chairman, Fusion Policy Advisory Committee to Admiral James D Watkins, Secretary Of Energy, Sept. 25, 1990, transmitting the committee report, reprinted in U.S. Department of Energy, Fusion Policy Advisory Committee (FPAC), *Report of the Technical Panel on Magnetic Fusion of the Energy Research Advisory Board, Final Report*, DOE/S-0081 (Washington, DC: September 1990), hereinafter referred to as *FPAC 1990*.



## 26 The Fusion Energy Program: The Role Of TPX and Alternate Concepts

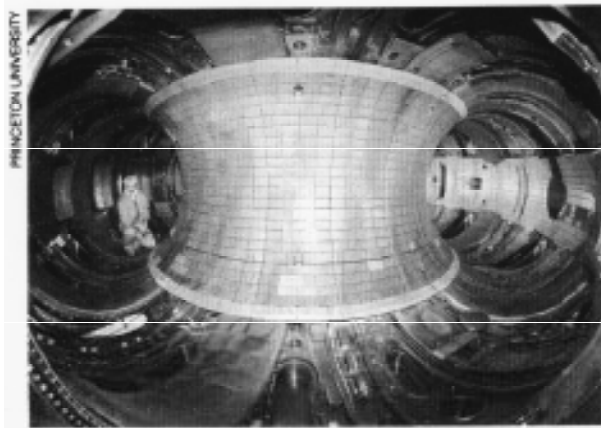

Inside the vacuum vessel of the TFTR at the Princeton Plasma Physics Laboratory Graphite and graphite composite tiles protect the inner wall of the vessel.

sonably timed energy objectives.”<sup>18</sup> FPAC made a number of specific recommendations, including:

1. The United States should commit to fusion as a potential energy source.
2. The program should support both magnetic fusion and inertial confinement fusion as distinct and separate approaches and should plan for major new facilities in each. In recommending this strategy, the FPAC report observed: “The committee affirms its belief that the two concepts are not ready for a choice of one over the other. Pursuing both options at this time reduces technological risk.”<sup>19</sup>
3. The United States should participate actively as an equal partner in the ITER engineering design activities (EDA) collaboration while maintaining a strong and balanced domestic program.
4. The U.S. fusion program should support “an independent program of concept improvement, including study, and where promising, development of alternative configurations that may be more suitable for commercialization,” plus vigorous technology and materials development.

5. The program should increase opportunities for U.S. industry participation to allow them to take advantage of fusion technology advances, while continuing involvement of universities and national laboratories.

The committee estimated that its conceptual program would require U.S. fusion program budgets (including the defense inertial confinement fusion program) to reach about \$1 billion per year in constant dollars over the period 1990 to 1997 to allow construction of essential new facilities. (Note that this estimate did not include the costs of ITER construction scheduled to begin after 1998.) Constrained budget approaches and priorities were also suggested.<sup>20</sup>

At its full budget level, FPAC called for the magnetic fusion energy (MFE) program to support participation in ITER EDA activities, completion of D-T experiments in the TFTR, construction of the Burning Plasma Experiment (BPX—an outgrowth of the previous CIT design), a modest increase in the base program, design of a new steady-state tokamak, and increased emphasis on low activation materials and nuclear technology. This recommendation would require an increase in the magnetic fusion budget from \$316 million in FY 1990 to over \$600 million in FY 1996 in 1990 dollars.

At reduced budgets, FPAC gave priority to holding the base program roughly constant, funding D-T experiments in TFTR, stretching out construction of BPX by two years, and participation in ITER. Construction of BPX/CIT was seen as making the United States a “strong and attractive partner in magnetic fusion research,” achieving an important milestone intermediate between existing facilities and ITER, and re-establishing U.S. leadership in magnetic fusion. FPAC estimated that to achieve these priorities the budget would have to increase to about \$470 million (1990 dollars) by FY 1996.

<sup>18</sup> Ibid.

<sup>19</sup> FPAC 1990, p. 4.

<sup>20</sup> Ibid., p. 5.

FPAC recognized that inertial confinement fusion (ICF) would need to remain primarily a defense program and supported as its highest priority mission, the study of target physics leading to the demonstration of pellet ignition. FPAC noted that ongoing ICF work on target physics and drivers will be beneficial for advances in inertial fusion energy (IFE). To provide more effective support for the goal of developing IFE technology, FPAC recommended that an IFE program be integrated into the Office of Fusion Energy as a separate division. The new IFE program would concentrate on efforts that would be complementary to the ICF activities—e.g., developing an efficient and low-cost driver with repetition rates of several pulses per second,<sup>21</sup> concurrent work on materials and reactor designs, and investigation of environment, health, safety, waste disposal, and decommissioning matters related to an IFE powerplant.

FPAC endorsed a suggestion by a separate National Academy of Sciences (NAS) Panel that DOE develop the heavy-ion Induction Linac System Experiments (ILSE) within the IFE program and a glass laser facility in the defense program as intermediate steps before proceeding with a proposed Laboratory Microfusion Facility.<sup>22</sup> FPAC noted that unlike the situation in magnetic fusion, the U.S. program remained the world leader in ICF offering potential opportunities to capitalize on that position if IFE proves commercial.

FPAC offered several budget priorities for ICF programs including upgrades to the Nova laser at Lawrence Livermore National Laboratory and to other existing laser facilities and continued work on target physics at an increment of about \$44 million over FY 1990 ICF budgets by FY 1991. Addi-

tional priorities, if funding were available, would be to support IFE development work on heavy-ion drivers, light-ion drivers, and krypton-fluoride lasers. This would increase the FY 1996 budget by an additional \$34 million to \$64 million over FY 1990 levels. FPAC estimated that support of IFE base program activities and construction of ILSE would require about \$90 million over five years.<sup>23</sup>

As for the general management of the DOE fusion program, FPAC recommended that fusion R&D activities be conducted in a disciplined goal-oriented manner with detailed development strategies, appropriate milestones, key decision points, and “down-selection” among competing options following adequate technical evaluations on a path to achieve a demonstration of one or more fusion powerplants by 2025. The magnetic fusion path would include ITER, a burning plasma facility and support of alternate concepts, concept improvement, and materials and technology development. FPAC also recommended that the IFE program build on advances in target physics under the defense programs while investigating several competing driver technologies, including heavy-ion drivers. An early decision would be made to pursue either a light-ion or krypton-fluoride laser alternative driver based on technical performance. At each major step, the program should be subject to rigorous feasibility and cost analysis by a qualified external group prior to approval. While recognizing that the national laboratories would continue to have responsibility for new facilities, FPAC recommended that the labs develop more effective mechanisms to work cooperatively and share responsibility while providing opportunities for more university, industry, and interna-

---

<sup>21</sup> There are several technologies under consideration as possible drivers for IFE power production including heavy-ion drivers, light-ion drivers, and krypton-fluoride lasers. Research on light ions and krypton-fluoride lasers is supported by the ICF program because of defense-related applications and experience there could be transferred to energy applications in the future. The National Academy of Sciences has remarked favorably on the potential use of heavy-ion accelerators as IFE drivers and encouraged construction of a device that could be used to demonstrate and experiment with the characteristics of a full-sized heavy-ion driver. ICF researchers in Europe and Japan are also exploring use of heavy-ion drivers, but are focusing instead on using radio frequency acceleration rather than the induction Linac approach. *Ibid.*, pp. 43-47.

<sup>22</sup> *Ibid.*, pp. 41-43.

<sup>23</sup> *Ibid.*, p. 44.

tional collaboration in the design, construction, and operation of new facilities.

An NAS committee also released a review of the priority and pace of the magnetic fusion R&D program in 1990.<sup>24</sup> The NAS panel found a loss in U.S. leadership in MFE research due primarily to the halving of program funding in constant dollars since 1977, which also led to narrowing of U.S. programs. This committee concluded that current DOE program funding levels would be inadequate to meet even the near-term objectives of the 1985 MFPP. The committee estimated that funding levels would have to be increased by at least 20 percent annually over 1990 levels in the early 1990s and by an additional 25 percent in the late 1990s to allow the U.S. program to proceed with the proposed CIT experiment and to participate in ITER construction. The committee offered several interim recommendations for the magnetic fusion program:

1. U.S. participation in an international collaboration on next-step major facilities as the most cost-beneficial U.S. approach to fusion over the next decade;
2. an increase in program funding to permit construction of CIT to allow resolution of central scientific feasibility questions and participation in construction of ITER in the late 1990s; and
3. development of a revised program plan providing greater participation by U.S. companies in activities such as design and construction of major systems and subsystems.

The committee noted that these recommendations were made without consideration of competing demands for resources from other energy technologies or national programs. The NAS panel commented on the absence of any comprehensive comparative assessment of the energy, environmental, health, safety, economic, and

institutional aspects of various competing alternative future energy technologies on which to base informed choices for overall U.S. energy research priorities.

### ■ The 1990s: Growing Internationalization and Tough Budget Choices

Secretary Watkins adopted the FPAC findings “subject to existing budget constraints.” But the funding increases recommended by FPAC and the NAS panel did not win support within DOE or in Congress. Indeed, fusion budgets continued to diminish. Budget cuts driven by deficit reduction and reprogramming took the MFE program from \$316.7 million in FY 1990 to \$273.6 million in FY 1991. According to the then-director of the Office of Energy Research:

This translated into terminating work on alternative confinement concepts and pursuing only the tokamak concept within the magnetic fusion energy program as a precursor to a Burning Plasma Experiment (BPX) that would be integrated into a larger international fusion energy program.<sup>25</sup>

Even in the face of these budget cuts, the Bush Administration released its National Energy Strategy (NES), which adopted fusion energy as an important long-range element incorporating the recommendations of FPAC. The NES fusion goals were to prove fusion energy to be a technically and economically credible energy source, with an operating demonstration plant by about 2025 and an operating commercial plant by about 2040. This would be accomplished by developing both magnetic and inertial confinement approaches to fusion separately until sufficient R&D exists to make a choice, and also by achieving early industrial involvement. The NES called for continued international collaboration and cost-

<sup>24</sup> Committee on Magnetic Fusion in Energy Policy, op. cit., footnote 3.

<sup>25</sup> William Happer, “Charge to the Fusion Energy Advisory Committee,” Sept. 24, 1991, reprinted as app. E in Fusion Energy Advisory Committee, *Report on Program Strategy for U.S. Magnetic Fusion Energy Program*, DOE\ER-0572T (Washington, DC: U.S. Department of Energy, Office of Energy Research, September 1992.) Hereinafter referred to as *FEAC*, September 1992.

sharing in the magnetic fusion program. The NES, however, explicitly recognized that:

The technical complexity associated with fusion development is such that substantial investments are required for new experiments, design facilities, and test facilities. This implies the need for long-term growth in research and development funding.<sup>26</sup>

In September 1991, Secretary Watkins followed a Secretary of Energy Advisory Board (SEAB) Task Force recommendation that the proposed BPX project not be funded because of growing cost estimates and anticipated budget constraints. This cancellation left the U.S. fusion program potentially bereft of any large-scale fusion experimental facility after the scheduled closure of the TFTR in FY 1994. Actual funding for the magnetic fusion program in FY 1992 was \$337.1 million and restored much of the funding loss in FY 1991, but funding demands to support TPX design and ITER activities resulted in a continued narrowing of the program

Once again, DOE turned to an advisory committee for assistance in setting priorities. In response to the request, the Fusion Energy Advisory Committee (FEAC) issued a series of reports<sup>27</sup> reviewing the physics and engineering/technology

requirements for meeting the 2025 goal for a Demonstration (DEMO) reactor under four alternative future budget scenarios and indicated their recommended priorities under each.<sup>28</sup>

FEAC strongly concluded that:

- Reaching the goal of an operating DEMO by 2025 is the approximate target date required if fusion is to be a significant contributor to U.S. energy supply by the middle of the 21st century.
- Fusion program budgets will have to increase at least 5 percent per year in real terms over the FY 1993 total of \$337.9 million with an *additional* increment for ITER construction to be plausibly consistent with the DEMO target date.
- Highest priority should be given to completion of D-T experiments in the TFTR and participation in ITER EDA under all budget scenarios.

Under its first or “reference” scenario, the panel called for an annual increase in the magnetic fusion program budget of 5 percent over inflation over the FY 1993 level of \$330.7 million, or an increase to about \$420 million in FY 1998 (in 1993 dollars). In addition to support for D-T experiments and participation in ITER, the panel recom-

<sup>26</sup> National Energy Strategy, *Powerful Ideas for America, First Edition 1991/1992* (Washington, DC: U.S. Government Printing Office, February 1991), pp. 130-131.

<sup>27</sup> FEAC, *September 1992*; Fusion Energy Advisory Committee, *Advice and Recommendations to the U.S. Department of Energy in Response to the Charge Letter of September 18, 1992*, DOE/ER-0594T (Washington, DC: U.S. Department of Energy, Office of Energy Research, June 1993), hereinafter referred to as *FEAC 1993*. Fusion Energy Advisory Committee, *Advice and Recommendations to the Department of Energy in Partial Response to the Charge Letter of September 24, 1991: Part D*, DOE/ER-0555T (Washington, DC: U.S. Department of Energy, Office of Energy Research, June 1992). FEAC was established to advise the Director of the Office of Energy Research/Assistant Secretary for Energy Research.

<sup>28</sup> Two scenarios requested in the charge to the committee were a constant dollar budget for magnetic fusion through FY 1996 and increasing the budget at 5 percent real growth per year through FY 1996. FEAC’s report included four scenarios:

- The “SEAB Task Force Scenario”—increasing the MFE budget in FY 1994 by 5 percent in real terms over the FY 1993 request (\$360 million) and annual growth at 5 percent per year in real terms thereafter;
- The FEAC “Reference Scenario”—increasing MFE funding at 5 percent in real terms above inflation starting from the appropriated FY 1993 level (\$339.7 million);
- The Constant or “Flat Budget Scenario”—allowing adjustments only for inflation for fiscal years 1993-96; and
- The “Declining Budget Scenario”—in which the MFE budget is frozen at the FY 1993 level in as spent dollars and declines at the rate of inflation (assumed at 3.1 percent per year).

See *FEAC, September 1992*, pp. 1-16.

mended construction of the TPX (steady-state advanced tokamak),<sup>29</sup> upgrades to the General Atomics DIII-D tokamak to support TPX and ITER, and restart of the ATF stellarator. The panel also recommended modest enhancements of the fusion materials program and of the fusion development and technology base programs to support ITER activities and student training in various areas of fusion engineering, and maintaining research in applied plasma physics at least at present levels. The panel did not include any allowance for expected increases in funds needed to complete ITER EDA activities over the levels originally agreed to among the four parties in 1992. TPX construction costs were then estimated at about \$500 million in FY 1989 dollars. Noting the persisting scientific uncertainties in extrapolation of the tokamak to a competitive commercial reactor despite its scientific successes to date, the committee suggested establishment and maintenance of a concept improvement program to investigate both tokamak and nontokamak confinement concepts as part of the U.S. fusion program as a matter of policy.<sup>30</sup>

The committee report contrasted the reference scenario with the budget levels recommended by a 1991 SEAB task force of a 5 percent annual increase above inflation over the FY 1993 budget request or an increase to \$360 million in FY 1993 rising to about \$460 million in FY 1998 (in 1993 dollars). SEAB had concluded that such an increase would be required to restore the program balance to a healthy base of activity. At a base of \$20 million over the reference scenario priorities, FEAC recommended studying a U.S. site for ITER, enhancing the U.S. ITER EDA support activities, and enhancing activities on improved

tokamaks and other concepts, fusion theory, computation, materials research, and technology development. The FEAC panel concluded that even this higher budget, while meeting recommended priorities, “would jeopardize U.S. ability to compete in hosting a site for ITER and require that base programs be held at levels lower than FEAC believes is appropriate given their importance.”<sup>31</sup>

Under a flat budget scenario approximately \$337.9 million per year in constant 1993 dollars) in FY 1993-FY 1998, adjusted for inflation, FEAC recommended proceeding with TPX on an extended construction schedule by prematurely terminating the Princeton Beta Experiment Modified (PBX-M) tokamak at the Princeton Plasma Physics Laboratory (PPPL) and delaying design of the 14 MeV neutron source.

Under the declining budget scenario, the annual program budget would remain at \$337 million in 1993 dollars unadjusted for inflation over five years. FEAC concluded that TPX could not be built, nor could design of the 14 MeV neutron source materials test facility begin until after FY 1997. Planned upgrades of existing facilities to support ITER would have to be stretched out. With shutdown of TFTR, the U.S. program would be faced with the loss of critical personnel and PPPL’s position as a world leader in experimental confinement physics research would be threatened. According to FEAC, the primary consequences of such a strategy would be to severely undermine the U.S. fusion program and its ability to participate effectively in ITER. It is unlikely under this scenario that the United States could participate in ITER construction and operation.<sup>32</sup>

<sup>29</sup> After cancellation of the BPX, a planning effort directed by the Princeton Plasma Physics Laboratory resulted in the proposal to build a smaller successor to the TFTR as a steady-state advanced tokamak machine with superconducting magnets and divertor designs that would be complementary to ITER. For more on the history and design of TPX, see ch. 3 of this report.

<sup>30</sup> FEAC, *September 1992*, p. 10.

<sup>31</sup> *Ibid.*, pp. 11-13.

<sup>32</sup> *Ibid.*, pp. 15-16.

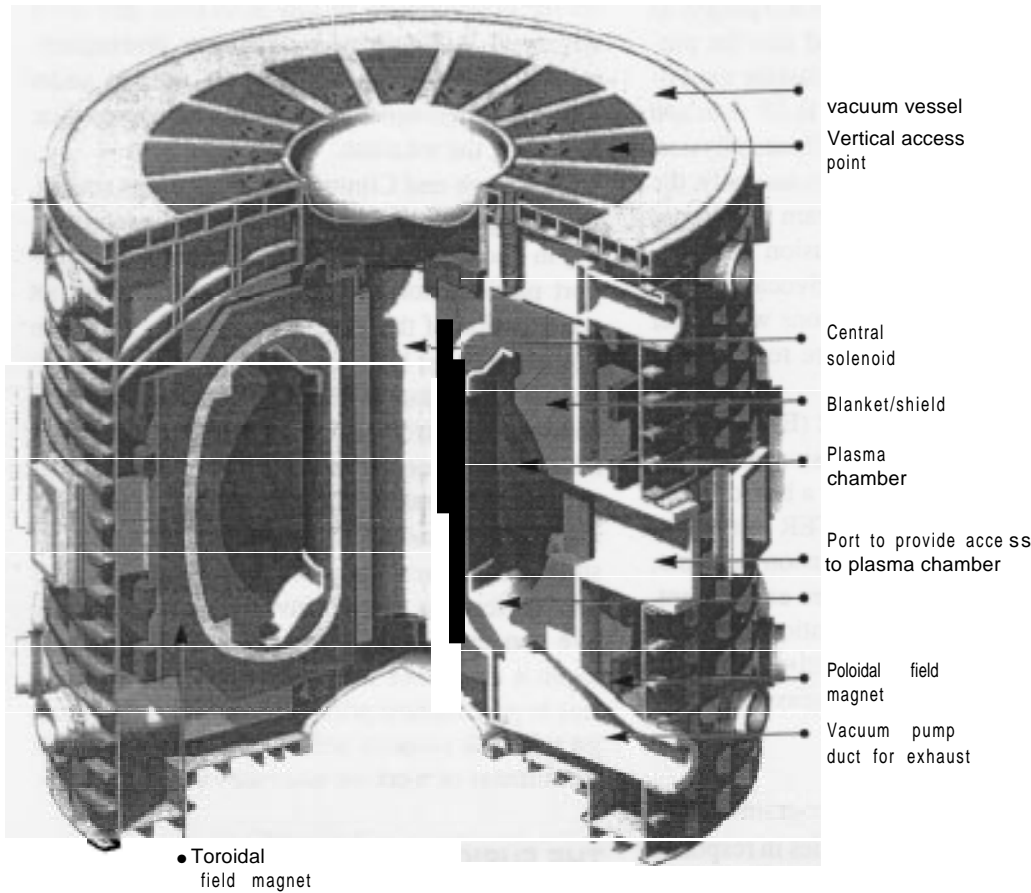

Scale: The ITER device will be about 30 meters high--or roughly as tall as a nine-story building.

Major components of the proposed ITER.

Another FEAC panel report made recommendations for IFE activities and indicated budget priorities, emphasizing research needs supporting heavy-ion drivers, and reiterated many of the conclusions of FPAC on the attractiveness of IFE.<sup>33</sup> In all cases the panel called for a balance among experimental and analytical program support for IFE, accelerator development, and beam physics. Three budget cases set by DOE were reviewed. According to the panel, the most significant development since the 1990 FPAC review was a re-

duction in the estimated cost for building ILSE to \$45 million because of technical advances, design changes, and availability of an existing site and facilities.<sup>34</sup> At an annual budget level of \$17 million (1992 dollars), the panel gave highest priority to ILSE construction and experiments along with supporting work on accelerator theory, reactor system studies, and technology development. At a middle funding level of \$10 million/year, the panel concluded that it would not be possible to com-

<sup>33</sup>FEAC 1993.

<sup>34</sup>Ibid., pp. 9-10. Estimate of \$45 million for ILSE costs is from U.S. Department of Energy comments on OTA draft report, November 1994.

plete the integrated ILSE demonstration project as proposed. The panel recommended that the program proceed with scaled up accelerator experiments in the low energy part of the ILSE plan and continue support in accelerator and beam physics. At a low funding level of \$5 million annually, the panel concluded that a U.S. program would not support a “credible” heavy-ion fusion development program and suggested that advocates of the heavy-ion program enter negotiations with other offices in DOE that might be more receptive to their work.

The Energy Policy Act of 1992 (EPACT), included a mandate for a five-year fusion energy research program. EPACT called for a broad-based program with participation in ITER activities, construction of a new major U.S. fusion machine, development of a heavy-ion driver experiment, and increased industrial participation. EPACT also imposed additional administrative and management requirements on DOE’s fusion program.

### ■ The Fusion Program Today

In the 1990s, the magnetic fusion program continues to evolve and redirect its activities in response to the suggestions of FPAC, FEAC, and congressional appropriations committees and the requirements of the fusion energy provisions of EPACT. The Office of Fusion Energy’s magnetic fusion activities have been narrowed to an even greater focus on tokamak concepts, national facilities, and greater reliance on international collaboration to move toward achievement of the next milestones in fusion energy development. The result is that work has been drastically curtailed on exploration of alternative confinement concepts that might have more attractive characteristics as a commercial energy source than tokamaks. Even more significantly to some in the fusion community, little progress can be expected at current funding levels

on the development of low activation and other advanced materials and on fusion powerplant-related technologies that will be needed under virtually all magnetic confinement approaches, including the tokamak.

The Bush and Clinton administrations sought, and Congress provided, increases in fusion funding in fiscal years 1993 to 1995 primarily to support participation in ITER, and design, but not construction of the TPX. The modest increase in funding has not been sufficient to offset the continued narrowing of the program as alternative concepts research and base program activities have been squeezed to keep major tokamak experiments operating. Despite EPACT’s endorsement of a broad-based fusion program and the strong recommendations of several outside advisory reviews to support investigation of alternative concepts, budget pressures, combined with explicit directions from appropriations committees to give highest priority to full funding of major tokamak projects and ITER, have resulted in curtailment of work on alternates to the tokamak.

### THE FUSION PROGRAM GOALS IN LAW AND POLICY

Fusion energy research is carried out under various grants of authority and congressional mandates. The most important sources of general authority for the fusion program are EPACT,<sup>35</sup> The Magnetic Fusion Energy Engineering Act of 1980,<sup>36</sup> and the Atomic Energy Commission Act of 1954.<sup>37</sup> These laws are summarized in box 2-A.

EPACT directs the Secretary of Energy to conduct a five-year fusion energy program to result in a technology demonstration by 2010 verifying fusion’s “practicability” for commercial power production. EPACT’s general goals for fusion energy research include:

---

<sup>35</sup> Public Law 102-486, section 2114, Oct. 24, 1992, 106 Stat. 3073-3074, 42 U.S.C. 13474.

<sup>36</sup> Public Law 96-386, Oct. 7, 1980, 94 Stat. 1539, 42 U.S.C. 9301.

<sup>37</sup> Act of Aug. 30, 1954, ch 1073, 60 Stat. 921, as amended, 42 U.S.C. 2011 et seq.

### BOX 2-A: Summary of Major Legislation on Fusion Energy Research

The **Energy Policy Act of 1992<sup>1</sup> (EPACT)** directs the Secretary of Energy to conduct a fusion energy program resulting in a technology demonstration by 2010 to verify fusion's "practicability" for commercial power production. EPACT set forth general goals for a broad-based fusion energy research effort and established several new management and reporting provisions including a requirement for a comprehensive fusion management plan and biannual reports. The Act also (under sections 3001 and 3002) applies general provisions relating to cooperative energy research and cost sharing to fusion research activities. To support this program, EPACT authorizes appropriations of \$339.7 million for fiscal year 1993 and \$380 million in fiscal year 1994.

Under EPACT, DOE's fusion energy research programs also are intended to support more general goals for federal energy supply R&D including: reducing oil import dependence, increasing the energy efficiency of the U.S. economy, stimulating economic growth, stabilizing and reducing greenhouse gas emissions, promoting environmental protection, developing more environmentally sustainable energy systems, enhancing technological competitiveness, fostering international cooperation and technology transfer, creating new market opportunities for American industry, and contributing to advancing fundamental scientific knowledge.

The **Magnetic Fusion Energy Engineering Act of 1980 (MFEEA)<sup>2</sup>** also sets forth policy goals and management requirements for the fusion energy program. The act called for an aggressive magnetic fusion R&D program with the goals of establishing engineering feasibility by 1990, and developing an operating magnetic fusion device by 1990 and an operating magnetic fusion demonstration plant for electric power production "by the turn of the 21st century." Section 4 directs the Secretary to maintain a "broadly based research program on alternative confinement concepts and on advanced fuels" in addition to "an aggressive plasma confinement research and construction program on the current lead concept,"<sup>3</sup> The program was to promote broad participation of industry and greater public understanding of fusion energy. The act also provided for continued cooperation in international fusion research and maintaining U.S. leadership in magnetic fusion.

The MFEEA requires the Secretary of Energy to prepare a comprehensive fusion program management plan, create a national fusion engineering center, establish a technical advisory panel on magnetic fusion to review the program and advisory committees for each fusion laboratory or facility, and report on program activities annually. The required management plans were issued in 1983 and revised in 1985 to reflect comments of a technical review panel and the changing energy research policy of the Reagan Administration. Triennial reviews were conducted in 1983, 1986, and 1990.

The MFEEA goals and program structure reflected the "energy crisis" mentality of the times and adopted the recommendations of the fusion technical review panel for a shift in the program from a focus on fundamental fusion science and plasma physics to technology development. The act called for substantial increases in annual appropriations for fusion research in later years to achieve these ambitious goals. These increases were not provided.

<sup>1</sup> Public Law 102-486, section 2114, Oct. 24, 1992, 106 Stat 3073-3074, 42 U S C 13474.

<sup>2</sup> Public Law 96-386, Oct. 7, 1980, 94 Stat. 1539, 42 U.S.C. 9301.

<sup>3</sup>42 U.S.C. 9303.

(continued)



### BOX 2-A (cont'd.): Summary of Major Legislation on Fusion Energy Research

DOE's fusion energy research activities are also conducted under the **Atomic Energy Commission Act of 1954**,<sup>4</sup> which provides basic authority for federal nuclear R&D activities and regulation. The act carried on many provisions of the prior act of August 1, 1946 under which fusion research was supported by the Atomic Energy Commission (AEC) and its successors. Most of the AEC's nuclear research responsibilities were transferred to the new Energy Research and Development Administration in 1974.<sup>5</sup> In 1977 these duties were vested in the newly formed Department of Energy.<sup>6</sup>

Among the purposes of that act are: to assist R&D to "encourage maximum scientific and industrial progress," to aid education and training, promote widespread participation in development of peaceful uses for atomic energy;<sup>7</sup> and to encourage international cooperation.<sup>8</sup> The federal government is authorized to support a broad range of research activities relating to nuclear processes, atomic energy theory and production, use of nuclear energy or materials for generation of usable energy, and for commercial and industrial applications.

The AEC was authorized to make grants and other contributions to the construction and operation of reactors and other facilities at educational and charitable institutions for education and training purposes,<sup>9</sup> and to conduct research activities and studies in its own facilities.<sup>10</sup> The AEC Act thus provides additional legislative authority for DOE support of fusion-related nuclear physics (including plasma physics) and the engineering education and training missions of the Office of Fusion Energy and Defense Programs.

<sup>4</sup> Act of Aug. 30, 1954, ch 1073, 60 Stat 921, as amended, 42 USC 2011 et seq.

<sup>5</sup> Public Law 93-438, Oct 11, 1974

<sup>6</sup> Department of Energy Organization Act, Public Law 95-91, Aug. 4, 1977.

<sup>7</sup> Atomic energy is defined as all forms of energy released in the course of nuclear fission or nuclear transformation. 42 U.S.C. 2014 Transformation is interpreted to include fusion.

<sup>8</sup> 42 U.S.C. 2013

<sup>9</sup> 42 U.S.C. 2051(c).

<sup>10</sup> 42 U.S.C. 2052

- support of a broad-based fusion energy program;
- participation in the ITER engineering design activities and related efforts;
- development of a technology for fusion power, and industrial participation in technology development;
- design and construction of a major new machine for fusion research and technology development;<sup>38</sup> and
- R&D on inertial confinement fusion energy, and development of a heavy-ion inertial confinement fusion experiment.

EPACT's reference to a broad-based fusion program echoes the language of MFEEA, which requires a "broadly based research program" on attractive alternate concepts and alternate fuels while also aggressively pursuing scientific progress via the tokamak path. The EPACT language is

<sup>38</sup>The major new machine has been interpreted by some as authorization for the proposed TPX, but others maintain that construction of the facility has yet to be authorized specifically.

cited by proponents of alternate fusion concepts as requiring DOE to support a more active and varied alternate concepts research program. Fusion program officials at DOE, however, interpret this directive as requiring them to support a broad range of research activities conducted by a variety of research institutions.

The comprehensive management plan for the fusion energy program required under EPACT is to include specific objectives, milestones, schedules, cost estimates, program management resource requirements, and an evaluation of the appropriate extent of participation by universities and the private sector in fusion activities. The plan must evaluate the requirements needed to build and test an inertial fusion energy reactor for purposes of power production. The plan also is to describe proposed U.S. participation in the design, construction, and operation of ITER and include an evaluation of international cooperative agreements on fusion research and of the need for strengthening existing agreements or negotiating new ones. The management plan was to have been completed within 180 days of passage of EPACT, i.e., by April 1993, however, DOE had not completed it as of December 30, 1994.<sup>39</sup>

EPACT also requires DOE to issue a report detailing fusion program organization staffing, funding, and expenditures, and describing the program's progress in achieving the specific objectives, milestones, and schedules in the fusion management plan as part of the energy technology inventory and status report for the management plan on energy research, development, demonstration, and commercialization under section 2304.<sup>40</sup> The first report was to have been sub-

mitted by October 1993. Updates on the progress of the fusion plan are to be included in subsequent reports every two years; by December 30, 1994, the first periodic progress report had yet to be delivered.

DOE has been slow to implement the new management and reporting requirements for the fusion program established by EPACT. Various reasons have been suggested for the lack of progress in issuing a comprehensive management plan for the future development of fusion power and for participation in ITER. The most important factors contributing to the delay appear to be the uncertainty over future budget levels for the fusion research program (under the current policy of level spending in discretionary programs) and a lack of key decisions about the priority to be accorded to fusion power among competing federal energy and science research programs, including decisions about ITER. These policy decisions are not made at the Office of Fusion Energy level and explain in part the absence of an updated management plan for fusion development. At the same time, there does not yet appear to be any public analysis of alternative long-term paths for federally sponsored fusion energy research efforts under constrained funding. Several developments may advance the opportunities for a reconsideration of fusion research policy. The Office of Fusion Energy recently reconstituted FEAC. Over the next year, the fusion research efforts are also likely to come under review by one or more panels convened by the Secretary of Energy. These include SEAB, the Task Force on Strategic Energy Research and Development, and the task force reviewing the work of the national laboratories.

<sup>39</sup> DOE has released two reports relevant to some of the planning material requested. On November 21, 1994, Secretary Hazel O' Leary transmitted to several congressional committees the "Interim Report to the Congress on Planning for International Thermonuclear Experimental Reactor Siting and Construction Decisions," in partial response to requests for a detailed ITER siting and development plan in the FY 1993 and FY 1994 Energy and Water Development Appropriations conference reports. The Secretary advised the committees that a more complete response could not be provided until the ITER Interim Design Report is completed and accepted by the parties. In August 1994, the Department of Energy released for comment a draft of "A Management Plan for the Conduct of Research, Development, Demonstration, and Commercial Application of Energy Technologies" required under section 2304 of EPACT. The appendix to the draft contains a very brief one-page figure on fusion technology issues, performance goals, benefits/leverage, and technology readiness dates.

<sup>40</sup> 42 U.S.C. 13523(c).

## LEGISLATIVE DIRECTIVES

Priorities for the fusion energy programs are shaped by directives contained in appropriations acts and reports and pending legislation. In some instances, DOE has given greater weight to the directions of appropriations committees than to the recommendations of its technical reviewers and to more general provisions of law. For example, the FY 1994 Energy and Water Appropriations Conference Report directed DOE to:<sup>41</sup>

- focus the DOE magnetic fusion program on elements that further the design, construction, and operation of ITER and a future demonstration fusion reactor;
- set priorities for the domestic fusion energy program identifying elements that contribute directly to development of ITER or DEMO;
- provide a plan describing: 1) a selection process for a U.S. host site for ITER; and 2) the necessary steps by the international partners for selecting a final ITER host site and for the design, construction, and operation of ITER by 2005, including relevant milestones and budget estimates;
- begin evaluation and selection of a U.S. ITER host site;
- give highest priority in the national program in FY 1994 to D-T experiments in the TFTR at PPPL; and
- proceed with design and R&D tasks on TPX, upgrades of the DIII-D tokamak, and an aggressive program on low activation materials to be tested in ITER and used in DEMO, and provide a \$500,000 increase in funding for the IFE program.

Effectively, the appropriations conference report applied many of the provisions of S. 646, a bill passed by the Senate in June 1993, that would have focused the magnetic fusion program almost exclusively on activities in support of ITER and

TPX tokamak approaches and eliminated investigation of nontoroidal concepts. This approach was highly criticized by many in the fusion research community.

In contrast to the appropriations directives and S. 646, the House passed H.R. 4908, the Hydrogen, Fusion, and High Energy and Nuclear Physics Research Act of 1994 in August 1994. H.R. 4908 would have supported ongoing TPX and ITER activities. It also would have restored research activities on alternative fusion confinement concepts through establishment of a separate program that would have responsibility for advancing heavy-ion inertial fusion energy and other alternate concepts. It is expected that similar legislation will be introduced in the 104th Congress.

Attempts to cut the fusion energy program budget to produce savings for deficit reduction and support of competing renewable and energy efficiency technologies also were before the House of Representatives in the 103d Congress. In November 1993, the proposed Penny-Kasich amendment to H.R. 3400, the Government Reform and Savings Act of 1993, included a provision rescinding \$70 million from the fusion energy program.<sup>42</sup> During consideration of the FY 1995 Energy and Water Appropriations Act in the House, an amendment to strike the \$67-million funding for TPX construction was defeated.<sup>43</sup>

## FEDERAL FUSION ENERGY RESEARCH PROGRAMS

DOE supports a variety of R&D activities related to fusion energy in its science and defense programs. Primary responsibility for fusion energy science and technology development rests with the Office of Fusion Energy (OFE) in the Office of Energy Research. OFE oversees most of the civilian research efforts involving plasma physics, confinement concepts, reactor studies, and related

<sup>41</sup> Conference Report on H.R. 2445, H. Rept 103-292, 103d Cong., 1st sess., at 139 *Congressional Record* H7948, Oct. 14, 1993 (daily ed.)

<sup>42</sup> See 139 *Congressional Record* H10479, Nov. 20, 1993 (daily ed.).

<sup>43</sup> See 140 *Congressional Record* H4431-4439, June 14, 1994 (daily ed.).

technology development. The Office of Defense Programs sponsors research on ICF science and technology for potential applications in meeting its nuclear weapons and stockpile stewardship responsibilities as well as for long-term energy potential. OFE also supports R&D on the energy applications of fusion technologies developed under the separate weapons-related inertial confinement fusion program.

Fusion research activities are carried out at national laboratories, universities, and private companies. Figure 2-4 shows the distribution of major fusion research facilities funded by OFE. In FY 1994, DOE's magnetic fusion program was budgeted at about \$347.6 million with much of that funding going to support fusion activities at PPPL, Oak Ridge, Lawrence Berkeley, and Lawrence Livermore National Laboratories, and at General Atomics in San Diego and various universities. The Defense Program's ICF program was funded at \$169.2 million in FY 1994 with activities concentrated at Livermore, Sandia, and Los Alamos National Laboratories, the Naval Research Laboratory, and the Laboratory for Laser Energetics at the University of Rochester.

## ■ Program Goals

Goals for the DOE fusion energy program are set by legislation and/or presidential or secretarial decisions, and the program offices have little leeway to change them. Thus, fusion program goals have remained relatively constant in objectives and schedules and untempered by budget constraints that could hamper their timely achievement. The FY 1995 DOE budget request for the magnetic fusion energy program states that "the overarching goal of the program is to demonstrate that fusion energy is a technically and economically viable energy source." More specifically, according to DOE, the major long-term goals of the magnetic fusion energy program are to establish the "practi-

cability of electric power production by 2010" (as called for in EPACT); to show the engineering and economic feasibility of fusion power production by having an operating demonstration reactor by (around) 2025, to be followed by an operating commercial prototype reactor by (around) 2040 (as set out in the 1990 NES and FPAC recommendations). Other goals for the program include the education and training of fusion scientists and engineers, and encouragement of international collaboration. DOE's FY 1995 budget request admits that "budgetary constraints over the past few years may mean that the schedule for meeting such objectives is delayed."<sup>44</sup>

DOE has developed more detailed goals and strategies that it has relied on in setting priorities for its magnetic and inertial fusion energy research and technology development programs

### **Magnetic Fusion**

For the magnetic fusion program, among the most important scientific and technical issues that must be addressed to achieve the program's goals are ignition physics, fusion nuclear technology, magnetic confinement optimization, and development of low activation materials.<sup>45</sup> The budget request outlines the four major elements of DOE's magnetic fusion activities directed at resolving these issues.

1. *Study of D-T-fueled reactions in the TFTR.* Beginning in FY 1994, D-T fuel was introduced into the TFTR to allow experiments to increase the amount of energy obtained from fusion reactions and to verify of extrapolations made from nontritium reactions such as D-D or a mix of deuterium and helium<sup>3</sup> (D-He<sup>3</sup>). The goal of the TFTR experiments is the production of 10-million watts of power for one second. (This will move laboratory production of fusion power approximately 30 percent of the way toward achievement of the goal of breakeven). TFTR's D-T experi-

<sup>44</sup> U.S. Department of Energy, Office of the Chief Financial Officer, "FY 1995 Congressional Budget Request: vol. 2, Energy Supply Research and Development," DOE/CR-0021, 1994, p. 425.

<sup>45</sup> *Ibid.*, p. 426.

### 38 IThe Fusion Energy Program: The Role of TPX and Alternate Concepts

FIGURE 2-4: Major Fusion Research Centers Funded by the Office of Fusion Energy, FY 1994

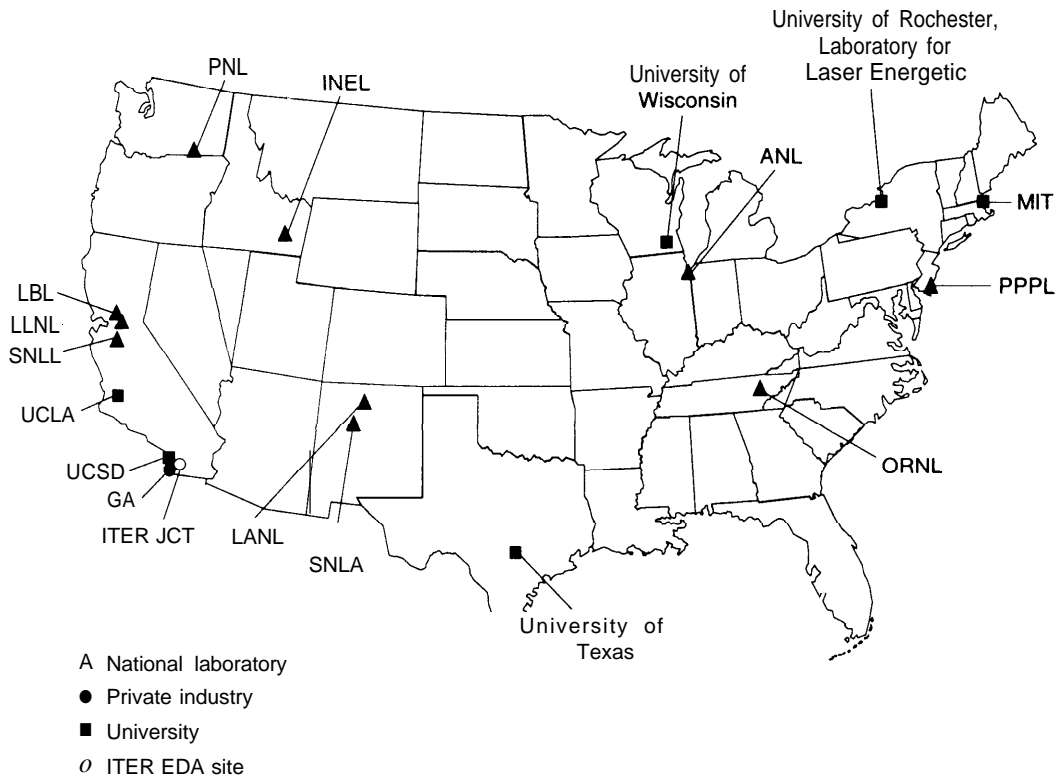

**KEY**

- ANL= Argonne National Laboratory
  - GA= General Atomics
  - INEL= Idaho National Engineering Laboratory
  - ITER JCT= ITER Joint Central Team
  - LANL= Los Alamos National Laboratory
  - LBL= Lawrence Berkeley Laboratory
  - LLNL=Lawrence Livermore National Laboratory
  - MIT=Massachusetts Institute of Technology
  - ORNL=Oak Ridge National Laboratory
  - PNL=Pacific Northwest Laboratory
  - PPPL= Princeton Plasma Physics Laboratory
  - SNLA=Sandia National Laboratory-Albuquerque
  - SNLL=Sandia National Laboratory-Livermore
  - UCLA= University of California, Los Angeles
  - UCSD=University of California, San Diego
- SOURCE: U.S. Department of Energy, 1994

ments will be the first to generate important data and experience on plasmas with internally generated heat from alpha particles. Attainment of alpha particle heating will be critical for self-sustained fusion reactions in future development steps such as ITER and for eventual fusion powerplants.

**2. Participation in the ITER international collaboration.** ITER is intended to demonstrate the scientific and technical feasibility of fusion by producing over 1,000 MW of fusion power under ignition conditions and serving as a test bed for fusion technology in support of a demonstration powerplant--e.g., remote handling, divertor, fuel injection, heat transfer, maintenance, materials, and blankets.

**3. Development, construction, and operation of a new domestic advanced tokamak device.** The Tokamak Physics Experiment to be sited in the TFTR test cell at PPPL will be the first major new U.S. fusion facility in over a decade, if it is constructed. The proposed TPX will provide the opportunity to study long-pulsed advanced tokamak operations and is designed to take advantage of the TFTR site and much of its existing equipment. TPX is intended to significantly improve the physics results of tokamak reactors by exploring advanced operating modes with the potential for better confinement conditions, higher pressure limits, and efficient steady-state current drive. TPX would be built using superconducting magnets and thus would contribute to U.S. industry experience with key components also needed for the ITER project. TPX also would provide critical operating experience in the steady-state/long-pulse mode that will be the focus of a later ITER nuclear testing phase.

**4. Maintenance of a base program of fundamental physics and technology research.** OFE will continue to maintain a range of base program activities required to support development of ITER, TPX, and DEMO, and operation of existing major U.S. tokamaks, DIII-D and Alcator-C-Mod. The base program funds research on fu-

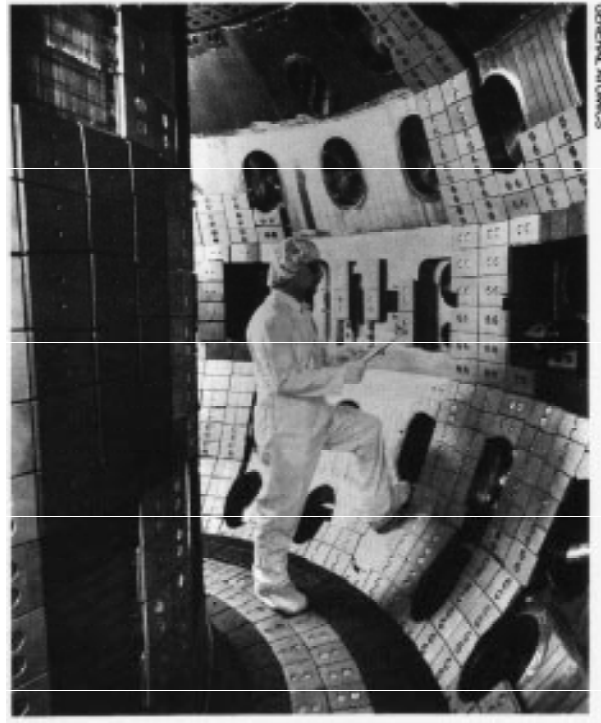

Inside the vacuum vessel of the DIII-D tokamak.

sion theory and modeling, fusion computing systems, and development of low activation materials.

These elements are spread over several subprograms and support what is now characterized as the mainline magnetic fusion energy development program shown in figure 2-5. This long-term strategy was developed in consultation with the fusion community, generally reflecting priorities established in the fusion program in the mid-1980s as modified to take into account changing budget conditions and the recommendations of FPAC and FEAC.

Under this magnetic fusion development strategy, research will progress through a number of critical steps and new facilities to result in eventual demonstration of commercial power production by the middle of the 21st century. The pathway reflects a heavy reliance on the success of the tokamak confinement approach as the most likely (and only available) technology to meet key development milestones for fusion power.

FIGURE 2-5: Magnetic Fusion Program Development Plan, 1994

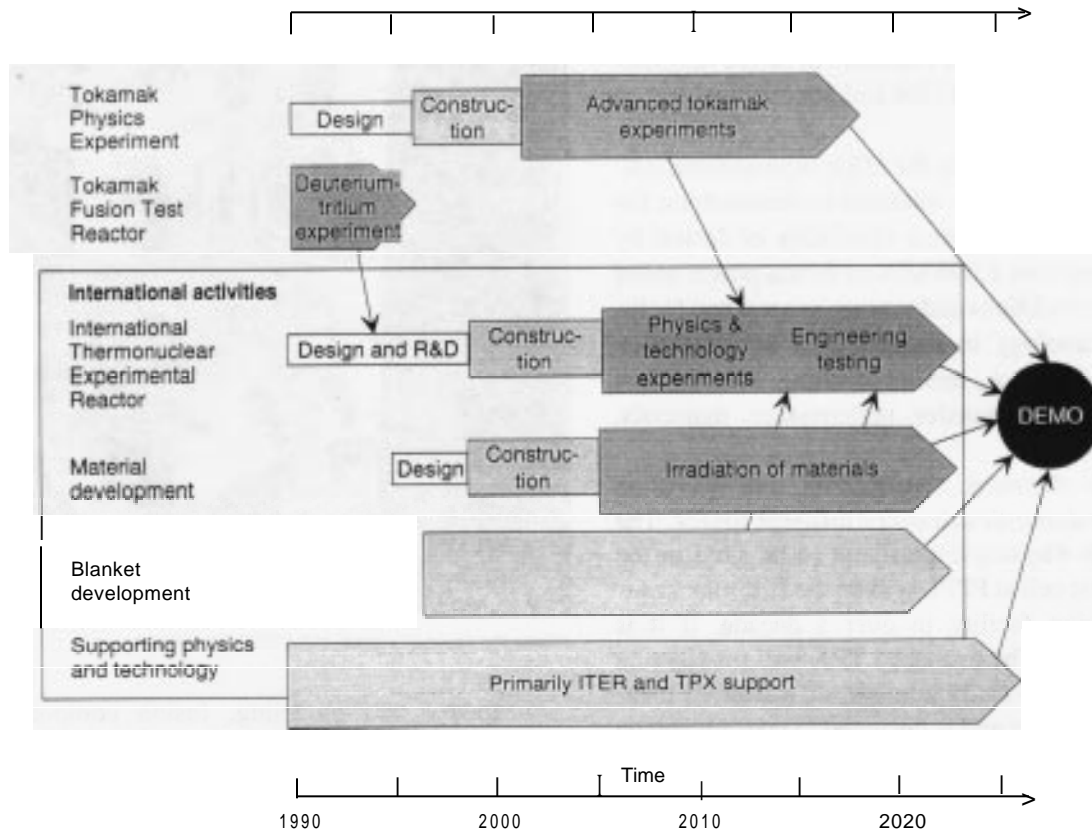

SOURCE: U.S. Department of Energy, 1994.

Key elements shown are:

- D-T experiments and alpha heating in the **m** ,
- demonstration of ignition, long-pulse, and technology testing in ITER,
- achievement of steady-state/advanced tokamak reactor conditions in TPX,
- development of low activation materials for fusion reactors in a 14 MeV materials test facility,
- possible development of a blanket test facility, and
- maintaining balance in the rest of program.

### ***Inertial Fusion Energy***

Major goals for the civilian energy aspects of the inertial confinement fusion energy program are development of components for fusion energy systems and reactor systems that can take advantage of the target physics developed by the Defense Programs' ICF research. Activities include continuing support for the investigation and development of a high-efficiency, high-repetition driver, targets, and reactor concepts that are particularly important to energy applications of ICF, but not of concern in weapons stewardship/research. The current IFE program emphasizes support for

FIGURE 2-6: Inertial Confinement Fusion Program Development Plan, 1994

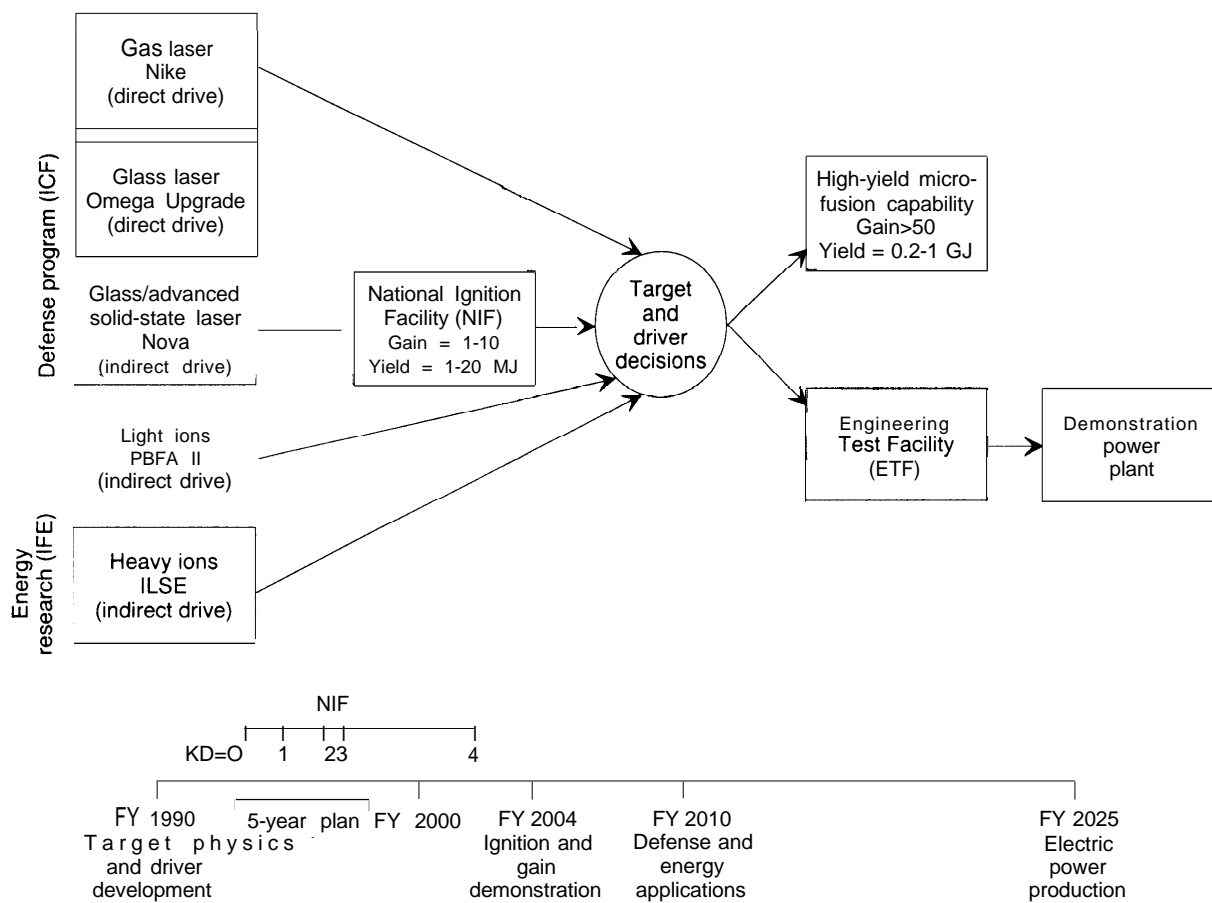

KEY  
KD=Key Decision

SOURCE U S Department of Energy.

development of the heavy-ion accelerator driver approach, and development of IFE target designs with features of high gain and ease of production. The IFE program plan relies heavily on progress in the ICF program, such as the proposed National Ignition Facility (NIF), to achieve key IFE milestones and experience to allow a decision to proceed with an IFE engineering test facility.

Cutbacks in alternate concepts research in the MFE program have left inertial confinement as the only alternative fusion technology sufficiently advanced to compete with the tokamak concept

when the key decision for choice of a demonstration fusion reactor concept is made. The long-term development path for demonstration of commercial power production using inertial confinement fusion technologies is shown in figure 2-6. Critical technology development for IFE along this path includes: achievement of ignition in the proposed NIF, development of an efficient repetitive driver, improvements in target design and manufacture, and development of a fusion energy target chamber and energy extraction technology for use in a IFE engineering test facility.



This strategy parallels the path and key decision points for magnetic confinement fusion in the competition between MFE and IFE that was adopted as the future fusion strategy in 1990. A proposed change in the ICF plan could permit an alternative development path with fewer major facilities by integrating the IFE engineering test facility and the laboratory microfusion facilities using separate target chambers but a common driver.<sup>46</sup> It should be noted, however, that many questions concerning the detailed cost estimates and choice of technologies for an IFE development path remain to be resolved.<sup>47</sup>

### ■ OFE Program Structure

The Office of Fusion Energy under the Assistant Secretary for Energy Research has three operating divisions—Confinement Systems, Applied Plasma Physics and Technology, and ITER and Technology—roughly corresponding to its budgetary subprograms: Confinement Systems, Applied Plasma Physics, and Technology and Development.<sup>48</sup> The discussion here is organized according to the budgetary subprograms used in appropriations requests.

The **Confinement Systems Subprogram** supports the planning, design, and operation of existing and new reactors and facilities to improve the tokamak concept through research to achieve a more detailed understanding of fusion plasmas in reactor-like conditions. The goal of this research is to develop technically and economically credible fusion power reactors for commercial energy production in the 21st century. Major areas of research include: energy confinement, plasma heating, fuel injection, power handling and particle

control, current drive, and alpha particle heating and its impacts on confinement and stability. The division also conducts physics R&D on existing machines for ITER EDA activities. The FY 1995 budget request reports that budget- and policy-driven program redirection in the past decade have reduced the number of operating fusion facilities supported by the programs as activities are increasingly concentrated on ITER, TPX, and high-priority issues. The division has tried to offset some of the impacts of this redirection by encouraging the scientific staff of the affected laboratory and university programs to collaborate at facilities with operating fusion devices, including international collaborations in Germany, France, England, and Japan. Total funding for the confinement systems subprogram in FY 1994 was \$168 million with 45 percent going to operation of the TFTR, 40 percent to operation of base toroidal facilities (e.g., DIII-D and Alcator C-Mod), 11 percent to TPX design activities, and 4 percent for advanced toroidal facilities (i.e., the ATF stellarator). More than half of the subprogram's budget is dedicated to programs at the Princeton Plasma Physics Laboratory. The subprogram's FY 1995 budget request was \$150.5 million.

The **Applied Plasma Physics and Technology Subprogram** supports research to improve understanding of fusion principles and to investigate innovative techniques leading to improved plasma confinement conditions. Responsibility for this budget subprogram rests with the Applied Plasma Physics and Technology Division. This division oversees work on experimental plasma research, fusion theory and computing, theoretical and experimental physics, and analysis and de-

<sup>46</sup> Alex Friedman, Lawrence Livermore National Laboratory, personal communication, Aug. 11, 1994; and C. Olson et al. "ICF Diverse Strategies for IFE," paper presented at the International Atomic Energy Agency Technical Committee Meeting, Paris, Nov. 14-18, 1994.

<sup>47</sup> Some researchers have proposed an alternative path to the mainline ITER-DEMO tokamak-based development path for magnetic fusion. See, e.g., Stephen O. Dean, "Fusion Power Development Pathways," *Journal of Fusion Energy*, vol. 12, 1994, pp. 415-420; and Stephen O. Dean et al., "An Accelerated Fusion Power Development Plan," *Journal of Fusion Energy*, vol. 10, 1991, pp. 197-206.

<sup>48</sup> The operating divisions were reorganized in 1992 to reflect the growing concentration on ITER and to aggregate longer term issues in an Advanced Physics and Technology Division covering materials, systems studies, alternative fusion concepts (including IFE), exploratory toroidal improvements, and theory. The budgetary subprograms remained unchanged, however.

sign supporting major devices. The program also is responsible for developing diagnostics, plasma heating and control concepts, and data necessary to design and run major experiments. A major initiative of this subprogram in recent years has been support of development of computer codes and capabilities for simulating plasma confinement conditions on high-performance computers and establishment of improved computer networks linking major energy research centers and fusion facilities in the United States and overseas. With 1990s program redirection, primary emphasis is given to research activities in support of ITER and TPX design.

This division also administers OFE's modest program to support innovative nontoroidal confinement methods research as recommended by FPAC and FEAC. Through a process of solicitation of proposals, several researchers are given grants on a three-year basis for small-scale, proof of concept experiments for innovative tokamak improvement concepts and unconventional toroidal concepts. A total of \$1.2 million per year was allocated to this initiative. Not included in this program are the funds used for work in alternative toroidal concepts, such as the reversed field pinch, and on physics issues that are complementary to and supportive of work on the tokamak confinement concept.

Funding for plasma physics activities in FY 1994 was \$59 million with about 31 percent going to plasma theory, 44 percent to support experimental research, and 25 percent to MFE computing. Lawrence Livermore National Laboratory, which operates a major fusion computer center, received about 17 percent of total funding under this program in FY 1994. The FY 1995 request was \$54.3 million.

The **Technology and Development Subprogram** supports work on the design and technology development for ITER; the development of technologies needed for TPX, DIII-D, and other fusion experiments; and studies of future fusion systems. (Subprogram responsibilities are mainly carried out under the ITER and Technology Division.) Projects are organized in three technical

areas: ITER, plasma technologies, and fusion technologies.

The ITER technical area includes funds for the U.S. share of ITER design and development work, except for the advanced materials, theory, and diagnostics research activities funded under the applied plasma physics and confinement systems subprograms. Funds are used to pay for ITER technology development tasks negotiated with the ITER Director and approved by the ITER Council. Total operating funds for ITER activities under this program were \$62.4 million in FY 1994 with an increase to \$68.6 million requested for FY 1995.

The plasma technologies activities include developing technologies for forming, confining, heating, and sustaining a reacting fusion plasma such as magnet systems, heating systems, fueling systems, and materials in the plasma environment. A major focus of these efforts has been directed at development of reliable high-field pulsed and steady-state superconducting magnet systems for ITER and TPX. These efforts were funded at \$5.8 million in FY 1994, with a request for \$5.3 million for FY 1995.

The fusion technologies activity supports research that is important for TPX, ITER, and future power reactors, including materials development and long-term waste issues, safety and environmental considerations, component reliability, tritium fuel breeding and processing, and power extraction. This area also has supported scoping studies for a high-energy neutron irradiation test facility, which is critical to the development of low activation materials for future devices, and cooperative work under ITER, the International Atomic Energy Agency (IAEA), and U.S.-Japan bilateral agreements on blanket engineering, and Tritium Systems Test Assembly. Fusion system studies activities support analytical, engineering, and computational studies of fusion systems to identify potential problem areas and to provide future program direction. The FY 1994 funding for various fusion technologies activities was about \$12 million. The FY 1995 request of about \$15

## 44 | The Fusion Energy Program: The Role of TPX and Alternate Concepts

million accommodates an increase in funding for advanced materials activities.

Total funding for the Development and Technology Subprogram in FY 1994 was about \$80 million. Major funding recipients included Argonne, Lawrence Livermore, Los Alamos, Sandia, Pacific Northwest, and Oak Ridge National Laboratories. DOE has requested \$89 million for this subprogram in FY 1995.

### ■ The Defense ICF and IFE Programs

The ICF program is part of DOE's nuclear weapons research and technology development activities under the Office of Defense Programs. ICF is supported because of the ability to produce pure thermonuclear burn in a laboratory environment to study weapons physics and effects as an alternative to underground testing and to provide the research base for longer term fusion energy applications. The primary emphasis of the program is on demonstrating ignition in a laboratory microfusion device and developing both direct and indirect driver technologies. Related work focused solely on energy aspects of ICF is supported under the Office of Fusion Energy Applied Plasma Physics and Technology Division. Following significant accomplishments in target physics in the late 1980s that supported the scientific feasibility of ICF, the ICF program began to focus on appropriate drivers primarily intended for defense and ICF physics purposes and to proceed with the design of the proposed NIF. In December 1993, Energy Secretary Hazel O'Leary declassified portions of the Defense Programs relevant to IFE. Thus, results from the experiments with ignition of ICF plasmas may be used for energy applications.

Research on systems to explore the development of IFE as a potential civilian energy source is carried out as a separate subprogram of OFE. The primary technology activity has been support for

the development of a heavy-ion driver and study of inertial fusion energy targets. IFE subprogram activities are closely coordinated with the Defense ICF Programs. In fact, work on inertial fusion energy in OFE is often closely tied to projects supported by the Defense ICF Program. Work on ICF physics, and target design benefits energy applications. Researchers from both programs maintain close professional contact.

The Defense ICF Program was funded at \$169 million in FY 1994 and at \$176 million in FY 1995. Inertial fusion energy programs received \$4 million in FY 1994—half the level of the program's fiscal year 1993 budget—reflecting a decision by DOE to defer consideration of construction of the accelerator for the Induction Linac Systems Experiment.

### ■ Fusion Program Budgets

The FY 1995 DOE budget request sought \$372.6 million for the Magnetic Fusion Energy Program. The request supported U.S. direct and indirect activities for ITER, TPX design and construction startup activities, and continuing analysis of data from the TFTR D-T experiments following shutdown in FY 1994 to allow the test cell to be prepared for TPX construction. The request also called for hardware upgrades to DIII-D to support its capabilities to address key issues in design and operation of ITER and next generation machines. In addition, funding was sought for the base physics program, including support of ITER, and tokamak improvements, along with modest increases in funds to support materials development for future fusion devices (including preliminary work on design of a neutron source facility as an international collaboration through IAEA coordination, much like early phases of ITER project development).

Congress appropriated the full requested \$372.6 million for the Office of Fusion Energy activities.<sup>49</sup> However, the conferees declined to ap-

---

<sup>49</sup> Conference Report on H.R. 4506, The FY 1994 Energy and Water Appropriations Act, H. Rpt. 103-533, S. Rpt. 103-291, 103d Cong., 2d sess., Aug. 3, 1994, published in 140 *Congressional Record* H6888, Aug. 4, 1994 (daily ed.) Subsequent general reductions in the DOE budget have left \$364.563 million for fusion program expenditures in FY 1994.

prove construction spending for TPX, but did allow DOE to continue with TPX engineering design and R&D (\$42 million) and to purchase long-lead-time superconducting materials (up to \$2 million). The conferees directed DOE to use standard phased industrial contracts for TPX design activities to provide for future construction approval, when and if authorized by Congress.

The conferees also provided \$65 million for continuation of additional D-T experiments in the TFTR until such time as TPX construction is approved and TFTR activities are wound down. Without these additional funds, TFTR was scheduled to be shutdown at the end of FY 1994 to make funds available for TPX activities. Senate and House members called for legislation explicitly authorizing TPX construction. An additional \$8 million was provided for operation of the PBX-M tokamak facility at PPPL and \$8.7 million was provided for IFE energy development activities to allow progress on the ILSE heavy-ion driver. Additionally, the conference report calls on the President's Council of Advisors on Science and Technology (PCAST) to review the magnetic fusion energy and inertial confinement fusion energy development programs and to report to Congress on their future direction given the large sums required for program expansion.<sup>50</sup> PCAST is expected to begin their review of the fusion program early in 1995 and to complete their recommendations by June 1995, according to DOE.<sup>51</sup>

The FY 1995 budget provides adequately for ITER activities and in that respect is in agreement with FEAC, FPAC, congressional recommendations, and the DOE request. Delays in construction of TPX are not consistent with the schedules recommended by the advisory panels and will eventually add to its cost. (Preliminary estimates of the cost of the one-year delay have not yet been

made public.) The budget increases restore some funding for development of ILSE in the IFE program but are still less than reviewers recommendations.<sup>52</sup> TPX and ITER supporting research and development activities continue to absorb most of the rest of the fusion program budget given the directives of the FY 1993 conference report (see figure 2-7).

Overall the FY 1995 budget is approximately at the levels and priorities analyzed by FEAC for magnetic fusion, but is less than the funding level suggested for IFE. Appropriations levels and intra-program allocations have continued to fall far short of the recommendations of FPAC for both programs. It is probably too early to determine what effect, if any, the project delays and decreased funding of basic program components may have on attainment of the ultimate goal of developing a technically viable demonstration fusion reactor by 2025.

To the extent that ITER and TPX become the exclusive driving focus of the magnetic fusion program, FEAC and FPAC hopes that recommended budget increases would restore balance to the program in support of basic physics, alternative concepts, and materials and technology development have not been met.

ITER and TPX-related budget demands will continue to create budget pressures on other program elements. TFTR decommissioning expenses will absorb much of the roll off from shutting down TFTR operation for several years. Over the next few years, DOE and the program will need to obtain additional increments required for TPX construction and operation, ITER final design and siting activities, ITER construction, and development of heavy-ion drivers. FPAC estimated that these increments could increase the to-

<sup>50</sup> Conference Report on H.R. 4506, at 140 *Congressional Record* H6942, Aug. 4, 1994 (daily ed.)

<sup>51</sup> "Curtis Warns New Congress, Tight Budget Will Harm Fusion Program," *Inside Energy with Federal Lands*, Dec. 5, 1994, p. 11.

<sup>52</sup> The status of ILSE is still uncertain. The Office of Energy Research has suggested that Lawrence Berkeley Laboratory scale back the ILSE project and proceed with construction of the first third of the proposed project on a stretched out schedule and call it "ELISE." Roger Bangerter, Lawrence Berkeley Laboratory, personal communication, Nov. 17, 1994.

**FIGURE 2-7: U.S. Department of Energy Magnetic Fusion Program Budget, FY 1995, by Activity**

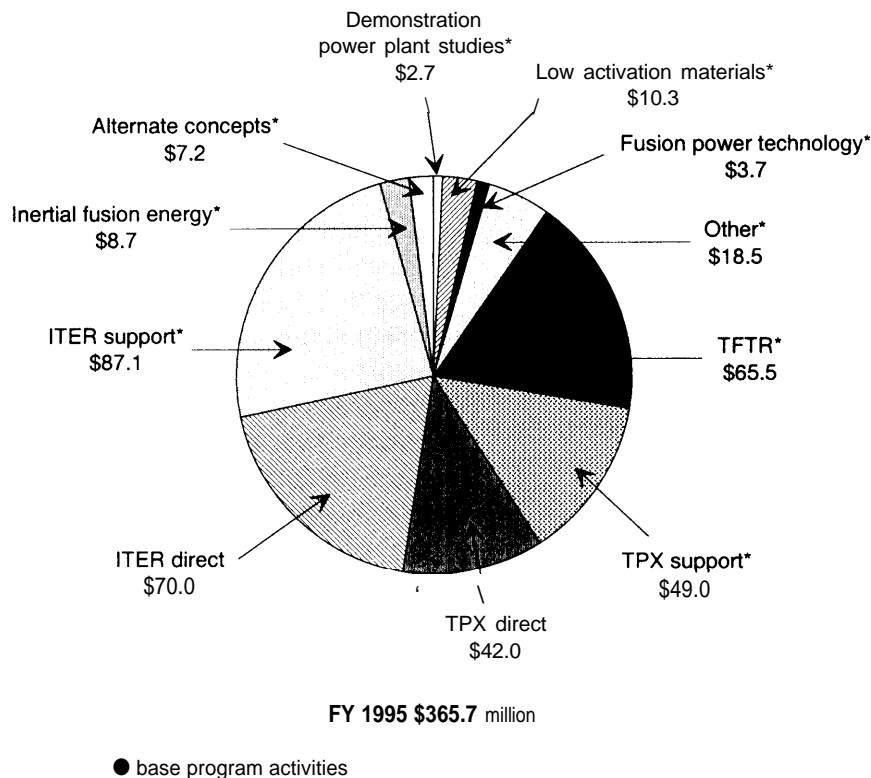

NOTE: Total funding for fusion activities reflects the Office of Fusion Energy share of the general reduction in DOE spending of \$8 million from the FY 1995 appropriation of \$3726 million. Activity categories reflect DOE program managers' assessments of how fusion funds are allocated among R&D activities and are not identical with budget categories used in appropriations requests

SOURCE: Office of Technology Assessment, 1995, based on information from the U.S. Department of Energy

tal fusion program budget to \$1 billion per year by the late 1990s and that annual budgets of at least this amount will be needed to support activities needed to enable informed decisions on selection and design of a demonstration reactor to be operational by about 2025.

### FUTURE BUDGET CHOICES

To meet the magnetic fusion program's fusion energy development path laid out in prior program

plans calling for maintenance of a base program, construction of TPX and participation in ITER EDA activities, funding would have to rise from the current level of \$372 million in FY 1995 to almost \$550 million in FY 1998. A decision to proceed with ITER construction could require annual increments above 1998 levels rising from about \$50 million in FY 1999 to about \$400 million in FY 2001<sup>53</sup> and higher as construction activity increases (see figure 2-8). This estimate assumes

<sup>53</sup> Estimates are from figures prepared by DOE for remarks of N. Anne Davies, Director, Office of Fusion Energy, presented to the Fusion Energy Advisory Committee, Dec. 1, 1994. The estimates are based on internal planning documents of OFE and are not reflected in DOE out-year budget estimates included in the President's FY 1995 budget request to Congress.

FIGURE 2-8: Estimated Funding Levels for Magnetic Fusion Energy Program for TPX, ITER and 2025 DEMO, FY 1990-2001 (\$ in millions as spent)

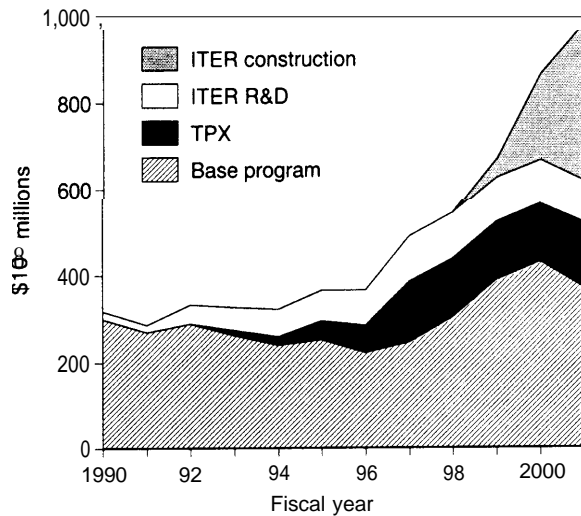

NOTE: This figure is based on internal Off Ice of Fusion Energy planning estimates and the funding levels shown are not reflected in FY 1995 budget request documentation. The increase in base program funding in FY 1997-2001 reflects increased activity in support of TPX and ITER and for a proposed fusion materials test facility.

SOURCE: Office of Technology Assessment, 1995, based on information from the U.S. Department of Energy.

that ITER is not located in the United States, thus avoiding a possible host country premium.<sup>54</sup> However, present budget plans calling for flat budgets for discretionary programs would seem to rule out any real increase in the fusion program budget without a substantial justification for it and a corresponding reduction in another program.

The fusion program would seem to have several options under a five-year flat-budget horizon. It

could try to meet direct funding needs for EDA activities and a stretched out construction schedule for TPX by cutting more deeply into base programs. How viable such an approach would prove is questionable, since a significant portion of the base program activities underwrite research programs that lend indirect support to ITER and TPX projects or are complementary to them. Cutting into the base program would make it even harder to fund initiatives to expand consideration of alternative nontokamak confinement concepts, including inertial fusion energy and the development of advanced materials and reactor technologies necessary for progress toward DEMO. Such a funding scenario might also call into question the rationale for proceeding with a major new domestic tokamak and ITER while substantially weakening the domestic base program and the research and industrial infrastructure that is intended to benefit from these activities.

As difficult as the problems for the fusion program seem under a future flat-budget scenario, proposals to cut energy research spending dramatically, including fusion, may trigger further debate about the appropriate role and direction for the fusion program under lower budgets. Some members of the fusion research community question whether a low budget path would be warranted at all, except perhaps to document the state of fusion research for future generations or perhaps to allow U.S. researchers to participate at some level in the fusion research programs in Japan, Europe, and Russia—assuming of course that those nations elect to continue their efforts in the absence of an active United States program. Others are not nearly so pessimistic, although they too would express disappointment if the U.S. were not to participate directly in the next “big step” fusion project. Among this latter group, some see the possibility

<sup>54</sup>In discussions investigating issues related to ITER siting, representatives of the parties and observers have suggested that the host country for ITER could be requested to pay an additional “premium” or contribution to ITER costs in recognition of the economic benefits that might flow to the local economy from hosting such a large construction project and research facility. A precedent for such a premium is the arrangement that led to the Joint European Torus (JET) facility being located at Culham, United Kingdom, where the British Government agreed to pay more than its proportional share of the costs for this European fusion program facility.

## 48 | The Fusion Energy Program: The Role of TPX and Alternate Concepts

of sustaining progress in fusion research by focusing on physics issues using existing smaller machines, increasing international collaboration, a modest effort in investigating alternative concepts, and concentrating on materials and technol-

ogy advances that would be necessary for fusion power reactors. Eventually, however, progress toward development of a fusion powerplant will require a commitment to construction of very expensive new facilities.

# The Tokamak Physics Experiment 3

In the fiscal year 1993 budget request to Congress, the U.S. Department of Energy (DOE) asked for \$20 million for “conceptual design and R&D” for a tokamak physics experiment (TPX) “to address the physics of tokamak improvements.”<sup>1</sup> This request was the culmination of an effort started in 1991 by DOE, in the wake of the cancellation of the Burning Plasma Experiment (BPX), to come up with a new experimental device to follow the completion of work on the Tokamak Fusion Test Reactor (TFTR). If completed, TPX would be the first large experimental magnetic fusion device built and operated in the United States since TFTR operation began in 1982. The principal focus of TPX is to examine a range of physics and engineering issues whose successful resolution could greatly reduce the cost and complexity of a commercial fusion powerplant based on the tokamak concept.<sup>2</sup> In addition, TPX is intended to support design and operation of the International Thermonuclear Experimental Reactor (ITER).

The principal features of TPX are to be its ability to explore advanced operating regimes that could substantially improve tokamak powerplant performance, and to operate at near steady-state conditions with a design plasma pulse length of 1,000 seconds.<sup>3</sup> TPX is to be built at the Princeton Plasma Physics Laboratory in the area currently occupied by TFTR. The most recent estimate of

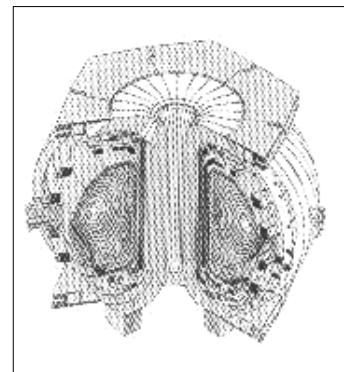

<sup>1</sup> U.S. Department of Energy, *FY1993 Congressional Budget Request*, DOE/CR-0006 (Washington, DC: January 1992), vol. 2, p. 390.

<sup>2</sup> U.S. Department of Energy, *Tokamak Physics Experiment*, UCRL-TB-114199 (Washington, DC: March 1993).

<sup>3</sup> *Ibid.*



total project cost—construction plus associated operations during construction—is \$694 million.<sup>4</sup> If TPX construction starts by the end of 1995, completion is expected in 2001. Once completed, operating costs are expected to be \$150 million per year for the project’s 10-year lifetime.<sup>5</sup>

This chapter presents an analysis of the TPX project. The chapter starts with a description of the process leading up to the TPX decision. Next, a description of the machine is given including its scientific and technical goals. Several of the issues about TPX emerge from this analysis.

## HISTORY OF THE TPX DECISION

The roots of TPX lie in the 1990 report of the Fusion Policy Advisory Committee (FPAC) to DOE.<sup>6</sup> That report set forth a series of recommendations to guide the future of the U.S. fusion energy program. The committee recommended that the United States “commit to fusion as a potential energy source,” that the program should be directed toward energy production, and that it should set as a specific goal the construction of a demonstration powerplant (DEMO) by 2025.<sup>7</sup> The committee also recommended that to achieve these goals, DOE needed to start four new facilities in the 1990s including: a burning plasma

experiment, ITER, a steady-state advanced tokamak, and a neutron source for materials development. These facilities would be necessary to investigate a series of important scientific and technical issues that needed resolution if magnetic fusion energy was to become a reality.

At the time of the FPAC report, DOE was proceeding with conceptual design of BPX and was a partner with Japan, the European Union, and Russia in the conceptual design activity of ITER. BPX was to be a moderately sized tokamak with very high magnetic fields. It was to be capable of achieving ignition (reaching the point where the fusion reaction becomes self-sustaining) for the purpose of investigating the properties of burning (self-heated) plasmas,<sup>8</sup> particularly behavior of a plasma dominated by alpha particle heating.<sup>9</sup> Such heating is expected to be the principal source of heating in a deuterium and tritium (D-T) fusion plasma once ignition is achieved. These results were expected to provide “valuable” input to ITER and ultimately, along with ITER, to be essential to reaching a DEMO by 2025. While BPX was expected to achieve a large net energy gain, it was not being designed for steady-state operation. That task was to be left to other, unspecified experiments, although the FPAC report did rec-

<sup>4</sup> This cost estimate was made prior to DOE’s submission of its fiscal year 1995 budget request. Since Congress did not grant approval for DOE to begin construction of TPX in fiscal year 1995, the cost estimate will probably increase.

<sup>5</sup> U.S. Department of Energy, *FY1995 Congressional Budget Request: Project Data Sheets*, DOE/CR-0026 (Washington, DC: February 1994), vol. 2., p. 90.

<sup>6</sup> U.S. Department of Energy, *Final Report, Fusion Policy Advisory Committee (FPAC)*, DOE/S-0081 (Washington, DC: September 1990).

<sup>7</sup> *Ibid.*, p. 3.

<sup>8</sup> U.S. Department of Energy, *FY1988 Congressional Budget Request*, DOE/MA-0274 (Washington, DC: January 1987), vol. 2, p. 327.

<sup>9</sup> One of the products of the fusion reaction between deuterium and tritium is the helium-4 nucleus, an alpha particle. These alpha particles, in turn, possess energy from the fusion reaction. The alpha particles are also subject to confinement by the external magnetic field, although they eventually diffuse out of the fusion plasma. While confined, the alpha particles can give up their energy by collisions with the deuterium and tritium in the plasma, helping to heat these ions to the point where they will undergo fusion reactions. Eventually, there will be sufficient heating in this manner to sustain the fusion reaction and ignition will be reached. There is speculation that the presence of large quantities of alpha particles may cause instabilities to appear in the plasma leading to excessive energy loss. Since no fusion plasma has reached ignition yet, investigation of such alpha particle instabilities has not been possible. Observations on TFTR where substantial fusion power has been produced, however, have indicated that such instabilities do not occur.

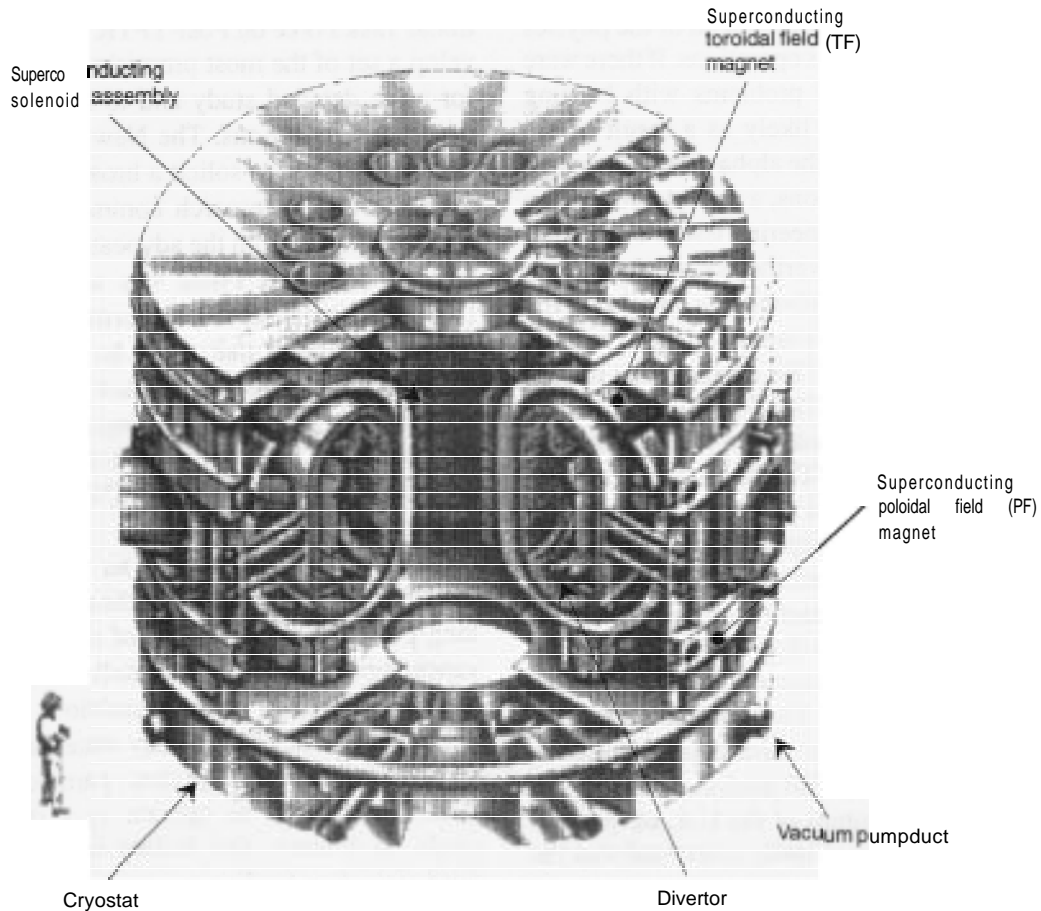

Major TPX components.

commend the construction of a steady-state tokamak.<sup>10</sup>

In 1991, however, it became clear that BPX would not be built. The estimated cost of the facility had reached \$1.4 billion and the Secretary of Energy Advisory Board (SEAB) Task Force on Energy Research Priorities recommended that DOE not proceed with BPX but concentrate on ITER.<sup>11</sup> Secretary of Energy Watkins ordered the cancellation of the project. Without the operation

of a BPX, it became necessary to transfer its areas of investigation to ITER. In other words, ITER would have to be a test bed for examining the physics of burning plasmas in addition to its other missions. It appeared that the demise of BPX meant an extension in the physics operating phase of ITER.

In addition, the added responsibilities would increase the overall project risk. Since ITER's principal function was to be an engineering test fa-

<sup>10</sup>A number of proposals for steady-state tokamaks had been put forward by different researchers. See for example, General Atomics and Lawrence Livermore National Laboratory, Technology and Physics in the Tokamak Program: The Need for an Integrated, Steady-State R&D Tokamak Experiment," GA-A19305, UCID-21404, May 1988.

<sup>11</sup>Ronald C. Davidson, memorandum to John Sheffield, Oct. 30, 1991.

cility, it depended on most if not all of the physics being resolved prior to its operations. If there were substantial, unexpected problems with burning plasma stability—most likely as a result of the presence and actions of the alpha particles created by the D-T fusion reactions, a considerable delay in investigating the engineering issues of a fusion reactor would result. Nevertheless, the decision to cancel BPX plus the likelihood that no other ITER partner would build a burning plasma facility, made it necessary that ITER perform that role.

Also contained in the Task Force report was the suggestion that DOE look for a “less costly follow-on device” once TFTR concluded its experiments.<sup>12</sup> This charge was passed on to the Fusion Energy Advisory Committee. The committee accepted the Task Force recommendation to terminate the BPX program, and recommended a new experimental facility to follow TFTR. The recommendations of the two advisory groups focused on a device costing “in the \$500 million class” that would “investigate improvements in the tokamak concept,” support the ITER project, and maintain the scientific momentum of the U.S. program.<sup>13</sup> The SEAB report specifically requested that the new device investigate improvements “that could suggest new operating modes for ITER. . . .”<sup>14</sup> One of the major concerns of DOE at the time was that when TFTR finished its work in the mid-1990s, there would be a decade at least in which there would be no major facility for U.S. fusion researchers to have access. ITER is not scheduled for completion until 2005 at the earliest.

Upon receiving the recommendations, DOE began to plan for the new machine. It set up a Na-

tional Task Force on Post-TFTR Initiatives to develop a set of the most promising design options for more detailed study and to identify the preferred design options. The New Initiatives Task Force was asked to solicit a broad range of input from the fusion research community, including forming groups from the advocates of the various options. The Task Force was asked to provide DOE with guidance on the critical physics and technology issues that could be investigated by this new machine. While the Task Force was given considerable scientific and engineering latitude, the constraint that the construction cost of any new facility should be in the \$500-million range was firm.

The Task Force finished its work in March 1992.<sup>15</sup> It recommended that the new facility be a long-pulse tokamak capable of investigating advanced operating regimes. It defined a long pulse as that required to ensure conditions within the plasma had reached a steady state, and that all equipment—power supplies, particle exhaust, etc.—would have to operate in a steady-state mode. In essence, this facility would fulfill the third of the four facilities recommended by FPAC, a steady-state advanced tokamak (SSAT). The Task Force recommended that the new facility limit most of its operations to deuterium plasmas, since providing the facility with the capability of extensive D-T operation at high energy gain would force the costs to go well beyond the \$500-million limit. Finally, in a follow-on report in May 1992, the Task Force recommended superconducting magnets for the machine. All of this

---

<sup>12</sup> Ibid.

<sup>13</sup> Ibid.

<sup>14</sup> Charles H. Townes, letter to Secretary James D. Watkins, Oct. 20, 1992.

<sup>15</sup> J. Sheffield et al., “Report of the New Initiatives Task Force,” Mar. 10, 1992.

could be accomplished, according to the Task Force, within the \$500-million total project cost limit.<sup>16</sup> The recommendation was accepted by DOE and design has proceeded. The TPX proposal at an estimated construction cost of \$597 million (in as spent dollars) was endorsed by the SEAB Task Force.

## DESCRIPTION OF TPX

### ■ Scientific Features

The New Initiatives Task Force report identified the class of initiatives it reviewed as TPX. That name has now been adopted for the SSAT recommended by the Task Force. The mission of TPX is to “develop the scientific basis for an economical, more compact, and continuously operating tokamak fusion reactor.”<sup>17</sup> Its principal feature will be its ability to operate at near steady-state conditions. TPX is being designed to achieve plasma pulse lengths of 1,000 seconds. This time is sufficient to ensure that the plasma has come to a steady-state equilibrium, both internally and with the surrounding vacuum vessel. To achieve this pulse length, a plasma current driven by the plasma itself—the “bootstrap” current—must be generated. In addition, current drive is to be assisted by the external heating mechanism. The bootstrap current, however, will make up about 70 to 90 percent of the total plasma current. While bootstrap current fractions in this range have been generated in some existing tokamaks, none of the experiments lasted long enough to reach a condition of

steady-state equilibrium, which is one of the goals of TPX.

TPX will also attempt to operate in an advanced tokamak regime. This regime can be characterized by parameters that measure the potential power density of the fusion plasma if operated with deuterium and tritium, and the efficiency of the confinement system.<sup>18</sup> Higher values of the potential power density permit a tokamak operating with deuterium and tritium and generating a given amount of fusion power to be smaller and/or require a lower magnetic field, and, therefore, to be less costly. Higher confinement efficiency is also important because it allows the device to be smaller and/or operate with a lower magnetic field while confining the energy from the fusion reactions sufficiently long to produce significant energy gain.

TPX is being designed to operate in a regime, defined by these two parameters, well beyond that of largest existing machines—JET and JT-60U (upgrade)—and greater than that assumed in the ITER design. Existing tokamaks with configurations closer to that proposed for TPX (most notably the DIII-D device at General Atomics) have achieved values of potential power density and confinement efficiency near that planned for TPX but not under steady-state conditions. Figure 3-1 shows the goals for TPX, their relationship to the other three machines and representative data points from the DIII-D device. The quantities on the two axes have no dimensions and are proportional to the parameter beta. As one moves up the

<sup>16</sup> The original charge to the Task Force (Davidson, *op. cit.*, footnote 11) specified that the new device should be “in the \$500 million” range. Although no indication was given in the memorandum about the reference point for those dollars, a September 1992 report by the Fusion Energy Advisory Committee on Program Strategy for U.S. Magnetic Fusion Energy Research stated that the amount was in “as-spent” dollars. The Task Force in its March 1992 report on the SSAT, estimated the cost of the machine at \$429 million in fiscal year 1992 dollars. In its fiscal year 1995 budget submission to Congress, DOE gave a cost estimates of \$597 million for total facility cost (actual construction cost) and \$694 million for total project cost. These figures are in as spent dollars as calculated using DOE construction cost escalation rates. That is, this number is the sum of the dollar amounts in the years the money is actually spent. Taking the Task Force estimate and projecting it forward using the same rates yields a figure of about \$540 million. Therefore, the original cost estimate was reasonably close—within 10 percent—to that determined after substantially more engineering design.

<sup>17</sup> The scientific features of TPX are described in detail in Princeton Plasma Physics Laboratory, “TPX: A National Facility for Steady-State Advanced Tokamak Research,” briefing paper prepared for OTA, July 13, 1994; and see footnote 29.

<sup>18</sup> Both of the potential power density and confinement efficiency are characterized by a parameter called beta, which is the ratio of pressure exerted by the hot plasma to the pressure exerted by the external magnetic field.

FIGURE 3-1: Comparison of TPX Operating Regime to Other Tokamaks

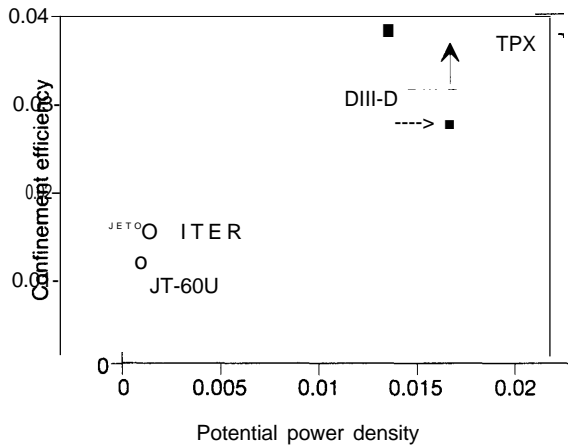

SOURCE: Office of Technology Assessment, 1995

vertical scale at a given point on the horizontal axis, the magnetic field and/or machine size required to achieve a given fusion power gain decrease. Moving in the horizontal direction at a given point on the vertical scale allows a machine to produce a given amount of fusion power at a reduced magnetic field and/or size. In either case, the cost per unit of fusion power would decrease because of the importance of the magnetic field size to machine cost. The parameters selected for TPX are those that, if achieved, could considerably reduce the cost of an eventual tokamak fusion powerplant.

While the TPX design values have been reached on other experimental devices, they have not been matched at steady-state conditions. Indeed, in cases where similar values of beta—about 5 to 6 percent—have been reached, the plasma has proved unstable after a few seconds. A key goal of TPX is to investigate the physics necessary to eliminate this instability and allow the parameters to be held continuously as will be required in a tokamak fusion power reactor. Theoretical predictions show that these instabilities can be

controlled by adjusting the shape of the main tokamak current. Such changes will be made on TPX with the external heating mechanisms (see below). Machines where the instability has been observed do not yet have as much flexibility for changing plasma current shape as is planned for TPX.

Reaching the parameters planned for TPX requires the ability to form the cross-section of the plasma into a shape resembling the letter D. This change has been shown to improve both confinement efficiency and potential power density. In short, such shaping allows a tokamak plasma to operate at a higher beta value than if it had a circular cross-section. Figure 3-2 shows cross-sections of various tokamak plasmas now in operation compared to that proposed for TPX. Note the D-shapes for DIII-D and TPX compared to the circular cross section for TFTR. There are two parameters that characterize the plasma cross-section: elongation (referring to the stretching of the plasma) and triangularity (referring to the approximate triangular shape). A circular plasma cross-section has an elongation of 1 and a triangularity of 0. TPX is being designed to have an elongation of 2 and a triangularity of 0.8. These parameters are similar to those on the DIII-D device.

TPX will have three heating options. The plasma can be heated by injecting energetic beams of neutral particles—aided neutral beam injection heating—as is now done on TFTR, or it can be heated by pumping electromagnetic power into the plasma. If the frequency of the electromagnetic power resonates with a characteristic frequency of the ions in the plasma, heating can take place. Two such frequencies are particularly useful. These methods are called ion cyclotron radiofrequency heating and lower hybrid current drive heating. External heating will also contribute to the steady-state current in the plasma and to shaping the plasma current for stability purposes as discussed above. As with the other characteristics discussed above, these heating methods have been applied to other tokamaks with success. Operating

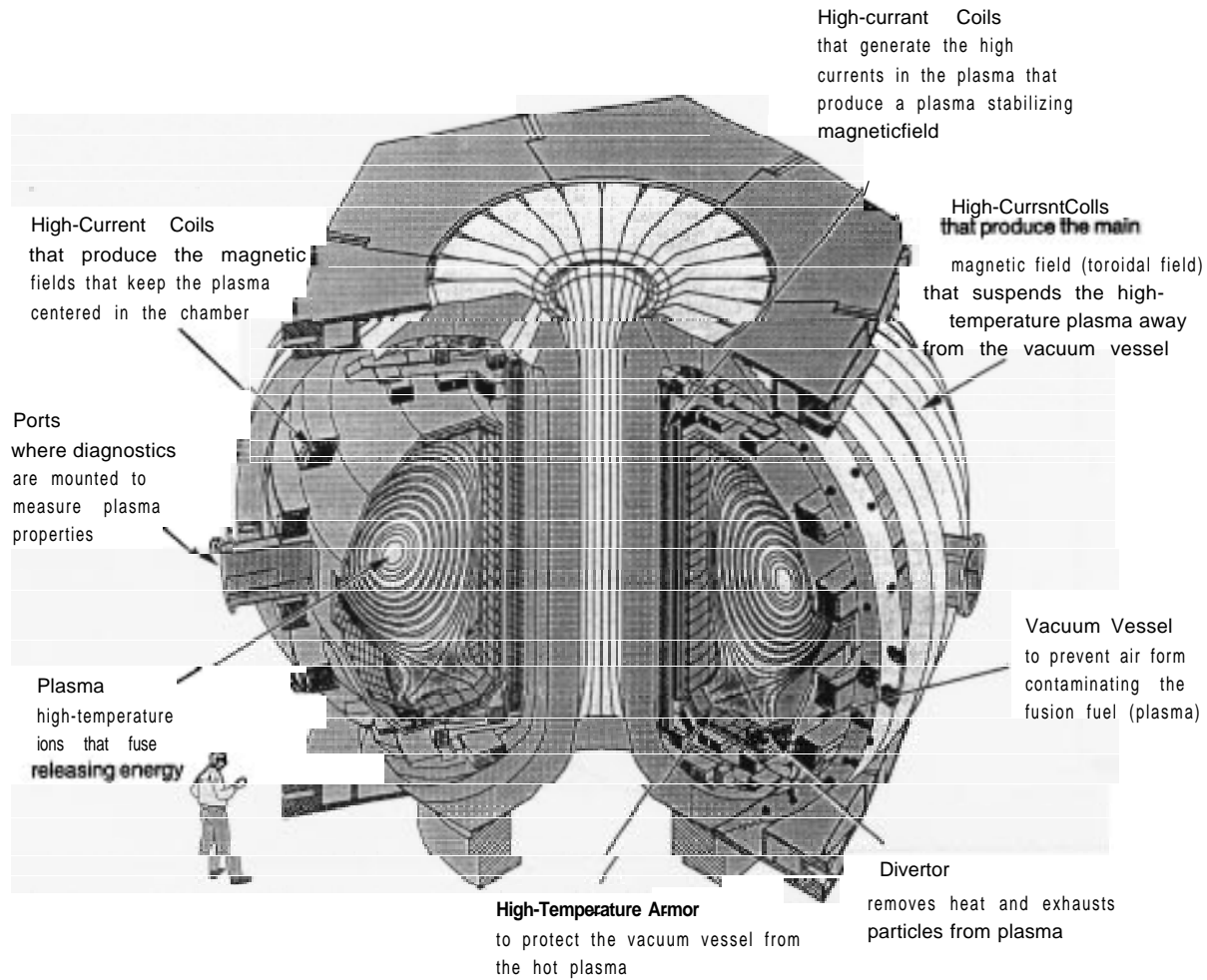

Diagram of General Atomics DIII-D Tokamak showing major components.

these heating methods in a steady-state environment, however, remains to be investigated.<sup>19</sup>

TPX will operate with deuterium to form the plasma since it is more desirable than hydrogen for achieving advanced operating conditions.<sup>20</sup> The use of deuterium, however, will produce fusion reactions and a significant quantity of neutrons (although considerably fewer than would result if deuterium and tritium were used). The

presence of neutrons will require remote handling and shielding that would not be necessary if only hydrogen were being used. To achieve the performance sought for TPX with hydrogen, however, would require a much larger machine and neutral beam system than with deuterium alone. The net result of these two competing cost factors is a less costly machine with deuterium.

<sup>19</sup>It should be noted that current reactor design studies conclude that neutral beam heating and lower hybrid current drive are not likely to be practical for fusion powerplants.

<sup>20</sup>Robert Goldston, Princeton Plasma Physics Laboratory, personal communication, July 13, 1994.

**FIGURE 3-2: Comparison of Plasma Cross-Sections of Selected Large Tokamaks**

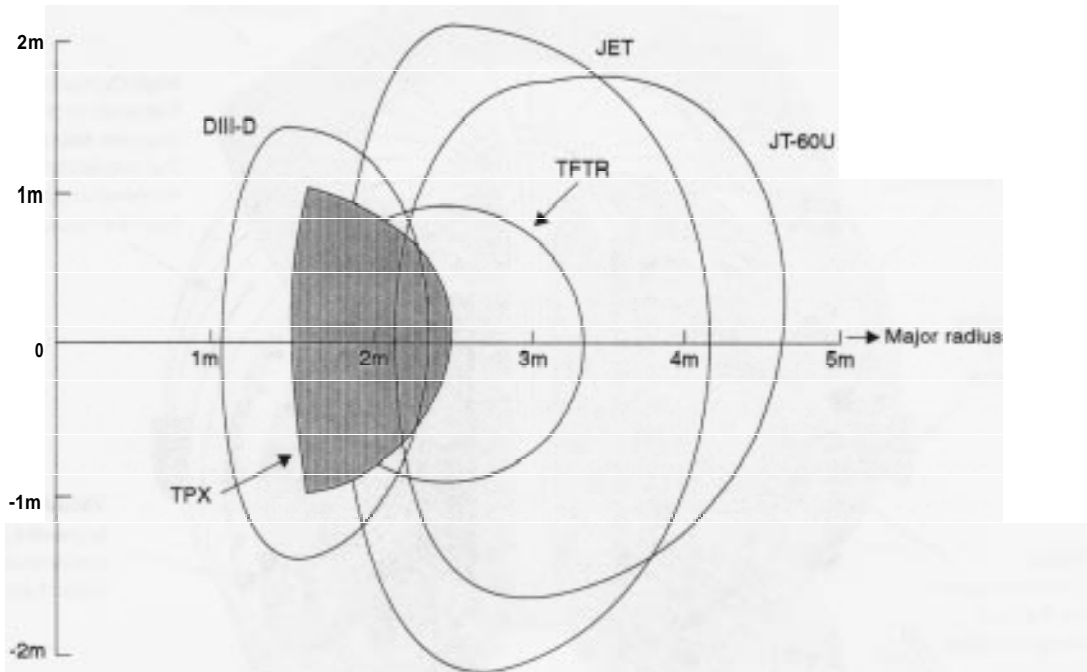

DIII-D = General Atomics, USA;  
 JET = Joint European Torus, European Community, Culham Laboratory, U. K.;  
 JT-60U = JT-60 Upgrade, Japanese Atomic Energy Research Institute, Japan;  
 TFTR = Tokamak Fusion Test Reactor, Princeton Plasma Physics Laboratory, USA;  
 TPX = Tokamak Plasma Experiment, Princeton Plasma Physics Laboratory, USA

SOURCE: Office of Technology Assessment, 1995, based on a figure provided by David Overskei, General Atomics.

**■ Technological Features**

There are several important technology issues that will be investigated on TPX.<sup>21</sup> First, TPX will be a fully superconducting tokamak. That is, all of the external magnet systems will be superconducting. While other tokamaks have had superconducting magnets, they have been confined to the main toroidal (donut-shaped) fields. The other major magnet system, called the poloidal field system, which is responsible for inducing the initial plasma current and shaping the plasma cross-

section, has not been superconducting on any previous tokamak. The second feature will be the requirement that the superconducting magnets be capable of running essentially steady state. Because TPX will be operating with current pulses 1,000 seconds or longer, the toroidal magnetic field must be on continuously. Previous superconducting tokamaks have only had plasma pulse lengths of up to 60 seconds. It should be noted, however, that the superconducting toroidal field coils of the Tore Supra tokamak (a large tokamak

<sup>21</sup>For a discussion of the technological features, see Sheffield et al., *op. cit.*, footnote 15.

operating in France) have been kept on for eight to 10 hours at a time.

Full-power operation of TPX is now projected to be about 200,000 seconds (55 hours) per year. While a small fraction of the total number of hours in a year, this period is considerably greater than current tokamaks. The limiting factor will be the degree of human access required for maintenance in the region outside the vacuum vessel. Because the vessel will become radioactive as a result of being struck by neutrons from the plasma, such access will require that the flux of neutrons be kept below a certain level, hence a limitation on the number of hours the machine can operate. This feature will be discussed more completely below. Not all of TPX experimental runs would be at the full 1,000-second pulse. Rather, runs with pulse lengths on the order of 100 to 200 seconds would be made testing various operating conditions. Only for those conditions that appear to be particularly interesting in terms of the TPX goals would 1,000-second or longer pulses be operated. Finally, the machine will be designed to operate for 500,000 seconds (about 140 hours) per year at reduced power. It is expected that these conditions will be used during startup of the machine.

Another critical area of investigation for TPX will be the divertor. Interaction between the plasma and the wall of the surrounding vacuum vessel takes place at the divertor. In any tokamak plasma, energy eventually escapes through the loss of the energetic particles making up the plasma and by radiation. The divertor is designed to capture and cool these escaping particles. The charged particles are also neutralized at the divertor and the resultant gas is exhausted from the vacuum chamber. Because the heat and particle load leaving a typical fusion reactor plasma will be very large, design of a divertor that can withstand such a load is critical. It is one of the factors that will determine the size of the tokamak. The higher the heat load that can be handled by a given divertor, the smaller the entire machine can be for a given pow-

er output. TPX is being designed to test different configurations. The TPX divertor system will be completely replaceable using remote handling technology. The divertor design is being made as flexible as possible. Finally, the steady-state nature of TPX is critical to investigating the steady-state behavior of various divertor arrangements.

Remote handling is another technological area that will be investigated on TPX. As described above, there will be significant numbers of neutrons formed during TPX operations. It will be necessary, therefore, to be able to make changes within the machine remotely using robotics. Since such handling will also be necessary on any fusion power reactor, the ability to test and develop these remote handling capabilities is a key feature of TPX. The radiation environment inside the machine will be kept low enough, however, to allow limited human access. The vacuum vessel, and many of its internal components, will be constructed of a material that produces a low quantity of radioactive byproducts when subjected to the flux of neutrons. Such materials are called low-activation materials. It is also possible that TPX can be a test facility for exposing different kinds of low-activation materials to a steady-state tokamak environment. Similarly, shielding in the wall of the vacuum vessel surrounding the plasma will be necessary to keep neutrons from the superconducting magnets. If neutrons reach the magnets in sufficient numbers, the resultant heating would cause them to heat up and lose their superconductivity. Testing shielding technologies will be useful for eventual fusion power reactors.

## ISSUES

### ■ Relation to Existing Tokamaks

TPX is being designed as a national facility.<sup>22</sup> The design team is made up of members from various universities, other national laboratories, and representatives of industry. Once completed, TPX operations will be guided by an oversight council

<sup>22</sup> U.S. Department of Energy, *op. cit.*, footnote 2.



with similar representation. Experiments will be performed by researchers from participating institutions throughout the nation under the guidance of this council. TPX will be integrated into the national information infrastructure so that researchers can perform experiments from their home institution. This situation is being created in order to facilitate one of the principal functions of TPX—that it be a centerpiece in maintaining a strong national research capability in fusion science and engineering.

The New Initiatives Task Force made an assessment of several existing tokamaks to see if the goals of TPX could be met on one of them.<sup>23</sup> There are two other large, superconducting tokamaks in existence, the Tore Supra in France and the T-15 in Russia. Both devices have superconducting toroidal coils like TPX, but neither have superconducting poloidal coils. The Tore Supra appears to have the potential for long-pulse (about 600 second) operation. Both, however, have fusion plasmas with circular cross-sections and, therefore, are incapable of achieving the advanced operating parameters designed for TPX. The DIII-D device at General Atomics in San Diego has the necessary plasma shaping capability to test the advanced features and create the high bootstrap current fractions that are features of TPX. The DIII-D, however, cannot maintain the long pulses because its current magnet power supply configuration and plasma heating supplies are incapable of operation for the long periods needed for the 1,000-second pulses. Also, the DIII-D device cannot accommodate the large divertors planned for TPX without a significant reduction in plasma size.

The remaining large tokamaks are JET, JT-60U, and TFTR. None of these machines oper-

ates with superconducting magnets. Further, both JET and TFTR are committed for investigation of D-T plasma operation for the rest of their operational life. While capable of operating in advanced modes, as seen in figure 3-1, JT-60U will not be able to match the planned operating conditions of TPX, nor of sustaining very long pulses. Based on the capability of its magnet system, pulses of 45 seconds are about as long as could be expected on that machine. The Japanese have also carried out a conceptual design of a superconducting machine called the JT-60 Super Upgrade.<sup>24</sup> It would have many of the features planned for TPX and would be larger and more powerful. Construction has not been approved, however, and its fate may depend on funding resources in Japan and whether TPX is built. In any case, the JT-60 Super Upgrade is seen as possible by Japanese research funding authorities only if ITER is not sited in Japan.

Finally, none of the current machines can match the planned, high-duty cycle of TPX. A key parameter in determining duty cycle is the annual flux of neutrons produced by fusion reactions of the deuterium used for TPX plasma. These neutrons will impinge on the inner wall of the vacuum vessel and on the divertor resulting in a steady buildup of radioactive material in these structures. In addition, neutrons that escape the ports in the vacuum vessel will activate structures outside the vessel. To keep the activation levels of such material below that which can be handled without costly procedures puts an upper limit on the neutron flux that can strike these structures. Also, DOE's site boundary dose limits (30 times lower than background) must be observed. TPX is being designed to accept an annual neutron flux of  $6 \times 10^{21}$  neutrons. The other machines are limited to neu-

<sup>23</sup> Sheffield et al., *op. cit.*, footnote 15, ch. 3.

<sup>24</sup> H. Ninomiya et al., "Conceptual Design of JT-60 Super Upgrade," paper presented at the 15th International Conference on Plasma Physics and Controlled Nuclear Fusion Research, Seville, Spain, Sept. 26 - Oct. 1, 1994.

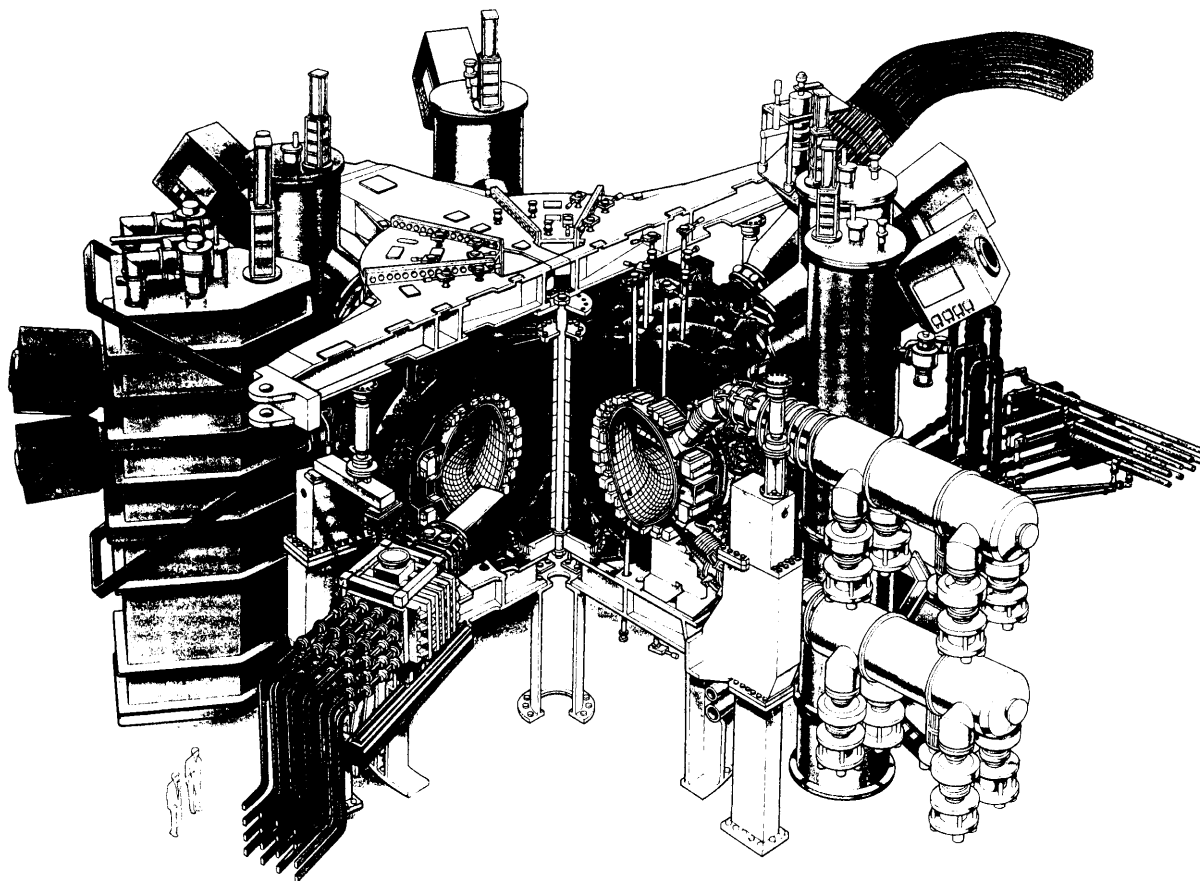

The JT-60U tokamak in Japan.

tron fluxes 10 to 100 times less than TPX design because of their structural materials. Table 3-1 summarizes the principal parameters of the tokamaks discussed in this section compared to TPX.<sup>25</sup>

### ■ Relation to ITER

The FPAC report included both an engineering test reactor and a steady-state advanced tokamak among its recommended facilities. Much of the conceptual design activity (CDA) work on ITER was complete before the TPX initiative began,

however, and the final report of the CDA was vague about whether a TPX-like machine would be operative in time to provide ITER with any design or operational guidance.<sup>26</sup> Indeed, it was assumed at the time that a burning plasma facility would be the one constructed. The ITER CDA report did define physics and technology R&D that would be needed to “validate the scientific and technical basis and assumptions” for the ITER design.<sup>27</sup> Included were several of the areas that are planned to be investigated by TPX such as long-pulse operation, improved divertor performance,

<sup>25</sup> Sheffield et al., *op. cit.*, footnote 15, ch. 3; and Princeton Plasma Physics Laboratory, *op. cit.*, footnote 17.

<sup>26</sup> International Atomic Energy Agency, *ITER Conceptual Design Activities: Final Report*, ITER Documentation Series, No. 16 (Vienna, Austria: 1991).

<sup>27</sup> *Ibid.*, p. 14.

## 60 The Fusion Energy Program: The Role of TPX and Alternate Concepts

TABLE 3-1: Tokamak Comparison Table

Parameter	TPX	TORE SUPRA	T-15	DIII-D	JT-60U	JET
Major radius (meters)	2.25	2.38	2.43	1.67	3.4	3.1
Minor radius (meters)	0.5	0.75	0.70	0.67	0.85	1.1
Toroidal field (T)	4	4.5	3.5	2.1	4.2	3.4
Plasma current (MA)	2	2	1.4	2.1	6.0	6.0
Elongation	2	1.0	1.0	2.0	1.6	1.8
Pulse length (see)	1,000	<b>20</b>	?	<b>10-60</b>	<b>20-30</b>	<b>15-30</b>
Neutron budget (ns/yr)	6x10 <sup>21</sup>	1.2x10 <sup>20</sup>	?	3x10 <sup>18</sup>	<10 <sup>21</sup>	>10 <sup>21</sup>
Country	Proposed U.S.	France	Russia	Us.	Japan	U.K.

KEY

JET = Joint European Torus

MA = mega-amperes

ns/yr = neutrons per year

T = tesla

TPX = Tokamak Physics Experiment

SOURCE: J. Sheffield et al., "Report of the New Initiatives Task Force," Mar. 10, 1992.

superconducting magnets, remote handling, and plasma heating and current drive systems. The ITER CDA assumed that this research and development (R&D) would be done on existing tokamaks and that ITER would be responsible for integrating all these features along with its other goals.<sup>28</sup> On that basis, one could conclude that the ITER project was proceeding under the assumption that no steady-state advanced tokamak would be built.

While it is planned that TPX will investigate many of these ITER CDA R&D needs, operation is not scheduled to begin until ITER construction is underway according to the current plans. This situation was recognized by the team that developed the report on TPX (SSAT) to the New Initiatives Task Force early in 1992. The report stated that TPX operations would be able to provide valuable operating experience on long-pulse, high-duty factor operation for later operations of

ITER.<sup>29</sup> In addition, construction of the superconducting magnets would give U.S. industry important experience as a prelude to the task of constructing the ITER magnets. Finally, TPX would serve as a central research facility for U.S. researchers while ITER was under construction.

The ITER design activity seems to be attempting to make a greater connection between it and TPX. There have been discussions between TPX and ITER design teams about divertor systems. Currently, the two machines are using different divertor designs with ITER proposing a more conservative configuration. TPX, however, has the capability of investigating the divertor configurations planned for ITER. Comparison of the different designs should permit TPX to make important contributions to the divertor choice for DEMO. A more important connection concerns the advanced operating mode investigations of TPX.

<sup>28</sup> Ibid.

<sup>29</sup> Keith Thomassen et al., Lawrence Livermore National Laboratory, *Steady State Advanced Tokamak (SSAT): The Mission and the Machine* (Springfield, VA: National Technical Information Service, March 1992).

Currently, ITER is being designed fairly conservatively in terms of the confinement efficiency and potential power density parameters. From figure 3-1 above, it lies considerably below the design variables for TPX. Originally, ITER was to be configured to operate in a regime closer to that of TPX. These parameters were changed because such operation would have entailed more risk for ITER, since the fusion power produced would have taxed the limits of the materials used for the vacuum vessel. While TPX proposal did not spark these changes, results from TPX related to the advanced operating regimes, as discussed below, would be useful for ITER.

The ITER design group recently indicated its desire to maintain the flexibility of performance in steady-state advanced tokamak regimes in the later phases of its operation to permit study of advanced operating regimes in ITER. Significant upgrades to auxiliary systems may be required for these tests, but it appears that ITER could ultimately approach TPX conditions in a D-T plasma operating at high energy gain. A major question is the cost involved. To build in the flexibility so that ITER could fully explore this advanced, steady-state regime may be very expensive. Recent work has shown that while ITER is being designed for lower elongation and triangularity (see figure 3-1) than TPX, calculations indicate that values approaching those of TPX can be attained in ITER at reduced plasma current.<sup>30</sup> At this time, the ITER design team seems intent on preserving this capability. The ITER interim design, expected in June 1995, should allow a better assessment of whether this is indeed the case.

Achieving the ideal operating conditions will require optimizing several parameters. Whether TPX, with its ability to shape the plasma cross-section to a greater degree than ITER, is more successful than ITER at reaching these conditions remains to be determined by experiment. Results

from TPX in this context should be valuable for ITER.

In addition, in many of the technology areas—such as superconducting magnets and remote handling and shielding—ITER will have to be operating at least on par with TPX if not in advance of it, since ITER demands will be substantially greater due to its D-T operation. Experimental results on TPX, if they precede ITER operation by a sufficient period, could be of value.

Unless they can be tested in ITER, there will likely be considerable uncertainty about integrating TPX results with those from ITER in designing and building DEMO. There is no question that successful achievement of many of the goals to be investigated by TPX—steady-state operation, superconducting magnets, remote handling, and advanced divertor design in particular—will be necessary if a tokamak-based fusion power reactor is to become a reality. As discussed above, these areas can be incorporated in ITER from the start or be integrated into it after testing elsewhere, preferably on TPX. Integration of advanced tokamak operations results into ITER, however, may be more limited and require significant upgrades. Since successful demonstration of these operations can have significant consequences for the economics of a fusion power reactor using the tokamak concept, it will be important to build them into the DEMO design. Indeed, if operation in the advanced regimes has not been demonstrated, the economics of a tokamak fusion powerplant may be not be attractive enough to be accepted by the market. Demonstrating advanced operations may be the most important contribution of TPX. TPX, therefore, is designed to be upgradeable for operation with deuterium and tritium. Doing so, however, would eventually add to the cost of TPX. Such expenditures may prove beneficial since D-T operation in TPX could complement D-T experiments in ITER and provide important data for

---

<sup>30</sup> W. Nevins et al., "ITER Steady-State Operation and Advanced Scenarios," IAEA-CN-60/E-P-5, paper presented at the 15th International Conference on Plasma Physics and Controlled Nuclear Fusion, Seville, Spain, Sept. 26-Oct. 1, 1994.

## 62 The Fusion Energy Program: The Role of TPX and Alternate Concepts

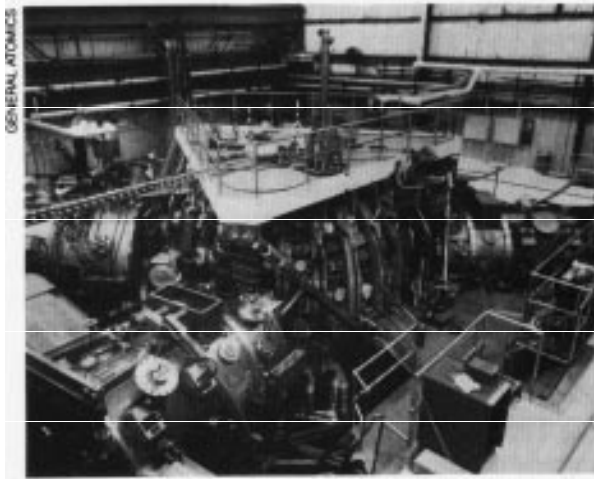

The DIII-D Tokamak at General Atomics in San Diego.

DEMO. It is likely that DEMO will be designed rather conservatively because of the potentially high cost of that machine. To the degree that advanced operation has not been tested in a D-T, steady-state device such as ITER, the risk of incorporating that feature into DEMO may be too great.

### ■ Stand-Alone Machine

Supporters of TPX argue that the machine's value is not dependent on the ITER even though many of the scientific and technical issues that TPX will investigate are important for ITER. They say that some of the results from TPX will be useful regardless of the path fusion power development takes. In particular, operation of superconducting magnets and remote handling will be necessary on any magnetic fusion reactor. In addition, there will be need for a divertor or similar device to remove heat and particles from a burning plasma. Results of physics investigations on steady-state and advanced operations can also be useful to a variety of other magnetically confined concepts since they, too, will have to operate continuously and will be concerned with some of the same issues about power density and confinement efficiency

gain. Much of the steady-state and advanced operation issues to be investigated by TPX, however, are unique to the tokamak concept. For that reason, the results of the advanced operation experiments may be essential in evaluating the tokamak against alternative concepts should the latter fusion program be redirected toward more effort on such concepts.

Another important function of TPX, as described above, is to serve as a national facility. Without such a machine, there does not seem any prospect for a new large, magnetic fusion experimental facility in the United States in the next several years after TFTR shuts down. Several other U.S. tokamaks would remain in operation, however, the largest of which is the DIII-D facility at General Atomics in San Diego. While possessing many of the features of TPX, DIII-D is not now capable of steady-state operation for the reasons described above. In addition, it is not now a national facility in the sense that TPX is intended to be. Access to DIII-D by researchers outside of General Atomics, however, has been quite good.

Another possible scenario for the magnetic fusion energy program is that ITER is indefinitely postponed, but no other alternative concept emerges to challenge the tokamak.<sup>31</sup> In that case, TPX could be of even more value than currently is the case. As previously stated, the physics and technology it is investigating are fundamental for the development of any tokamak-based fusion power reactor. It also seems clear that while TPX will expand the state of knowledge about advanced tokamak operation, successful steady-state operation in that regime is by no means certain. Particular issues that need resolution concern how steady-state operation affects density and current profile-shaping for generating the bootstrap current and attaining higher values of potential power density and confinement efficiency. Similarly, there is still much R&D to be done to come up with a divertor that can operate reliably

<sup>31</sup>For one discussion of different timing and mix of major tokamak facilities leading to a demonstration powerplant, see Stephen O. Dean, "Fusion Power Development Pathways," *Journal of Fusion Energy*, vol. 12, No. 4, 1993, pp. 415-420.

FIGURE 3-3: Estimated TPX Construction Funding Schedule

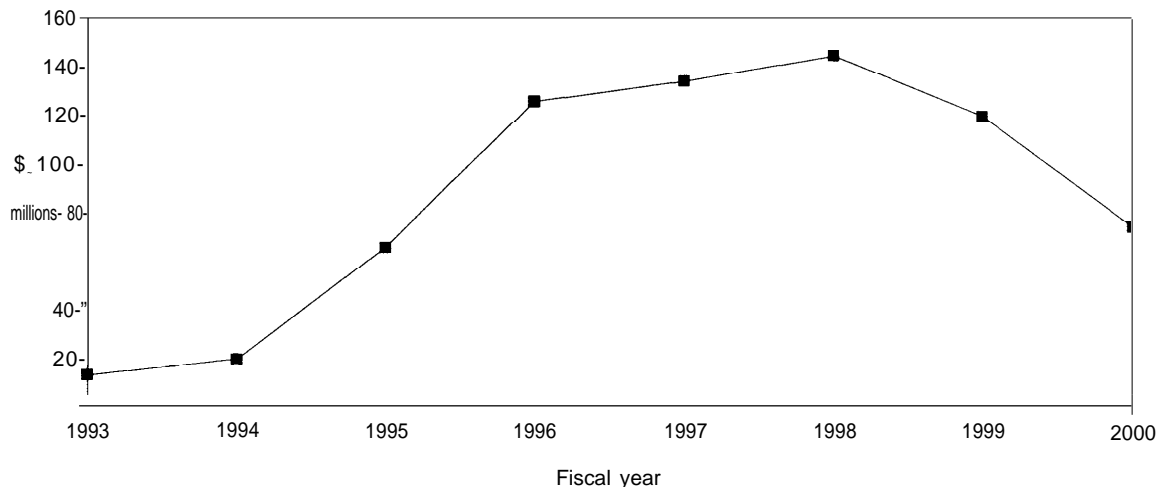

SOURCE Off Ice of Technology Assessment, 1995

under steady-state conditions. If TPX is built and these important physics and engineering problems are solved, the possibility of developing a successful tokamak-based fusion power reactor would be significantly higher.

### ■ cost

As proposed in the DOE fiscal year 1995 budget request to Congress, the total project cost estimate of TPX is \$694 million to completion. This estimate includes \$597 million for actual construction and \$97 million for associated research during the construction period and other related costs. These costs are all in as spent dollars. The cost profile as envisioned in the fiscal year 1995 request is given in figure 3-3. This plan called for \$66.9 million in fiscal year 1995. Congress, however, appropriated \$42 million and did not grant approval to start construction. At this time, the fiscal year 1996 budget request is uncertain. In addition, the spending profile will also change, but, assuming project construction is approved, the annual amounts needed are not likely to decline

from those shown. Currently, DOE is projecting annual operating costs of \$150 million (in fiscal year 2000 dollars) for the 10-year life of the facility.

The budget requirements for TPX construction when combined with DOE commitments to the ITER program, even before its construction, would result in a large increase in the total MFE budget unless the base program is greatly reduced. While some reduction can be expected as TFTR operations are phased out, it is not likely to be sufficient to keep the total budget requirements from growing sharply. At the same time, there have been calls to reduce the magnetic fusion energy budget by as much as 50 percent. It is clear, therefore, that gaining approval to begin TPX construction is likely to be difficult. Given the Japanese interest in a machine with similar characteristics—the JT-60 Super Upgrade—it may be desirable to explore the possibility of making TPX an international venture just as the ITER project, or otherwise integrating it more fully into the international fusion energy effort.

# Alternate Concepts for Fusion Energy 4

Over the past several decades, the tokamak has emerged as the most scientifically successful fusion energy concept, and is emphasized in U.S. and world programs. There are, however, a number of alternate concepts (i.e., nontokamak) for fusion energy for which the knowledge base is more limited (see table 4-1). Some of these may have potentially attractive characteristics. In the past several years, alternate concepts have received a declining fraction of the federal fusion energy program budget, leading to the current state in which nearly all emphasis is placed on the tokamak. This chapter addresses the following questions regarding alternate concepts:

- What is the rationale for pursuing alternate concepts as part of a fusion energy program?
- What is the current status of knowledge for alternate concepts?
- What activities are involved in pursuing an alternate concept?
- What is the Department of Energy's (DOE's) current program for alternate concepts?

## REASONS TO PURSUE ALTERNATE FUSION CONCEPTS

There is widespread agreement that examination of alternate fusion confinement concepts is an important component of a fusion energy program. The Office of Technology Assessment's 1987 report found that "the characteristics, advantages, and disadvantages of various confinement concepts need further study"<sup>1</sup> for

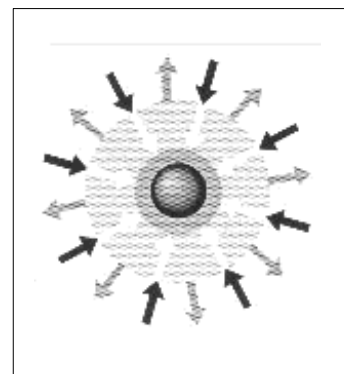

<sup>1</sup> U.S. Congress, Office of Technology Assessment, *Starpower: The U.S. and the International Quest for Fusion Energy*, OTA-E-336 (Washington, DC: U.S. Government Printing Office, October 1987), p. 11.

TABLE 4-1: Fusion Concepts

**Low density magnetic confinement**

Tokamak  
 Field reversed configuration  
 Spheromak  
 Spherical tokamak  
 Reversed field pinch  
 Stellarator

**Inertial fusion energy (IFE)**

Conventional IFE (e.g., heavy-ion, laser)  
 Advanced, decoupled-ignition, target systems  
 Magnetized-target IFE  
 Focused-ion fast ignition  
 Z-pinch fast ignition

**High density magnetic confinement**

Z-pinch  
 Z-Flow-through pinch  
 Wall-confined, magnetically insulated

**Nonthermonuclear**

Inertial electrostatic confinement  
 Colliding beam systems (e.g., MIGMA)

**Coulomb barrier reduction**

Muon catalysis  
 Others (e.g., antiproton catalysis)

SOURCE: R. Paul Drake et al., Lawrence Livermore National Laboratory, "Advanced Fusion Assessment," Aug. 19, 1994

several reasons, including uncertainty about which concept can form the basis of an attractive fusion powerplant. In 1990, the Secretary of Energy's Fusion Policy Advisory Committee (FPAC) reported:

. . . there must be an independent program of concept improvement, including study, and where promising, development of alternative

configurations that may be more suitable for commercialization.<sup>2</sup>

Similarly, in its June 1992 report to the DOE Director of Energy Research, the Fusion Energy Advisory Committee (FEAC) recommended:

. . . a non-tokamak fusion concept program, at some level, should be supported as a matter of policy. FEAC recommends that DOE retain the flexibility to test some non-tokamak concepts at intermediate scale when warranted by their technical readiness and promise as a reactor.<sup>3</sup>

There are several reasons for supporting alternate concepts as part of a fusion energy program, including reducing risk, identifying more commercially attractive concepts, identifying tokamak enhancements, and promoting competition in research. Reducing risk and identifying potentially more attractive prospects have been most widely cited, including by FPAC, FEAC, and OTA.

**Reduce Risk**

The tokamak has clearly emerged as the most scientifically successful fusion energy concept. However, while there is widespread agreement that a tokamak powerplant is *likely* to be scientifically and technically feasible, it may ultimately prove not to be, and thus pursuit of alternate concepts reduces the risk of having no fusion energy option should the tokamak prove infeasible. The remaining physics challenges and uncertainties in developing a tokamak fusion energy device are substantial. For example, it is still to be demonstrated that a tokamak plasma can be ignited and that an ignited plasma can be maintained in steady state. There are extensive technology challenges as well, such as developing a divertor (a device to control impurities and remove reaction products)

<sup>2</sup>U.S. Department of Energy, Fusion Policy Advisory Committee, *Report of the Technical Panel on Magnetic Fusion of the Energy Research Advisory Board, Final Report*, DOE/S-0081 (Washington, DC: September 1990), p. 4.

<sup>3</sup>Fusion Energy Advisory Committee, *Advice and Recommendations to the Department of Energy in Partial Response to the Charge Letter of September 24, 1991: Part D*, DOE/ER-0555T (Washington, DC: U.S. Department of Energy, Office of Energy Research, June 1992), June 1992, p. 11.



**TABLE 4-2: Challenges to Tokamak as a Commercially Attractive Fusion Energy Concept**

<b>Characteristic</b>	<b>Cost/performance implication</b>
Low power density	High capital cost per kW produced
High complexity	Low perceived reliability/maintainability
Large unit sizes of >2 GW (thermal)	Inflexible for power system planning
Deuterium and tritium fuel	Not radioactively benign
Very high development costs	

SOURCE: R Paul Drake et al., Lawrence Livermore National Laboratory, "Advanced Fusion Assessment," Aug. 19, 1994.

and developing advanced materials well suited for the challenging environment of a magnetic fusion energy (MFE) reactor.<sup>4</sup>In all, tokamak proponents suggest that meeting the existing challenges to making a demonstration fusion powerplant will take a continuous, high-level effort extending more than three decades. This multidecade time horizon for fusion energy development and the substantial challenges ahead suggest the importance of breadth and flexibility in the program.

### ■ Identify More Commercially Attractive Concepts

Even if a tokamak energy device ultimately proves scientifically and technically feasible (which most observers believe is likely), it may not be commercially attractive. There are several tokamak concept characteristics that may lead to a commercially unattractive reactor product. Without significant technical breakthroughs, these characteristics could cause tokamak energy devices to have inherently high capital costs, difficult maintenance, large unit sizes, and other unattractive features, as shown in table 4-2.<sup>5</sup>Re-

cent reactor studies performed for the fusion energy program indicated that the cost of electricity from a fusion powerplant based on the tokamak concept would be somewhat in excess of today's best fission powerplants, assuming all scientific and technical feasibility challenges are met over the next several decades.<sup>6</sup>Table 4-3 summarizes criteria identified by electric utility industry personnel as important for practical fusion power systems.

Pursuing alternate concepts, including novel ones, may provide a breakthrough for an ultimately more economic fusion energy device. There are several alternate concepts that in theory address some of the challenges associated with the tokamak. However, their scientific and technical development remains inadequate to determine likely feasibility. It should be noted that there is at present no alternate concept that appears superior to the tokamak. Rather, there is insufficient information to determine the long-term prospects of many alternate concepts. While an alternate concept may appear promising, the relative lack of information and technical development for most

<sup>4</sup>Many technology challenges facing the tokamak would also have to be addressed by some alternate concepts, but there are many exceptions. For example, by using a liquid wall of materials not subject to neutron activation or degradation, by its very nature, the inertial fusion energy concept need not require the same advanced materials. Similarly, alternate concepts involving fusion of certain fuels other than deuterium and tritium such as helium-3 would result in less extensive production of high-energy neutrons, and thus may not require the same developments in advanced materials as needed for the tokamak.

<sup>5</sup>L.J. Perkins et al., Lawrence Livermore National Laboratory, "Fusion, the Competition and the Need for Advanced Fusion Concepts," paper prepared for OTA Workshop on Fusion Energy, June 8, 1994.

<sup>6</sup>F. Najmabadi et al., "The ARIES-I Tokamak Reactor Study," UCLA-PPG-1323, 1991.

**TABLE 4-3: Criteria for Practical Fusion Power Systems**

**Economics—lower lifecycle costs than competitors**

- Plant size flexibility
- Short, simple construction schedule
- Design simplicity
- High reliability, availability
- Low fuel costs
- Long life
- Low end-of-life costs

**Public acceptance**

- Environmental attractiveness, minimal radioactive wastes
- Low costs
- Maximum safety

**Licensing simplicity**

SOURCE: Office of Technology Assessment, adapted from Jack Kaslow, Electric Power Research Institute, "Criteria for Practical Fusion Power Systems," presentation to the Fusion Energy Advisory Committee, Dec. 1-2, 1994.

makes that promise speculative. In contrast, the advanced state of development of the tokamak makes it relatively easy to identify its likely shortcomings—less well developed alternate concepts may well have shortcomings that will not be identified without further development efforts.

**■ Identify Tokamak Enhancements**

Even if the tokamak proves to be the most commercially attractive fusion concept, research on alternate concepts can support tokamak improvement and technology development. A current example is the field reversed configuration (FRC) concept, a toroidal MFE concept at a relatively low level of development. The largest FRC device, the Large S Experiment (LSX) was built by Spectrum Technologies, Inc. between 1986 and 1990 at a cost of \$14 million with a planned yearly

operating budget of about \$3 million. Although DOE decided in late 1990 to terminate funding for LSX experiments examining the feasibility of the FRC fusion concept (see below), LSX received partial funding to explore its use as a technology for refueling of tokamaks.<sup>7</sup>

**■ Promote Competition in Research and Development**

Finally, pursuing more than one fusion concept may provide the discipline that comes with competition. Providing a competitor for the tokamak was one of the reasons for supporting the now-abandoned magnetic mirror concept during the 1970s and early 1980s.<sup>8</sup> Similarly, in the late 1980s, then-Energy Secretary Watkins proposed a head-to-head competition between the tokamak and inertial fusion energy (IFE).

**STATUS AND PROSPECTS OF ALTERNATE CONCEPTS**

There are several alternate fusion concepts with a wide range of maturity levels or development of the information base. Over the past decades, the primary focus of the fusion energy program has been on several MFE concepts.<sup>9</sup> Extensive research relevant to IFE has also been performed, largely for its potential defense applications. As a result, many MFE and IFE concepts generally enjoy a far more advanced knowledge base than other fusion concepts such as the colliding beam and inertial electrostatic concepts. Past efforts have been much less extensive both in theory and experiment, and knowledge about the prospects is far more speculative.

The likelihood that some alternate concept may attain and exceed the expected technical and economic performance of the tokamak remains speculative. Developing comparative information judging the relative strengths and weakness of a broad range of alternate concepts and assessing

<sup>7</sup> Alan L. Hoffman, University of Washington, letter to OTA, May 9, 1994.

<sup>8</sup> See, e.g., "Fusion's \$372-Million Mothball," *Science*, vol. 238, Oct. 9, 1987, p. 153.

<sup>9</sup> For a primer on various magnetic confinement fusion concepts, see Office of Technology Assessment, *op. cit.*, footnote 1.

the information base has not been a priority of the fusion energy program. In particular, there is no current, published DOE-sponsored analysis of the comparative technical prospects and challenges of the broad array of fusion concepts including novel ones or those previously examined and no longer pursued. DOE has sponsored and published, however, reviews of alternate MFE concepts that discuss their relative level of development and likely prospects,<sup>10</sup> and has supported some analyses of the relative prospects of IFE.<sup>11</sup> The lack of comparative assessment of non-MFE or IFE concepts is consistent with the fusion energy program's primary focus on MFE concepts rather than a broader array of fusion concepts.

### ■ MFE Concepts

Prior to the 1990s, DOE pursued a variety of MFE concepts that use magnetic fields to control the range of motion of the plasma. This research effort included construction of several small and intermediate facilities to examine such diverse MFE concepts as stellarators, mirrors, reversed field pinch; and FRC. Notably, only the stellarator has come close to attaining the plasma conditions (e.g., confinement times, temperatures, and densities) attained by tokamaks. The lower levels of performance, however, may be due to a lack of follow-through rather than a lack of potential. Many major alternate concept experiments have been either canceled prior to completion of construction, or kept to a limited experimental effort primarily for budgetary reasons rather than poor technical promise. As noted by DOE in its fiscal year (FY) 1993 budget request:

... fiscal constraints have required the program to prematurely narrow its focus to the tokamak concept, including tokamak improvement activities, and to eliminate major alternate magnetic confinement program elements.

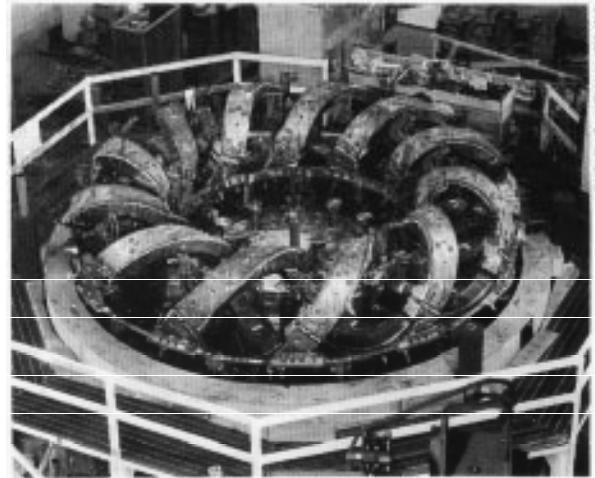

*The Advanced Toroidal Facility Stellarator at Oak Ridge National Laboratory in Tennessee.*

Table 4-4 shows the status of several experimental facilities for alternate magnetic fusion concepts that were under development but were canceled, mothballed, or operated minimally since the mid-1980s. The FRC case provides one example of a technically successful alternate concept with a limited knowledge base that DOE largely discontinued due to budgetary considerations. FRCs have highly complex effects that are not well understood, requiring experimental work to determine the physics of stability and confinement. If the physics turn out to be favorable, however, FRC may present an attractive reactor concept, with high output power densities and the potential for relatively simple engineering compared to the tokamak (e.g., a natural divertor to exhaust reaction products and heat, based on the device's linear geometry). Work on small FRCs at Los Alamos National Laboratory and Spectra Technology, Inc. in the late 1970s and 1980s was promising, leading to a DOE decision to build a larger device--the \$14 million LSX to explore the physics in a regime more relevant to reactors.

<sup>10</sup> For example, see Fusion Energy Advisory Committee, *op. cit.*, footnote 3; and Argonne National Laboratory, Fusion Power Program, "Technical Planning Activity: Final Report," prepared for the U.S. Department of Energy, Office of Fusion Energy, January 1987.

<sup>11</sup> For example, see Fusion Policy Advisory Committee, *op. cit.*, footnote 2.

TABLE 4-4: Major U.S. Alternate MFE Concept Experiments Since the Mid-1980s<sup>1</sup>

Concept	Facility	Construction cost (\$ in millions)	Status
Mirror	MFTF-B	\$372	Closed in 1986, upon completion of construction.
Stellarator	ATF	\$19	Operated intermittently since opening in 1990, mothballed 1994.
Field reversed configuration	LSX	\$14	Operated minimally upon completion in 1992; being relocated since 1993 to be used for tokamak fueling experiments.
Reversed field pinch	CPRF	\$58 (unfinished)	Canceled during construction, 1992.
Reversed field pinch	MST	\$4	Operated at reduced budget since opening in 1988.
Spheromak	MS	\$4	Maryland Spheromak was phased out in 1992 without attaining anticipated performance.
Spheromak	s-I	\$9	Constructed at the Princeton Plasma Physics Laboratory in 1983, operated until 1987, demonstrating some fundamental physics of the concept.

<sup>1</sup>There are a number of alternate concepts that have been pursued in other countries in addition to the U.S. facilities listed here

SOURCE: Office of Technology Assessment, 1995.

However, the anticipated \$3 million annual funding to conduct experiments on the LSX to explore the prospects of FRC for a potential fusion energy device was dropped in 1991, the year after construction was completed. A more limited experimental course was continued at about one-quarter the planned budget, examining the use of the FRC concept for tokamak refueling.

The reversed field pinch (RFP) concept has a limited knowledge base and has been greatly cut back due to budgetary considerations. As with FRC, RFP has physics challenges (primarily, poor energy confinement) requiring experimental work. However, if techniques can be developed to improve confinement, RFP offers some potentially attractive features. A key benefit is that the magnetic field required is about one-tenth that of the tokamak, which could lead to a more compact,

high-power density fusion powerplant. In the early 1990s, DOE canceled construction of a \$75-million RFP device, the ZT-H, that was about 75 percent complete, again for budgetary reasons. A much smaller RFP device, MST, continues partial operation at the University of Wisconsin. Operation of an Italian RFP device called the RFX of similar size to the ZT-H began in 1991.<sup>12</sup>

The largest fusion energy project cancellation is the Mirror Fusion Test Facility-B (MFTF-B), a \$372-million (as spent) alternate concept device that was mothballed due to budget constraints the day after completing construction in 1986, but prior to its commissioning.<sup>13</sup> MFTF-B did face considerable technical challenges identified during the last two years of its construction, as experiments at much smaller mirror facilities gave

<sup>12</sup>Fusion Energy Advisory Committee, op. cit., footnote 3, p. 7.

<sup>13</sup>"Fusion's \$372-Million Mothball," op. cit., footnote 8, pp. 152-155.

disappointing results for the mirror concept generally. MFTF-B would also have been expensive to operate, costing tens of millions of dollars annually. However, as it was never operated, MFTF-B did not provide experimental evidence either supporting or rejecting the mirror concept. As shown in table 4-4, several other major facilities were built during the 1980s to test a variety of alternate concepts, most of which were retired early or pursued a limited course of experimental studies.

Some alternate MFE concepts previously investigated and found less promising than the tokamak may warrant reconsideration, based on improvements in technology and theoretical understanding. For example, one of the major challenges with the stellarator concept was designing and fabricating the relatively intricate magnets required. However, advanced computer-based analytical capabilities continue to improve the ability to design and manufacture magnets. Some of these techniques were developed and used in producing the now prematurely retired Advanced Toroidal Facility (ATF), the most recent stellarator.<sup>14</sup> While the stellarator may not ultimately prove more attractive than the tokamak, improving magnet technology continues to reduce one of its principal drawbacks. Advantages relative to the tokamak include that they are inherently steady state, have no plasma current, and thus do not suffer from disruptions and instabilities of the plasma. The approximately \$1-billion Large Helical Device (LHD), under construction in Japan, is a superconducting stellarator similar to ATF in concept, but closer to TPX in scope and cost. A similar scale stellarator has been proposed in Germany. A much smaller stellarator with a cost of about \$3 million is under construction at the University of Wisconsin as part of DOE's small program for alternate fusion concepts.

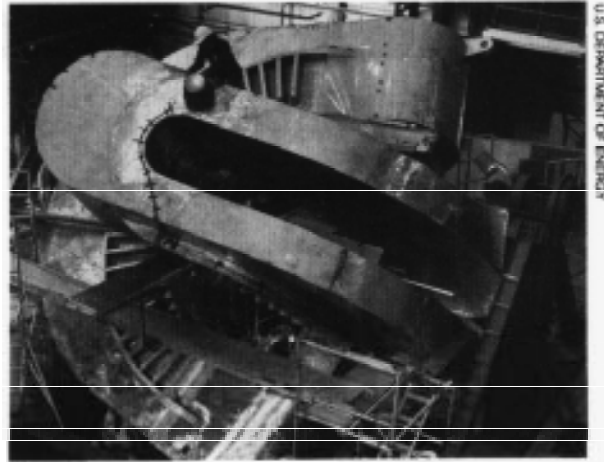

End magnets for the Mirror Fusion Test Facility (MFTF-B)  
Lawrence Livermore National Laboratory

DOE last sponsored a detailed examination of the prospects for tokamaks and alternate magnetic confinement concepts in the mid- 1980s, which resulted in a January 1987 report, "Technical Planning Activity: Final Report" (TPA).<sup>15</sup> While that document remains a useful source of information, there has been considerable change since it was produced. For example, there have been major advances in tokamak performance, some limited experimental efforts on some alternate MFE concepts, and a continuing improvement in the broad base of physics and technology related to fusion. Thus, the TPA does not provide an entirely up-to-date foundation for evaluating the current merits of alternate fusion research efforts. More recently, DOE's FEAC panel on concept improvement (FEAC panel #3) has provided a substantially less detailed review of alternate concepts, which makes note of the advances in MFE.

Reviews of MFE concepts have classified the concepts according to their status or level of development.<sup>16</sup> For example, FEAC panel #3 di-

<sup>14</sup> Following completion of construction in 1988, ATF was held to a limited operational schedule and retired prematurely for budgetary reasons rather than poor technical performance.

<sup>15</sup> Argonne National Laboratory, *op. cit.*, footnote 10.

<sup>16</sup> *Ibid.*; Office of Technology Assessment, *op. cit.*, footnote 1; and Fusion Energy Advisory Committee, *op. cit.*, footnote 3.

TABLE 4-5: Level of Development of Alternate Concepts

<b>FEAC Panel #3-concept improvement</b>	<b>OTA Starpower report</b>
<b>Highly developed concepts</b>	<b>Well-developed knowledge base</b>
Tokamaks	Conventional tokamak
Stellarators	
<b>Developing concepts</b>	<b>Moderately developed knowledge base</b>
Reversed field pinch	Advanced tokamak
Field reversed configuration	Tandem mirror
	Stellarator
	Reversed field pinch
<b>Small scale innovative concepts</b>	<b>Developing knowledge base</b>
Unspecified	Spheromak
	Field reversed configuration
	Dense Z-pinch

SOURCES: Fusion Energy Advisory Committee, *Advice and Recommendations to the Department of Energy in Partial Response to the Charge Letter of September 24, 1997: Part D*, DOE/ER-0555T (Washington, DC: U.S. Department of Energy, Office of Energy Research, 1992), p 11, and U.S. Congress, Office of Technology Assessment, *Starpower: The U.S. and the International Quest for Fusion Energy*, OTA-E-336 (Washington, DC: U.S. Government Printing Office, October 1987), table 1-1, p. 12.

viald MFE concepts into three categories of development, as shown in table 4-5. The panel did not explicitly investigate the prospects for potential fusion powerplants, but rather commented on the current state of scientific understanding of alternate concepts. Similarly, OTA's 1987 *Starpower* report included a listing of magnetic confinement concepts then under investigation in the United States, and their level of development based on DOE's TPA. The lists of concepts in the earlier documents (i.e., OTA and TPA) are longer, reflecting the greater variety of alternate MFE concept research then being pursued.

## ■ IFE Concepts

Considerable effort has been devoted to understanding inertial confinement, in which a pellet of

fusion fuel is heated and compressed by intense lasers or heavy-ion drivers to such high densities that the fuel's own inertia is sufficient to contain it for the very short time needed for fusion to occur (see figure 4-1). Numerous reviews have concluded that the IFE concept using a heavy-ion driver is a promising approach to an eventual fusion powerplant.<sup>17</sup> DOE has sponsored reactor studies of conceptual designs of IFE powerplants.<sup>18</sup> There is, however, considerable scientific and technical uncertainty with IFE. Overall, IFE proponents envision a \$4-billion civilian effort (supplemented with about \$4 billion in DOE Defense Program research) over the next 30 years involving several new facilities to address the scientific and technical challenges, culminating in a demonstration powerplant. Although much

<sup>17</sup> FFAC Panel #7 Report, "Inertial Fusion Energy," in U.S. Department of Energy Fusion Energy Advisory Committee, *Advice and Recommendations to the U.S. DOE in Response to the Charge Letter of Sept. 18, 1992* (Washington, DC: June 1993); and Fusion Policy Advisory Committee, op. cit., footnote 2.

<sup>18</sup> See, e.g., R.W. Moir et al., "HYLIFE-II: A Molten-Salt Inertial Fusion Energy Power Plant Design-Final Report," *Fusion Technology*, vol. 25, January 1994, pp. 5-25.

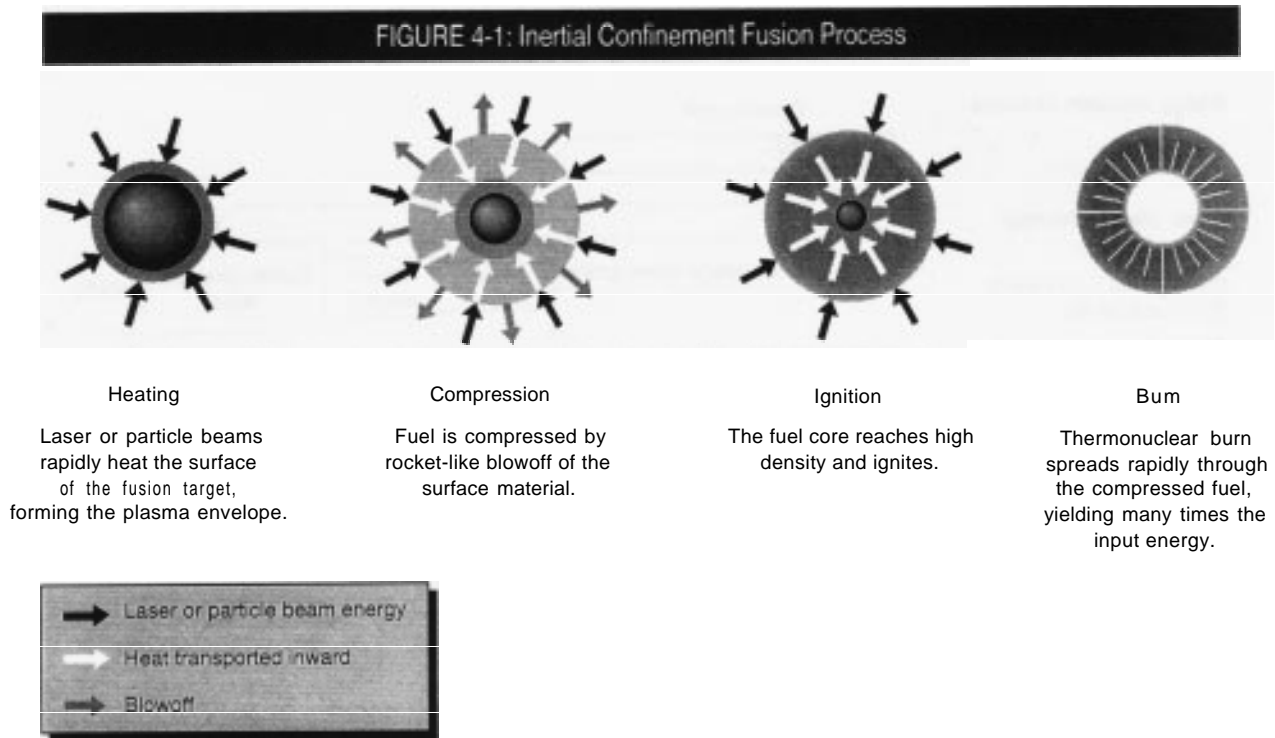

SOURCE: Lawrence Livermore National Laboratory.

scientific and technical work remains to be done (see figure 4-2), the information base for IFE is moderately well established, as are the next research and development steps.<sup>19</sup>

Inertial confinement research mimics, on a very small scale, some processes in the hydrogen bomb, and most of the research relevant to IFE has been performed by DOE's Office of Defense Programs for its applications to nuclear weapons and stockpile stewardship responsibilities. The scientific feasibility of achieving high gain in an inertial confinement fusion target has been demonstrated in underground nuclear explosion experiments at the Nevada Test Site in a program called Halite/Centurion. The next step in examining the science of target physics and ignition depends on the National Ignition Facility (NIF),

another effort planned for the DOE Defense Program. NIF is a proposed \$1-billion research facility being considered as part of the stockpile stewardship program to maintain expertise for nuclear weapons. The scientific results that NIF or something like it would produce are essential to demonstrating ignition and propagating burn of high-gain targets, and to establishing the requirements that an IFE driver would have to meet. However, whether NIF is pursued will depend more on weapons-related reasons, including its role in stockpile stewardship and the potential effects on weapons proliferation rather than its benefits for the fusion energy program. DOE announced plans to proceed with NIF in October 1994, but is also performing a detailed study of the

<sup>19</sup>See, e.g., B. Grant Logan et al., "The Inertial Confinement Fusion Pathway," paper presented at the Forum on Pathways to Fusion Power, American Nuclear Society Annual Meeting and Fusion Topical, New Orleans, LA, June 22, 1994.

FIGURE 4-2: One Proposed U.S. Inertial Fusion Strategy

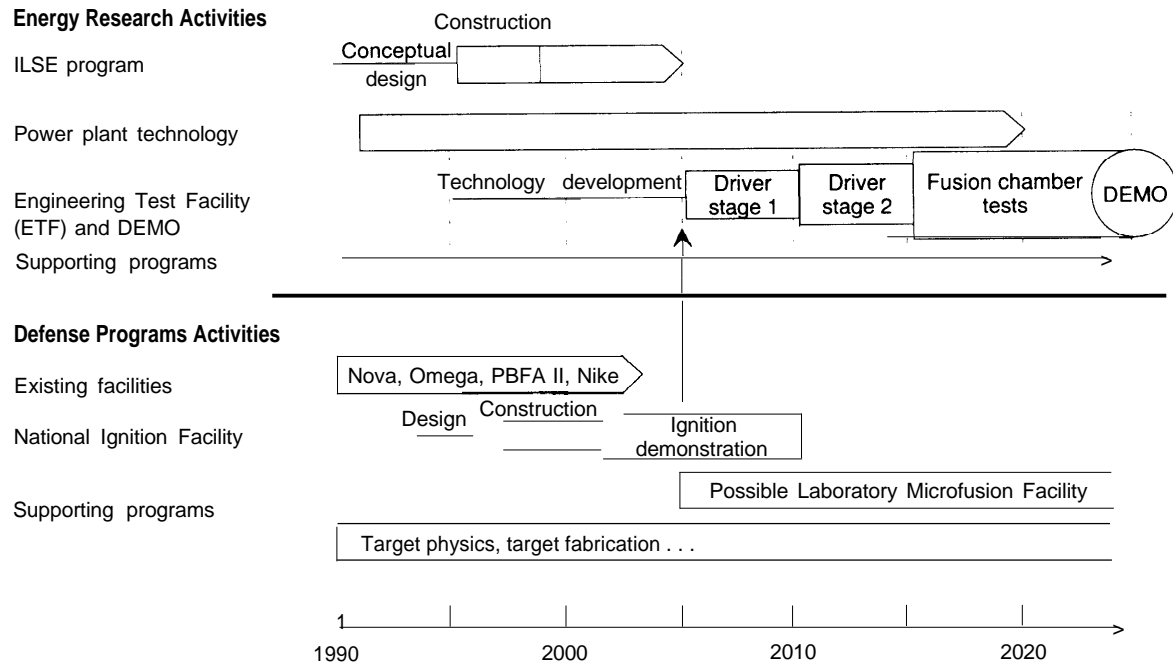

SOURCE: Roger O Bangerter, Head, Fusion Energy Research Program, Lawrence Berkeley Laboratory, "Heavy Ion Inertial Fusion," testimony at hearings before the House Committee on Science, Space, and Technology, Subcommittee on Energy, Aug. 2, 1994

effects of the program on nuclear nonproliferation, expected to be completed in 1995.

There are important scientific and technical challenges for IFE that go beyond the target physics research needs shared with the Defense Program. The most important of these is development of a driver that is both efficient and can be operated at a high repetition rate (e.g., several times per second) for use in an eventual IFE powerplant. In contrast, while lasers can be highly effective for target physics research, which requires a repetition rate of one burst every several hours, they lack the efficiency and repetition rate needed by IFE powerplant drivers. Numerous reviews have supported development of a heavy-ion driver, which is the most advanced concept. The heavy-ion driver concept builds on the considerable investment

in science and technology developed for the accelerators used in high-energy physics. The next step in heavy-ion driver development is called the Induction Linac Systems Experiments (ILSE), with an estimated construction cost of about \$50 million. While heavy-ion drivers appear to be the most advanced concepts for IFE, there are other approaches that may eventually prove attractive as well, including light-ion drivers and advanced lasers.<sup>20</sup>

Budget constraints have caused a continued deferral in the development of key research efforts for IFE, including ILSE. Despite favorable recommendations from review committees for proceeding with ILSE, the IFE budget was reduced from \$9 million in FY 1992 to \$4 million in FY

<sup>20</sup> Charles D. Orth et al., Lawrence Livermore National Laboratory, "Diode-Pumped Solid-State-Laser Driver for Inertial Fusion Energy Power Plants," *ICF Quarterly Report*, vol. 3, No. 4, July-September 1993, pp. 145-154.



1993. In commenting on the lack of progress in the IFE effort, one review body found the following:

The Department of Energy has not established an IFE program that resembles remotely the one envisioned by FPAC. Ostensibly this has been due to stringent funding allocations for fusion as a whole.<sup>21</sup>

In general, IFE proponents suggest a development path with inherently less dependence on extremely expensive individual facilities than the tokamak by virtue of greater modularity in experimental facilities. For example, while an ignition facility is an expensive component of an IFE development path, that one facility could service the research needs of several drivers. An overview of the research needs for IFE development and a simplified development path as developed by proponents is shown in figure 4-1. In total, IFE proponents project budget needs of about \$4 billion over the next three decades to develop a demonstration powerplant (DEMO).<sup>22</sup> This cost estimate includes neither the anticipated \$1.8 billion to build and operate NIF, nor other efforts paid for under DOE's Defense Program. Counting all defense research also relevant to IFE would add about \$4 billion to the costs. Further, it must be noted that the cost estimates are highly uncertain, and depend on such unresolved physics issues as the gain achievable with a given driver.

### ■ Other Novel Concepts

A number of novel fusion energy concepts have been suggested that take fundamentally different approaches from those used in either MFE or IFE.<sup>23</sup> Relative to inertial and magnetic confinement fusion, these approaches have generally re-

ceived very limited attention in the fusion energy program, and are at an embryonic development stage, with far less well understood and demonstrated scientific concepts. While the lack of scientific understanding and demonstration can be a notable shortcoming of novel concepts, some proponents find this to be the essence of their potential benefit and justification for support. For example, one physicist long associated with certain novel concepts notes:

If there is a route to dramatically more attractive fusion systems, it will be in the investigation of new or relatively unexplained physics rather than in engineering refinements of present or recently terminated programs.<sup>24</sup>

Just as the scientific aspects can be highly speculative, the broader technology issues that would have to be addressed leading to a fusion energy powerplant based on any of these concepts have typically not been examined in detail. However, proponents of these concepts suggest a variety of possible advantages relative to the tokamak, ranging from ability to use advanced fuels (e.g., helium-3 and deuterium, which produces less neutron radiation than results from the deuterium-tritium reactions of tokamak and IFE) to smaller, more flexible powerplant sizes, to lower construction and operating costs. As noted earlier, DOE has not published an analysis of the comparative technical prospects and challenges of novel alternate concepts.

One example of the many novel concepts is muon catalysis, which involves using a subatomic particle called a muon to shield the electric charge of one of the nuclei in a fusion reaction from the other. This shielding mitigates the repulsive forces

<sup>21</sup> FEAC Panel #7 Report, op. cit., footnote 17.

<sup>22</sup> Donald Correll, Deputy Program Leader, Laser Programs—Inertial Confinement Fusion Lawrence Livermore National Laboratory, fax to OTA, July 22, 1994; and Roger O. Bangert, Lawrence Berkeley Laboratory, "Heavy Ion Inertial Fusion" testimony at hearings before the House Committee on Science, Space, and Technology, Subcommittee on Energy, Aug. 2, 1994.

<sup>23</sup> For brief descriptors of a number of novel concepts, see for example, Global Foundation, Inc., "1st International Symposium on Evaluation of Current Trends in Fusion Research: Book of Abstracts," Washington, DC, Nov. 14-18, 1994.

<sup>24</sup> Normal Rostoker, "Alternate Fusion Concepts," paper presented at the 1st International Symposium: Evaluation of Current Trends in Fusion Research, Washington, DC, Nov. 14-18, 1994.

and allows the nuclei to approach closely enough to fuse without the need for extreme temperature. Muon-catalyzed fusion reactions have been observed in high-energy physics experiments dating back several decades, although the number of fusion reactions produced per muon before it decays was lower than would be necessary to make the process worthwhile.

Inertial electrostatic confinement fusion is a more developed, but still novel approach that has received limited attention from the fusion energy program. The concept involves confining the highest energy fuel ions electrostatically, leading to greater reactivity than found in an MFE plasma. While some work has been performed examining the scientific basis of the concept including at the University of Wisconsin and the University of Illinois, the theoretical studies remain at a relatively preliminary stage. A related concept, the colliding beam, was largely discarded decades ago based on theoretical and experimental results using the migma reactor approach that indicated an inability to develop a sufficient ion density. However, proponents of the concept suggest that developments in the field of high-energy physics and in the accompanying technology of linear accelerators may provide solutions to this drawback of the colliding beam concept.<sup>25</sup>

Perhaps the most widely debated and controversial novel concept has been cold fusion. In 1989, two researchers, Stanley Pons and Martin Fleischmann, announced that they had discovered a method of producing nuclear fusion at room temperature using a simple electrochemical apparatus. Although some researchers reported results supporting the claims, many of those findings were subsequently retracted or could not be confirmed by other researchers. A 1989 DOE advisory committee of nuclear physicists and chemists concluded that “evidence for the discovery of a

new nuclear process termed cold fusion is not persuasive.”<sup>26</sup> Today, a handful of researchers continue to report that electrolysis of heavy water can lead to the production of excess power. Some investigators theorize that unusual and unexplained chemical or nuclear processes may in fact be at work. The inability to routinely reproduce experimental findings has proven to be a continuing challenge, and the results are still questioned by a majority of the scientific community. However, the Japanese agency MITI has an ongoing program examining the phenomena, with funding of about \$5 million in 1994.<sup>27</sup>

## STEPS IN EXAMINING ALTERNATE CONCEPTS

The next step that would be required in development of any alternate concept depends on its level of maturity. While immature concepts may be well suited to a great deal of relatively inexpensive theoretical analysis for screening purposes, some such as IFE are at a point where major facilities such as ILSE and NIF are required to continue development.

Theoretical research, modeling, and analysis can be useful tools for examining the likely merits of an alternate concept. These theoretical efforts can include a wide range of expertise from detailed physics (e.g., modeling of radiation/magneto-hydrodynamics for high-density plasmas; modeling of particle orbits and collisional effects) to reactor design and economic analysis assuming favorable physics (e.g., commercial reactor evaluations and systems modeling<sup>28</sup>). Computational abilities continue to improve, making theoretical studies increasingly feasible. Even for relatively more advanced concepts, theoretical analysis can be useful for estimating the potential long-term attractiveness, and thus

<sup>25</sup> B.C. Maglich et al., “Modern Magnetic Fusion,” Advanced Physics Corp. Report # SAFE-94-104, May 5, 1994.

<sup>26</sup> Energy Research Advisory Board, “Cold Fusion Research,” a report to the U.S. Department of Energy, November 1989.

<sup>27</sup> *Nature*, vol. 367, Feb. 24, 1994, p. 670.

<sup>28</sup> These include, for example, the ARIES series of studies for tokamaks and HYLIFE-II for heavy-ion inertial fusion.

help set priorities for the next, more costly experimental steps.

One team of fusion researchers at Lawrence Livermore National Laboratory (LLNL) has proposed an “Advanced Fusion Assessment Program” intended to perform objective evaluation and development of alternate concepts. They intend for the effort to become an effective tool for DOE in managing the longer term fusion program, by taking good ideas far enough that DOE can choose an appropriate organization to pursue an experimental program.<sup>29</sup> As envisioned by the LLNL team, this program would encompass the following:

- Seek out good ideas for fusion systems that offer improvements over present concepts that approach an order-of-magnitude.
- Build appropriate teams of LLNL, U.S. scientists, and U.S. industry to evaluate both the physics *and* reactor potential. Make scientific and engineering evaluation tools available to people with new ideas.
- Provide neutral, objective evaluation rather than advocacy of specific ideas.
- Provide physics support as needed as such programs get underway.

The LLNL proposal emphasizes theoretical, rather than experimental, studies. These would be integrated studies, including a full range of analysis from basic physics to examining the likely reactor characteristics and economics, assuming the physics is found promising after experimental efforts. The effort could be useful as an integrated screening tool and may be able to sort out the truly promising but undeveloped concepts from less promising ones. According to LLNL team members, an initial evaluation of an undeveloped concept, including basic physics and reactor potential, could be performed for a few hundred thousand dollars. A full theoretical, computational, and reactor potential study would probably require a few million dollars.<sup>30</sup> Overall, the LLNL

proposal suggests a one-year budget of about \$3.5 million, or less than one percent of the fusion energy program budget.

Understanding, evaluating, and developing a fusion concept cannot be accomplished with theoretical work alone, however. In some areas of fusion physics, theory and modeling capabilities are not currently adequate for exploring fusion energy concepts. For example, existing theoretical tools are better suited to analyzing high-density plasmas than low-density plasmas such as tokamak. Thus, for alternate concepts involving low-density plasmas, experimental devices are essential for examining the physics prospects. Even in those cases for which analytical capabilities are well suited, the complexity of the physics and technology requires extensive experimental work as a concept is developed to validate the predictions of theory. The evolution of scientific and technological understanding has typically proceeded in stages using increasingly capable, and often larger, facilities. This evolution builds on the empirical results from operation of previous facilities, extrapolating the existing knowledge base to design a more capable facility.

The necessary dependence on experimental facilities and research to verify theory can make concept development expensive. One aspect of the reliance on empirical results is that advanced studies require increasingly capable and expensive facilities as a concept is developed, which can lead to substantial budget requirements. However, examination of a wide range of alternate concepts does not necessarily entail an extensive series of facilities reaching into several billions of dollars. There are two main reasons: first, as information is gained about a concept during earlier stages of development, only some will be found to merit promotion to subsequent stages of development. Criteria for promoting a concept to a subsequent stage (and development of more and costlier experimental facilities) may include development

<sup>29</sup> R. Paul Drake et al., Lawrence Livermore National Laboratory, “Advanced Fusion Assessment,” Aug. 19, 1994.

<sup>30</sup> D.E. Baldwin and John Perkins, personal communications, Aug. 11, 1994 and Nov. 17, 1994.

cost, likelihood of technical success, and likelihood that the concept, if successful, will provide a substantial cost or performance advantage over the tokamak. Budgetary considerations can also be an important criterion for determining whether the prospects of a concept justify the additional spending for further development work.

Second, while tokamak development has involved a series of larger, more capable, and more expensive facilities reaching on the order of \$10 billion, some alternate concepts may not require as extensive a succession. For example, a concept with inherently higher power densities such as FRC, if found to be technically promising based on theoretical reviews and small experimental efforts, may require smaller and less costly facilities relative to the tokamak. While pursuing FRC would still require a series of theoretical and experimental efforts, including development of larger facilities if current results so warrant, its proponents suggest that an engineering test reactor could be far smaller and less costly than ITER.<sup>31</sup> As noted in the previous section, IFE provides another example of a potentially less costly and more flexible development path for a fusion powerplant.

### DOE'S PROGRAM FOR ALTERNATE CONCEPTS

In the Energy Policy Act of 1992 (EPACT), Congress set a goal for DOE of pursuing a broad-based fusion energy program that would, by 2010, verify the practicability of commercial electric power production. EPACT further directed the department to develop a comprehensive plan for the program that would “include specific program objectives, milestones and schedules for technology development, and cost estimates and program

management resource requirements.”<sup>32</sup> However, DOE has not yet developed that overall plan. Nor has it explicitly examined and justified a level of effort and a process for identifying, evaluating, and, where appropriate, pursuing alternate concepts, which arguably are one aspect of a broad-based fusion energy program. That is, there is no explicit DOE analysis of the relationship between alternate concepts and the overall fusion energy program objective—developing a technically and economically attractive method of electric power production.

Although DOE has not published a strategic plan for the fusion energy program, it has pursued a course of greatly reducing emphasis on alternate concepts in the past several years. With substantial cutbacks in alternate concept work in the past several years, many fusion researchers (including those not identified with any particular alternate concept) perceived indifference or worse on the part of DOE for alternate concepts. The FEAC panel #3 on concept improvement noted the following:

. . . statements and communications by the Department [of Energy] led to the perception in the fusion community that proposals for research on non-tokamak concepts would not be supported by OFE, and should not be submitted. . . . The rationale given was that research on competing concepts could not be supported, since, even if the research were successful, no funds would be available to develop the concept to its next, more expensive state; thus it would be best not to begin.<sup>33</sup>

Similarly, LLNL researchers have recently noted: “There is now little focus on seeking, generating, and objectively examining advanced ideas” and “in fact, the current environment is rather hostile

<sup>31</sup> Hoffman, *op. cit.*, footnote 7.

<sup>32</sup> Energy Policy Act of 1992, Public Law 102-486, Oct. 24, 1992, Sec. 2114.

<sup>33</sup> FEAC Panel #3, “Concept Improvement: A Report to the Fusion Energy Advisory Committee,” May 11, 1992, p. 2, in Fusion Energy Advisory Committee, *op. cit.*, footnote 3, app. I.

to new ideas for fusion and inventors have trouble finding support.”<sup>34</sup>

In 1992, FEAC recommended “that a small but formal and highly visible periodic competition be established to foster new concepts and ideas that if verified would make a significant improvement in the attractiveness of fusion reactors.”<sup>35</sup> In response, DOE announced an “Innovative Concepts Initiative” and a request for proposals “to support innovations in tokamak improvements and new fusion confinement systems.”<sup>36</sup> The announcement anticipated awarding a total of \$1 million to be divided among no more than three grants. DOE judged 15 of the 24 applications to be eligible and provided those to a non-DOE peer review committee. A total of \$1.2 million annually in fiscal years 1993 through 1995 was provided to the three winning applicants. Among these was a concept closely related to FRC, called the Ion Ring.

The current level of effort devoted to alternate concepts is widely viewed as inadequate relative to the overall fusion energy program. While pursuit of alternate concepts is widely agreed on by fusion proponents as one aspect of a balanced fusion energy program, the appropriate level of effort devoted to alternate concepts is less clear. In FY 1994, about \$1.2 million, less than 1/2 percent of the total fusion energy budget, was dedicated to the Innovative Concepts Initiative. About \$4 million was devoted to inertial fusion energy, the most developed and promising alternate concept, an amount insufficient to proceed to the next development step, a heavy-ion driver experiment. In fact, FEAC had in 1993 reported to DOE that “there is no credible program for the development

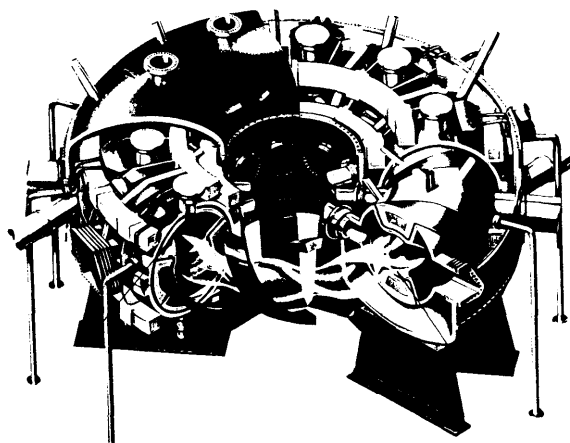

JAPAN MINISTRY OF EDUCATION

*The Large Helical Device (a stellarator) under construction in Japan is estimated to cost about \$1 billion.*

of a heavy-ion fusion energy option” at an annual funding rate of \$5 million.<sup>37</sup>

DOE suggests that a “healthy, but constrained” alternate concepts program would require about \$100 million per year.<sup>38</sup> However, a substantial amount of information could be developed with a far more modest program that provides a freer basis for making future alternate concept decisions. For example, pursuing an advanced fusion assessment proposal of the type suggested by LLNL researchers, supporting the civilian portion of the IFE budget, repeating the DOE Innovative Concepts Initiative, and restarting or accelerating confinement concept experiments at existing but underused or idled facilities such as LSX and the ATF stellarator could cost under \$20 million or about five percent of the current fusion energy program budget. Increased international collabo-

<sup>34</sup>Perkins et al., op. cit., footnote 5.

<sup>35</sup>Fusion Energy Advisory Committee, Op. Cit., footnote 3, p. 11.

<sup>36</sup>*Federal Register*, vol. 57, No. 244, Dec. 18, 1992, pp. 60197-60198.

<sup>37</sup>U.S. Department of Energy, Fusion Energy Advisory Committee, *Advice and Recommendations to the Department of Energy in Partial Response to the Charge Letter of September 18, 1992*, DOWER-0594T (Washington, DC: June 1993), p. 11.

<sup>38</sup>U.S. Department of Energy, “Fusion Energy Program,” briefing package presented by N. Anne Davies to OTA, Apr. 28, 1994.

ration making use of existing alternate concept research facilities in other countries may also be a lower cost alternative to sole U.S. funding of new intermediate-scale facilities.

## **CONCLUSION**

In summary, while alternate concepts provide no panacea for fusion energy development, there is merit in examining them as part of a broad fusion program. Relative to the expected costs of the tokamak effort, a great deal of exploratory work can

be conducted at modest cost. Assuming some of the concepts prove technically promising, however, further development may require larger budgets for construction of expensive facilities. As with the tokamak effort, the potential role of the overall fusion energy program in meeting long-term energy needs, and the level of research effort justified by that potential role, are critical issues for the direction of alternate concepts research.

# Appendix A: Acronyms and Glossary of Terms

# A

## ACRONYMS

AEC	Atomic Energy Commission	FMIT	Fusion Materials Irradiation Test Facility
ATF	Advanced Toroidal Facility, Oak Ridge, Tennessee	FPAC	Fusion Policy Advisory Committee
BPX	Burning Plasma Experiment	FRC	field reversed configuration
CDA	conceptual design activity	ICF	inertial confinement fusion
CIT	Compact Ignition Tokamak, proposed for Princeton Plasma Physics Laboratory, Princeton, NJ	IFE	inertial fusion energy
CPMP	Comprehensive Program Management Plan	ILSE	Induction Linac System Experiments
DIII-D	Double III upgrade, General Atomics, San Diego	ITER	International Thermonuclear Experimental Reactor
D-D Reaction	deuterium-deuterium fusion reaction	JET	Joint European Torus
DEMO	Demonstration Fusion Powerplant	JT-60 super upgrade	Japan Tokamak 60 super upgrade
DOE	U.S. Department of Energy	JT-60U	Japan Tokamak 60 upgrade
D-T Reaction	deuterium-tritium fusion reaction	LBL	Lawrence Berkeley National Laboratory, Berkeley, CA
EDA	engineering design activity	LHD	Large Helical Device
EPACT	Energy Policy Act of 1992	LLNL	Lawrence Livermore National Laboratory, Livermore, CA
ERAB	Energy Research Advisory Board	LSX	Large S Experiment
ETR	engineering test reactor	MeV	million electron volts
FEAC	Fusion Energy Advisory Committee	MFAC	Magnetic Fusion Advisory Committee
		MFE	magnetic fusion energy

MFEEA	Magnetic Fusion Energy Engineering Act of 1980	PCAST	President's Council of Advisors on Science and Technology
MFPP	Magnetic Fusion Program Plan	PPPL	Princeton Plasma Physics Laboratory, Princeton, NJ
MFTF-B	Mirror Fusion Test Facility B	Q	Energy gain
MW	megawatts	RFP	reversed field pinch
NAS	National Academy of Sciences	R&D	research and development
NES	National Energy Strategy	SSAT	steady-state advanced tokamak
NIF	National Ignition Facility	SEAB	Secretary of Energy Advisory Board
OFE	Office of Fusion Energy	T-15	large superconducting tokamak, Kurchatov Institute, Russia
ORNL	Oak Ridge National Laboratory, Oak Ridge, TN	TFTR	Tokamak Fusion Test Reactor
PBX-M	Princeton Beta Experiment-Modification	TPX	Tokamak Physics Experiment

## GLOSSARY

**Advanced fuel cycles:** The use of fuels other than D-T to sustain fusion reactions. Alternate fuel cycles include enhanced D-D reactions, reactions of deuterium with helium-3 ( $D-^3\text{He}$ ), or lithium-6 ( $D-^6\text{Li}$ ), and proton-Boron-11 ( $p-^{11}\text{B}$ ) reactions. Achieving fusion with these fuels would typically require higher temperatures and Lawson confinement parameters than required for D-T fuels as well as substantial improvements in available plasma technologies. The attraction of these fuel cycles is that they require little or no tritium, and produce fewer and lower energy neutrons thus reducing radiation damage, allowing the use of existing materials and minimizing radioactive wastes.

**Advanced tokamak:** A tokamak incorporating features such as steady-state current drive or shaping of the plasma in order to attain higher performance or more efficient operation than the conventional tokamak. See “Tokamak” or “Conventional tokamak.”

**Alpha particle:** A positively charged particle, identical to a helium-4 nucleus, composed of two protons and two neutrons. An alpha particle is emitted in the radioactive decay of many naturally occurring radioisotopes such as uranium and thorium; it is also one of the products of the D-T fusion reaction.

**Alpha particle heating:** Heating of a fusion plasma by alpha particles generated during the fusion reaction colliding with deuterium and tritium

in the plasma. Alpha particle heating is expected to be the principal source of heating in a D-T fusion plasma once ignition is achieved.

**Alternate concept or alternate confinement concept:** As used in this report, a nontokamak confinement concept.

**Ash:** An end product of a fusion reaction. For the D-T fusion reaction, the “ash” is helium gas.

**Auxiliary heating:** External systems that heat plasmas to higher temperatures than can be reached from the heat generated by electric currents within the plasma. Neutral beam heating and radiofrequency heating are both examples of auxiliary heating systems.

**Beta:** The ratio of the outward pressure exerted by the plasma to the inward pressure that the magnetic confining field is capable of exerting. Beta is equivalent to the ratio of the energy density of particles in the plasma to the energy density of the confining magnetic fields.

**Blanket:** Structure surrounding the plasma in a fusion reactor within which the fusion-produced neutrons are slowed down, heat is transferred to a primary coolant, and tritium is bred from lithium.

**Blanket test facility:** A plasma-based large volume neutron source device to be used for the testing of blanket components and materials needed to recover the heat of fusion reactions and to produce new tritium fuel. The need for construction of a separate blanket test facility is dependent



on the timing and scope of the ITER blanket test program.

**Bootstrap current:** A plasma current driven by the plasma itself.

**Breakeven:** The point at which the fusion power generated in a plasma equals the amount of heating power that must be added to the plasma to sustain its temperature.

**Breakeven-equivalent:** Attainment in a non-tritium-containing plasma of conditions (temperature, density, and confinement time) that would result in breakeven if the plasma contained tritium. Because plasmas not containing tritium are far less reactive than those containing tritium, the actual amount of fusion power generated by a breakeven-equivalent plasma will be far less than would be produced under actual breakeven conditions.

**Burning plasma:** A plasma in which the fusion reactions supply a significant fraction of the energy needed to sustain the plasma.

**Celsius:** Centigrade.

**Centigrade:** A thermometric scale on which the interval between the freezing point of water and the boiling point of water is divided into 100 degrees with 0° representing the freezing point and 100° representing the boiling point.

**Conceptual design:** The basic or fundamental design of a fusion reactor or experiment that sketches out device characteristics, geometry, and operating features but is not at the level of detail that would permit construction.

**Confinement:** Restraint of plasma within a designated volume. In magnetic confinement, this restraint is accomplished with magnetic fields.

**Confinement concept:** An approach to controlling the range of motion of a plasma. Due to the extremely high temperatures needed to allow fusion to occur, no solid container can confine a fusion energy plasma. Instead, a variety of approaches, such as using magnetic fields or inertia to confine the plasma can be used.

**Confinement parameter:** The product of plasma density and confinement time that, along with temperature, determines the ratio between power produced by the plasma and power input to the plasma. Also called “Lawson parameter.”

**Confinement time:** A measure of how well the heat in a plasma is retained. The confinement time of a plasma is the length of time it would take the plasma to cool down to a certain fraction of its initial temperature if no heat were added.

**Conventional tokamak:** A tokamak device not incorporating advanced steady-state current drive or plasma shaping technology. See “Tokamak,” “Advanced tokamak.”

**Current drive:** A technique for making the toroidal plasma current using RF or neutral beam power, i.e., without the use of an inductive transformer.

**D-D reaction:** A fusion reaction in which one nucleus of deuterium fuses with another. Two different outcomes are possible: a proton plus a tritium nucleus, or a neutron plus a helium-3 nucleus.

**D-T reaction:** A fusion reaction in which a nucleus of deuterium fuses with a nucleus of tritium, forming an alpha particle and a neutron and releasing 17.6 million electron volts of energy. The D-T reaction is the most reactive fusion reaction.

**Decommissioning:** The steps taken to render a plant, particularly a nuclear reactor, safe to the environment at the end of its operating lifetime.

**Density:** Amount per unit volume. By itself, the term “density” often refers to particle density, or the number of particles per unit volume. However, other quantities such as energy density or power density (energy or power per unit volume, respectively) can also be defined.

**Deuterium (D or  $^2\text{H}$ ):** A naturally occurring isotope of hydrogen containing one proton and one neutron in its nucleus. Approximately one out of 6,700 atoms of hydrogen in nature is deuterium. Deuterium is one of the fuels (along with tritium) needed for the D-T fusion reaction, the most reactive fusion reaction.

**Diagnostics:** The procedure of determining (diagnosing) exactly what is happening inside an experimental device during an experiment. Also, the instruments used for diagnosing.

**Divertor:** A component of a toroidal fusion device used to shape the magnetic field near the plasma edge so that particles at the edge are diverted

away from the rest of the plasma. These particles are swept into a separate chamber where they strike a barrier, become neutralized, and are pumped away. In this way, energetic particles near the plasma edge are captured before they can strike the walls of the main discharge chamber and generate secondary particles that would contaminate and cool the plasma.

**Driver:** A machine that provides the energy to heat and compress an inertially confined fusion target in the form of intense, high-power beams of laser light or particles.

**Electron:** An elementary particle with a unit negative electrical charge and a mass 1/1837 that of a proton. In an atom, electrons surround the positively charged nucleus and determine the atom's chemical properties.

**Electron volt (eV):** A unit of energy equal to the energy that can be acquired by a singly charged particle (e.g., an electron) from a one-volt battery. Since the temperature of a system is proportional to the average energy of each particle in the system, temperature is also measured in electron volts.

**Energy gain (Q):** The ratio of the fusion power produced by a plasma to the amount of power that must be added to the plasma to sustain its temperature.

**Engineering feasibility:** The ability to design and construct all the components, systems, and subsystems required for a fusion reactor.

**Engineering test reactor:** A next-generation fusion experiment to study the physics of long-pulse ignited plasmas, provide opportunities to develop and test reactor blanket components under actual fusion conditions, and integrate the various systems of a fusion reactor.

**Equivalent Q:** For a plasma not containing tritium, a measure of what Q would have been in a tritium-containing plasma that attained the same temperature and confinement parameter. See "Confinement parameter."

**Field-reversed configuration (FRC):** A magnetic confinement concept with no toroidal field, in which the plasma is essentially cylindrical in shape. The FRC is a form of compact toroid.

**Fission:** The process by which a neutron strikes a nucleus and splits it into fragments. Dur-

ing the process of nuclear fission, several neutrons are emitted at high speed, and heat and radiation are released.

**Flux:** The amount of a quantity (e.g., heat, neutrons) passing through a given area per unit time.

**Fusion:** The process by which the nuclei of light elements combine, or fuse, to form heavier nuclei, releasing energy.

**Fusion nuclear technology:** The engineering systems needed to fuel, maintain, and recover energy from a fusion reactor.

**Fusion self-heating:** Heat produced within a plasma from fusion reactions. Since alpha particles produced in fusion reactions remain trapped within the plasma, they contribute to self-heating by transferring their energy to other plasma particles in collisions. Fusion-produced neutrons, on the other hand, escape from the plasma without reacting further and do not contribute to self-heating.

**Heavy ion:** An ion of high mass (e.g., an electrically charged atom of an element from the middle to the high end of the periodic table).

**High-energy gain:** A fusion reaction producing many (10 or so) times as much power as must be input to the reaction to maintain its temperature.

**Hydrogen (H):** The lightest element. All hydrogen atoms have nuclei containing a single proton and have a single electron orbiting that nucleus. Three isotopes of hydrogen exist, having 0, 1, or 2 neutrons in their nuclei in addition to the proton. The term hydrogen is also used to refer to the most common isotope, technically called "protium," that has no neutrons in its nucleus.

**Ignition:** The point at which a fusion reaction becomes self-sustaining. At ignition, fusion self-heating is sufficient to compensate for all energy losses; external sources of heating power are no longer necessary to sustain the reaction.

**Impurities:** Atoms present in a plasma that are heavier than fusion fuel atoms. Impurities are undesirable because they dilute the fuel and because they increase the rate at which the plasma's energy is radiated out of the plasma.

**Inertia:** Inertia is the property of an object to resist external forces that would change its mo-

tion. Unless acted on by external forces, an object at rest will remain at rest, and an object moving in a straight line at constant speed will continue to do so. Under the influence of external forces, objects with differing inertias will respond at different rates.

**Inertial confinement:** An approach to fusion in which intense beams of light or particles are used to compress and heat tiny pellets of fusion fuel so rapidly that fusion reactions occur before the pellet has a chance to expand. The pellet's own inertia, or its initial resistance to expansion even when it is being blown apart, holds the pellet together long enough for fusion energy to be produced.

**Instabilities:** Small disturbances that become amplified, or become more intense, once they begin. A cone balanced upside-down on its tip is subject to an instability, since once it begins to wobble, it will become more unbalanced until it falls over. A stable system, on the other hand, responds to disturbances by opposing them. Small disturbances in a stable system decrease in intensity until they die away. If a ball sitting in the bottom of a bowl is disturbed, for example, it will eventually come to rest again at the bottom of the bowl.

**Ion:** An atom (or molecularly bound group of atoms) that has become electrically charged as a result of gaining or losing one or more orbital electrons. A completely ionized atom is one stripped of all its electrons.

**Isotope:** Different forms of the same chemical element whose atoms differ in the number of neutrons in the nucleus. (All isotopes of an element have the same number of protons in the nucleus and the same number of electrons orbiting the nucleus.) Isotopes of the same element have very similar chemical properties and are difficult to separate by chemical means. However, they can have quite different nuclear properties.

**Laser fusion:** A form of inertial confinement fusion in which a small pellet of fuel material is compressed and heated by a burst of laser light. See "Inertial confinement."

**Lawson parameter:** See "Confinement parameter."

**Light ion:** An ion of low mass, typically an electrically charged atom or the bare atomic nucleus of an element near the light end of the periodic table. In inertial confinement fusion, light ions are typically accelerated across a small gap in a high voltage short-pulse diode accelerator.

**Linac:** Linear accelerator; a device for accelerating heavy ions to drive inertial confinement fusion targets.

**Low-activation materials:** Materials that, under neutron irradiation, do not generate intensely radioactive, long-lived radioactive isotopes. Examples include certain vanadium alloys and ceramics such as silicon carbide. Fusion reactors made of low-activation materials would accumulate far less radioactivity over their lifetimes than reactors made with more conventional materials such as steels. Low-activation materials also produce less afterheat following a reactor shutdown than more conventional materials.

**Magnetic confinement:** Any means of containing and isolating a hot plasma from its surroundings by using magnetic fields.

**Magnetic field:** The property of the space near a magnet that results, for example, in the attraction of iron to the magnet. Magnetic fields are characterized by their direction and their strength. Electrically charged particles moving through a magnetic field at an angle with respect to the field are bent in a direction perpendicular to both their direction of motion and the direction of the field. Particles moving parallel to a magnetic field are not affected. Therefore, magnetic fields cannot prevent plasma particles from escaping along field lines.

**Magnetic fusion energy:** Energy released by a thermonuclear reaction in the fuel of a magnetically confined plasma.

**Magnetic mirror:** A generally axial magnetic field that has regions of increased intensity at each end where the magnetic field lines converge. These regions of increased intensity "reflect" charged particles traveling along the field lines back into the central region of lower magnetic field strength.

**Mirror:** See "Magnetic mirror."

**Muon:** A short-lived elementary particle that can be used to substitute an electron in a D-T molecule. It is much heavier than the electron thus reducing the size of the molecule and the distance between the nuclei. This effect makes fusion of the two nuclei much more likely to occur.

**Neutral beam heating:** Heating a confined plasma by injecting beams of energetic (typically greater than 100 keV) neutral atoms into it. Neutral atoms can cross magnetic lines of force to enter the plasma, where they transfer their energy to plasma particles through collisions. In these collisions, the neutral beam particles become ionized, and, like the other electrically charged plasma particles, are then confined by the magnetic fields.

**Neutral beam injection:** A technique of using high-energy beams of neutral atoms to penetrate the magnetic confinement fields of a fusion plasma for fueling, heating, and current drive. Once inside the plasma, the neutral atoms are ionized and are then confined.

**Neutron:** A basic atomic particle, found in the nucleus of every atom except the lightest isotope of hydrogen, that has no electrical charge. When bound within the nucleus of an atom, the neutron is stable. However, a free neutron is unstable and decays with a half-life of about 13 minutes into an electron, a proton, and a third particle called an antineutrino.

**Neutron flux:** A measure of the intensity of neutron irradiation. It is the number of neutrons passing through one square centimeter of a given target in one second.

**Plasma:** An ionized gaseous system composed of approximately equal numbers of positively and negatively charged particles and variable numbers of neutral atoms. The charged particles interact among themselves, with the neutral particles, and with externally applied electric and magnetic fields. The plasma state is sometimes called “the fourth state of matter” due to the fundamental differences in behavior between plasmas and solids, liquids, or neutral gases.

**Plasma current:** Electrical current flowing within a plasma. In many confinement schemes, plasma currents generate part of the confining magnetic fields.

**Plasma physics:** The study of plasmas.

**Proof-of-concept experiment:** An experiment done at a relatively early stage of development of a confinement concept to determine the limits of plasma stability, explore how the confinement properties appear to scale, and develop heating, impurity control, and fueling methods. Successful completion of such an experiment verifies that the confinement concept appears capable of operating successfully on a scale much closer to that needed in a reactor.

**Proof-of-principle experiment:** An experiment one stage beyond the “proof-of-concept” stage to determine optimal operating conditions, to establish that the concept is capable of being scaled to near-reactor level, to extend methods of heating to high power levels, and to develop efficient mechanisms for fueling and impurity control.

**Proton:** An elementary particle with a single positive electrical charge. Protons are constituents of all atomic nuclei. The atomic number of an atom is equal to the number of protons in its nucleus.

**Pulsed operation:** Noncontinuous operation of a fusion reactor. This term refers to reactors that must periodically stop and restart. In pulsed operation, individual pulses may last as long as hours.

**Reactor-scale experiment:** Experiment to test a confinement concept by generating a plasma equivalent to that needed in a full-scale reactor. Such an experiment must achieve reactor-level values of beta and must demonstrate temperature, density, and confinement times sufficient for the production of net fusion power. Furthermore, its heating, fueling, and other technologies must also be able to support a reactor-level plasma.

**Remote maintenance:** Conducting maintenance on reactor systems or components by remote control, rather than “hands-on.” Remote maintenance will be required in fusion reactors and in many future fusion experiments because the radioactivity levels near and inside the plasma chamber will be too high to permit human access.

**Reversed field pinch:** A closed magnetic confinement concept having toroidal and poloidal magnetic fields that are approximately equal in

strength, and in which the direction of the toroidal field at the outside of the plasma is opposite from the direction at the plasma center.

**Scaling:** Extension of results or predictions measured or calculated under one set of experimental conditions to another situation having different conditions. One of the most important functions of a confinement experiment is to determine how confinement properties scale with parameters such as device size, magnetic field, plasma current, temperature, and density. It is important to understand the scaling properties of a confinement concept—either empirically or theoretically—to assure that future experiments have a reasonable probability of succeeding.

**Scientific feasibility:** The successful completion of experiments that produce high-gain or ignited fusion reactions in the laboratory using a confinement configuration that lends itself to development into a net power producing system.

**Spheromak:** A magnetic confinement concept in which a large fraction of the confining magnetic fields are generated by currents within the plasma. The spheromak is a form of compact toroid.

**Steady-state operation:** Continuous operation, without repeated starting and stopping.

**Stellarator:** A toroidal magnetic confinement device in which the confining magnetic fields are generated entirely by external magnets.

**Superconductivity:** The total absence of electrical resistance in certain materials under certain conditions. Until recently, superconductivity had only been found to occur in certain materials cooled to within a few degrees of absolute zero. Since late 1986, however, a new class of materials has been discovered that become superconducting at temperatures far higher than the materials previously known. An electrical current that is established in a superconducting material will persist as long as the material remains below its critical temperature, the point at which it loses all resistance to electricity.

**System studies:** Studies presenting preconceptual designs for fusion reactors that serve to

uncover potential problems and determine how changes in design choices affect reactor characteristics. System studies are particularly valuable in guiding the research program by identifying areas where further research and development can have the greatest impact.

**Target:** In inertial confinement fusion, the structure or object containing the fusion fuel at which the driver beams are directed within the experimental chamber. Targets may consist of simple disks or pellets of fusion fuel or may be complex structures with many parts.

**Temperature:** A measure of the average energy of a system of particles. Given sufficient time and enough interaction among the different portions of any system, all portions will eventually come to the same temperature. In short-lived plasmas, however, the ion and electron temperatures usually differ because of insufficient interaction between the two. Plasma temperatures are measured in units of electron volts, with one electron volt equal to 11,605 K.

**Tokamak:** A magnetic confinement concept whose principal confining magnetic field, generated by external magnets, is in the toroidal direction but that also contains a poloidal magnetic field that is generated by electric currents running within the plasma. The tokamak is by far the most developed magnetic confinement concept. The word “tokamak” is a Russian acronym—TOroidal’naia KAMera s AKsial’nym magnitnym polem—meaning toroidal chamber with axial magnetic field. See also “Conventional tokamak” or “Advanced tokamak.”

**Toroidal:** In the shape of a torus, i.e. doughnut-shaped.

**Torus:** The shape of a doughnut, automobile tire, and innertube.

**Tritium (T or  $^3\text{H}$ ):** A radioisotope of hydrogen that has one proton and two neutrons in its nucleus. Tritium occurs only rarely in nature; it is radioactive and has a half-life of 12.3 years. In combination with deuterium, tritium is the most reactive fusion fuel.