

*The Big Picture: HDTV and
High-Resolution Systems*

June 1990

OTA-BP-CIT-64

NTIS order #PB90-256108

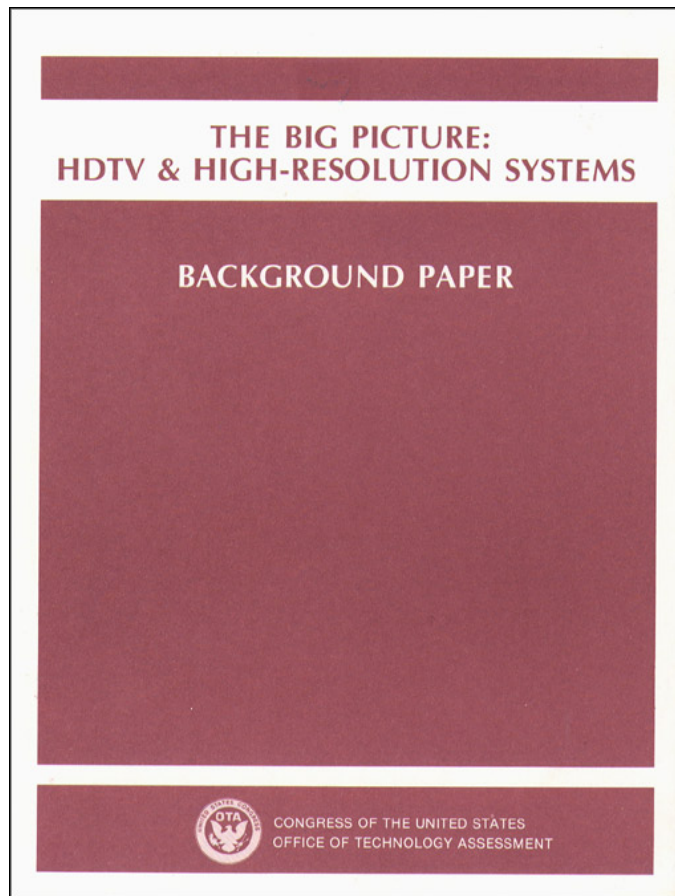

Recommended Citation:

U.S. Congress, Office of Technology Assessment, *The Big Picture: HDTV and High-Resolution Systems*, **OTA-BP-CIT-64** (Washington, DC: U.S. Government Printing Office, June 1990).

For sale by the Superintendent of Documents
U.S. Government Printing Office, Washington, DC 20402-9325
(order form can be found in the back of this report)

Foreword

As early as 1883 inventors dreamed of transmitting visual images to distant points extending what they had already done for written messages and voice with signals carried over the telegraph and telephone. By the 1920s, **significant** efforts were underway to scan and project images. Crude television images—actually little **more than shadows**—were demonstrated in 1926, and by 1928 even color images were achieved. Television broadcasts of the first television drama, *The Queen's Messenger*, were made from an experimental station in Schenectady, New York in 1928. TV was still futuristic at the time of the New York World's fair in 1939 but finally erupted into widespread commercial use in the 1950s. Now nearly a **half-century** later, technological change drives the video revolution unabated.

Television has become the dominant **entertainment** medium, and has displaced newspapers and radio as the prime opinion **maker** in American current affairs. Its influence reaches millions of individuals daily. It has been praised as an extraordinary educational tool, and its communication power has been credited with deeply influencing the actions of governments, including the fast-moving democratization of Eastern Europe. On the other hand, television is criticized as an agent of political manipulation that must share substantial blame for increasing voter apathy, and suffers with an image of daily **programming** dedicated to sitcoms, violence, and trivial game shows. Television has become big business, with production, broadcasting, advertising, video tapes, and the cable industries ranking high in the U.S. economy. Besides entertainment, this technology now profoundly affects communications, national security, research, and education.

Television technology is now on the threshold of a new evolution. We are on the verge of combining digital-based computer technology with television. This technological marriage promises to produce offspring that can deliver movie-quality, wide-screen programs to our homes with stereo sound equivalent to the best compact disks. Its importance goes well beyond home entertainment, however. High-definition television—HDTV as it is called—is linked with many other basic technologies important to the United States. The impacts of the development of HDTV will ripple through the U.S. economy: It will make us confront such issues as public policy dealing with manufacturing, educational and **training** standardization, communications, civil and military command and control, structural economic problems, and relationships between government and business.

This background paper was requested by Congressman George Brown, as a Member of the Technology Assessment Board. It is a primer of HDTV technology and its relationship to high-resolution computer systems. **OTA** gratefully acknowledges the contributions of the many experts, within and outside the government, who reviewed or contributed to this document. As with all **OTA** publications, however, the content is the responsibility of **OTA** and does not necessarily constitute the consensus or endorsement of reviewers or the Technology Assessment Board.

JOHN H. GIBBONS
Director

Workshop on High Definition TV and High-Resolution Systems, October 1989

Lynn Claudy
Staff Engineer
National Association of Broadcasters

Robert Cordell
District Manager
VLSI Systems Research

Birney Dayton
President
NVision

D. Joseph Donahue
Senior Vice President, Technology and Business
Development
Thomson Consumer Electronics

Bruce L. Egan
Special Consultant and Affiliated Research Fellow
Columbia University

Kenneth Flamm
Senior Fellow
Brookings Institution

Len Gelding
Vice President, Systems Engineering
Hughes Network Systems

Dale N. Hatfield
President
Hatfield Associates, Inc.

John G.N. Henderson
Head, Systems Technology
David **Sarnoff** Research Center

Wayne Luplow
Executive Systems, Electronic Systems R&D
Zenith Electronics Corp.

David G. Messerschmitt
Professor, Department of EE/CS
University of California, Berkeley

Howard Miller
Senior Vice President
Broadcast Operations & Engineering
Public Broadcasting Service

Michael Rau
Vice President, Science and Technology
National Association of Broadcasters

Griffith L. Resor
President
MRS Technology, Inc.

Robert L. Sanderson
Technical Assistant to the Director
Imaging Information Systems-Research
Eastman Kodak Co.

William F. Schreiber
Professor, **ATRP** Program
Massachusetts Institute of Technology

John Sie
Senior Vice President
Telecommunications, Inc.

Laurence J. Thorpe
Vice President, Production Technology
Sony Advanced Systems

Arpad G. Toth
Chief Scientist
Advanced Television Technology
Planning and Policy Development
North American Philips

Don Walker
Director of Technical Programs
Motorola, Inc.

John Weaver
President
Liberty Television

Philip Webre
Principal Analyst
Natural Resources and Commerce Division
Congressional Budget Office

Barry Whalen
Senior Vice President
Microelectronics & Computer Technology
Corp.

NOTE: OTA appreciates and is grateful for the valuable assistance and thoughtful critiques provided by the workshop participant members. The participants do not, however, necessarily approve, disapprove, or endorse this report. OTA assumes full responsibility for the report and the accuracy of its contents.

OTA Project Staff: The Big Picture: HDTV and High-Resolution Systems

John Andelin, *Assistant Director, OTA
Science, Information, and Natural Resources
Division*

Lionel S. Johns, *Assistant Director, OTA
Energy, Materials, and International Security
Division*

James W. **Curlin**, *Program Manager
Communication and Information Technologies*

Audrey **Buyrn**, *Program Manager
Industry, Technology, and Employment*

Samuel F. Baldwin, *Senior Analyst
Energy and Materials Program*

Mark S. **Nadel**, *Analyst
Communication and Information Technologies Program*

Myra Gray, *Executive Trainee
OPM Women's Executive Leadership Program*

Kenneth R. Donow, *Editor*

Administrative Staff

Liz Emanuel

Jo Anne Price

Karolyn St. Clair

OTA Contributors

Robin Gaster, *Senior Analyst
Industry, Technology and Employment Program*

Katherine **Gillman**, *Senior Associate
Industry, Technology and Employment Program*

Julie Gorte, *Senior Analyst
Industry, Technology and Employment Program*

Reviewers

Charles **Bostian**
Clayton **Ayre** Professor
Electrical Engineering Department
Virginia Polytechnic Institute and State University

Robert B. Cohen
Senior Economist, Industry Cooperation Council
Deputy Director & Senior Economist
New York State Financial Services Advisory
Commission
Economic Advisor to the Director of Economic
Development
Urban Development Corp.

Kenneth **Donow**
National Center for Telecommunication and
Information Policy
Public Service Satellite Consortium

Mark F. Eaton
Director
Associated Programs
Microelectronics & Computer Technology
Corp.

Frederick L. **Ikenson**
Attorney
Frederick L. **Ikenson, P.C.**

Clark E. Johnson, Jr.
Independent Consultant
Former Congressional Fellow

Alan McAdams
Associate Professor of Managerial Economics
Cornell University

Lee **McKnight**
Research Associate
Research program Communications Policy
Massachusetts Institute of Technology

Suzanne Neil
Research Associate
Media Laboratory
Massachusetts Institute of Technology

Peter D. Nunan
Senior **MTS/Manufacturing** Technology Development
Sematech

James Parker
Japanese Industry Analyst
TechSearch International, Inc.

Ron Powell
Scientific Assistant
Center for Electronics and Electrical Engineering
National Institute of Standards and Technology

Matt Rohde
U.S. Customs Service

Marko Slusarczyk
program Manager
High Definition Display Technology
DARPA

E. Jan **Vardaman**
President
TechSearch International, Inc.

Lawrence R. **Walders**
Graham & James

Contributors

Roy L. **Beasley**
consultant

Jules A. **Bellisio**
Division Manager
Video Systems Technology Research
Bellcore

Charles W. **Bostian**
Clayton **Ayre** Professor
Electrical Engineering Department
Virginia Polytechnic Institute and State University

Joseph A. **Castellano**
President
Stanford Resources, Inc.

Robert B. Cohen
Senior Economist, Industry Cooperation Council
Deputy Director & Senior Economist
New York State Financial Services Advisory
Commission
Economic Advisor to the Director of Economic
Development
Urban Development Corp.

Rhonda Crane
Advisor for Science and Technology
United States Trade Representative

Kenneth R. **Donow**
National Center for Telecommunication and
Information Policy
Public Service Satellite Consortium

Mark F. Eaton
Director
Associated Programs
Microelectronics & Computer Technology
Corp.

Charles H. **Ferguson**
Research Associate
Center for Technology, Policy, and Industrial
Development
Massachusetts Institute of Technology

William Finan
Director
Quick, **Finan** & Associates

Larry French
Corporate Vice President for Technology
North American Philips

Jeffrey Frey
Professor
Department of Electrical Engineering
University of Maryland

Jack **Fuhrer**
Director
Television Research Laboratory
David **Sarnoff** Research Center

William Glenn
Professor
Department of Electrical Engineering
Florida Atlantic University

David B. Hack
Analyst in Information in Science and Technology
Congressional Research Service

Heidi Hoffman
International Trade Specialist
U.S. Department of Commerce

C. Edward Holland, Jr.
Program Manager
OUSD(A) Resident
Semiconductor Research Corp.

William C. **Holton**, Ph.D.
Director, Microstructure Sciences
Semiconductor Research Corp.

James Hurd
President and Chief Executive Officer
Planar Systems, Inc.

Clark E. Johnson, Jr.
Independent Consultant
Former Congressional Fellow

Al **Kelsch**
Strategic Business Development
Linear Product Marketing
National Semiconductor

David M. Lewis
Technical Assistant to the Director
Electronics Research Labs
Eastman Kodak Co.

Mike **Liebold**
Apple Computer

Andrew B. Lippman
Associate Director
The Media Laboratory
Massachusetts Institute of Technology

Alan McAdarns
Associate Professor of Managerial Economics
Cornell University

Lee McKnight
Research Associate
Research Program Communications Policy
Massachusetts Institute of Technology

Dave **Mentley**
Director
Display Industry Research
Stanford Resources, Inc.

Suzanne Neil
Research Associate
Media Laboratory
Massachusetts Institute of Technology

W. Russell **Neuman**
Director
Audience Research
The Media Laboratory
Massachusetts Institute of Technology

Peter D. Nunan
Senior **MTS/Manufacturing** Technology Development
Sematech

Yozo Ono
Senior Engineer
NHK-North America

James G. Parker
Japanese Industry Analyst
TechSearch International, Inc.

Matthew Rohde
U.S. Customs Service

Eric J. **Schimmel**
Vice President
Telecommunications Industry Association

Richard Solomon
Research Affiliate
Research Lab of Electronics
Massachusetts Institute of **Technology**

David **Staelin**
Professor of Electrical Engineering
Massachusetts Institute of Technology

Lawrence E. Tannas, Jr.
President
Tannas Electronics

David L. **Tennenhouse**
Assistant Professor of Computer Science and Engineering
Massachusetts Institute of **Technology**

Antoon G. **Uyttendaele**
Director
Allocations & **R.R.** Systems
Broadcast Engineering
ABC Broadcast Operations & Engineering

E. Jan Vardarnan
President
TechSearch International, Inc.

Lawrence F. Weber
Senior Vice President
Plasmaco

Robin S. **Whiskin**
Executive Director
BIS Mackintosh

Contents

	<i>Page</i>
Chapter 1. Introduction and Summary	1
suMMARY	1
Manufacturing	1
Communications Infrastructure	2
Services	4
INTRODUCTION	4
The Historical Development ofHDTV(Ch. 2)	7
CommunicationsT echnologies (Ch. 3)	8
Television Technology (Ch. 4)..	8
Technological Linkages (Ch. 5)	9
AdvancedTelevision Markets (Ch. 6)	9
U.S. Manufacturing ofHDTV	10
POLICY ISSUES	13
NATIONAL SECURITY	16
THECOMMUNICATIONSINFRASTRU CruRE	17
Recorded Media	18
Terrestrial Broadcasters	18
Cable Television	19
Direct Broadcast Satellites	19
Mobile Communications	19
Telephone Companies	20
Market Share	20
costs	21
THE STANDARDS-SETTING PROCESS	22
Standards Setting and Marketplace Participants	23
The Timetable for Establishing Standards	23
Providing Full Opportunities for All Serious Proponents	24
Hybrid Standards	25
Chapter 2. The Historical Development ofHDTV	27
INTRODUCTION	27
JAPAN	27
Research and Development	28
Financial Supports	30
Market Promotion	31
EUROPE	32
Market Protection	33
Eureka	34
UNITED STATES	34
Production Standards	35
Transmissions tandards	36
New Initiatives	36
Chapter 3. Communications Technologies	39
INTRODUCTION	39
TERRESTRIAL RADIO COMMUNICATIONS	40
SATELLITE COMMUNICATIONS	44
COAXIAL CABLES	45
COPPER TELEPHONELINES	46
OPTICAL FIBER CABLES	47
Chapter 4. TVand HRS Technologies	49
INTRODUCTION	49
CONVENTIONALTELEVISION: PRODUCTION, TRANSMISSION, AND RECEPTION	49
ADVANCED TELEVISION SYSTEMS: IDTV,EDTV, HDTV	52
VISUAL RESPONSE ANDHIGH DEFINITION TV	52
HDTV SYSTEMS: PRODUCTION, TRANSMISSION, RECEPTION	55
Production Standards	56
Transmissions systems	56

	<i>Page</i>
Receivers for HDTV	58
HIGH-RESOLUTION SYSTEMS AND TECHNOLOGIES	59
Chapter 5. Linkages Between HDTV, HRS , and Other Industries *.*.....	61
INTRODUCTION	61
SEMICONDUCTORS	63
Digital Signal Processing	63
DRAMs	65
Gallium Arsenide and Other Compound Semiconductors	66
Semiconductor Manufacturing ..1	67
DISPLAY TECHNOLOGY	68
STORAGE	72
COMMUNICATIONS	73
PACKAGING/INTERCONNECT	74
Chapter 6. Advanced TV Markets and Market Uncertainties	79
INTRODUCTION	79
SCENARIOS FOR MARKET DEVELOPMENT	79
Consumer Demand for HDTV	80
Consumer Demand for Interactive Video	81
Government Policies and Market Development	82
MARKET PROJECTIONS	83
MARKET PROJECTIONS AND THE RELATIVE IMPORTANCE OF HDTV	85
Extrapolating Current Growth Trends	85
Comparing the Semiconductor or Other Component Requirements for Assumed Market Sizes	86
Comparing Ultimate Market Penetration Rates and Corresponding Needs per user	87
TECHNOLOGY AND MARKET TRENDS	88
Appendix A. The Decline of the U.S. TV Industry: Manufacturing	91
Appendix B. The Decline of the U.S. TV Industry: Trade	93
Appendix C. The Decline of the U.S. DRAM Industry: Manufacturing	95
Appendix D. The Decline of the U.S. DRAM Industry: Trade	98
Appendix E. The Development of the Japanese Computer Industry	101
Appendix F. Research and Development Consortia	104
Appendix G. Acronyms and Glossary	106

Boxes

<i>Box</i>	<i>Page</i>
1-1. Digital Video Information and Telecommunications Services	5
3-1. Fundamentals	41
4-1. Inside Today's NTSC Analog Television	50
4-2. Inside Analog/Digital Television	53
4-3. Levels of Receiver Compatibility	57

Figures

<i>Figure</i>	<i>Page</i>
1-1. Erosion of U.S. Leadership in Semiconductor and Related Technologies	3
3-1. Amplitude and Frequency Modulation of a Carrier	41
3-2. A Digital Signal With Its Corresponding Numerical Equivalent	41
3-3. Techniques for Modulating an Analog Carrier in Order To Send Data in a Digital Format	42
3-4. Selected Allocations of the Radio Frequency Spectrum	43
3-5. Map of a Cellular Radio System	44
4-1. Analog to Digital Conversion Using Pulse Code Modulation	53
4-2. Comparison of the Field of View for an HDTV and T*y's NTSC TV To Have the Same Resolution for the Viewer	55
5-1. Selected Applications of Digital Signal processors v. the Speed of Operation	64
5-2. Projected Growth of the Digital Signal Processor Market , 1989-92	65
5-3. "Resor's Rule" for Active Matrix Liquid Crystal Displays	69

	<i>Page</i>
5-4. Data Transmission Rates and Holding Times for Different Types of Data Communications	74
5-5. Levels of Packaging/Interconnect	75
5-6. Fraction of Integrated Circuits Used in Surface-Mount Packages for Japan, Europe, and the United States	77
6-1. Sales of VCRs, VCR Prices, and the Growth of VCR Tape Rental Stores	81
6-2. Penetration of Color TVs Into American Households, Average TV Prices, and the Share of Prime-Time Programming Devoted to Color TV	82
6-3. Sales and Projections of Video Entertainment Technologies in the United States and Japan	84

Tables

<i>Table</i>	<i>Page</i>
2-1. Selected HDTV Technology Development Efforts by Japanese Companies	29
2-2. Chronology of TV Development	36
2-3. Private U.S. Groups Involved With HDTV	37
3-1. The U.S. Communications Infrastructure	39
5-1. Status of U.S. Producers of Flat Panel Displays in the 1980s	71
5-2. Recent Investments in AM/LCD Production Facilities in Japan	71

Introduction and Summary

SUMMARY

During 1989, High Definition Television (HDTV) moved from obscurity to center stage in the ongoing debate over the role of the Federal Government in U.S. industrial competitiveness. HDTV and related High-Resolution System (HRS) technologies in the computer and communications sectors may significantly impact U.S. electronics manufacturing, accelerate fundamental restructuring of the U.S. communications infrastructure, and provide a host of valuable services.

Manufacturing

HDTVS must process huge quantities of information at speeds approaching those of today's **supercomputers** in order to display a real-time, full-color, high-definition video signal. HDTVS are able to do this at relatively low cost through the use of circuitry dedicated to specialized tasks. In contrast, **supercomputers** are software programmable and do a much broader range of information handling and computation.

HDTV is driving the state-of-the-art in a number of technologies that will be important to future generations of computer and communications equipment. These include certain aspects of digital signal processing for real-time video signals; high-performance displays; fast, **high-density** magnetic and optical data storage; technologies for packaging and interconnecting these electronics; and, as with all high-volume consumer electronics, processes for manufacturing these sophisticated products at affordable costs.

Consumer electronics has long been the principal driver of important aspects of these and other technologies. For example, television has long pushed display technology. VCRs, compact disks, and digital audio tape have driven important data storage technologies.

Products such as calculators, watches, and LCD TVs have been important in the development of **packaging/interconnect** technologies such as tape automated bonding and surface mount. Light-emitting diodes (**LEDs**) in watches, calculators, and indicators; and diode lasers in CD-players are examples of important optoelectronic technologies driven by the consumer market. Finally, important manufacturing technologies, such as automatic insertion equipment to place components on printed circuit boards, were developed for the high-volume consumer electronics industry.

Video entertainment markets will be worth billions of dollars, whatever form they take in the future. The economies of scale realized in producing for markets this large combined with the technological linkages noted before may aid manufacturers in penetrating other markets using similar products and technologies, particularly the computer and communications sectors.

Consumer electronics is characterized by fierce competition, large volume production, and low profit margins. Because of this, consumer electronics may be the equivalent of the "coal miner's canary" for manufacturers of electronics—providing a sensitive indicator of their managerial and technical performance in design, production, and quality; of the health of the environment they operate in (macroeconomic, regulatory, and structural); and of the effectiveness of government policy towards foreign trade practices. Consumer electronics manufacturing is nearly dead in the United States. Much of what remains is domestic "screwdriver assembly" of components and subassemblies produced abroad.

Congress might question the wisdom of any further government involvement in HDTV if they view the technology in a narrow sense—as nothing more than a near-term improvement over today's TV. However, if it is viewed

broadly—as a possible first step back into consumer electronics manufacturing; as a **principal** driver of **HRS** technologies for future computer and communications equipment; or as a component of a national fiber information network with HDTV or related products serving as the home terminal—then Congress may find that HDTV and related **HRS** technologies could contribute to several national goals.

HDTV may also be an instructive case study of the difficulties facing the United States in reversing the erosion of U.S. leadership in many electronic technologies and in global and domestic electronics markets (figure 1-1). The United States is seriously lagging technically and/or in market share in semiconductor materials; ceramic packaging; DRAMs, gate arrays, CMOS and ECL devices generally; LCD displays; optoelectronics; and floppy disk and helical scanning drives (VCRS); to name only a few. The United States will not long remain a world leader in electronics technologies if its technological foundation continues to crumble in this manner.

HDTV and related **HRS** will not by themselves determine the fate of the entire U.S. electronics industry. They will only have a direct impact on technologies and products for handling visual information, and these impacts will not begin to be felt for several years. In the near- to mid-term, the U.S. electronics industry faces substantial challenges. Many technologies must be developed—including materials, x-ray lithography, large-area lithography, optoelectronics, packaging/interconnect, and others—and much greater effort must be devoted to manufacturing with quality at low cost.

The responses to these challenges should not be viewed as independent efforts. The electronics industry is a complex and highly interdependent whole. For example, the design of leading-edge microprocessors requires access to high performance computers which, in turn, depend on leading-edge materials, semicon-

ductor manufacturing equipment, packaging/interconnect, and other leading-edge technologies. Manufacturing these microprocessors will become increasingly difficult if vertically integrated foreign competitors control the basic materials and semiconductor manufacturing equipment. Selling them will be similarly difficult if these foreign competitors control most other components (memory and other chips, optical and magnetic storage, displays); have superior **packaging/interconnect** and assembly technologies (e.g., chip on glass); and prefer to use their own microprocessors instead of purchasing them from U.S. manufacturers. Although the fragmented entrepreneurial U.S. electronics industry is remarkably **innovative**, giant foreign corporations can easily invest more heavily in critical technologies or simply buy out the U.S. entrepreneur.

HDTV and **HRS** should thus be viewed as only part of a larger and more comprehensive effort to understand and resolve the problems facing the U.S. electronics industry. These include: the high cost of capital; lack of vertical and/or horizontal integration; inattention to manufacturing process and quality, poor design for manufacturability, and the separation of R&D from manufacturing; poor or adversarial relationships with suppliers; weakness in the U.S. educational system; industrial and trade policies in other nations that have aided competitors; inadequate foreign protection of U.S. intellectual property; and foreign trade violations and closed foreign markets. These issues are discussed in greater detail in a recent OTA report.¹

Communications Infrastructure

The communications industry is currently undergoing dramatic, technology-driven change through the increasing use of digital electronics and fiber optics. In the midterm, the continued incorporation of advanced electronics and **photonics** into the existing public telephone net-

¹U.S. Congress, Office of Technology Assessment, *Making Things Better: Competing in Manufacturing*, OTA-ITE-443 (Washington, DC: U.S. Government Printing Office, February 1990).

Figure I-1—Erosion of U.S. Leadership in Semiconductor and Related Technologies

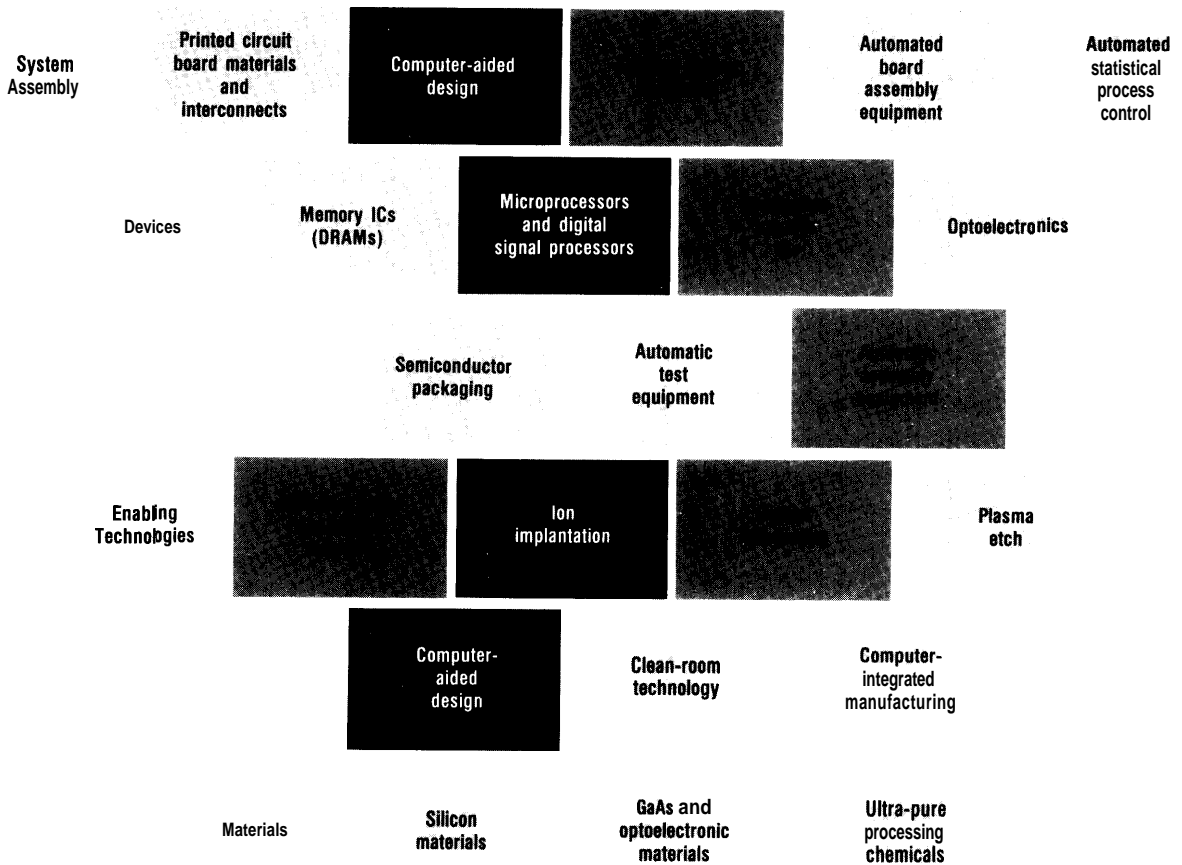

Technologies in which the United States is lagging Japan are shown in light tones; those in which the United States and Japan are roughly equal are shown in medium tones; those in which the United States is leading Japan are shown in dark tones.

SOURCES: Adapted from the Report of the Federal Interagency Staff Working Group, "The Semiconductor Industry," National Academy of Sciences, 1987; National Research Council, *Advanced Processing of Electronic Materials in the United States and Japan* (Washington, DC: National Academy Press, 1988); W.C. Holton, J. Dussault, D.A. Hodges, C.L. Liu, J.D. Plummer, D.E. Thomas, and B.F. Wu, "Computer Integrated Manufacturing (CIM) and Computer Assisted Design (CAD) for the Semiconductor Industry in Japan," JTECH Panel Report, Department of Commerce, Science Applications International Corp., December 1988; Manufacturing Studies Board, *The Future of Electronics Assembly: Report of the Panel on Strategic Electronics Manufacturing Technologies* (Washington, DC: National Academy Press, 1988).

work will make many new and improved interactive information services available. Radio frequency communications are also rapidly changing due to such innovations as cellular telephones and other products.

HDTV could accelerate these changes in the communications infrastructure. The greater information content of HDTVs broadcast signal has raised the most significant issues for radio frequency spectrum allocation in decades. HDTV bandwidth requirements present problems for

making the transition to terrestrial HDTV broadcasting, but digital technologies offer the prospect of more efficient use of the limited available spectrum than is possible with today's TV system—which is based on 40-year-old analog electronics technologies. Some of the broadcast spectrum might thus eventually be freed for other uses. For example, it has been suggested that if sufficient spectrum became available, cellular telephones could become more broadly competitive with today's phone system for voice communications.

HDTV might also speed the extension of fiber to the home by stimulating market demand for high-quality video entertainment. In the mid-term, a mixed cable TV and telephone company network might provide a modest level of interactive video services. Whether or not such a system can evolve into a national two-way broadband fiber network is unclear. This is an important consideration in establishing a financial and regulatory framework for the communications industry.²

Services

HDTV and related HRS technologies may offer a host of important services to individuals as well as to business and industry. Interactive video, medical imaging, desktop publishing, and computer graphics are examples of services already in advanced stages of development or on the market for high-end commercial users (box 1-1). Other services may not be developed for many years, and many more remain to be invented. Video information technologies will become increasingly important in computer and communications systems in order to make best use of the most important human sense—vision.

The United States has the opportunity to establish a more powerful and flexible HDTV system than those currently being developed and introduced in Japan and Europe. America has many strengths in HDTV and HRS-related component technologies, as well as in highly innovative HDTV transmission standards and receiver designs now under development in a number of U.S.-based facilities.

The window of opportunity for U.S. firms to enter or to strengthen their position in these markets could close quickly, however, if the strategies of foreign competitors are successful. Many U.S. firms seriously lag in manufacturing practices—both managerial and technological—and there is little consumer electronics manufacturing remaining in the United States on which to build. These deficiencies could be overcome—

the Japanese surmounted far greater obstacles in developing their domestic computer industry (app. E)—but doing so would require considerable effort and discipline on the part of both U.S. industry and government.

INTRODUCTION

HDTV is one of several possible forms for the next generation of home video entertainment; following Black and White (B&W) TV in the 1940s, color TV in the 1950s, and VCRs in the 1970s. It promises to deliver pictures to the home as clear as those seen in movie theaters, with sound comparable to compact disk players.

But HDTV is far more than just a pretty picture. It is part of an ongoing evolution in home electronics toward computer-like digital technologies. This evolution began with such things as automatic electronic tuners on stereos and TVs, compact disk players, and electronic controls on microwave ovens and many other household appliances. It continues today with the introduction of Improved Definition TV (IDTV) that uses computer memories and other digital techniques to provide a much better picture even with today's broadcasts. The evolution will continue in the future with HDTV or other advanced video entertainment products.

HDTV is also at the leading edge of a much broader, though less well publicized, transition in computers and communications equipment to technologies that can create, manipulate, transmit, and display high-quality visual information, including full-motion video as seen on television receivers. In many respects, Advanced TV (ATV), interactive video, computers, and communications are all gradually merging technologically. Known generically as High Resolution Systems (F-I'M), these systems will allow the user to interact with that being displayed, and will have profound implications for education, entertainment, and work in the future.

²See, U.S. Congress, Office of Technology Assessment, *Critical Connections: Communication for the Future*, OTA-CIT-407 (Washington, DC: U.S. Government Printing Office, January 1990).

Box 1-1—Digital Video Information and Telecommunications Services

Digital video information and telecommunications technologies (**DIVITECH**) may potentially offer a variety of services beyond entertainment. Some of these are listed below.

Telemedicine—**B**ecause of its high resolution and true rendition of color, advanced video communications technologies could be used to transmit medical images such as x-rays, CAT scans, or color pictures of tissue to leading experts in distant cities for instant diagnosis. A distant **expert** might even observe and provide advice during a critical operation. People in rural areas with little access to world class medical facilities could particularly benefit.

Education—Recent advances in manipulating digital video data allow the viewer to interact directly with real-world images. For example, the viewer can “stroll” through ancient Athens at will, the computer selecting and displaying the appropriate audio and video signals (pre-recorded **on** location) in response to the viewer’s direction. The viewer could similarly examine the effect of different strategies on the outcome of a battle; take apart and rebuild an auto engine; or dissect a frog, with detailed information available on demand on how each part works individually and with other parts. This ability to interact with what is being displayed will make these technologies far more important to education than today’s TVs. Advanced video technologies could thus be used widely in education, from **pre-school** through medical school.

Simulation—Engineering simulation, including computer aided design of structures, electronic components and equipment, aircraft, and a host of others is already a vital market. As for interactive video, recent advances in computer-generated images could extend simulations to such things as building design—where a prospective client might take a realistic “walk” through a proposed design.

Photography—Pictures taken by electronic still cameras could be displayed on a screen or sent over a network for immediate printing at a distant film developer. With computer assistance, photographic-quality images and digital audio might one-day be edited almost as **easily** as words are today.

Telecommunications—A host of new services, ranging from videophones and teleconferencing to telemarketing new goods could become available to the consumer. One might even design a personal **telene newspaper** by using a computer program to search the news services, TV news, PBS educational programs, and others for written or video information of particular interest that could be stored and later displayed—for example, at breakfast time.

Publishing—Desk-top publishing using personal computers has already revolutionized the business. Advanced video technologies will accelerate this **by** allowing the transmission and display of high-quality visual material. **NYNEX** is now experimenting with the transmission of advertising copy between agencies and clients over a fiber-optics network in New York City.

Defense—**HRS** technologies could enhance many of today’s defense technologies. Examples might include: using electronic cameras for **reconnaissance** to eliminate the delays and logistics in processing film; providing high resolution maps for targeting and/or very close-in air support of ground troops; or improving cockpit displays for **pilots**—**overlaying** information about incoming missiles, ground fire, or aircraft with **fuel** availability and weapons’ status on a display of the upcoming target.

SOURCES: Paul Kemezis, “HDTV Slowly Moves Into Medical Applications,” *New Technology Week*, Aug. 15, 1988; Arch C. Luther, “You Are There. . . And In Control,” *IEEE Spectrum*, September 1988; William Booth, “Bending Reality’s Borders,” *Washington Post*, Oct. 23, 1989, p. A3; “What’s Ahead in Phones and High-Resolution TV,” *Science Focus*, vol. 3, No. 2, Fall 1988, New York Academy of Sciences; U.S. General Accounting Office, “High-Definition Television: Applications for This New Technology,” December 1989.

Early generations of these technologies are already affecting our professional lives in important ways. High-performance graphics-based workstations and personal computers, laser printers, copiers, fax machines, and other technologies are revolutionizing the office. Interactive video systems are becoming available that allow an architect to “stroll” through a building being designed, or a student to call up

video material in an electronic encyclopedia. At home or in the office, this fusion of computer, communications, and imaging technologies will make widely accessible a host of new services (box 1-1).

Similarly, many government activities could benefit from HRS technologies. For example, the Federal Aviation Administration (FAA) has

already contracted with Sony (Japan) for high-resolution displays to monitor air traffic. The military could use these technologies for training simulators, command and control centers, teleconferencing, and aerial **reconnaissance**—eliminating the delays and difficulties inherent in processing film. NASA could use HRS technologies for deep space exploration, remote sensing of the Earth, and for monitoring launches. For example, higher resolution pictures would have aided the analysis of the Space Shuttle Challenger tragedy. In March 1989, NASA conducted its first test of HDTV by videotaping the launch of the Discovery shuttle and transmitting the pictures within the Space Center and as far away as Orlando, Florida, by fiber-optic links.³

The role of HDTV as a consumer product in the future information society remains unclear. Skeptics portray HDTV as simply providing better entertainment for “couch potatoes,” and claim that there will not be a sufficient consumer market to support a more complex or capable technology. Advocates portray HDTV as the basic technology platform on which tomorrow’s home and perhaps even office information services will be built—a veritable keystone for the video information archway of the future.

Although such scenarios suggest that HDTV might eventually become the home information center—providing entertainment, computer, and telecommunications services—it is perhaps more likely that these different services will instead continue to be primarily provided by separate, specialized pieces of equipment. People simply work that way. While the teenager is on the videophone, one parent could watch video on a big screen in the family room, while the other parent could use the computer in the study to balance the monthly finances.

HDTV might thus be one of three platforms for home information services, the others being the computer and the videophone. (In homes

that would not otherwise purchase a computer, the HDTV might serve as an affordable means of providing some computing power and would then open a wide range of services.) All three types of equipment will probably evolve common basic designs that allow easy exchange of information among them and could significantly overlap in the services they provide. Overtime, it may become increasingly difficult and moot to distinguish these different types of digital equipment from each other. The large, high-quality screen of the HDTV might be the most notable difference.

These video information services will neither replace today’s media quickly, nor will they until they provide significantly greater functionality at an affordable price. For example, simply reprinting a newspaper story on a bulky, hard-to-read ATV or computer display **will** not induce people to give up the convenience of newspapers, which can be carried around and read anywhere. But video information services that deliver more in-depth information on a news program upon request; can send a movie clip to a friend; or provide electronic yellow pages that include video clips of restaurants that **viewers** might want to try could attract a great many newspaper readers (a possibility of obviously great concern to the newspaper **industry**⁴).

Despite the potential impacts of HDTV and related HRS technologies on U.S. electronics manufacturing and on the U.S. communications infrastructure, and, despite the opportunities that new video information services may offer, the United States significantly lags Japan and Europe in developing and manufacturing many of these products.

This report focuses primarily on consumer HDTV for several reasons: HDTV raises thorny policy issues; HDTV is driving a number of technologies and manufacturing processes for HRS more generally; and HDTV may significantly impact our communications infrastruc-

³Richard Doherty, “HDTV Cameras Capture Shuttle Launch,” *Electronic Engineering Times*, Mar. 20, 1989, p. 19.

⁴“Should the U.S. Free the Baby Bells?” *Business Week*, Mar. 12, 1990, p. 124.

ture through possible radio frequency spectrum reallocation and perhaps by accelerating the deployment of fiber-optic systems.⁵

Less attention is paid to intermediate forms of Advanced TV such as Improved Definition or Extended Definition TV (IDTV, EDTV): IDTV has little impact on the communications infrastructure; EDTV'S impact on communications is modest and EDTV may be bypassed if simulcast systems are chosen; and neither IDTV nor EDTV are driving technologies as hard as HDTV is today.

Less attention is also given to alternative forms of video entertainment and information systems such as interactive video: it has little impact on the communications infrastructure; it may become an element of the discussion of HDTV if flexible designs for HDTV receivers are chosen as the U.S. standard; and it faces many of the same questions about consumer appeal as HDTV.

There is similarly little discussion of video program production: it provides the United States a net \$2.5 billion trade surplus—compared to a \$5 billion⁶ trade deficit for consumer video equipment—and it has little impact on either U.S. manufacturing performance or the U.S. communications infrastructure.

Finally, the market for video production equipment is smaller than that for household video equipment. There is less emphasis on the much larger generic category of High Resolution Systems—which represent much of future computer and communications systems—than for HDTV. These areas will be referred to briefly throughout this study, and will be discussed in more detail in future OTA reports.

The Historical Development of HDTV (Ch. 2)

The Japanese have been selling HDTV studio production equipment since 1984 and are now gearing up large-scale commercial production of HDTV receivers. The Europeans began a

crash program in June 1986 and now lag the Japanese by just 2 to 3 years. In contrast, the United States will not even begin testing to establish HDTV transmission standards until mid- 1990 and U.S.-manufactured HDTVS could not likely be commercially available until 1993 or 1994.

The Japanese effort is particularly noteworthy. Japan considers HDTV to be an important step into the future information society. It foresees numerous technological linkages between HDTV, High Resolution Systems, and other parts of its highly successful electronics industries. As in other countries, the Japanese face the “chicken-and-egg” problem of who invests first: consumers will not buy HDTVS until the price comes down and there are enough HDTV programs to watch, but manufacturers cannot reduce the unit price until sales volumes are large, and movie producers and broadcasters will not provide HDTV programs until there is a sufficient audience. The Japanese believe that the best way to overcome this problem is by sharing the costs and risks between the government and the private sector. The Japanese Government has therefore spun a complex web of direct and indirect R&D, financial, and market promotion efforts to stimulate the development of the HDTV market.

In contrast, all U.S.-owned firms, except Zenith, have abandoned the TV receiver manufacturing business. Many factors contributed to this exodus of U.S. firms, including: the relatively poor manufacturing performance by some U.S. firms (see app. A); and the failure of the U.S. Government to protect U.S. industry from foreign trade violations (see app. B). As a result of the loss of the U.S. TV market, the little work done on HDTV in the United States has largely been by or for foreign-owned consumer electronics firms or by small, underfunded university programs and entrepreneurs. The Defense Advanced Research Projects Agency's (DARPA) planned R&D program is the most significant

⁵The term HDTV is, on occasion, used loosely to include Advanced TV systems generally.

⁶Sarah Hall, International Trade Administration, U.S. @-@ of Commerce, personal communication, Nov. 16, 1989.

recent step to reverse this, but there are serious questions about the Administration's commitment to this effort.

Communications Technologies (Ch. 3)

Historical, economic, and technological factors have combined to provide the United States five major electronic communication media: terrestrial and satellite communications using the radio frequency spectrum; coaxial cables for TV; twisted copper pairs of wires in the telephone network; and, recently, optical fiber for the high traffic "backbones" of both the telephone and cable TV networks.

The greater information content of HDTV'S broadcast signal will require changes in the allocation and use of the existing TV broadcast channels and could potentially free spectrum for use in mobile communications and other services. HDTV could spur the use of Direct Broadcast Satellites (DBS) and might also speed broader use of fiber optics in cable and possibly telephone networks by stimulating market demand for high-quality video entertainment.

Television Technology (Ch. 4)

Video entertainment systems may take a variety of forms in the future, including (in order of increasing picture quality) Intermediate Definition TV, Extended Definition TV, and High Definition TV; or perhaps various forms of interactive video either in conjunction with these Advanced TVs or as separate systems. Of all ATVS currently under advanced development, HDTV may have particular consumer appeal because of its greater potential for providing viewers the feeling of 'being there' that one sometimes gets in watching a high-quality motion picture up-close and, for example, having the sense of moving with a stunt plane when it makes a fast turn.

Television systems have three general functions—production, transmission, and reception of TV programming—all of which will require substantial changes from today in order to make the transition to HDTV.

Production

International efforts are currently focused on developing common production formats that will allow easy conversion between different regional standards. Earlier attempts to establish a single global production standard foundered on the lack of compatibility between existing systems and the cost of converting from one to another. Early recognition by European interests of the potential competitive threat to their domestic electronics manufacturing posed by having a single common standard based on the Japanese system was also a factor in stopping the establishment of a single global production standard.

Transmission

It is difficult to squeeze the greater information content of an HDTV signal into the channel bandwidths allocated to terrestrial broadcasting, especially given the inefficiencies of conventional color TV signals. The Japanese and Europeans have therefore opted to instead develop HDTV services through Direct Broadcast Satellite (DBS) systems operating at higher frequencies not currently heavily used. In the United States, the greater importance of the existing broadcasting system, issues of localism and programming diversity, and other factors make the development of a terrestrial HDTV broadcasting capability for HDTV more important than it is in Japan or Europe.

Terrestrial transmission systems proposed for Advanced TV services in the United States are based on augmentation of the existing NTSC transmissions with an additional 3- or 6-MHz signal; or on simulcasting (simultaneously broadcasting) in the channels now left vacant to prevent interference between stations (taboo channels). Although the NTSC system was a remarkable triumph when it was developed—given the electronics technologies of the 1950s—more efficient use of the broadcast spectrum is now possible with today's electronics technologies. Augmentation systems will continue to use, in part, the NTSC system and may thus tend to lock into place less efficient use of the

broadcast spectrum. In contrast, simulcast systems might eventually allow a large amount of radio frequency spectrum now reserved for NTSC broadcasts to be vacated and used for such services as mobile communications.

Receivers

Advanced TV receivers of greatest interest in the near-term are the **Multiport Receiver** and the **Open Architecture Receiver (OAR)**. **Multiport** receivers would be adaptable to a limited range of predetermined broadcast standards and would provide limited access for adding voice/data/video **communications**.⁷ OARS follow the path pioneered by the personal computer industry and would be adaptable to a much broader set of broadcast standards, personal communications, computer functions, or other services that might be of interest to consumers. This could open a host of new markets for entrepreneurs.

Advanced TV systems are evolving naturally from today's conventional, largely analog systems through the increasing use of computer-like digital electronics. This evolution of TV technology to digital electronics is inexorable, even if its speed is uncertain. Similarly, computer and communications systems are evolving towards greater use of still and video images as now seen primarily on TV. Advanced TV, computer and telecommunications systems are expected to continue to evolve towards reasonably common forms—**HRSs**. The impact of HDTVs and **HRSs** if connected to a national fiber communications network could revolutionize information services.

Technological Linkages (Ch. 5)

HDTV is driving the state-of-the-art in certain digital signal processing, data storage, display, **packaging/interconnect**, and other technologies, as described above. As with consumer electronics generally, HDTV will also push the limits of cost-effective manufacturing. This could be one of the most important impacts of HDTV for the United States.

The expectation of a large market is forcing potential HDTV manufacturers to push the state-of-the-art in several areas of HDTV-related technologies. These technological linkages could assist HDTV producers in other HRS markets. Simply developing technologies does little good, however, without markets to sell in.

In the past, the United States has tended to assume that if technologies were developed, markets would follow. Faced with large, often vertically integrated and aggressive foreign competitors, market shares may be as important as technology development. These foreign firms are much more likely to use their own internally developed semiconductors and other components than to buy them from a U.S. firm (as might a vertically integrated U.S. firm). Some foreign firms are also more likely to buy components they don't make internally from local suppliers with whom they have long-term preferential relationships. These relationships can be very difficult to crack, regardless of the price or performance of the **technology** offered by the outsider.

Controlling the market, however, is not enough. Even with a strong technology base and 70 percent of the world's personal computer market, the United States still lost the (merchant) DRAM industry to Japan. This was due to a variety of factors, including: relatively less efficient manufacturing by some U.S. firms (**app. C**); foreign trade violations and closed foreign markets (**app. D**); and industry and trade policies in Japan that encouraged heavy investment in and rapid development of their domestic industry.

Advanced Television Markets (Ch. 6)

Forecasts based on analogies with past **successful** products, project U.S. sales of HDTVs at 10 to 15 million sets annually within 15 years. Some expect a large business/industry market for HDTV equipment to develop much sooner. Yet others suggest that the HDTV market will

⁷Arpad G. Toth and Joseph Donahue, "An Multiport Receiver: Preliminary Analysis," *First Report of the EIA ATV Multiport Receiver Committee*, Sept. 11, 1989.

not develop and that consumer needs can be met by intermediate products such as Improved Definition TV or Extended Definition TV, or instead by products such as interactive video. In fact, there will probably be markets for all of these products. The large uncertainties in how video entertainment markets will develop in the future should not obscure the underlying trend in consumer video towards digital electronics, high-performance flat panel displays, high-density optical and magnetic recording, and other key technologies.

The HDTV market projected by these forecasts varies between \$5 billion and \$12 billion (1988 dollars) by 2003. VCRs, movie production, and broadcasting equipment increase these potential values. The overall U.S. consumer electronics market was worth \$30 billion in factory sales in 1987 and is growing rapidly.⁸ The High Resolution System market will be larger yet, encompassing a broad array of imaging and image processing markets in the computer, consumer electronics, and telecommunications sectors.

The relative importance of the future HDTV market has also been compared with that of the computer sector. Such comparisons are not very useful; there are simply too many uncertainties. Regardless of the precise form consumer video products take in coming years, the consumer electronics sector will continue to be a large and important market, and video entertainment will continue to be its most important component. Computers and communications equipment will also make greater use of still and video images, but they will probably lag consumer video in driving some of the key technologies such as digital signal processing, high-performance displays, optical and magnetic storage, and certain manufacturing processes.

U.S. Manufacturing of HDTV

Proponents argue that government support for HDTV and related HRS R&D might serve several national goals.

HDTV might serve as a stepping stone for U.S. firms to reenter consumer electronics manufacturing. Consumer electronics is a large market; it also supports many upstream industries. For example, roughly one-fourth of Japanese semiconductor output is currently used in consumer products, and TVs and VCRs are a major portion of this.⁹ Similarly, 70 percent of the \$8 billion (1988) world display industry is for consumer products. There will continue to be a large demand for video entertainment and other consumer electronics equipment, regardless of the specific form these technologies take. As noted above, consumer electronics is also an important driver of manufacturing processes.

HDTV might serve as a principal driver of many High Resolution System (HRS) technologies due to the exceptional demands it places on display, video processor, storage, and other technologies. At one time, U.S. firms could ignore the consumer electronics market at less risk because analog electronics were used. With the shift of consumer equipment to digital electronics, the linkages to the computer and telecommunication industries are becoming much more important. U.S. firms can no longer ignore the consumer market with impunity.

HRS technologies will be very important to the computer and communication industries in coming years. As a forerunner to video, manufacturers sold roughly 9 billion dollars' worth of hardware and software in the United States in 1988 for commercial graphics applications, with sales expected to rise to over \$25 billion by 1993.¹⁰ There are similarly large markets for display technologies; for imaging equipment such as facsimile machines; and for telecommu-

⁸Electronic Industries Association *Consumer Electronics Annual Review, 1988 ed.*, Washington, DC.

⁹"Japan Electronics Almanac," Dempa Publications, various years; Kenneth Flamm, Brookings Institution personal communication VCRs alone account for 12 percent of total Japanese IC production: "TV's High-Stakes, High-Tech Battle," *Fortune*, Oct. 24, 1988.

¹⁰"The Graphics Revolution," *Business Week*, Nov. 28, 1988.

nications equipment, including that using **wide-band** switching and fiber optics. American firms are increasingly lagging foreign competitors in many of these technologies; more R&D is needed, together with greater attention to manufacturing with quality at affordable prices.

Finally, HDTV or related **HRS** might serve as the home terminal on a national fiber information network. In the midterm, the Integrated Services Digital Network (**ISDN**) will make possible a host of information services short of high-quality real-time video. In the longer term, a national two-way fiber network would make possible many desirable video information services. If a national fiber network is made a national goal, then policies to aid its implementation should be put into place in the near-term. These might include a framework to encourage additional effort in developing and manufacturing video information systems.

Skeptics insist that if HDTV is important, industry will invest in it independently and will do so more wisely than the government could; that there is no need for government support.

Skeptics argue that HDTV is likely to be a relatively small market (at most \$30 billion in 20 years) compared to the entire world electronics market (which is already \$450 billion or more) and can therefore be ignored. The same argument could be made about almost any segment of a market and ignores the relative importance of specific products in driving the **state-of-the-art** in important technologies. For example, the total U.S. **supercomputer** market was just \$1.4 billion in 1988, but **supercomputers** are very important in driving a number of leading-edge technologies. DRAMs were just a \$2.5 billion market in 1987—5 percent of the total world semiconductor market—but DRAMs drive many important semiconductor manufacturing technologies. HDTV and related **HRS** are similarly driving many important technologies (ch. 5).

In contrast to American firms, many foreign competitors seem much more cautious about abandoning markets. This may be due to: the significant financial and technical skills needed

to reenter high-technology manufacturing; the potential linkages with other existing markets; or the new opportunities that being in a market may create. Being in many parallel markets can also provide economies of scale in R&D and production of the underlying components, and tends to insulate a firm from downturns in any particular market segment.

Some skeptics argue that trying to outguess the market by backing a specific product is foolish: instead of HDTVS, consumers may prefer lower-cost systems with somewhat less resolution, or systems that provide much more interactivity. This point may prove to be true. Consumer markets will likely develop around each of these as well as other applications. Neither industry nor government can guess the precise form that these markets will take; nor is it necessary to do so. There is a clear trend towards video information systems, which involve many of the underlying technologies now being most strongly driven by HDTV.

Other skeptics suggest that it doesn't matter if HDTV and related electronics products are manufactured abroad. They even speculate that it helps the American consumer if these products are dumped in U.S. markets—that this effectively gives us something for nothing. Viewed narrowly, consumers agree. Consumers want the best possible HDTV programs and pictures at the lowest possible price, and without having to pay any **subsidies**—either through taxes to support R&D, or added fees to cable companies or other distributors.

This argument is based on a questionable definition of consumer interest. If U.S. consumers are to buy these goods and maintain a high standard of living, they must have high-paying jobs in a strong economy. The United States will lose potential jobs—especially the skilled jobs needed to ensure a high standard of living in the United States—if the electronics or the displays for HDTVS and related HRSS are produced offshore. Consumers in other countries have often paid taxes and price subsidies in order to

maintain their jobs and develop their manufacturing sector.

Finally, some skeptics insist that if HDTV is potentially such a large market and so important a driver of technology, then industry would enter it. The implication is that U.S. industry's hesitation to enter indicates that HDTV is likely to be a turkey. This might prove true, yet Japanese and European industry have embraced HDTV. This difference in attitude may, in part, be due to: the history of the U.S. consumer electronics industry; the supports Japanese and European industry receive from their **governments**; and the barriers now facing prospective U.S. entrants.

U.S. industry has largely abandoned consumer electronics manufacturing. In today's color TV industry, for example, the only significant American-owned firm remaining is Zenith, which has just 14 percent of the U.S. (2.8 percent of the world) color TV market. In order to remain in the TV business, Zenith recently sold its highly profitable computer division to **Groupe Bull**, a 90 percent French Government-owned firm.¹¹ In contrast, there are currently 10 Japanese firms, 3 European firms, 2 Korean firms, and 1 Taiwanese firm producing TVs and components at some 32 locations in the United States.¹² A significant portion of this work is screwdriver assembly of electronic components and subassemblies manufactured elsewhere.

The history of the U.S. consumer electronics industry is long and tortured. Numerous factors contributed to its decline. Appendixes A and B focus on two of these many factors for the color TV industry: less-competitive manufacturing by some U.S. firms than their foreign competitors; and trade violations by foreign firms coupled with a failure of the U.S. Government to adequately protect U.S. industry. Given this

history, U.S. industry has good reason to be cautious about reentering consumer electronics.

American manufacturers face significant barriers if they are to reenter the consumer electronics industry and manufacture Advanced TVs:

- **Low Market Share**—Foreign-owned firms control the U.S. domestic TV market. Foreign competitors can and do use this base to hone their manufacturing skills, build their production and distribution infrastructure, and generate revenues for development of ATVS. This might also enable foreign firms to quickly initiate large-scale production of any **innovation** developed for the U.S. market—perhaps more quickly than the U.S. innovator.
- **Low Profits**—The U.S. TV market today provides little or no profit. Zenith, for example, has not made a full-year's profit on its television business since 1984.¹³ Few U.S. firms could justify entering such a business to their stockholders.
- **Large Capital investments**—Manufacturers must risk large **upfront** investments and withstand years of losses in order to create an ATV market. These investments are large and are increasing rapidly as manufacturing processes grow more complex. For example, capital equipment for a **minimum-efficient-scale**, state-of-the-art DRAM fabrication facility now costs perhaps \$300-\$400 million.
- **Manufacturing Skills**—Many U.S. firms lag behind foreign competitors in a number of manufacturing technologies important to the production of HDTV (ch. 5).
- **Inequities in Foreign Trade**—U.S. manufacturers may not trust the government to adequately protect them from foreign dumping; they may also have little faith that they will be able to enter or export to the

¹¹Evelyn Richards, "French to Purchase Zenith Computer Unit," *Washington Post*, Oct. 3, 1989, p. C1.

¹²Electronic Industries Association, HDTV Info Packet, and Suzanne Heaton, Electronic Industries Association, personal communication, Dec. 27, 1988.

¹³Jerry K. Pearlman, testimony at hearings before the House Subcommittee on Telecommunications and Finance, Committee on Energy and Commerce, Sept. 7, 1988.

Japanese or to export to the European ATV markets. Without being able to penetrate those markets, U.S. manufacturers may be unable to realize the same economies of scale as their foreign competitors, who can compete in the United States. Foreign producers with protected home markets can expand production with much greater confidence that it will pay off than U.S. producers who have no such assured markets for their sales.

POLICY ISSUES

U.S. industry thus faces significant barriers to entering HDTV manufacturing. Japanese firms struggled under somewhat different, but in many respects even greater, disadvantages while developing their computer industry in the 1960s and 1970s. Yet through a variety of mechanisms (app. E), they have developed world-class capabilities across the spectrum of computer technologies and products.

Developing competitive Advanced TV, consumer electronics, or HRS manufacturing industries in the United States carries many potential benefits, especially in strengthening manufacturing abilities in electronics and in developing technologies that have important spillover applications in other branches of the electronics industries. To succeed in consumer electronics, firms must meet demanding tests of manufacturing excellence: the ability to turn out reliable, well-designed goods at high volume, while keeping costs competitive. What firms learn in meeting these tests for consumer electronics can then be applied to other products, such as computers and telecommunications equipment.

Technological linkages between HDTV/HRS and other industries are equally significant. The knowledge gained in developing core technologies for these systems may sometimes provide a critical edge in competition for other markets in this fast-paced industry. U.S. firms might also find it difficult to get access on equal terms to such technologies if they are developed by

foreign competitors. For example, if a small group of like-minded foreign companies were to gain control of an important component, such as flat panel displays, U.S. firms might be vulnerable to overpricing or outright denial of sales. This is not an unheard of practice. Fujitsu, which produces both semiconductors and supercomputers, is reported to have delayed for many months in supplying critical semiconductors to the U.S. supercomputer company Cray Research, Inc.; and Nikon reportedly withheld its latest and best lithographic stepper from U.S. semiconductor manufacturers.

For the reasons outlined in the previous section, the prospects look poor for U.S.-owned firms to reenter manufacturing in the consumer electronics field. A few foreign-owned firms based in the United States are pursuing HRS research here. Possibly, with some form of government encouragement, either in developing technologies or in rebuilding manufacturing capability, or both, U.S. firms might become more interested in risking their own capital and efforts in the field as well. That possibility immediately raises the question of what exactly constitutes a U.S. firm? This question is explored below. But U.S. efforts to support ATV or HRS technologies have been fragmented and abortive so far, in part because such support raises policy issues that have not yet been resolved in public debate. This report does not attempt to resolve them either, but the following issues should be addressed if Congress wishes to pursue options to support a domestic HDTV/HRS industry.

The existence of growing international competition—and the clear decline of U.S. manufacturing competitiveness—has raised the general possibility of increased government support for industry. This makes the question of corporate nationality central. Government support should go to serve the interests of American citizens in this new global environment, but, in Robert Reich's words, "Who Is Us?"¹⁴

¹⁴Robert Reich, "Who Is Us?" *Harvard Business Review*, January-February 1990, pp. 53-62.

This question has become increasingly pressing because there have been two fundamental changes in the American economy. First, many large American firms have become global: they do an increasing proportion of their business elsewhere, and U.S.-owned firms are doing more sales, manufacturing, and even design and R&D off-shore, in markets like Japan or the EC, or in low-cost platforms like Malaysia and Thailand. Second, foreign-owned firms have diversified into the United States, and many now have substantial manufacturing efforts in the United States. Foreign-owned R&D and design facilities are also opening in the United States, and some foreign firms have acquired U.S. high-tech businesses in electronics and other industries, and support their R&D as well.

Corporate nationality is an exceedingly complex issue, and only a brief overview is possible here.¹⁵ Ownership has traditionally been the sole criterion of nationality. The fact that American firms were owned by Americans, tended to site their production in the United States, and made almost all their sales in the United States allowed the ownership criterion to represent all the other attributes of nationality. In addition, there was the unspoken assumption that American firms would in some sense act to maintain American national interests. But the shift toward off-shore production, technology development, and contracting by U.S. manufacturing firms has undercut this assumption. And ownership itself is not an unambiguous concept, as ownership does not always mean control: a minority share ownership can exercise control in some cases while a majority ownership may not be sufficient to take key decisions in others. There is little sign that U.S. firms are in fact putting the national interest before their own—

partly because that would be a breach of their fiduciary duty to their shareholders.¹⁶

Thus an alternative view of corporate nationality is now emerging, where the key criterion is the contribution of the firm to the national economy, or national competitiveness. Ownership is only one part of that contribution; not one that is easily quantified. While profits are a relatively small part of a firm's overall direct contribution to the economy in which it operates, they can be a critically important source of funding for R&D, and growth and wealth. Thus, even though their share of value is small, profits may be disproportionately important. Nor is the flow of profits clear: they can in part be recaptured by foreign firms plowing back profits into R&D or capital investments in the United States or by Americans who are fast increasing their holdings of foreign securities. The same is true for foreigners, whose increasing holdings of U.S. securities cause profits to be repatriated elsewhere.

Aside from ownership, most value created by a firm comes from research, development, manufacturing, related services, and sales. Each of these elements can be located in the United States or elsewhere, with differing contributions to the national economy. Recent testimony before Congress has stressed the importance of performance-oriented criteria for determining whether a firm qualifies as American—the extent to which the firm provides jobs, tax receipts, R&D, technology transfer, and other benefits to the United States, or contributes positively to the U.S. trade account.¹⁷

An extension of this view is offered by Reich, who argues that the critical contribution of a firm to the economy lies in its support for a world-class work force. The kind of business

¹⁵A complete analysis will be developed in the forthcoming OTA report on trade and industrial policy. This will be the third and final report of the assessment on Technology, Innovation and U.S. Trade, the first two of which were: U.S. Congress, Office of Technology Assessment, *Paying the Bill: Manufacturing and America's Trade Deficit*, OTA-ITE-390 (Washington, DC: U.S. Government Printing Office, June 1988); and U.S. Congress, Office of Technology Assessment, *Making Things Better: Competing in Manufacturing*, op. cit., footnote 1.

¹⁶Reich, op. cit., footnote 14.

¹⁷John Kline, testimony at hearings before the House Subcommittee on Science, Research and Technology, Committee on Science, Space, and Technology, and the House Subcommittee on International Scientific Cooperation Committee on Science, Space, and Technology, Nov. 1, 1989.

being conducted in the United States will have implications for the kind of work force being produced, and hence for the attractiveness of the United States as a site for high-technology, high value-added **manufacturing**.¹⁸

Some witnesses and some Representatives at the **hearing**¹⁹ also underlined the importance of reciprocity between the treatment of **foreign-owned** firms in the United States and the treatment of U.S.-owned firms in the corresponding foreign country. These comments reflected views similar to those embedded in S. 1191, the **FY 1990 appropriations bill for NIST**.

Corporate nationality becomes an extremely complex issue once the simple but perhaps outmoded criterion of ownership is abandoned. First, the various activities of **business—production, R&D, support activities, sales, trade—**must be weighed against each other. Is R&D intrinsically more valuable to the United States than an equivalent amount of value added in sales? How should quantitative criteria (e.g., a certain percentage of value added) be balanced against qualitative criteria (e.g., a commitment to doing R&D in the United States)?

These problems can be solved in principle, but practical application could be difficult. The Europeans have already found difficulties even in determining the percentage of locally produced content in some goods, and recently lost a key anti-dumping case before a GATT tribunal, partly over this issue.²⁰ Qualitative judgments are even more difficult. The combination could threaten the viability of the GATT in the future..

Finally, the complexity is compounded by the different definitional contexts. Definitions that may be appropriate for controlling foreign direct

investment may not be useful when qualifying firms for direct government support, or R&D contracts.

Despite the difficulties, nations have found ways in which to discriminate on the basis of corporate nationality. The EC is funding a number of R&D consortia. It appears that a two-tier system of discrimination maybe evolving: firms which are foreign-owned but which act as good corporate citizens (developing a fully integrated manufacturing complex with the EC, even exporting back to their country of ownership) appear to have better access to government support than foreign-owned firms which are not such good citizens. The best government support may be reserved for firms which are not foreign-owned—even though the explicit authority for such discrimination is sometimes hard to find. So far, decisions have been made case-by-case.

Advanced TV is clearly a case where the United States must play catch-up if it is to be in the game. All but one U.S.-owned company have left the business of making televisions, and the remaining company is not financially strong. The questions are whether and how to support an industry that is practically nonexistent, and where foreign producers are clearly ahead. In the past, countries that have succeeded in doing this have relied heavily on protection from foreign **competitors**—in the case of Japan, protection of domestic markets not just against imports, but in many cases from foreign direct investment as well. In Europe, which is also playing catch-up with the United States and Japan in a number of industries, the inclination against foreign firms' participation is less pervasive, especially in some countries. American and Japanese firms have been permitted to participate in some

¹⁸In Reich's article, Todd Hixon and Ranch Kimball distinguish between importers, simple screw-driver assembly (like the plants that make most consumer electronics products in the United States), plant complexes (which produce and even modify existing designs, but do not provide a full line of R&D in support of new ones), and fully integrated business operations; the latter is a relatively undefined concept which stresses tight integration of basic research, development design, and production. Reich, *op.cit.*, footnote 14.

¹⁹Hearings before the House Subcommittee on Science, Research and Technology, Committee on Science, Space, and Technology, and the House Subcommittee in International Scientific Cooperation Committee on Science, Space, and Technology, "What is a U.S. Company?" Nov. 1, 1989.

²⁰William Dullforce, "Japan Scores Victory over EC on Duties," *Financial Times*, Mar. 29, 1990; Peter Montagnon and Lucy Kellaway, "EC Refuses To Adopt GATT Report on Dumping," *Financial Times*, Apr. 4 1990.

EC-funded R&D programs, and foreign investment is now encouraged, especially in industries like electronics and motor vehicles. Nonetheless, domestically owned firms still seem to be favored for access to government- and EC-funded programs aimed at hastening technical development.

The European and American governments face different problems in HDTV; Europe still has a domestic, European-owned consumer electronics manufacturing industry. There are companies that produce televisions, many of them with production and even research facilities in the United States. Most are foreign-owned. Sony, Philips N. A., and Thomson are involved in ATV, and would probably be willing and able to take advantage of any government-supported program to foster HRS technology development. Once again, that raises the question of what criteria the U.S. Government would establish to determine the participation of companies.

The interests of firms and the interests of nations are not always the same. American firms, like European and Japanese firms, are increasingly likely to be involved in a variety of international cooperative agreements with other firms. Multinational firms have many choices of where they will perform R&D and manufacturing. Right now, the United States is not an attractive location for developing and manufacturing televisions and other consumer electronics products, except for foreign-owned firms with external sources of capital and other advantages stemming from foreign bases of operation. To generate interest among domestic firms in reentering the business of developing and making televisions, the government probably will need to change the rules for operating here, including altering the capital and investment market for manufacturing in the United States.

In the long run, the most promising way of assuring that domestic efforts to support any new technology will result in domestic value added, is to make the United States a more attractive location for manufacturing. The United States now has disadvantages in cost compared with many developing nations, and disadvantages in its financial environment and quality of human resources compared with many advanced nations, including Japan and much of the EC. In addition, the EC and Japan, among others, have substantial government programs to support new technology development and diffusion of manufacturing technology. The United States compares poorly here, too. Improvements in these areas will help to ensure that any government support of new technologies or infant industries are more likely to lead to domestic development and manufacturing.

NATIONAL SECURITY

High Resolution Systems (HRS) and related technologies are likely to play an important role in future military systems—analyzing the battlefield, targetting the enemy, or parrying the enemy's attack could all benefit from high-quality, real-time video information (see box 1-1). HRS technologies will, however, probably be driven primarily by the needs of the commercial sector.

The defense strategy of the United States has long relied on technologically superior weapons to overcome numerically superior foes. Electronic technologies are a critical element in this strategy. The broad loss of U.S. leadership in semiconductor and other electronics technologies, particularly in their manufacture, raises significant concerns for U.S. defense capabilities in the future.²¹

Dependence on foreign-sourced technologies generates risks to the U.S. defense posture: supply lines might be disrupted during a crisis;

²¹Office of the Under Secretary of Defense for Acquisition "Report of Defense Science Board Task Force on Defense Semiconductor Dependency, February 1987; U.S. Congress, Office of Technology Assessment, *The Defense Technology Base: Introduction and Overview*, OTA-ISC-374 (Washington, DC: U.S. Government Printing Office, March 1988); U.S. Congress, Office of Technology Assessment *Holding the Edge: Maintaining the Defense Technology Base*, OTA-ISC-420 (Washington, DC: U.S. Government Printing Office, April 1989).

a supplier might withhold critical components due to pressure from adversaries; or an adversary might gain access to critical technologies more easily if they are foreign- rather than U. S.-sourced. For example, the Soviet Union was able to purchase a sophisticated milling machine from Toshiba (Japan) and Kongsberg (Norway) in 1987. This technology enabled the Soviets to construct much quieter propellers for their submarines and has thus greatly reduced their detectability.

Foreign suppliers might also judge their commercial interests as more important than U.S. security interests. For example, they might withhold state-of-the-art technologies that the United States needs for defense applications in order to gain a commercial edge. Such withholding may already occur in the commercial sector for semiconductor manufacturing equipment and certain computer chips, among others.

On the other hand, the performance attainable by U.S. weapon systems maybe reduced in the absence of the best available technology, some of which is commercially available from our allies. It may also be more expensive to procure systems solely from domestic sources rather than from lower cost foreign sources.

The defense market is no longer large enough to drive the development of many electronics technologies. In 1987, the Defense Science Board Task Force on Semiconductor Dependency found that, in contrast to the 1950s and 1960s, DoD procurement of semiconductors was too small compared to civilian markets to be of much importance to the overall semiconductor industry: It concluded, however, that a healthy semiconductor industry was critical to national defense. Defense applications may also lag far behind the state-of-the-art due to the long procurement times. The same point could be made about many other electronics technologies, from components to computers, and is likely to be the case for HRS technologies as well.

The Defense Advanced Research Projects Agency (DARPA) is supporting generic R&D in HRS displays and display electronics (ch. 2), but it will not be able to leverage more than a small fraction of the R&D that would be conducted by a viable civilian HDTV/HRS industry. Further, DoD and DARPA do not have the legislative authority to directly promote a civilian HDTV/HRS industry.

A strong civilian HRS technology base is necessary if many HRS technologies are to be available for defense needs at all. The low costs realized for HRS technologies in the commercial sector, however, will not be automatically translated into low-cost HRS for defense applications. The complexity and specialized nature of defense systems results in long product cycles, high R&D and engineering costs, and stringent performance and reliability criteria that may have little relationship to commercial needs—such as for electronics that can withstand high levels of radiation. Further engineering development of commercially ‘available components is often necessary; and even when commercial components can be used, they are often just a small fraction of the total system cost. Byzantine procurement practices also keep costs high.²²

THE COMMUNICATIONS INFRASTRUCTURE

HDTV could involve much of the U.S. communications infrastructure—terrestrial, cable, and satellite broadcasting; mobile communications; and potentially even the telephone companies. The current terrestrial broadcast spectrum allocation and transmission standards have been in place for nearly 40 years. Accommodating the larger information content of an HDTV-quality picture could force changes in the frequency allocation and more efficient use of the spectrum. These changes would also have conversion costs and create competitive tensions among the media. HDTV opens new opportuni-

²²“Special Issue: The Price for Might,” *IEEE Spectrum*, November 1988; U.S. Congress, Office of Technology Assessment, *Holding the Edge: Maintaining the Defense Technology Base*, op. cit., footnote 21.

ties to develop standards and systems that allow for an easy and flexible transition to future communications systems such as interactive high-resolution video on optical fiber.

Recorded Media

HDTV might be first introduced into the U.S. market through recorded media such as HD-VCR tapes, which are not subject to FCC regulation. The sale of HDTV-quality videotapes and associated consumer electronics equipment might create a market that would then define a de facto standard for all U.S. media, whether optimal or not.

HD-VCRs may not require data compression to the extent needed for terrestrial broadcasting. This would allow HD-VCR producers to set higher quality standards than might be practical for terrestrial broadcasters or cable operators. In the longer term, wider bandwidths might continue to provide HD-VCRs or other recorded media a competitive advantage over broadcast media—able, terrestrial, satellite—for certain types of programming.

Terrestrial Broadcasters

HDTV could dramatically impact terrestrial broadcasting. A 1988 FCC study found that with the current geographical limits and channel separation requirements,²³ increasing the TV channel width 50 percent (several of the HDTV proposals would require greater bandwidth than this) might force a quarter of today's TV stations off the air.²⁴

Policymakers could use the introduction of HDTV as an opportunity to reexamine the entire question of spectrum allocation for the first time since the current system was defined in 1952.²⁵

The standards and frequency allocations made in the early days of TV broadcasting were intended to keep the cost of receivers within reach of the mass market by using then current technology. There was little need then to conserve the spectrum.

Technological advances since 1952 allow more efficient use of the spectrum at little additional cost, permitting more channels of higher quality to be packed into less space. The spectrum saved can be used for other services, such as mobile communications.²⁶

The FCC could choose an *augmentation* policy that would minimize the impact HDTV technologies have on spectrum use. Existing broadcasters would be granted a 3- or 6-MHz chunk of spectrum—most likely one of the “taboo channels” (one left vacant by regulation to reduce interference between local stations)—in addition to their existing 6-MHz NTSC channel in order to transmit the added information that HDTV needs to create a high-quality picture. If a taboo channel was unavailable, then a noncontiguous channel would be used. The wider the frequency separation between the main NTSC channel and the augmentation channel, the more likely they would suffer different types and amounts of distortion—making it difficult to meld the two signals seamlessly into one picture.

Systems that augment NTSC broadcasts would tend to lock in the same inefficiencies of the NTSC technology that currently hamper the industry (ch. 4). This might prevent the development of additional broadcast TV channels or prevent other uses of this spectrum.

²³Geographic limits require roughly 50 mile separation if the stations are transmitting over adjacent channels, 150 to 200 miles separation if transmitting over the same channel. UHF channel separation is typically one blank channel between active stations in the same geographic area; and five blank channels between active stations in the same geographic area for VHF. Channel separation requirements are given in more detail in 47 CFR 73.609; 47 CFR 73.610.

²⁴“A High-Tech, High Stakes HDTV Gamble,” *Editorial Research Reports*, vol. 1, No. 7, 1989.

²⁵Sixth Report and Order, Television Allocations, 41 FCC 167 (1952). The NTIA has begun a major project to reassess the allocation of radio frequency spectrum. Kathleen Killete, “New NTIA Chief Tackles Agenda,” *Multichannel News*, Aug. 28, 1989, p. 34.

²⁶Dale N. Hatfield and Gene G. Ax, “The Opportunity Costs of Spectrum Allocated to Hi-Definition Television,” paper presented at the 16th annual Arlie House Telecommunications Policy Research Conference, Arlie, VA, Oct. 30, 1988.

A *simulcast policy* would have a much greater long-term impact than augmentation, depending on how it was implemented. The simulcast signals would not have to be compatible with existing **NTSC** standards and would require few if any taboo channels; a new set of standards could be adopted for them that would permit closer spacing of the new stations' channel assignments. As the penetration of HDTV sets increased, the **NTSC** stations might be phased out and the freed spectrum used for: 1) a next generation of even higher quality video broadcasting technology; 2) additional new TV stations; or 3) mobile communications or other services.

Cable Television

The possibly wider bandwidth of HDTV broadcasts might require cable operators to use more fiber-optic technology or perhaps lease portions of the telephone companies' fiber-optic networks. Cable operators may also consider using **DBS** to supplement cable systems.

A system using a cable company's coaxial cable and a telephone company's twisted copper pairs might be able to provide a reasonable level of interactive video services in the midterm (ch. 3). Existing coaxial systems can provide HDTV-quality programming, particularly when strengthened with a fiber optic backbone. Existing twisted copper pairs of the telephone network will be able to provide a data rate sufficient for most information services—but not moderate-to-high-definition real-time video—within the planned upgrades to the N-ISDN level of service.

Direct Broadcast Satellites

Direct Broadcast Satellites use frequencies too high to be of practical use to earthbound broadcasters; there is a relatively broad range of frequencies available; and satellite broadcasters have not yet developed strong vested interests in a particular allocation of these radio frequency

bands although competition for geosynchronous orbital space is keen. It is therefore easier to adjust the satellite transmission system to meet the demands of HDTV. A partnership was recently formed in the United States to establish a **DBS** system by as early as 1993.²⁷ Some analysts believe that a **DBS** system could "cherry-pick" the most lucrative HDTV opportunities and poses a formidable threat to **cable-based** or other delivery systems.²⁸

Mobile Communications

The potential benefits of using additional spectrum for HDTV broadcasting must be balanced against the benefits of using portions of the TV spectrum for other purposes such as mobile communications. Due to the physics of radio wave propagation in the atmosphere, the most desirable frequencies for mobile communications are the same as those now used for TV. When the current TV broadcasting system was put into place and the channels allocated in the 1940s and early 1950s, there was no competition for these frequencies from alternative uses; nor did alternative distribution systems for **TV**—such as cable or **satellite**—**exist**. Today, there are many alternate means for distributing TV; the choices for mobile communications are more limited.

HDTV could have an enormous impact on mobile communications such as cellular telephone, paging services, and related systems. More spectrum might be made available for these services during the transition to HDTV if simulcast standards are used and channels are repacked. In the longer term, additional spectrum might also become available if terrestrial broadcasters were unable to provide as high-quality pictures as competitors—which could cause their viewing audience to shift to **alternative** services and allow these frequencies to be reallocated to other uses.

Additional spectrum for land mobile services could help reduce future congestion on mobile

²⁷John Burgess, "Satellite Partnership Plans Pay-TV System," *Washington Post*, Feb. 22, 1990, p. E1.

²⁸David Rosen, "The Market for Broadband Services via Fiber to the Home," *Telematics*, vol. 6, No. 5, May 1989.

frequencies, particularly during rush hours in cities like Los Angeles, New York, and Washington, D.C. Spectrum and digital radio technologies might allow economical and portable personal communications to be made available to most individuals. With sufficient spectrum, cellular systems might someday compete effectively with local telephone companies wire-line systems.²⁹ Rates for telephone services might then be left to the competitive market the way that cellular rates are now.

To develop a widely available personal communications network, however, will require more spectrum than is currently available. Although the United States is still a leader in mobile communications technologies, it could falter unless the industry can gain similar access to spectrum and, correspondingly, achieve similar market scales as its competitors in foreign markets.

Telephone Companies

Twisted copper-pair will continue to be the predominant medium in the local loop for the next 10 to 20 years. With the transition to N-ISDN (ch. 3), the existing copper-pair network will be able to handle most information needs, including voice, data, and even some low- to moderate-quality video. Over the mid-term, mixed telephone/copper pair and cable TV/coaxial cable networks might provide a medium level of interactive information services: cable could provide a high flow of information (hundreds of **Mbps**), including high-quality video, from a central location to the home; and copper pairs could transmit data at a rate of 1.5 **Mbps** (two pair) from the home to any other point desired through the switched network of the public phone system.

Fiber is likely to be the medium of choice throughout the cable and telephone networks in the longer term. Inserting fiber in the cable backbone as a first step significantly improves

cable capacity and performance for a relatively small investment. In contrast, although telephone companies can replace their backbones for roughly the same cost as cable companies, the copper pairs in the local telephone loop to the home do not have sufficient capacity to deliver a high-definition signal.

Cable systems **cannot** easily be adapted to provide high-capacity switched two-way communications such as the public phone system does. Regulatory and financial structures may hamper a move to such a system.³⁰ An **important** question confronting **policymakers** is whether a mixed cable/telephone network is an important intermediate step toward a national two-way broadband network or an evolutionary **dead-end**. If the former, changes in the regulatory environment to aid this transition would be necessary; if the latter, means of encouraging a direct transition to a national broadband network must be considered.

Market Share

Terrestrial broadcasters (as do all spectrum users) have limited spectrum available to them; in turn, this limits the quality of the pictures they are able to deliver to viewers. If terrestrial broadcasters cannot deliver pictures of as high quality as cable or **DBS** broadcasters, they may lose market share. Because of this, many U.S. terrestrial broadcasters want a single uniform transmission standard applied to all broadcast media—terrestrial, cable, **DBS**, **VCRs**—to limit all media to the same technical capability as terrestrial broadcasters.

Conversely, many of the competing media look to HDTV as an opportunity for them to capture market share from terrestrial broadcasters by use of their greater technical **potential** and flexibility to transmit high-quality HDTV to the consumer. Terrestrial broadcasters have little to gain and a lot to lose in such a contest: they currently have between 54 and 59 percent of the

²⁹Hatfield and AX, op. cit., footnote 26.

³⁰Bruce L. Egan and Douglas A. Conn, "Capital Budgeting Alternatives For Residential Broadband Networks," Center for Telecommunications and Information Studies, Columbia University, 1989.

television audience, and TV households watch programs more than 7 hours/day.³¹

There is more at stake in the contest for market share among the various media than simply profits: it could overturn the traditional roles that these media have played in serving the public. Broadcast TV is a central cultural focus in American life, providing a shared experience and information for **all**. Over-the-air broadcasters are the only ones to be required by a statutory obligation to serve local audiences—providing news, local election coverage, public **announcements**, and community affairs. Similarly, public broadcasting stations are major providers of educational programming. Because of these roles and the lack of similar regulatory demands on alternative media, there is concern that if broadcasters are unable to provide the same quality service as alternative media, these services could be lost. While market forces will ensure the provision of acceptable TV programming, Congress may need to take steps to ensure comparable **services**—news, community affairs, etc.—will be fully and equitably provided to the public by each medium.

costs

The costs of upgrading to HDTV for program producers, broadcasters, and consumers could be substantial, depending on the standard chosen. Program producers will need to convert existing studio equipment to video HDTV production equipment, but this may reduce production costs by eliminating delays in processing film and by facilitating editing and incorporation of special effects in the production process.

Estimates of the cost of upgrading terrestrial broadcaster's NTSC equipment to HDTV capa-

bility range from \$7.4 million to \$40 **million**.³² A simulcast system might cost less than one using augmentation channels, because much of the existing transmission equipment could be used (except for the digital coding, and it would not necessarily require new wide-band equipment) and the transmission power requirements would be much **less**.³³

Costs for cable companies may be less. The FCC Advisory Committee has estimated that the extra cost of introducing 12 channels of HDTV programming on a sample cable system serving 100,000 subscribers would be about \$1.9 **million**.³⁴

Consumers, too, may find HDTV receivers more expensive than the set they use now. By upgrading to HDTV at the time they would normally replace their old set, these costs could be blunted somewhat.

Finally, if the HDTV system is more spectrum efficient, these costs must be weighed against the benefits of freeing valuable spectrum for other uses. Consumers **cannot** make this trade-off, however; **policymakers** must.

The chicken-and-egg problem of who invests first might only be resolved by all acting in concert. Color TV was successfully introduced only through the patience and enormous investment—some \$3 billion in 1988 dollars—of RCA.³⁵ A similar risk will have to be borne to launch HDTV. On the other hand, UHF broadcasting was made possible by government action through the “All Channel Receiver Law” which requires all TV sets sold in the

³¹A.C. Nielson Co., personal communication October 1989.

³²FCC ATV Advisory Committee, Systems Subcommittee, Working Party 3 *Terrestrial Specialist Group 1*, “Interim Report,” table 1, Apr. 10, 1989. The Boston Consulting Group, “Development of a U.S. Base ATV Industry,” Preliminary Report prepared for the American Electronics Association 1989, p. 22.

³³Howard Miller, “The Simulcast Strategy for HDTV,” *PBS*, 1989.

³⁴FCC ATV Advisory Committee, op. cit., footnote 32, attachment E, table 2; and Boston Consulting Group, op. cit., footnote 32.

³⁵U.S. Congress, House Subcommittee on Telecommunications and Finance, Committee on Energy and Commerce, *Consortia and the Development of High Definition Systems*, testimony presented by Barry Whalen, Sept. 13, 1988.

United States to have both VHF and UHF tuners.³⁶ This prevented manufacturers from cutting costs by eliminating the UHF tuner—thus raising costs to consumers slightly—but over time allowed the development of a sufficient market so that UHF broadcasting could be successfully launched.

THE STANDARDS-SETTING PROCESS

Standards can reduce or prevent confusion in the marketplace. Standards allow manufacturers to increase production efficiency by producing in large volumes for a uniform market; they can stimulate competition; and they reassure consumers that whichever brand of HDTV they buy or wherever they use it in the United States, it will be able to receive and display the local broadcasts.

These lessons have been hard learned. After unsuccessful attempts to set AM stereo radio standards, for example, the FCC left the decision to the “marketplace” in 1982.³⁷ Several incompatible systems then began to be adopted; this increased consumer, broadcaster, and manufacturer confusion. As a result, AM stereo broadcasting is growing very slowly, and AM radio generally is losing market share to FM radio.

Standards sometimes have drawbacks as well. When a technology is rapidly changing, standards can lock in an obsolete technology; standards can limit choice; and if poorly designed yet widely used, standards can slow

innovation.³⁸ A good example might be the QWERTY typewriter. Designed in the late 1800s, the QWERTY layout was intended to limit typing speeds; the mechanical systems then available could not otherwise keep up with a fast typist and tended to jam. Since then, however, this keyboard has proven impossible to dislodge despite its widely acknowledged shortcomings.

Standards have also been used to promote national political and/or commercial interests. Rather than using the U.S. NTSC system, France developed and adopted its own color TV standard, SECAM, in the early 1960s in order to protect its color TV industry during the developmental stages. By 1976, the French TV industry accounted for roughly 0.5 percent of the French GNP.³⁹ Similarly, patents on the German color TV system, PAL, were used to help exclude non-European manufacturers from the European market.⁴⁰

In the United States, technical standards for domestic communication technologies are currently handled almost exclusively by the FCC. Not only has Congress granted the agency virtually sole jurisdiction over broadcasting standards,⁴¹ but the courts have also recognized that its legislative authority permits the agency to preempt conflicting State or local regulations of technical standards in telephone⁴² or cable television.⁴³ Where the courts have found that national uniformity is important to foster interstate commerce, they have prevented States from establishing differing standards.

³⁶47 CFR Section 15.65.

³⁷Stanley M. Besen and Leland L. Johnson, *Compatibility Standards, Competition, and Innovation in the Broadcasting Industry* (SW@ Monica, CA: Rand Corp., November 1986). Note that the FCC faced several difficulties in setting this standard, including incomplete information on the performance of different systems, conflicting test data or data that was gathered under differing conditions, and fierce opposition from the firms that would have lost had the tentative FCC findings been formalized.

³⁸David Hack, Library of Congress, Congressional Research Service, “Telecommunications and Information Systems Standardization—Is America Ready,” 87-458 SPR, May 21, 1987.

³⁹Rhonda J. Crane, *The Politics of International Standards: France and the Color TV War* (Norwood, NJ: Ablex Publishing Corp., 1979).

⁴⁰Trade policy may have played a more important role in keeping imports out.

⁴¹See, e.g., *Gagliardo v. United States*, 366 F.2d 720, 723 (9th Cir. 1966).

⁴²*North Carolina Utilities Commission v. FCC*, 537 F.2d 787 (4th Cir. 1976) upholding the FCC’s standards for customer premises equipment (CPE).

⁴³*City of New York v. FCC*, 108 S.Ct. 1637 (1988).

The manner in which the FCC administers this power can have a significant impact on many areas of telecommunications; thus the nature of the *ATV* standards-setting process could strongly influence who benefits and who loses from those decisions. Four aspects of the process appear to have particularly important impacts within the United States itself: 1) how much discretion is delegated to the marketplace; 2) how fast the process is pushed; 3) whether all serious proposals are fully considered; and 4) whether the process permits the selection of a standard that combines aspects of different proposals. An important related issue is U.S. participation in international standards fora; this complex issue will be discussed elsewhere.

Standards Setting and Marketplace Participants

Ideally, the participants in a market would reach a consensus on the best standards to adopt for a particular product, that maximizes their profits at the same time that they maximize the attractiveness of the product to the public. Private sector firms have the technical expertise and the best knowledge of the markets; and they are financially accountable for their errors. The marketplace, however, provides many incentives for firms to establish standards unrelated to social benefit.

The FCC Advisory Committee on Advanced Television Services provides a mechanism for the direct input of private firm expertise. This advisory committee is voluntary and open to all who wish to participate. Most of those who currently participate represent manufacturing or media interests—they can't afford not to participate. In contrast, representatives of labor and consumer interests face difficulties in participating.

Private sector firms directly influence the standards-setting process by providing regular and extensive technical staff participation to the committee; by conducting independent and/or supporting studies; and by widely distributing technical documentation. These are potentially valuable inputs and are incorporated in FCC

decisionmaking. Yet there is also the potential for abuse. Large firms may be able to fund more staff participation and technical inputs than those with limited resources. This can bias the process.

Foreign TV manufacturers, for example, may be able to channel much greater resources into the standards-setting process than U.S. TV manufacturers, since they now dominate the U.S. television market. The standards promoted by foreign manufacturers will not necessarily represent U.S. national interests in developing domestic communications infrastructure; these standards almost certainly do not represent U.S. national interests in encouraging additional U.S. firms to reenter *ATV* manufacturing. Foreign governments often do not allow reciprocal access by U.S. firms to their standards-setting processes for similar reasons.

U.S. broadcasters might oppose standards that would make it easier for the FCC to reallocate portions of terrestrial broadcasting spectrum to other purposes in the future, regardless of the long-term interests of the public in mobile communications or other services.

Finally, if market participants are unable to reach a consensus on a single choice, there is danger that multiple and incompatible standards could result. This could raise uncertainty among manufacturers and consumers and hinder the introduction of *ATV*.

The Timetable for Establishing Standards

In responding to the array of issues raised by *HDTV* there are two conflicting time pressures: 1) taking the necessary time to establish a flexible standard that can support the rapidly changing technologies and needs for the next several decades; and 2) setting standards quickly enough that the U.S. market can grow in parallel with those in Europe and Japan, thus providing U.S. producers similar opportunities for realizing economies of scale and learning in production.

If the United States acts precipitously and establishes standards prematurely, the *ATV*

equipment produced under those standards might quickly become obsolete, the Nation might have to endure with inferior technology, or have excessive difficulties in making the transition to future generations of equipment.

Alternatively, if potential U.S. entrants wait for a national fiber system, for example, before entering the ATV market, they could wait 20 years or more. During that time, foreign competitors would have the opportunity to further strengthen their manufacturing capabilities and distribution systems, and would receive enormous revenues for conducting R&D into new technologies. If additional U.S.-owned or U.S.-based firms are to enter these markets, there is no substitute for getting in quickly and gaining intense day-to-day manufacturing experience.

Providing Full Opportunities for All Serious Proponents

Without some minimum threshold for those seeking to establish ATV standards, the FCC could be subject to numerous quack proposals submitted in the misguided hope of winning a standards "lottery." Indeed, at least one of the proposals submitted on paper was believed to "challenge the known laws of information theory."⁴⁴ The FCC Advisory Committee currently requires standards proponents to submit a fully developed set of broadcasting and reception hardware to the Advanced TV Test Center (ATTC) for testing;⁴⁵ and the ATTC in turn requires the proponent to post a \$200,000 bond to hold a time slot for testing their system (this bond can be waived). On its face, this makes sense. The FCC should not spend government money to develop and test a private group's system, particularly if all the royalties go to that private group.

On the other hand, designing and building a complete set of hardware can cost several million dollars; buying test equipment to debug the hardware before presenting it to the ATTC can cost millions more. Even fairly large firms, such as Zenith, are straining to find the manpower and financial resources to meet these demands. It is not surprising, then, that other U.S. proponents, who are generally small, entrepreneurial or university-based efforts, are having even greater problems. Of the more than 20 standards proposals submitted to the FCC, only 5 or 6 appear likely to be developed into hardware at this time due in part to the lack of financial resources. Several of these are of EDTV-rather than of HDTV-quality and all but one or two are sponsored by foreign-based manufacturers. Even the FCC Advisory Committee has obliquely noted this problem.⁴⁶

It is not entirely clear why the U.S. capital markets have failed to provide the necessary financing, but they have not. If financial support is not forthcoming there is the risk that a foreign-owned standard will be selected and potentially hundreds of millions of dollars in license royalties will flow to that entity, despite the possibility of a superior U.S.-owned system that could not be considered for lack of a few million dollars in timely funding.

This early focus on hardware may also be counterproductive for other reasons. Today, complex systems are always simulated on a computer before they are produced. For HDTV this is particularly important because many of the improvements in hardware that can be expected in coming years should be assessed, but the technologies themselves are not and will not be available for years. For example, it may be useful to develop a broader set of standards that allows for the gradual upgrading of ATV to

⁴⁴FCC Advisory Committee on ATV, Systems Subcommittee, "Interim Report," Apr. 10, 1989, SS/WPI Interim Progress Report, Feb. 12, 1989.

⁴⁵Richard E. Wiley, "Second Interim Report of the FCC Advisory Committee on Advanced Television Service," Apr. 26, 1989.

⁴⁶'FCC Advisory Committee on Advanced Television Service,' Systems Subcommittee, "InterimRepO%" Apr. 10, 1989; "An Assessment of the ATV Systems and Technologies Presented at the Nov. 14-18 Meeting of SS/WPI," p. 3. "MIT has provided outstanding technical information ranging from technical papers on psychophysical aspects of television to ATV system proposals. At the "marathon" meeting MIT presented very interesting results from computer simulation studies on ATV transmission in low quality analog channels . . . [but] MIT . . . has declined to submit hardware for testing."

a fiber system, or that can handle the differing requirements of commercial or industrial users.

The standards process is already falling behind schedule. This is due, in part, to the rapid evolution of the technology and the difficulty of developing a broadcast standard for HDTV—which many groups are beginning to more fully appreciate. Ultimately, of course, any proposed standard must be proven in full-scale tests with real hardware before it can be formally adopted. Full-scale manufacturing and marketing will require a firm with enormous financial resources and skilled manpower.

Hybrid Standards

The current requirement that proponents provide their own hardware combined with the FCC's limited technical and financial resources for designing and testing ATV systems may hinder the synthesis of a standard from the best features of several proposals. Proponents of particular standards might also object to such a synthesis, gambling instead for their proposal to be chosen exclusively.

In Europe and Japan the governments have maintained extensive staff experience through their national telecommunications services and broadcasting organizations. Raising the level of technical manpower and financial resources within the FCC and possibly utilizing the expertise within universities and National Labo-

ratories, including the U.S. Department of Commerce's National Institute of Science and Technology (NIST), might enable the government to play a greater role in protecting U.S. national interests and reduce U.S. reliance on foreign industry groups with potentially conflicting agendas.

Alternatively, a small elite group of industry and university technical experts might be formed and funded to work together, or in parallel, to synthesize the best possible standard from the numerous competing proposals. A corresponding patent pool might be formed with appropriate safeguards for the interests of the individuals and companies involved and to pay back the government its investment from royalties. Some portion of these patent pool royalties might also be used to fund R&D in video entertainment technologies, ranging from camera to broadcasting to receiver display technologies.

Royalties to RCA similarly supported a significant fraction of the R&D in consumer electronics done in the United States. RCA was established by GE, Westinghouse, and AT&T in 1919 at the request of high U.S. Government officials (including the Acting Secretary of the Navy, Franklin D. Roosevelt) who wished to prevent foreign domination of the growing transatlantic communications services.⁴⁷

⁴⁷Undersea cables were already under foreign (if friendly) control. In contrast, the 'wireless' stations of British owned American Marconi Company had been held by the U.S. Government during WWI for wartime purposes. Rather than return these stations to foreign control, RCA was formed and these stations were transferred to it in 1920. RCA Corp. "RCA: Unhistorical Perspective," 1978. For a discussion of the development and fate of RCA, See: "The U.S. Television Set Market, Prewar to 1970"; Donald Christiansen, "A Stirring Giant," *IEEE Spectrum*, February 1986; Nhora Cortes-Comerer, "A Venerable Giant Sharpens its Claws," *IEEE Spectrum*, February 1986; Herb Brody, "Picking Up The Pieces of RCA," *High Technology Business*, May 1988.

The Historical Development of HDTV

INTRODUCTION

Japan is currently the world leader in HDTV development. Sony began selling HDTV studio production equipment in 1984 and HDTV receivers are now being sold commercially. Regular satellite broadcasts in Japan began in June 1989 and, by 1991, **NHK** (the state-owned Japan Broadcasting Corporation) plans to broadcast 6 to 7 hours of HDTV programming daily.

Driven by the threat of Japanese domination of European consumer electronics markets, industry in 19 European countries initiated **Eureka 95** in 1986—a collaborative crash HDTV development effort—that has made rapid progress in developing a European HDTV system. They have since demonstrated numerous pieces of production, transmission, and reception equipment and they plan to begin Extended Definition ED-MAC broadcasts in 1991.

U.S. electronics manufacturers have a significant set of handicaps as they move to meet the competition. U.S. broadcast standards are not scheduled to be established until 1992. U. S.-manufactured HDTV consumer equipment probably could not be commercially available until 1993 or 1994. U.S. manufacturers are running a distant third in a three-way race.

This chapter addresses the history of HDTV development. By far the most detail is provided on

Japan's efforts because of their magnitude and complexity. The HDTV work in the United States and Europe will be briefly examined here.

JAPAN¹

NHK researchers began investigating HDTV following the 1964 **Tokyo** Olympics. A formal research program was begun in 1970. In 1972, **NHK** proposed an HDTV research program to the **CCIR** (the Consultative Committee on **International Radio**).² Development of techniques for program production and to make broadcasting practical followed. In 1979, **NHK** began experimental transmission tests.³

Sony began marketing HDTV studio production equipment in 1984 and introduced a second generation of HDTV studio equipment in 1989.⁴ **NHK** experimentally broadcast HDTV pictures of the Seoul Olympic Games in 1988 via optical fibers and satellite, and began daily 1-hour experimental HDTV broadcasts in June 1989 using satellite BS-2. Limited HDTV "HiVision" satellite broadcasts are scheduled to begin in 1990 using the **BS-3A** satellite; regular broadcasts will begin in 1991 with **BS-3B**.⁵

At the same time, Japanese TV manufacturers have developed Improved Definition TVs (**IDTV**) which use digital electronics to improve the picture attainable with current NTSC broadcasts. In August 1989, private Japanese Broadcasters began **terres-**

¹The principal sources for this section are: James G. Parker and E. Jan Vardaman, "HDTV Developments in Japan," TechSearch International, Inc., Austin, TX, 1989; Mark Eaton, MCC, personal communications, Austin, TX, May 11, 1989, Oct. 12, 17, and 18, 1989; and Pamela Doughman and Mark Eaton, "HDS Projects and Developments in Europe and Japan," unpublished manuscript, MCC, Austin, TX, August 1988; See also: Takao Shimizu, "High Definition Television: Comparison of Research and Development Strategies," M.Sc. Thesis, Sloan School, Massachusetts Institute of Technology, May 1989; Chalmers Johnson, "MITI, MPT, and the Telecom Wars: How Japan Makes Policy for High Technology," in *Politics and Productivity: The Real Story of Why Japan Works*, Chalmers Johnson, Laura D'Andrea Tyson, John Zysman (Cambridge, MA: Ballinger Publishing, 1989); Robert B. Cohen, "A Profile of Japan's HDTV Industry, Its Links to Other Sectors, and Policies Adopted to Promote HDTV Development" for the JTEC Panel Report, National Academy of Sciences, draft.

²The CCIR is an organization involved with international telecommunications standards setting. It is associated with the International Telecommunications Union and chartered under the United Nations. ThITU was founded in 1865 and has been a United Nations organization since 1947. Currently 160 members strong and headquartered in Geneva, Switzerland, it is the supreme international organization dealing with issues of telecommunications and standards setting. For more information see: George A. Coddling, *The International Telecommunications Union in a Changing World* (Dedham, MA: Artech House, 1982).

³Kenneth R. Donow, "HDTV: Pleading for Action," National Association of Broadcasters, Washington, DC, April 1988. Note that these early tests were wideband—Birney Dayton, NVision, personal communication Oct. 12, 1989; William Schreiber, Massachusetts Institute of Technology, personal communication Oct. 12, 1989.

⁴"Super Television" *Business Week*, Jan. 30, 1989; "Development of MUSE Family Systems," **NHK**, Nov. 15, 1988, mimeo; David Sanger, "Japanese Test Illustrates Big Lead in TV of Future," *New York Times*, Mar. 21, 1989; and, Larry Thorpe, Sony Corp., personal communication Oct. 12, 1989.

⁵Parker and Vardaman, op. cit., footnote 1; Eaton, op. cit., footnote 1.

trial broadcasts of an **NTSC** compatible **Extended Definition TV (EDTV)** System known as “**ClearVision**” in the Tokyo and Osaka area. Later phases of this project will provide a wider screen picture and add *digital soundtracks*.⁶

The Japanese may not have begun their quest for HDTV in the 1960s with anything more in mind than high-quality pictures and the prospects offered by large consumer electronics markets. Beginning in 1983 with the emergence of the “teletopia”⁷ concept, HDTV became something more than that—an integral part of their information society of the future. The Japanese envision not a service economy but an information economy with more and higher value-added manufacturing than today. By the year 2000, the Japanese expect **fully** one-third of their industrial investment to be in manufacturing related to information technologies and **products**.⁸

In developing such an economy, several principles are shaping their policies, including: “technology fusion,”⁹ or the potential of a technology to impact a broad range of other technologies and industries; sharing risk between companies and the government; the promotion of consortia designed to stimulate competitiveness; and the importance of developing mutually supporting markets.

Within this framework, the Japanese Government is providing an intricate web of direct and indirect supports for the development of HDTV. In addition, the government has worked with industry to establish standards and has aggressively promoted these standards and Japanese commercial interests worldwide.

Research and Development

The Japanese Government performed the initial high-risk R&D for an HDTV system under the umbrella of the state-owned **NHK**. Once the major system parameters were developed, **NHK** “encouraged” equipment suppliers to participate in the

development of the system components. Companies were assigned **specific** research areas and sometimes even specific production tasks, the results of which were shared with **NHK** and the other **participating** companies for at most a nominal licensing fee.

NHK divided the development of specialized integrated circuits (**ASICs**) for the MUSE HDTV receiver, for example, among six different companies to avoid the duplication of effort and cost if each **firm** had to design a complete set of **ASICs** itself. Thus, Toshiba developed motion compensation chips; NEC developed color signal processing chips; Matsushita developed audio processing chips; and so on.¹⁰ Similarly, **MUSE to NTSC converter chip** set development was divided between Sanyo, Mitsubishi, and Matsushita. These designs were then shared by all participants.

Numerous **firms** are involved in other joint (or perhaps more accurately described as partitioned) R&D efforts on HDTV-related technologies that are coordinated by **NHK**, **MITI**, **MPT**, or the Key Technology Center.¹¹ **These include** the development of: camera sensors (**CCDs**) and related camera equipment; **CRT**, projection, and **LCD** displays; analog and digital **HD-VCRs**; optical recording technologies; bandwidth compression equipment; and graphics software. Examples of the HDTV-related R&D and product development of various Japanese companies are shown in table 2-1.

Some types of production are being partitioned as well. For example, to minimize duplication and ensure economies of scale, **NHK** assigned the highly capital-intensive development and production of a 35-inch color picture tube for HDTV to Mitsubishi. In turn Mitsubishi agreed to provide competitors picture tubes off the same production line on an equally shared basis. They continued to share production even when the capacity proved to be insufficient for the unexpectedly large **market**.¹²

⁶Bob Whiskin, **BIS** Mackintosh, personal communication, Mar. 29, 1989.

⁷Note that “teletopias” are one set of approaches to local and regional information system development efforts. There are many other approaches. More broadly, one should speak of these many efforts under the rubric of “information society.”

⁸Parker and Vardaman, *op. cit.*, footnote 1.

⁹Eaton, *op. cit.*, footnote 1.

¹⁰TechSearch International, Inc., **MUSE Decoder Block Diagram** from Nikkei Electronics, Aug. 7, 1989, pp.126-127; and “Report Of the JTEC Evaluation Team on HDTV Developments in Japan,” National Science Foundation, July 26, 1989.

¹¹Parker and Vardaman, *op. cit.*, footnote 1.

¹²Howard Miller, **PBS**, personal communication, May 8, 1989; Oct. 12, 1989.

Table 2-I—Selected HDTV Technology Development Efforts by Japanese Companies

Firm	Cameras		Recording			Transmitter/receiver		Displays				Total corporate sales (est. 1989) (\$ billions)
	Tube	CCD	Optical	Digital	Analog	Encoder/decoder	Projection					
							CRT	CRT	SS	FPD		
Canon	-	-		R		C	C					\$ 8.9
Fujitsu	R			R	R	R	R	C	R	-	R	17.8
Hitachi	R		R	R	R			R	C	-	R	46.0
Ikegami	C	R				C		C	C	-	-	0.4
Matsushita	R	R	R		R		R	C	C	-	R	40.0
Mitsubishi	-	-		C			R	C	C	-	R	19.2
NEC	-	-	-		R	R	C	C	C	R	R	22.4
Pioneer	-	-	R				R	C	R	-	-	1.5
Sanyo	R	R	C	R	R	R	C	C	C	R	R	10.7
Sharp	R	R	R		R		R	C	C	R	R	10.0
Sony	C	R	C		R		R	C	C	-	R	15.5
Toshiba	-	R	R		R	C	C	C	C	-	R	29.2
JVC	R	R	C		R		R	C	R	-	-	5.9

NOTES: R—research; C—commercializing. Camera tubes are similar to those used today; CCDs (charge-coupled devices) are a type of solid-state sensing element. Optical recording systems are typically optical disks; digital recording systems are usually for studio use; and analog recording systems are primarily for home use, although some using 1-inch tape are for use in the studio. CRT (cathode ray tube) displays are a large high-quality version of the picture tubes used at home today. SS (solid-state) projection displays are typically either LCDs (liquid crystal displays—like those used on many laptop computers) or deformable membranes from which light is reflected. FPD (flat panel displays) are usually LCDs but plasma display panels and other types of thin displays (ch. 5) are also under development by some firms. Whether or not the technology is under research or being commercialized is a subjective judgment because the status of these technologies is changing rapidly and because these same firms are often marketing similar technologies in less demanding applications today.

SOURCE: James G. Parker and E. Jan Vardaman, "HDTV Developments in Japan," TechSearch International, Inc., Austin, TX, 1989, citing Nikkei Electronics, Oct. 3, 1988, p. 14; and Mark Eaton, personal communications, MCC, Austin, TX. Please note that many other developments, such as equipment for studio production or satellite transmission, or subcomponents of some of the above listed systems, are not included here. Development efforts by Fujitsu General are shown as part of Fujitsu Ltd. even though it is only 33 percent owned by Fujitsu Ltd.

Through this mechanism, the competitive efforts of the participating firms are being redirected from early, high-risk basic system design to secondary features such as overall product quality, ease of operation, and manufacturing cost.¹³

The development of large area LCD displays presents a particularly interesting example of the numerous linkages—'technology fusion'—that is in part guiding Japanese policy. The most ambitious LCD effort, known as the Giant Electronics Project, is planned by MITI to be a 7-year approximately \$100 million project to develop a 40-inch diagonal flat panel display by 1996.

MITI foresees a variety of technological linkages and potential spinoffs to result from this effort. Participants will have to: produce an alkali-free glass substrate with less than 0.001-inch (20-microns) variation in thickness over the entire

40-inch diagonal area; deposit a high-precision thin-film on this substrate; develop the manufacturing skills to etch circuitry into this film to a precision of roughly 0.0001-inch (3 microns) over this entire area; develop precision techniques for automatically attaching leads and assembling the display; and invent new technologies to test it. It is relatively easy to achieve such precision in the confines of today's tiny integrated circuits, but doing so across large areas poses formidable technological challenges.¹⁴

MITI expects these capabilities to be applied in such diverse products as: ultra-high-density optical recording systems; ultra-thin photocopying systems; solar cells; optical engraving; large flat-light sources; high-precision electronic components; and "chip-on-glass" electronic packaging and assembly. The "chip-on-glass" packaging and assembly technologies in particular offer the potential for significant

¹³U.S. Congress, House Committee on Energy and Commerce, Subcommittee on Telecommunications and Finance, *Report of the Public Broadcasting Service and Comments of the Association of Maximum Service Telecasters, Inc. on High-Definition Television*, Hearings March 1989, Print No. 101-E; This approach has been used quite generally in Japan, and in several of the exceptions where basic system design was done independently at different companies; there have been serious conflicts and losses as a result. One of the best known such cases was the Sony development of Betamax and the Matsushita development of VHS Video Cassette Recorders. Although many believe that the Betamax was technically superior, the marketing muscle of Matsushita successfully made VHS the industry standard.

¹⁴Ministry of International Trade and Industry, "Development of Basic Technology for Large Surface Circuit Elements," Tokyo, September 1988; English translation provided by Parker and Vardaman, op. cit., footnote 1; Gary Stix, "Manufacturing Hurdles Challenge Large-LCD Developers," *IEEE Spectrum*, September 1989.

improvements in the production **and** the performance of advanced electronic systems (ch. 5).¹⁵

Since the mid-1960s, the total investment of **NHK** in HDTV R&D and related activities has been about \$150 million. The projects funded through **MITI**, **MPT**, and the Key Technology Center, as well as investments by private **firms** greatly increases the total R&D expenditure. Including the costs of setting up production lines, private sector investment is estimated to range **from** \$700 million to as much as \$1.3 billion. Japanese Government **financial** policies have provided an enormous pool of low-cost capital that greatly aids such investments by individual firms.

The Japanese Government is supporting much more than just HDTV. They are, for example, funding both R&D and construction of networking, database, and other information **infrastructure** at levels 10 to 100 times greater than their support of HDTV. Some argue that this indicates the greater importance of these activities; others argue that the technology and manufacturing infrastructure for producing the terminals (HDTV and related technologies) for these information networks is now in-hand and that the Japanese Government has simply moved on to the next step in developing their information society.

Financial Supports

A variety of direct and indirect government financial mechanisms are supporting the development of HDTV in Japan. **NHK** performed much of the initial research on HDTV. Funding for **NHK** is from a mandatory household color TV subscription fee of Y1070 (**\$8**)¹⁷ per month from television households. In August 1989, this fee was increased to Y2000 (\$14) for homes with satellite broadcast reception.

The Key Technology Center (**KTC**) was founded by **MITI** and **MPT** in 1985. It is funded in part by dividends **from** government-owned shares of **NTT** and Japan Tobacco, Inc., and direct contributions **from** government financial institutions, and the private sector.¹⁸ **By mid-1989, the KTC had supported** some 141 company projects and 75 consortia, of which several are HDTV-related.¹⁹ Loans of up to 70 percent of the total outlay are available with no payments due on the principal or interest for up to 5 years. The principal is then repaid within 10 years of completion of the project. There is a ceiling on the interest of about 5 percent which is paid **if the** project is successful, but is waived entirely if the R&D project fails. An advisory board to the **KTC** passes judgment on the degree of success of a project and the amount of interest to be **repaid**.²⁰

A web of financial supports is also being provided for **HiVision** development and promotion efforts. In the **MITI HiVision** Communities program, special loans are available from the Japan Development Bank and the **Hokkaido Tohoku** Development Fund for **HiVision** equipment, software, or promotion. The loans will cover up to 40 percent of the costs at 5 percent interest with up to 3-year grace periods and 15-year repayment times. No-interest loans for facility construction are available with similar grace periods and repayment times.²¹

Small and medium-sized businesses are included in the **MITI** plan. Performing R&D, initiating a business, or promoting a market related to **HiVision**, or purchasing **HiVision**-related products can make one eligible to receive a 15-year loan of up to Y100 million (\$700,000) at 3.5 percent interest the first 3 years and 5.4 percent after. Even more favorable loan rates are available to small businesses in smaller towns and rural areas.²²

¹⁵MITI, "Development of Basic Technology for Large Surface circuit Elements," Op. cit., footnote 14.

¹⁶Cohen, op. cit., footnote 1; Denshi Kogyo Geppo, Mar. 1989, pp. 2-11; Kenneth Flamm, Brookings Institution, personal communications; Oct. 13 and Oct. 25, 1989.

¹⁷Based on Y140=\$1.00 and rounded off.

¹⁸Parker and Vardaman, op. cit., footnote 1.

¹⁹Mark Eaton, MCC, personal communication, Oct. 17, 1989. Note that the KTC functions much like an investment bank. It creates new companies in the form of consortia and provides up to 70 percent of the capital. If the effort of the consortia looks like it will be successful, the companies involved will then fund an increasing portion of the work until, after 5-7 years, it is a stand-alone company. Other activities of the KTC include: lending to projects within companies, mediating (especially technology transfer) between national laboratories and private companies; supporting contract research; creating and promoting databases; and handling trust funds to sponsor foreign researchers in Japanese labs.

²⁰Parker and Vardaman, op. cit., footnote 1.

²¹MITI, "HiVision Application Guide, HiVision Community Concept," July 31, 1989, p. 31; Translation provided by Eaton, op. cit., footnote 1.

²²MITI, op. cit., footnote 21.

Potentially significant tax benefits are provided in the **MITI** plan as well. For example, expenditures on **HiVision** promotion in **MITI HiVision** Communities can be taken as a loss for tax purposes.²³ Tax advantages can occur in a wide range of other settings. For example, small and medium-sized businesses that buy or lease satellite communication facilities can receive accelerated depreciation or other tax **considerations**.²⁴

The government has also directly reduced risk to **firms** by acting as a holding company—purchasing expensive equipment and then leasing it back to firms. The **MPT** is now **planning** to establish a \$740 million holding company for the BS-4 satellite due to be launched in 1997. Companies will then be able to lease HDTV channels on that satellite according to market conditions.

Using satellites for HDTV is an example of the Japanese effort to develop mutually supporting markets. Although the satellite systems for HDTV could have been purchased from the United States, the Japanese Government has instead pursued a program of developing a domestic space industry. This effort began with the February 1983 launch of Japan's first commercial communications satellite, which cost three times more than similar or better systems that **could** have been purchased from the United States.²⁵ Japanese efforts to create a domestic HDTV industry are thus channeled into supporting the domestic space industry as well.

Finally, HDTVs will not be purchased if HDTV-compatible **programming** is not available. Thus, both **MPT** and **MITI** have established leasing companies. Nippon **HiVision** was formed in April 1989 by the **MPT**, **NHK**, and 40 private companies to purchase and then lease HDTV equipment to broadcasters. **MITI** is establishing a leasing company with about 30 private companies to lease HDTV equipment and software to movie producers, electronic publishers, and non-profit groups such as

schools and museums. These leasing companies reduce risks for both manufacturers and users of HDTV equipment—by guaranteeing sales for producers, providing equipment to users at low cost, and ensuring that movies and TV programs of HDTV quality are produced for viewers to watch. Sony's recent purchase of Columbia Pictures for \$5.6 billion is seen by some as a move to ensure that there will be programming available for Sony manufactured HDTVs.²⁶

Market Promotion

R&D and financial supports can assist in getting the products to market, but will not sell them. To stimulate market demand, the **MPT** and **MITI** have established a number of promotional committees and councils. These groups are staging public events with HDTV and have begun extensive procurement efforts.

The **MPT HiVision** Promotion Council, for **example**, broadcast the Seoul Olympics to 205 **HiVision** sets at 81 public sites across Japan. Other promotional efforts organized by **NHK**, **MITI**, and **MPT** include: The World Fashion Fair held in **Osaka**, **Kobe**, and **Kyoto** during **HiVision** week (Nov. 18-26, 1989); the **HiVision** Gallery for the Gifu Museum of Art—in which nearly half of their works have been put into an electronic **file** system for viewing on a large screen; the Exposition of Flowers and Greenery in **Osaka** (April to September 1990); and many **others**.²⁷ **MITI's HiVision** Promotion Center also helps set standards for industrial HDTV equipment and surveys new uses for industrial use of HDTV.²⁸

Private **firms** and consortia are also investing heavily. Recently, Japan Victor Company (**JVC**) contracted with a Hollywood producer for \$100 million to produce **films**.²⁹ It had earlier considered purchasing a Hollywood studio but backed off for

²³Ibid.

²⁴Parker and Vardaman, op. cit., footnote 1.

²⁵Johnson, Op. Cit., footnote 1.

²⁶“Why Sony is Plugging Into Columbia,” *Business Week*, Oct. 16, 1989, p. 56. There have been other notable deals for U.S. entertainment companies recently, including Australian Qintex Entertainment, Inc. purchase of MGM/UA Communications, Inc. for \$1.5 billion. Such deals are not related to the development of HDTV nor the penetration of the potential U.S. HDTV market, however. “Invasion of the Studio Snatchers,” *Business Week*, Oct. 16, 1989, p. 52.

²⁷Parker and Vardaman, op. cit., footnote 1.

²⁸James G. Parker, TechSearch International, Inc. personal communication, Oct. 6, 1989.

²⁹Richard W. Stevenson, “Japanese Put Up \$100 Million To Back Films in Hollywood,” *New York Times*, Aug. 21, 1989.

fear of a consumer backlash to the large number of recent foreign purchases of Hollywood companies.³⁰

The parallel **MPT HiVision Cities** and **MITI HiVision Communities** programs are among the more ambitious of these market development efforts.³¹ These projects are intended to demonstrate **HiVision** hardware and software, stimulate the purchase and use of **HiVision** equipment, and provide a test market for **HiVision** applications.³² The **MPT HiVision Cities** program, for example, selected 14 cities from 71 proposals in March 1989 to receive support in purchasing and using **HiVision** equipment. These cities are pilot projects to study uses for HDTV, including developing video and graphics databases for museums, schools, and other public uses, and to use leading-edge information technologies and services to stimulate the local economy.³³

By American standards the Japanese seem to be marching in lock step, but there are inevitable tensions. The development of HDTV has created conflicts between **NHK** and private broadcasters. Similarly, the numerous parallel programs described above indicate the intensity of the competition between **MITI** and **MPT** to take the lead in HDTV—which both see as the gateway to Japan's information society of the future.³⁴ For **MITI**, this maybe a particularly important turf battle as their traditional role of "protecting and nurturing Japanese industries until they could compete in any market in the world"³⁵ is ending and they must find new roles to play.³⁶

It is too early to tell whether this competition between **MITI-MPT** will slow or speed Japanese efforts in HDTV and telecommunications. For example, **MITI** proposed its "New Media Community" and **MPT** countered with its "teletopia" program in the summer of 1983. The combined costs, however, proved too much for the Diet (the Japanese parliament), and both proposals were dropped in 1984. Not until 1986 was a compromise found that allowed them to move forward.³⁷ In other cases, competition might heighten efforts.

Given their lead in developing HDTV technology and their desire to penetrate foreign markets, the Japanese have worked intensively to ensure that their standard was adopted worldwide. This effort stalled at the May 1986 meeting of the **CCIR** in Dubrovnik, Yugoslavia, when European countries refused to accept the Japanese standard. Their refusal was based on: the lack of compatibility³⁸ of this standard with existing European systems and the cost of converting between these formats; the competitive threat they foresaw to European domestic television manufacturers posed by the Japanese; and the haste with which the single standard was being pushed on them.³⁹

EUROPE

Europeans formed a joint venture HDTV development effort in June 1986 known as "Eureka Project 95." The project is charged with development of European production, transmission, display, recording standards, and equipment. Proposals are expected to be ready for presentation to the 1990 and/or 1994 Plenary Assembly of the **CCIR** for acceptance

³⁰"Invasion of the Studio Smtchers," *Business Week*, Oct. 14, 1989, p. 54.

³¹Note that there are no reliable estimates of how much the **MITI** Communities and **MPT** Cities plans are going to cost; it all depends on how many projects apply and how much is requested by each. The **MPT** program reportedly has roughly \$100 million pending in requests; there are no figures available for **MITI**. So-called "third sector" enterprises are being created to actually run the trial cities and communities programs once they have been formed. Mark Eaton, MCC, personal communication, Oct. 18, 1989.

³²U.S. Congress, House Committee on Energy and Commerce, House Subcommittee on Telecommunications and Finance, *Consortia and the Development of High Definition Systems*, testimony presented by Barry H. Whalen, Sept. 5, 1989.

³³Parker and Vardaman, op. cit., footnote 1.

³⁴Johnson, op. cit., footnote 1.

³⁵Johnson, Op. cit., footnote 1, p. 183.

³⁶David E. Sanger, "Mighty **MITI** Loses Its Grip," *New York Times*, July 9, 1989, p. E1.

³⁷Johnson, op. Cit., footnote 1.

³⁸This lack of compatibility is believed by some to have been a strategic choice by Japanese manufacturers to force the junking of existing equipment, to increase their companies sales, and to squeeze competitors—who generally cannot afford to risk the long payback times that an incompatible system would require due to its slow acceptance. At the same time, the lack of compatibility with present TV sets was the fundamental flaw of the Japanese system which allowed it to be successfully attacked. Adam Watson Brown, "Towards the Triumph of the Matte Black Box," vol. 16, *Nol, Intermedia*, January 1988.

³⁹Joseph Roizen, "Dubrovnik Impasse Puts High-Definition TV On Hold," *IEEE Spectrum*, September 1986.

as a co-world standard. NV Philips Co. (Netherlands) is President of Eureka Project 95 and Thomson SA (France) is Vice President. Robert Bosch GmbH (Federal Republic of Germany), Them/EMI (United Kingdom), and more than 20 other organizations from 9 countries are participating in the effort as well. Approximately 1,700 engineers, technicians, and support personnel have been involved full time in the project.⁴⁰

The first phase of the Eureka Project 95 ended in December 1989 and cost an estimated \$318 million.⁴¹ Sixty percent of these funds were private.

Europeans plan to begin public broadcasts of digital sound and provide a slightly improved picture to viewers through their MAC (Multiplexed Analog Components) system in 1990. Broadcasts using the Extended Definition wide-screen ED-MAC system are scheduled for late 1991, and full HDTV-MAC broadcasts are planned for 1994.⁴² By 1995, European broadcasters plan to offer full HDTV satellite and cable services.⁴³ Like the Japanese, the major focus of European HDTV efforts has been Direct Broadcast Satellite systems.⁴⁴

HDTV promotional efforts currently scheduled include broadcasts of the 1990 World Cup Soccer Championships from Italy; and broadcasts of the 1992 Summer Olympics from Barcelona, Spain. One thousand public receivers will be scattered throughout Europe to receive these broadcasts.⁴⁵ As in Japan, there have also been efforts in Europe to

extend the performance of existing TV systems rather than proceeding to new and completely incompatible systems. There is some concern that such a move could slow the market acceptance of their MAC system.⁴⁶

Market Protection

The Europeans formed the Eureka Project 95 in part to support their domestic consumer electronics industries. In addition to stimulating R&D to ensure competitiveness, the Europeans have aggressively enforced antidumping statutes and have imposed domestic content requirements in those sectors where dumping has occurred. In electronics, for example, there are now domestic content requirements for both systems and components. Regulations require the skill-intensive integrated circuit fabrication steps, for example, to be done in Europe. Minimum prices have been set on DRAMs, as in the United States.⁴⁷ Regulations have also been implemented that prevent products from simply being transshipped through other countries (including the United States) with minimal additional manufacturing.⁴⁸

Similarly, Europe is concerned with protecting its domestic movie and TV-program producers as well as its cultural identity. As Direct Broadcast Satellites (with conventional TV broadcasts) begin operations over new channels in Europe they are filling air time with U.S. TV programs and movies.⁴⁹ Faced by a deluge of U.S. programs, the European Community

⁴⁰Eureka Secretariat, project documents.

⁴¹Peter De Selding, "Europeans Feeling Cocky When It Comes to HDTV," *New Technology Week*, Sept. 11, 1989; Eureka Secretariat, project information. The budget for 1988-90 is 270 million ECU.

⁴²Note that the European system is compatible with existing standards only by using electronic converters in their satellite receiving equipment to change the MAC transmissions to PAL or SECAM. William Schreiber, Massachusetts Institute of Technology, personal communication Oct. 12, 1989.

⁴³Wesley R. Iverson, "U.S. Gropes for Unity on HDTV," *Electronics*, March 1989; Bob Whiskin, BIS Mackintosh, personal communication, Mar. 28, 1989; Hugh Carter Donahue, "Choosing the TV of the Future," *Technology Review*, April 1989.

⁴⁴Paul Gregg, "Satellite TV Flies European Flag," *Electronics Weekly*, Sept. 27, 1989.

⁴⁵Roger Woolnough, "World-Class HDTV," *Electronic Engineering Times*, Sept. 11, 1989, p. 18.

⁴⁶"German EDTV Tests," *TV Digest*, vol. 29, No. 32, Aug. 7, 1989, p. 15.

⁴⁷Andrew Pollack, "Europe Sets Prices for Japan's chips," *New York Times*, Jan. 24, 1990. Note that EC regulations have recently been successfully challenged under GATT See, William Dullforce, "Japan Scores Victory Over EC on Duties," *Financial Times*, London, Mar. 29, 1990; and Peter Montagnon and Lucy Kellaway, "EC Refuses To Adopt GATT Report on Dumping," *Financial Times*, London, Apr. 4, 1990.

⁴⁸The new EEC rules require that the most substantial process in producing a semiconductor be done in Europe. *European Market Digest*, vol. II, No. 6, June 1989, p. 9.

⁴⁹Jacques Neher, "A Revolution Brews In European Television@," *Washington Post*, Mar. 5, 1989.

recently set guidelines to devote the majority of air time “where practical” to European programs.⁵⁰

Eureka

The Eureka Project 95 to develop HDTV is part of the much larger Eureka program begun in July 1985 by 19 European nations to support collaborative multinational efforts in high-technology R&D, manufacturing, and services. Eureka was founded on the recognition that many of the European national markets are too small for a “national champion” firm to achieve a level of sales capable of recovering development and manufacturing costs for many high-technology items. For example, the R&D costs for a new generation of public phone switching equipment have been estimated at \$700 million to \$1 billion and it would require sales of \$14 billion to recoup these costs.⁵¹ As a consequence, numerous European collaborative R&D efforts have been launched in recent years, including the \$1.5 billion RACE project in telecommunications, the \$5 billion JESSI project in semiconductors, and several others.⁵²

Procedures for establishing a project under Eureka are both fast and flexible. Industry groups define and propose their project to their respective national governments. If they do not already have partners to work with, the Eureka Secretariat tries to identify such groups. With the agreement of the respective national governments, the proposal begins a 45-day period of circulation and discussion. At the end of this period a gentleman’s agreement or, sometimes, an early formal agreement is reached on whether or not to move the project forward.

European nations are also moving rapidly to upgrade their communications systems through the implementation of ISDN (Integrated Services Digital Network). ISDN allows voice, video, and data to be carried over telephone networks in a digital

format (ch. 3) and is the next important step in telecommunications systems. European efforts in HDTV and telecommunications promise to make them important competitors in these markets.

UNITED STATES

After black and white TV was introduced in the 1940s and color TV in the 1950s, American researchers looked for ways to further improve resolution, color, and picture quality during the late 1950s and 1960s. They achieved resolutions in experimental systems roughly comparable to those now being demonstrated by the Japanese.⁵³ These advanced capabilities, however, were not pursued: the costs of these systems would have been far too high for consumer use; the newness of the medium had not yet whetted consumers’ appetites for dramatic improvements in picture resolution; and practical transmission technologies (e.g., bandwidth compression) were not available. By the late 1970s when electronics technologies had matured sufficiently to make consumer HDTV systems a reasonable goal, U.S. firms were rapidly ceding TV manufacturing to foreign firms (see table 1-2). These factors limited further development of HDTV in the United States until recently.

RCA’s Sarnoff labs began research in HDTV in the late 1970s. By mid-1987, some \$40 million had been spent overall on its advanced television work, with an estimated \$35 million required to finish development of the system they are proposing to the FCC.⁵⁴ CBS has also worked on HDTV. In 1981, CBS requested permission from the FCC for use of the 12 GHz spectrum and began terrestrial broadcast experiments in 1982.⁵⁵ Some foreign firms have been active in HDTV research in the United States as well, including Philips (Netherlands) and, with its recent purchase of RCA, Thomson (France).

⁵⁰Steve Lohr, “European TVs Vast Growth: Cultural Effect Stirs Concern,” *New York Times*, Mar. 16, 1989, p. A1; U.S. Congress, House Committee on Energy and Commerce, Subcommittee on Telecommunications and Finance, *Television Broadcasting and the European Community*, Hearings July 26, 1989, Serial No. 101-84; Edward Cody, “EC Adopts European TV Program Quota,” *Washington Post*, Oct. 4, 1989, p. F1; Paul Farhi, “U.S. to Fight EC Directive Limiting Foreign TV Shows,” *Washington Post*, Oct. 11, 1989, p. F1.

⁵¹Godefroy Dang Nguyen, “European R&D Policy for Telecommunications” *Kurzfassung einer Studie im Auftrag des WIK, Bad Honnef*, April 1989, Nr. 49.

⁵²Steven Greenhouse, “Europeans United To Compete With Japan and U.S.,” *New York Times*, Aug. 21, 1989.

⁵³William Glenn, Florida Atlantic University, Boca Raton, Feb. 10, 1989; Schreiber, *op. cit.*, footnote 42.

⁵⁴U.S. Congress, House Committee on Energy and Commerce, Subcommittee on Telecommunications and Finance, *Testimony of Steven Bonica*, Serial No. 100-188, Oct. 8, 1987.

⁵⁵Corey P. Carbonara, “History of High Definition,” paper presented at the “HDTV: The Second Annual conference and Exhibition on High Definition Television,” Arlington, VA, Feb. 12, 1990.

Other HDTV efforts that began in the late 1970s and early 1980s include those by: Zenith; William Glenn, New York Institute of **Technology**⁵⁶; William Schreiber, Massachusetts Institute of Technology; Yves **Faroudja** of **Faroudja** Laboratories; Richard **Iredale**, **Del Rey** Group; and others. The small size of most of these efforts, however, has limited the extent and rate of progress in HDTV and related technologies in the United States. Total private expenditures on HDTV R&D in the United States were roughly \$70 **million**⁵⁷ as of early 1988.

There has been little public-private cooperation in the U.S. HDTV effort compared to Japan and Europe. Significant amounts of money have been spent, however, on related technologies such as digital signal processing for military radar and sonar **applications**.⁵⁸

Production Standards

HDTV requires new standards for producing video material. These standards might include such factors as the number of lines (resolution), the frame rate (50 in Europe v. 59.94 in the United States), and the type of scaming (interlaced or progressive). If these production standards differ **from** one region to another, expensive **transcoding** might be required for programs produced in the United States to be shown in Europe and vice versa. This could dampen international trade in movies and TV programs.

Many U.S. movie and TV-program producers have promoted a single international production standard to avoid this possibility. A single worldwide production standard would aid the exchange of video material between countries and help U.S. program producers maintain their current \$2.5 billion annual export **market**.⁵⁹ Everyone is interested in improving international communication and understanding: uniform world standards might help achieve this ideal.

The Society of Motion Picture and TV Engineers (SMITE) formed a Working Group on High **Definition** Electronic Production in 1977 and began work in 1981 on a production standard. One concern of this group was to document and standardize HDTV-production equipment development. A second concern of the **SMPTE** was that differing European, American, and Asian production standards would limit the U.S. producers **global** marketing of their programs.

The work done by the **SMPTE** resulted in a set of parameters which differed slightly **from** the **NHK** 1125/60 system, then the only system available in the world and one of the focuses of the **SMPTE** work. These parameters were adopted by the **Japanese**.⁶⁰ The U.S. Advanced Television Systems **Committee**⁶¹ (**ATSC**) recommended the resulting 1125/60 standard to the U.S. State Department and it was supported by the official U.S. delegation at the Dubrovnik meeting of the **CCIR** in May 1986. A chronology of all these various activities within the United States is listed in table 2-2 and many of the groups actively involved with Advanced TV development in the United States are listed in table 2-3.

A number of domestic groups, however, opposed the 1125/60 standard developed by the **SMPTE** and others. NBC and ABC, for example, have opposed approval of the 1125/60 format because they expect that conversion from 1125/60 to whatever standard is chosen for the United States, such as 1050/59.94, will be costly and will introduce unacceptable flaws in the picture—thus hurting their domestic broadcasting **market**.⁶² Instead, they believe that a transmission standard should be chosen first that meets U.S. needs. Following that, a family of international production **standards** can be established to best fit the national needs of each country. American broadcasters are also concerned with the potential costs of converting their equipment to HDTV and

fire. Glenn is currently with Florida Atlantic University, Boca Raton.

⁵⁷Larry F. Darby, "Economic Potential of Advanced Television Products," National Telecommunications and Information Administration, Apr. 7, 1988.

⁵⁸For research directly related to HDTV, relatively little has been spent, with NASA a particularly important supporter of HDTV-like R&D.

⁵⁹This is the net U.S. trade for 1988 in motion pictures and TV programs. Motion Picture Association of America/Motion Picture Export Association of America, "Fact Sheet: Film and Video Piracy."

⁶⁰The **SMPTE** began their work assuming no parameters and spent several years looking at a variety of factors such as achromaticity before setting line and frame rates. Birney Dayton, NVision, personal communication, Oct. 12, 1989.

⁶¹An ad hoc group formed in 1984 by various groups (see Box 3.3) to develop voluntary standards for HDTV.

⁶²C\$HDTV Production: The Future Is Almost Now," *Broadcasting*, Oct. 17, 1988, p.39.

Table 2-2-Chronology of N development

1928	Radio Manufacturers Association begins planning for B&W TV	1984	FCC allows the introduction of stereo sound broadcasts
1936	RCA demonstrates prototype B&W TV	1985	ATSC recommends the NHK production standard to Department of State
1939	First public TV broadcast done at New York World's Fair	1986	National Association of Broadcasters forms task Force on HDTV
1941	NTSC standards are set for B&W TV	1986	U.S. Department of State and Japanese propose NHK production standard to CCIR
1953	NTSC standards are set for color TV that is compatible with B&W sets	1986	Europeans begin Eureka project to develop their own HDTV system
1960s	U.S. firms develop prototype high-resolution TV systems	1987	National Cable Television Association forms Committee on HDTV
1964	All-Channel Receiver Law enacted	1987	FCC creates Advisory Committee on Advanced Television Services (ACATS)
1964	Japanese state-owned broadcasting system NHK begins HDTV development	1988	Electronic Industries Association forms an Advanced TV Committee
1972	NHK submits draft HDTV study program to CCIR	1988	American Electronics Association forms a task force on HDTV
1977	Society of Motion Picture and TV Engineers (SMPTE) begins study of HDTV	1988	Advanced Television Test Center established
1979	NHK conducts first satellite transmission tests of HDTV	1988	Bell South/Bellcore transmits HDTV by fiber at Democratic National Convention
1981	First demonstration of HDTV in US; SMPTE recommends action on HDTV in US	1988	FCC tentatively decides HDTV must be compatible/simulcast with NTSC; no additional spectrum will be made available outside existing bands
1982	CBS conducts transmission tests in satellite broadcasting frequencies	1989	DARPA announces \$30 million of funding for HDTV R&D
1982	CBS announces two-channel HDTV system		
1983	The Center for Advanced Television Studies (CATS) is formed		
1984	The Advanced Television Systems Committee (ATSC) is formed		
1984	Japanese NHK establishes the MUSE transmission standard for DBS		

SOURCE: Adapted from: "A Chronology of High-Definition Television Development," *Variety*, Oct. 12, 1988, pp. 74-75; Tonv Uyttendaele, ABC, personal communication, Sept. 7, 1988; and Electronic Industries Association, "Chronology of TV and" AT/Development," Nov. 30, 1988, Washington, DC.

are considering intermediate EDTV quality systems as a substitute.

Official U.S. support for the Japanese/ATSC 1125/60 standard was reversed in May 1989 due to the unsuitability of its use within the United States; the recognition that 1125/60 would not be adopted as a world standard due to European opposition; and political opposition to handing the Japanese a competitive advantage in manufacturing HDTVS.⁶³

Program production standards that can easily be **transcoded** from one system to the other (which the original Japanese NHK system cannot) are, however, still possible and **desirable**.⁶⁴ Work on such a "Common Image Format" was proposed by the U.S. delegation and endorsed for further study at the May 1989 CCIR Extraordinary Meeting for HDTV.

Transmission Standards

The FCC formed the Advisory Committee on Advanced Television Service in 1987. The Advisory

committee formed three **Subcommittees**—Planning, Systems, and Implementation—to review proposed terrestrial broadcasting standards for the United States.

In September 1988, the FCC issued a tentative decision that whatever new transmission standard was chosen, HDTV broadcasts should also be available to those with today's NTSC sets. Further, additional spectrum outside of today's UHF and VHF bands for TV broadcasting would not be made available for HDTV, although individual stations might get as much as 6 MHz additional spectrum within these bands.

New Initiatives

U.S. Government efforts in support of HDTV R&D have increased during 1989. In December 1988, Defense Advanced Research Projects Agency announced a \$30 million, 3-year R&D program for high-resolution displays and supporting electronics.

⁶³John Burgess, "U.S. Withdraws Support for Studio HDTV Standard," *Washington Post*, May 6, 1989; Lucy Reilly, "State Department Changes Stance On HDTV Standards," *New Technology Week*, May 1, 1989.

⁶⁴w. F. Schreiber, "A Friendly Family of Transmission Standards For All Media and All Frame Rates," Draft, Feb. 12, 1989, Massachusetts Institute of Technology, Cambridge, MA.

Table 2-3-Private U.S. Groups Involved With HDTV^a

Group	Purpose	Members
Ad Hoc Group on ATV	To recommend policy to aid U.S. HDTV efforts	Various; organized by researchers at MIT
Advanced TV Research Program (ATRP)	R&D for advanced TV systems and Associated Regulatory Policies	ABC; NBC; HBO; PBS; Ampex Tektronix; RCA; Zenith; Kodak; General Instruments; etc.
Advanced TV Systems Committee (ATSC)	Develop voluntary standards for HDTV	Electronic Industries Association; IEEE; National Association of Broadcasters; National Cable TV Association; Society of Motion Picture and TV Engineers; etc.
Advanced TV Test Center (ATTC)	Testing of ATV systems	National Association of Broadcasters; Association of Maximum Service Telecasters; Association of Independent TV Stations; Capital Cities/ABC; CBS; NBC; PBS; etc.
American Electronics Association (AEA)	To assist U.S. firms in electronics manufacturing	U.S. hi-tech electronics firms including: AT&T; IBM; Hewlett-Packard; Motorola; Intel; ITT DEC; National Semiconductor; Tektronix; TI; Zenith; etc.
American National Standards Institute (ANSI)	A national standard setting organization that sets voluntary standards for the U.S. and helps develop U.S. position internationally	Various
Association of Maximum Service Telecasters (MST)	To find means for 100al stations to provide HD service	270 local stations: independent or network affiliate
Broadcast Technology Center Cable TV Labs. Inc.	R&D for broadcasters into HDTV R&D in HDTV for the cable TV industry	National Association of Broadcasters; CBS; etc. 63 cable TV companies with over 75% of U.S. cable subscribers
Center for Advanced TV Studies (CATS)	Funding for independent TV R&D	ABC; Ampex; CBS; Kodak; Zenith; NBC; PBS; RCA; HBO; 3M Co.; Harris Corp.
Electronic Industries Association (EIA)	To recommend policies on Advanced TV	Foreign and U.S. firms: Foreign consumer electronics firms include: Mitsubishi, NEC, Sony, Philips, Panasonic, Thomson, Hitachi, etc.
HDTV 1125/60 Group	To promote the 1125/60 (modified version of original NHK) production standard	Sony; NEC; Panasonic; JVC; Toshiba; Chyron; Cinema Products; Compression Labs; Dynair Electronics; etc.
Institute of Electrical and Electronics Engineers (IEEE) Technology Activities Council	To recommend policy to promote U.S. interests in electronics	Represents 240,000 engineers in the U.S.
Motion Picture Association of America (MPAA)	Trade Association for U.S. motion picture industry	Various
National Cable TV Association (NCTA)	To assess HDTV systems for cable applications	Telecable; Scientific Atlanta; General Instrument; HBO; ESPN United Artists Cable; Fox Cable; Warner Cable; etc.
National Association of Broadcasters	Trade Association for U.S. radio and TV broadcasters	Various
Society of Motion Picture and TV Engineers (SMPTE)	Technical society developing voluntary recommended standards and practices	Various end users, manufacturers, and individual engineers from the TV and film industry
Telecommunications Industry Association (TIA)	To present position of telecommunications supply companies on HDTV	Alcatel, NA; AT&T; Corning Glass; GTE; Hughes; IBM; Motorola; Scientific-Atlanta

^aThis list is not inclusive.

SOURCE: Electronic Industries Association, "Non-Governmental Groups Involved With HDTV," HDTV Information Packet, Washington, DC, Nov. 30, 1988; Greg Depriest, Association of Maximum Service Telecasters, personal communication, Jan. 18, 1990.

DARPA received 87 proposals requesting roughly \$200 million. By November 1989, 11 contractors had been named.⁶⁵ Congress appropriated \$20 million for this R&D in the fiscal 1990 budget, but stipulated that the money could not be spent until the Administration had developed a comprehensive program for HDTV.

U.S. commercial interests have also attempted to forge a basis for public-private cooperation. In May 1989, the American Electronics Association (AEA) Advanced Television Task Force, representing 36 U.S.-owned firms, proposed a \$1.35 billion (government share) 6-year program of R&D, low-cost loans, and loan guarantees to assist U.S. manufacturers in

⁶⁵Brian Robinson, "DARPA Names HDTV Contractors," *Electronic Engineering Times*, June 19, 1989, p. 11; Richard Doherty, "Six Firms Get DARPA HDTV Nod," *Electronic Engineering Times*, Oct. 30, 1989, p. 1.

designing, developing, and producing HDTVs. This effort, however, met considerable skepticism. A report **from** the Congressional Budget **Office (CBO)** in July 1989 questioned the premise that HDTV was an important market that U.S. **firms** should **enter**.⁶⁷

Lacking support at home, the tentative unity of U.S. industry groups began to **fray**. In November 1989, an initial agreement was reached between the U.S. Semiconductor Industry Association and the Electronic Industry Association of Japan for U.S. **firms** to supply Japanese HDTV manufacturers with **chips**.⁶⁸ Some observers cited this action as a good faith effort on the part of Japan to increase use of American chips.

Skeptics, however, noted that U.S. producers received no guarantees as to what proportion of the

semiconductors in **Japanese** HDTVs would be **sourced** from them. The general failure of the Semiconductor Trade Agreement to substantially increase U.S. chip sales in the Japanese market was offered as a basis for questioning the value of this HDTV accord. Skeptics suggested that the Japanese might use this agreement to influence the debate in the United States over which broadcast standards are chosen. If Japanese HDTVs contain a **significant fraction** of U. S.-**sourced** semiconductors, it would be much more **difficult** to restrict imports in favor of U.S.-developed or U.S.-produced HDTVs. In that case, it might also be more **difficult** to just@ supporting the development of a domestic HDTV industry.

⁶⁶American Electronics Association, "Development of a U.S.-Based ATV Industry," May 9, 1989.

⁶⁷Congressional Budget Office, "The Scope of the High-Definition Television Market and Its Implications for Competitiveness," Staff Working Paper, July 1989.

⁶⁸David Sanger, "Industries in U.S. and Japan Form Alliances on New TV Technology," *New York Times*, Nov. 9, 1989, p. A1.

Communications Technologies

INTRODUCTION

The U.S. electronic communication infrastructure is a mixture of five media: 1) terrestrial **radiofrequency** transmissions; 2) satellite **radiofrequency** transmissions; 3) paired copper wires; 4) coaxial cables; and 5) optical **fibers**.¹ Each plays a role in providing efficient communication services for the United States (table 3-1). Rapid technological and economic changes are reshaping the roles these media play in our communication system.

Terrestrial broadcasting and coaxial cables distribute the major share of television to consumers today. Satellite transmission has filled the need of

those not served by cable TV (CATV) or who are too far from broadcast stations to receive a reliable signal. HDTV could change the competitive balance between these various media and may stimulate the delivery of television services by other means, including direct broadcast satellite and, in the long-term, switched optical fibers through the telephone system. HDTV may also allow significant improvements in the efficiency of spectrum use. This might enable services now constrained by a lack of spectrum to be expanded.

The shift towards a digital operating environment is making the media perform more alike. Digitization can provide a common format that allows

Table 3-1—The U.S. Communications Infrastructure

Technology	Businesses	Year began	Current capacity	Approximate number of nodes	Available audience	Service industry revenues		
Copper pairs	Telephone, data communication (LANs, WANs, MANs)	1876	From 3 kHz for single analog voice channel 144 kbps for basic ISDN	23,000 exchanges 240,000 PBXS	93% w/phones 20% w/PCs 8% w/modems	\$140 billion		
Coaxial cable	Cable TV	1948	Up to 550 MHz or 80 video channels	11,000 headends	81% of homes passed; 56% subscribe	\$14 billion		
Optical fiber	Voice, data, and video communication	1978	1.76 Gbps common and higher rates rapidly becoming available	Overlaps with copper pair and coaxial cable systems				
Terrestrial communication	AM radio	1920s	Total* spectrum; 1070 kHz;	Spectrum Channels /channel; /market 10 kHz; 27	5,000 AM stations	98% population	\$2 billion	
	FM radio	1920s	20 MHz;	200 kHz; 50	5,600 FM stations	98% population	\$4.5 billion	
	VHF TV	1946	72 MHz;	6 MHz; 7	700 [+300 LPTV] stns	98% population	\$24 billion	
	UHFTV	1952	330 MHz;	6 MHz; 10	Same	Same		
	ITFS & OFS TV	1963	138 MHz;	6 MHz; N/A	800 stations	N/A		
	MMDS TV	1962/83	60 MHz;	6 MHz; N/A	24 stations	0.1% population		
Satellite communication	Cellular telephone	1983	50 MHz;	30 kHz; varies	700 systems	1% population	\$3 billion	
	Voice, data, video	1962			530 cv. transponders			
	L band	Radio RDSS paging	1989	16 MHz;	1 sat/7 slots			
	C band	Broadcast/cable	1976	1 GHz;	40 MHz;	19** sats/35 slots	1% direct	
	Ku band	Medium-power DBS	1983	1 GHz;	40 MHz;	14 sats/35 slots		
Ku Band	High-power DBS	1987	1 GHz;	15 MHz;	0 sats/8 slots			

* Note that the total spectrum available and the spectrum per channel are set by regulation. The channels usable per market are also set by regulation in order to control interference between stations in the same geographic location.

** Four satellites serve both C-band and medium-power DBS Ku-band; slots are orbital slots where satellites might be placed, with varying numbers of transponders per satellite.

SOURCE: Adapted from U.S. Department of Commerce, National Telecommunications and Information Administration, *Telecom 2000*, NTIA Special Publication 88-21, October 1988.

¹U.S. Congress, Office of Technology Assessment, *Critical Connections: Communication for the Future, OTA-CIT-407* (Washington, DC; U.S. Government Printing Office, January 1990). More detail of the technologies and analyses of communication issues maybe found in this report.

signals to be easily moved among media—terrestrial broadcast, microwave, satellite, cable, optical fiber—without distortion.

TERRESTRIAL RADIO COMMUNICATIONS

Terrestrial radio frequency communication includes mass media such as AM and FM radio and television; mobile radio links such as cellular telephone and police radio; and special **services**—amateur radio and aeronautical and marine navigation. Ground-based microwave links are also used for long-distance telephone, data and video transmissions. (Fundamentals of communication technologies are listed in box 3-1.)

Each service using the radio frequency spectrum is assigned a range of frequencies that matches the technical needs of the user and reduces interference from others sharing the spectrum (figure 3-4).²

The **frequencies** from about 30 MHz to 1 GHz are well suited for terrestrial, short-distance communication. As the frequencies increase above 30 MHz, radio transmissions become limited to direct **line-of-sight** (reflections from the ionosphere decrease), with less interference between stations. Below 1 GHz, the strength of radio waves are not **significantly** reduced by rainfall or other atmospheric effects. Above 10 GHz, attenuation from rainfall and other atmospheric factors increases rapidly and limit the use of these higher frequencies to short-haul links or for satellite communications where the signal must pass through only a few miles of atmosphere to the receiver.³

Competition for spectrum space is often keen. As technology develops new and better communications systems, user demand can cause crowding and overuse of some bands. Cellular telephone and other mobile services are assigned frequencies adjacent to the UHF TV bands. These services have experienced phenomenal growth in several urban areas, where they now suffer **from** congestion.

The Federal Communications Commission was considering the reallocation of the upper parts of the underutilized UHF TV spectrum to these other services when the potential needs of broadcasters for

additional frequencies to broadcast HDTV led the regulatory agency to stay its **action**.⁴

Microwave systems are important links in the national telephone network and are also used in private nets. Modern digital microwave systems can achieve data rates of hundreds of megabits per second. Microwave provides line-of-sight communication, and repeaters are spaced at different intervals (commonly 20 to 30 miles) depending on terrain, weather conditions, obstructions, and frequencies.

Microwave systems operating in the 2-, 6-, and 11-GHz bands are typically used for long-distance transmission, while 18- and 23-GHz systems are better suited to short hauls due to the greater attenuation by rain at higher frequencies.

Sufficient bandwidth is available in the microwave bands to carry high-resolution, fill-motion television. Microwave-based **multichannel multipoint** distribution systems (**MMDS**) have been licensed to deliver video services in some metropolitan areas. **In** general, these ventures have had difficulty competing with conventional CATV service.

Cellular telephone is perhaps the best example of the tremendous changes taking place in the use of the radio spectrum as a result of technological advances. Conventional radio telephone service—the predecessor of cellular—has a capacity of about 25 channels, each able to carry one call. Radio telephone required a high-power transmitter and a receiver capable of communication up to 50 miles.

Cellular telephone technology dramatically increased the capacity for mobile telephone communication by breaking the service area into many “cells,” each served by its own transmitter and receiver coupled to a computer-controlled system (figure 3-5). Each cell operates at low power and short range. Neighboring cells use different frequencies to avoid interference, but cells far enough apart to avoid interference may share the same frequency. If a customer moves into the range of another cell during a call, **the frequency** is automatically switched to that cell without the caller knowing. These techniques greatly increase the carrying capacity of the limited spectrum available for

²For details of these services, see FCC Rules, 47 CFR 90 to 100.

³Where the satellite is near the horizon, the distance through the lower atmosphere could be much longer, perhaps 50 miles or more.

⁴Further Sharing of the UHF Land Mobile Radio Service, Order, 2 FCC 6441 (1987).

Box 3-1—Fundamentals

Information can be electronically communicated in an analog or digital format. Other characteristics that must be considered include: how frequently the signal must be amplified to make up for losses in the medium; how to carry several independent signals in a medium without interference; and how much information can be carried.

Analog—The analog format sends a continuously varying electronic signal proportional to the information. For example, a microphone generates a signal with a voltage **proportional** to the loudness of the speaker's voice. For applications such as radio and TV broadcasting, this signal modulates a carrier wave, most commonly by varying the amplitude (AM) or frequency (FM), figure 3-1.

Digital—For digital communications, the continuously varying signals of the real world—sound, light, etc.—are first converted to numbers (usually in a binary format, that is, as a string of “0s” and “1s”¹ proportional to their loudness or brightness. (See box 4-2.) These binary digits, orbits, can then be sent as a series of “on” or “off pulses (figure 3-2) or can be modulated onto a carrier wave. Typical modulation techniques vary the frequency, amplitude, and/or phase of the carrier wave according to whether the signal is “1” or “0.” Examples of these techniques are shown in figure 3-3.²

Amplifiers (Analog Repeaters)—Transmitted over long distances, signals are inevitably attenuated. To boost their strength, analog signals are electronically amplified by repeaters at points along the way. With each amplification, there is a tiny amount of distortion because the electronics are not perfect. In turn, because the analog signal is continuously varying, it is extremely difficult to detect or correct the distortions that creep in.

Digital or Regenerative Repeaters—digital signals are also attenuated over long distances, but digital signals are either “1” or “0.” Therefore, instead of simply amplifying the digital signal along the way and introducing more distortion each time, the data in the signal—“1s” or “0s”—are recovered and a new digital signal is generated. As long as the signal is not so severely attenuated or distorted that a “1” appears like a “0” or vice versa, there is no degradation of the data. Of course, digital signals can also be transmitted over analog systems and their signal simply amplified. Digital repeaters are also known as “regenerative repeaters.”

¹Thus, to count from 0 to 15 in binary gives the following series: 0000; 0001; 0010; 0011; 0100; 0101; 0110; 0111; 1000; 1001; 1010; 1011; 1100; 1101; 1110; 1111. Each position from the right corresponds to a power of 2 just as in the decimal system we commonly use, each position from the right corresponds to a power of 10.

²L. Brett Glass, “Modern Modem Methods,” *Byte*, June 1989; William Stallings, *Data and Computer Communications* (New York, NY: MacMillan Publishing, 1985).

Figure 3-1—Amplitude and Frequency Modulation of a Carrier

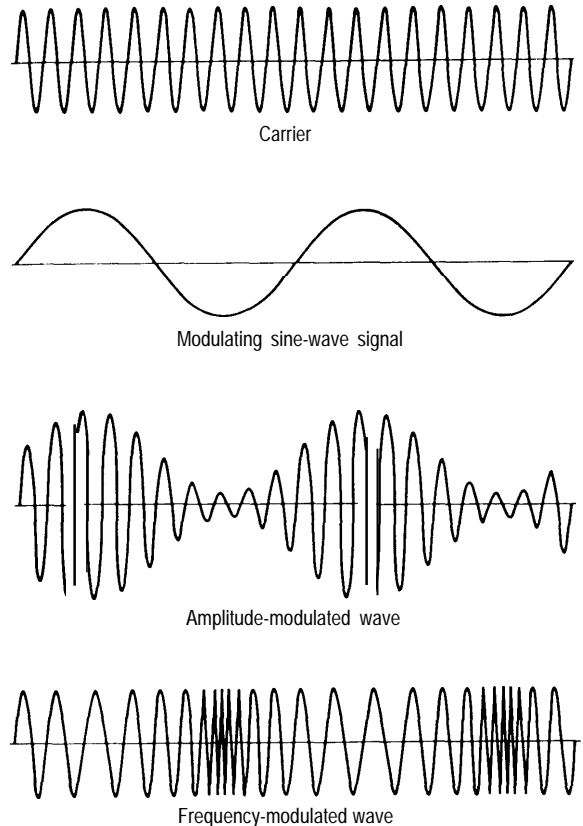

SOURCE: William Stallings, *Data and Computer Communications* (New York, NY: MacMillan Publishing Co., 1985). Used with permission.

Figure 3-2—A Digital Signal With Its Corresponding Numerical Equivalent

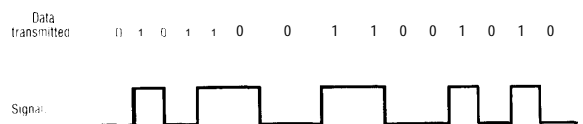

SOURCE: William Stallings, *Data and Computer Communications* (New York, NY: MacMillan Publishing Co., 1985). Used with permission.

Continued on next page

Box 3-1—Fundamentals—Continued

Repeater Spacing—High frequencies are attenuated more rapidly than lower frequencies—whether over copper pair, coaxial cable, optical fiber, or terrestrial or satellite broadcasting through the **atmosphere**—and this limits the range of carrier frequencies that can be used or else requires analog or digital repeaters to be spaced more closely.

Multiplexing—To carry more than one stream of information in a medium at a time, signals are multiplexed. Frequency division multiplexing (**FDM**) uses carrier waves of different frequencies so that a number of signals can share the same medium without interfering with one another. **FDM** is used in radio and TV broadcasting, and the frequency of the carrier wave corresponds to the channel. Time division multiplexing breaks the data into **smaller packets** and intersperses them. (See box 4-2.)

Bandwidth—Modulating a signal onto a carrier wave—whether by AM or FM—causes the frequency of the signal to vary from that of the carrier and creates “sidebands” with the signal occupying a range of frequencies about the carrier frequency. This can be most easily seen in figure 4-3 for **frequency modulation**. To prevent interference between radio or TV stations, the range of frequencies of a signal are not allowed to overlap. This range is known as the bandwidth, and is about 3 **kHz**³ for a telephone conversation; 10 **kHz** for an AM radio station; 200 **kHz** for an FM radio station; and 6 **MHz** for a TV station.⁴

The maximum potential information content or carrying capacity of an analog signal is given by its bandwidth (but is limited by the noise present). The higher information content of **HDTV** requires either wider bandwidths than today’s allotted 6 **MHz** or much more efficient use of that available.

Data Rates—The information content of a digital signal, or data rate, is measured by the number of bits per second (bps) that are transmitted. When digital signals modulate a **carrier**⁵, the data rate is determined by how efficient the encoding process is and the available bandwidth of the carrier. **Today**, data rates of as high as 7.5 bps per Hz of bandwidth are achievable with electronic signals, although at these very high rates transmission errors are more **likely**.⁶ Due to technical limitations in the semiconductor lasers that drive light through optical fibers and the sensors that detect this light, encoding efficiencies (bps/Hz) for optical transmissions are not as great as for electronic signals. Optical fibers are nevertheless able to carry much more information than twisted pairs or coaxial cables because of the greater range of frequencies they can carry without excessive attenuation.

Figure 3-3—Techniques for Modulating an Analog Carrier in Order To Send Data in a Digital Format

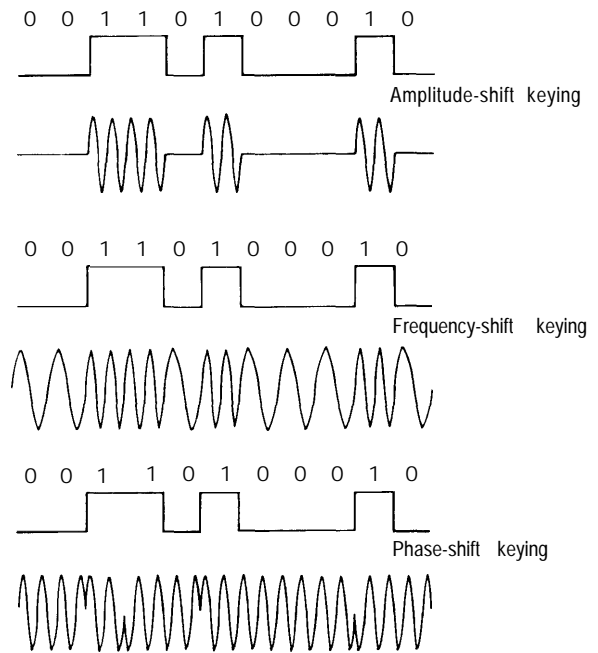

SOURCE: William Stallings, *Data and Computer Communications* (New York, NY: MacMillan Publishing Co., 1985). Used with permission.

³One **kHz** is 1,000 cycles per second; 1 **MHz** is 1 million cycles per second; 1 **GHz** is 1 billion cycles per second.

⁴For AM and FM these include guardbands; for TV, adjacent channels cannot be assigned in the same geographic region and are known as taboo channels.

⁵Note that all carriers are analog.

⁶Dale Hatfield, “Report on the Potential for Extreme Bandwidth Compression of Digitalized HDTV Signals,” Hearings before the Committee on Science, Space, and Technology, U.S. House of Representatives, Mar. 22, 1989.

Figure 3-4-Selected Allocations of the Radio Frequency Spectrum

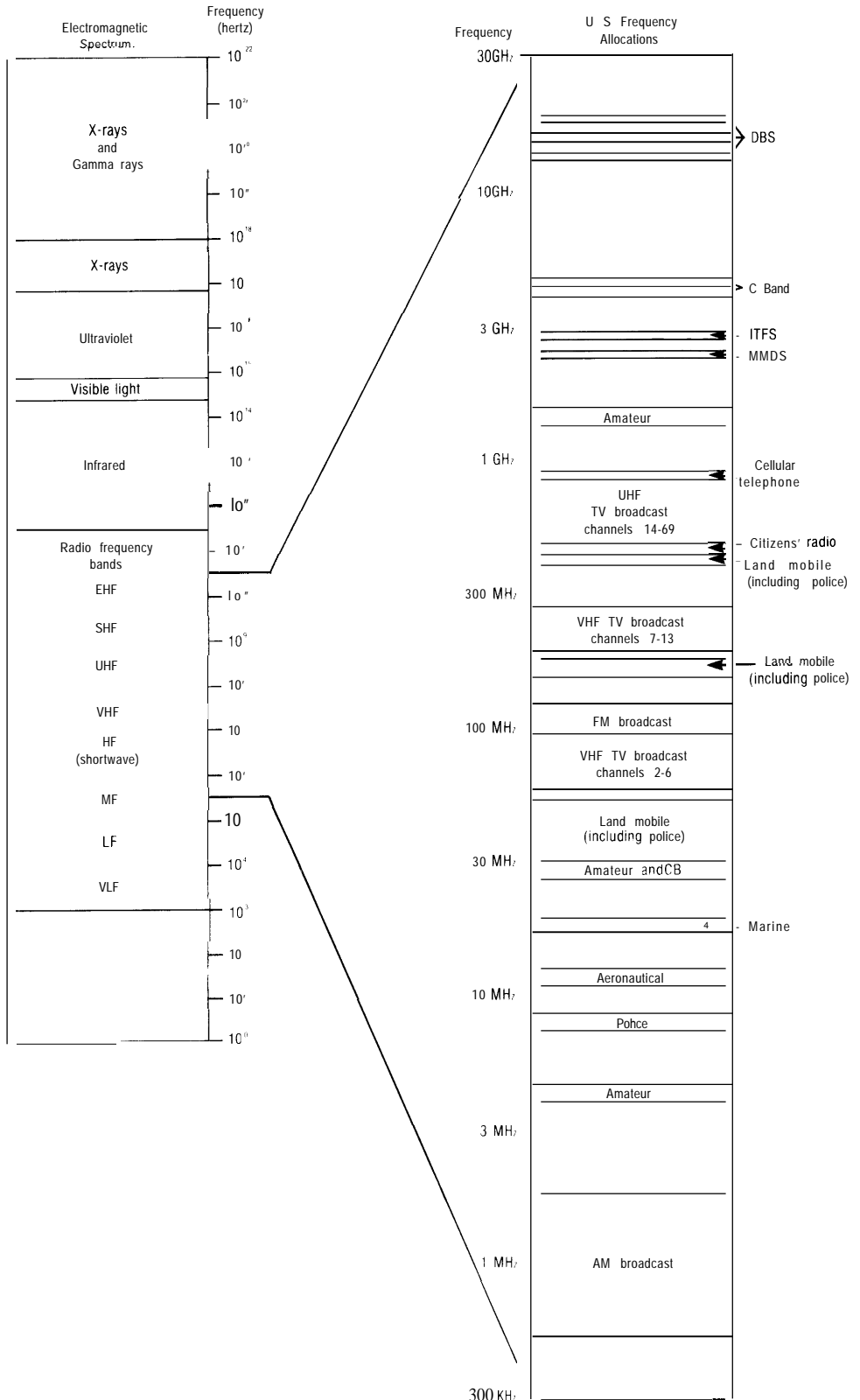

SOURCE: Adapted from: *Encyclopedia Americana*, vol. 23, 1986, p. 160; and FCC Rules, 47 CFR 90 to 100.

Figure 3-5—Map of a Cellular Radio System

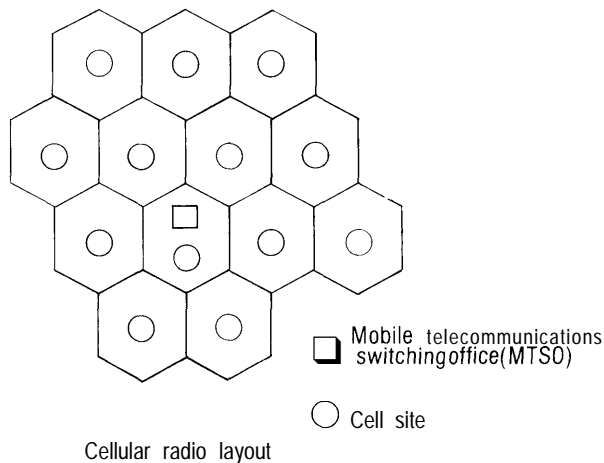

SOURCE: William Stallings, *Data and Computer Communications* (New York, NY: MacMillan Publishing Co., 1985). Used with permission.

cellular phones. Digital cellular, now coming on the scene, promises to improve spectrum utilization even more.

A cellular system can grow to meet demand. Initial service to a metropolitan area might require a few large cells. As demand grows, cells can be subdivided and distant cells can use the same frequency. The system is quite flexible, but there are limitations.⁵

The FCC has allocated 50 MHz in the UHF region of the spectrum to the mobile telephone service. This spectrum is subdivided into 832 pairs of 30 kHz bands (two-way conversations require one pair). Overall, this is sufficient capacity to handle the roughly 3 million users in the United States today, but there is significant congestion in some areas. In Los Angeles, New York, and Washington, DC, the cellular channels are overloaded during peak times.⁶ Faced with an explosion in demand for cellular service and little prospect for acquiring additional frequencies, the industry is focusing on technologies that will use the assigned frequencies more effi-

ciently. The most promising is end-to-end digital transmission, which is being adopted as an industry standard.

Digitization will increase the capacity of the assigned spectrum by as much as three to eight times or 9 to 24 million calls. The cost of conversion could be more than \$4 billion.⁷ Trends toward miniaturization leading to pocket-size cellular phones could boost demand even further.⁸ Some industry analysts believe that cordless, mobile telephones may be the trend of the future, and that if provided sufficient spectrum for expansion, they could be substantial competition for the local telephone companies.⁹

With the prospect of advanced TV (ATV) services looming in the future, competition between ATV and cellular for the UHF TV bands will heighten. Both services may suffer spectrum compaction at that point unless technology can improve the efficiency of spectrum use or new transmission schemes are devised.

SATELLITE COMMUNICATIONS

Satellite systems are long-distance links for telephone, data, and television transmissions to distant ground-based stations. Although currently used primarily for feeds to broadcast stations and cable systems in the United States, another generation of satellites called Direct Broadcast Satellites (DBS) could be used to beam HDTV signals directly to home viewers in the future. Japan and European countries are planning to use DBS to deliver HDTV. The Japanese are introducing HDTV via DBS as a new service, and not as a replacement for NTSC, which will continue to be broadcast terrestrially.

Satellites are “parked” in geostationary orbits 22,000 miles above the Earth—about one-tenth the distance to the Moon. By staying in the same position, their “footprint” (area of coverage) remains the same. Time delays for signals to and from Earth at that altitude disturb voice communications, but have no practical effect on video signals.

⁵Dale N. Hatfield and Gene G. @ “The opportunity CoStSof Spectrum Allocated to High Definition Television,” paper presented at The Sixteenth Annual Telecommunications Policy Research Conference, Airlie House, Airlie, VA, Oct. 30 to Nov. 1, 1988; William Stallings, *Data & Computer Communications* (New York, NY: MacMillan, 1985).

⁶Industry analysts forecast that by 1995 there will be about 20 million cellular phones compared to 2.6 million in service today. See “Cellular phone Industry’s Numbers,” *Washington Post*, June 8, 1989, p. E1, E6.

⁷Calvin Sims, “Meeting Mobile Phone Demand,” *New York Times*, July 19, 1989, p. D1.

⁸Frank James, “Battle of Miniature Cellular Telephones Heat Up with Launch of Motorola Model,” *Wall Street Journal*, May 5, 1989, p. B1.

⁹Hatfield and Ax, op. cit., footnote 5.

Fixed Satellite Services (FSS)¹⁰ are assigned orbital positions in space with separation between satellites arranged to minimize interference according to power levels and frequencies.¹¹ Spacing requirements limit the number of satellites in orbit for each band to about 40 for FSS or 8 for DBS.¹²

Satellite transponders receive signals at one frequency and relay them to Earth on a second frequency. The FCC has allocated 1 GHz of bandwidth in the spectrum (500 MHz for the uplink (ground to satellite) and 500 MHz for the downlink (satellite to ground). C-band satellites were the first domestic satellites in operation and carry the majority of satellite voice, data, and video communication. The Ku-band and the Ka-band (when operational) will carry increasingly more traffic.

The FCC regulates the broadcast power of C-band transponders to reduce the potential of interference with terrestrial communications, e.g., point-to-point microwave links.¹³ Low power requires the use of large receiving dishes (C-band antennas are 10 to 12 feet in diameter). Antenna efficiency is improving through new technology, and 4-foot diameter antennas are now used for TV terminals.¹⁴

Ku-band transponders operate at higher frequencies than are commonly used for terrestrial communication, so the FCC allows them to operate at higher power. Higher power allows the use of smaller receiving dishes (3 feet in diameter), but the higher frequencies are subject to interference from rain and other atmospheric conditions.

There are currently no high-powered DBS TV services in the United States. The FCC promulgated

regulations for DBS in 1982, but the medium has faced economic uncertainties that have slowed development. ¹⁵ This situation dramatically changed recently with the announcement of a partnership to establish a DBS system for the United States by as early as 1993.¹⁶

DBS can be received on antennas of 1 foot in diameter. This scale-down could overcome some of the objections and limitations imposed by some municipalities on Television Receive-Only (TVRO) home satellite dishes that receive low-power signals from the C-band satellites. Others argue that cable companies installed plant and equipment in urban areas minimizes the incremental cost of adding new customers or HDTV programming and limits DBSS advantage to largely rural areas.¹⁷

COAXIAL CABLES

Coaxial cables are widely used for distributing television to subscribers.¹⁸ About 80 percent of American homes have access to cable TV, and 55 to 60 percent currently subscribe.

Cable TV systems generally use a cable trunk that carries up to 80 frequency division multiplexed analog video signals. Taps from the coaxial trunk are fed to each subscriber. Signal strength in the trunk diminishes with distance. Therefore, analog amplifiers are placed at regular intervals within the system to boost the signal strength; but each amplifier adds noise to the signal. To avoid excessive loss of picture quality, cable operators limit the length of the trunk system. Improvements in amplifiers and their closer spacing might increase coaxial cable bandwidths up to 1 GHz.¹⁹

¹⁰There are several classes of FSS satellites operating at different frequencies and different power levels, e.g., C-band (4/6 GHz), Ku-band (11-12/14 GHz), and in the future, Ka-band (20/30 GHz).

¹¹Assignment of Orbital Locations to Space Stations in the Domestic Fixed-Satellite Service, 50 Fed. Reg. 35228 (1985).

¹²This represents the number of satellites that can cover between about 60 to 140 degrees longitude across the United States. Fewer satellites would fit into the range of 85 to 130 degrees longitude that provides full useful coverage.

¹³Timothy Pratt and Charles W. Bostian, *Satellite Communications* (New York, NY: John Wiley & Sons, 1986); and Charles W. Bostian, Virginia Polytechnic Institute, personal communication, Sept. 29, 1989.

¹⁴Harry Jessell and Peter Lambert, "The Uncertain Future of DBS," *Broadcasting*, Mar. 13, 1989, p. 42.

¹⁵See "DBS Viability Questioned," *TV Digest*, July 31, 1989, p. 8; David Rosen, "The Market for Broadband Services via Fiber to the Home," *Teleomatics*, May 1989, vol. 6, No. 5.

¹⁶John Burgess, "Satellite Partnership Plans Pay-TV System," *Washington Post*, Feb. 22, 1990, p. E1.

¹⁷John Sic, TeleCommunications, Inc., personal communication, Oct. 12, 1989.

¹⁸Coaxial cables have a central copper wire surrounded by an insulator with a finely braided copper shield around the outside of the insulator. The unit is encased in plastic or rubber armor. The concentric geometry allows higher frequencies to be carried than can pairs of copper wire. Most coaxial cable systems now in use have bandwidths of about 300 to 400 MHz, and some go as high as 550 MHz. This is sufficient to carry 35 to 80 video channels. See, Trudy E. Bell, "The New Television: Looking Behind the Tube," *IEEE Spectrum*, September 1984, p. 53.

¹⁹Dale Hatfield, Hatfield Associates, Inc., personal communication, Oct. 12, 1989.

Many cable operators are considering replacing the “backbone” of their cable system with optical fiber.²⁰ This would greatly reduce the number of existing **amplifiers** between the cable headend and any customer and correspondingly improve signal quality and channel capacity.²¹ This could, by some estimates, be achieved for as little as \$50 to \$75 per **subscriber**.²² This comparatively inexpensive upgrade of the system by the addition of an optical fiber backbone might provide today’s cable TV operators a significant performance and cost advantage over potential competitors (such as the telephone companies) in distributing HDTV in the near- to **mid-term**.²³ Such a system might not easily evolve into a two-way broadband system supporting interactive services as a fully **fiber-based** telephone system would.

A broadband telephone network is not likely to be widely available for 20 or more years, however, and some believe that an integrated cable TV-telephone network may provide some of the advantages of an interactive broadband system in the **interim**.²⁴ Today’s telephone network using **N-ISDN** can provide **sufficient** capacity for many information services (but not high-quality video) and the coaxial cable network can provide one-way distribution of high-quality video entertainment, possibly even called up over the telephone network. Whether such a **cable/telco** system is an evolutionary dead-end that slows or prevents the development of a fully switched broadband network by **skimmin**g off the most lucrative services or is an important interim step in the development of such a broadband network must be carefully considered.

COPPER TELEPHONE LINES

Often referred to as “twisted pairs,” the telephone lines leading into nearly every residence and

business are the backbone of the telephone system. A number of twisted pairs are combined into a “cable system,” and these cables may be bundled into several rope-like “binder groups” (screened cables). These are currently being replaced by optical fibers between large central telephone switches and in high-traffic sections of the long-distance network. The economies resulting **from** the immense carrying capacity of optical fiber are driving the substitution of fiber for copper. Fiber is on the threshold of being cheap enough to replace copper to the home **in** new, high-density residential developments. As many as 250,000 homes are projected to be **connected** by fiber by the year 1992.²⁵ Its penetration into existing residences and low-density areas will be **slower** because of its higher cost in these applications.

The information carrying capacity of a twisted pair is limited to typically just a few hundred **kHz** to a few MHz, depending on the distance between analog or digital repeaters along the line. The bandwidth for an analog (voice) signal on a telephone is much more limited still. It is normally specified to range from about 0.3 to 3.1 **kHz**. This range is restricted so as to limit the amount of information transmitted by the many calls being carried at any one time in certain portions of the telephone network, such as the microwave links used for long-distance calls. This increases the number of calls that can be handled.

The capacity of a twisted pair for transmitting digital data varies considerably according to the efficiency of the encoding, modulation, and multiplexing processes, and to the amount of noise and interference on the line. Telephone line modems for today’s analog system with transmission rates of 9.6 thousand bits per second (**kbps**) are now common

²⁰A recent poll of cable television MSO and system managers found that two-thirds expect fiber to replace coaxial cable in their networks. “Fiber Optics Handbook,” *Cablevision*, Apr. 24, 1989.

²¹Robert Pepper, “Through the Looking Glass: Integrated Broadband Networks, Regulatory Policies and Institutional Change,” 4 FCC Rcd 1306, 1307 (November 1988); U.S. Department of Commerce, National Telecommunications and Information Administration, *Telecom 2000*, NTIA Special Publication 88-21, October 1988, p. 268.

²²Hatfield, op. cit., footnote 19; David P. Reed and Marvin A. Sirbu, “Integrated Broadband Networks: The Role of the Cable Companies,” 1989 Telecommunications Policy Research Conference, Airlie House, Airlie, VA, Oct. 1-3, 1989; “Fiber Optic: Backbone for CATV,” *IEEE Spectrum*, September 1988, p. 26. Note that the various estimates of cost correspond only to within a factor of 2.

²³Bruce L. Egan and Douglas A. Conn, “Capital Budgeting Alternatives for Residential Broadband Networks,” Center for Telecommunications and Information Studies, Graduate School of Business, Columbia University, October 1989.

²⁴John Sic, Telecommunications, Inc., “Proposal for Telco/Cable Interface,” paper presented at the Telecommunications Reports’ Conference on Telco-Cable, Washington, DC, Sept. 22, 1989.

²⁵John Markoff, “Here Comes the Fiber-Optic Home,” *New York Times*, Nov. 5, 1989, sec. 3.

and rates twice this are becoming **available**.²⁶ Analog transmission over twisted pairs will continue to be the principal technology for the midterm, although Integrated Services Digital Network (**ISDN**) are gradually being installed in some areas, primarily for business service.

ISDN can carry voice, data, and video information over switched telephone networks in a digital format. It is a set of transmission, switching, and signaling technologies that support advanced digital services.²⁷ **ISDN** was designed to use existing subscriber loops consisting of copper pairs for digital transmission. The Basic Rate Interface (**BRI**) of 144 **kbps** specifies two 64 **kbps** channels for subscriber use and a 16 **kbps** channel for signaling and some slow-speed digital subscriber service.

Most homes today are wired with two pairs of twisted copper lines. When using the full capacity of **N-ISDN**, these two pairs will be able to carry data rates of 1.544 Mbps.²⁸ This rate is sufficient for a variety of interactive digital computer information services, but is not able to deliver real-time, **high**-resolution video services. By “compressing” the digital signal (see box 4-2), it is possible to transmit a modest quality video signal for **teleconferencing**.²⁹ For conventional TV, ATV, or HDTV, higher capacity transmission media are required, e.g., coaxial cable or optical cable.

The public telephone network could be an important medium for delivering HDTV to the home. The goal of “universal service” set forth in the Communications Act of 1934 is nearly a reality. It permits point-to-point routing for voice services through a switched network³⁰ to nearly all residences and businesses in the United States. It provides two-way communication, which could be an important attribute should HDTV evolve into an information

“appliance” for the interactive exchange of information.

Large investments will be needed if the telephone network is to provide the bandwidth and switching necessary for carrying real-time, high-resolution, full-motion video. If this is to happen, optical fiber technology and optoelectronic switching devices will hold the key.

OPTICAL FIBER CABLES

Fiber optics technology enables **information**—voice, data, and **video**—to be transmitted as light pulses through glass fibers. Optical **fibers have** many advantages over cables and wires. These include wider bandwidth and longer spacings between repeaters, lower weight, immunity to electrical interference, higher reliability, and lower maintenance costs.³¹ Because of this, shielding is not required for fiber to meet FCC requirements. Glass fibers do not conduct electricity, thus a lightning strike cannot send a pulse down a fiber to cripple equipment on the network.

Because optical fibers do not conduct electricity, providing power to the system on the customer’s premises may require using the customer’s power source. This would likely not be as reliable as today’s conventional system where backup power is provided by the central telephone exchange. Using rechargeable batteries on the customer premises could provide backup power **in** the event of an outage, but might lead to significant maintenance problems. Fiber systems are still more expensive than copper pair systems,³² but costs are coming down rapidly.

An optical fiber transmission system includes one or more optical fibers housed in a protective cable, and devices for converting electrical signals into light pulses and back again. Repeater devices are used to

²⁶L. Brett Glass, “Modern Modem Methods,” *Byte*, June 1989; Eli Noam, “The Political Economy of ISDN: European Network Integration vs. American System Fragmentation,” Apr. 23, 1986, p.5; “V.32 Modems,” *High Technology Business*, November-December 1989, p. 45.

²⁷There are two generic forms of ISDN; Narrow band ISDN (N-ISDN) that can carry voice or data within its bandwidth, and broadband ISDN (B-ISDN) with sufficient bandwidth to carry high-resolution full-motion video but requires coaxial cable or optical fiber in addition to a wide-band switching network. See David Hack, *Telecommunications and information-System Standardization—Is America Ready 87-458* (Washington, DC: Congressional Research Service, 1987).

²⁸The T1 rate of 1.544 Mbps was chosen based on the typical distance between manhole covers—where analog or digital repeaters \$113 Or can be placed in the current telephone system. Bob Mercer, Hatfield Associates, Inc., personal communication Nov. 13, 1989.

²⁹Richard Doherty, “System Puts Real-time Squeeze on Color Video,” *Electronic Engineering Times*, Feb. 27, 1989.

³⁰Only circuit-switched systems will be discussed here. Packet-switched systems and others are also possible.

³¹Pepper, op. cit., footnote 21.

³²J.E. Duffer, “When Does Fiber Make Sense?” *Business Communications Review*, February 1989.

regenerate the signal over long distances, and multiplexing can be used to increase the carrying capacity of fiber links (see box 4-2). Data rates of 565 Mbps (8,064 voice channels) on optical fibers are common; rates of 1.76 Gbps are available;³³ and experimental systems have reached 16 Gbps.³⁴ Technologies to achieve much higher rates are being researched.

The versatility and technological capacity of optical fiber makes it superior to copper in many ways. Its bandwidth suits it to the transmission of HDTV signals as well as high-volume telephone trunk circuits. Many long-distance lines have been converted to optical fibers, but little fiber has been installed in the local telephone loops. A number of optical fiber demonstrations to residential subscrib-

ers have been undertaken in selected municipalities by the Bell Operating Companies and others, including: Heathrow, Florida (BellSouth); **Perryopolis, Pennsylvania** (Bell Atlantic); and **Cerritos, California** (GTE).³⁵

The cost of broadband switching equipment and rewiring the local loop to existing buildings will delay widespread installation of fiber to residences. It may take 20 years or more before fiber becomes common in households. There **are** currently few services that demand broadband telephone service to residential subscribers. Telephone companies view the delivery of video dial-tone services and the potential delivery of HDTV to the home as an important driving force for the installation of fiber over the "last mile."

³³Jonathan Kraushaar, "Fiber Deployment Update," FCC, Common Carrier Bureau, Industry Analysis Division, Feb. 17, 1989, p. 3.

³⁴Miyoko Sakurai, "Semi 'Trailblazer,'" *Electronic Engineering Times*, Feb. 20, 1989.

³⁵Paul W. Shumate, Jr., "Optical Fibers Reach Into Homes," *IEEE Spectrum*, February 1989; Herb Brody, "The Rewiring of America," *High Technology Business*, February 1988; Michael Warr, "Southern Bell Switched-video Plans on Track," *Telephony*, May 15, 1989, p. 11.

TV and HRS Technologies

INTRODUCTION

As an entertainment medium, HDTV is not revolutionary. It is simply another step in the ongoing evolution of television that began with black and white (B&W) TV in the 1940s and will continue into the future with as yet undreamed of technologies. Each successive generation of TV technology attempts to provide a more realistic picture and sound within the constraints of low-cost, easy-to-use consumer technology.

Here we describe conventional NTSC¹ television, Advanced Television (ATV) systems, and some of their underlying technologies (box 4-1). The convergence of ATVS, computer and telecommunications equipment toward High Resolution Systems (HRS) is discussed later.

CONVENTIONAL TELEVISION: PRODUCTION, TRANSMISSION, AND RECEPTION

Television systems involve three distinct activities: 1) production, 2) transmission, and 3) display of the TV program.

TV cameras begin the process by creating, for each of the three primary colors (red, green, blue), an electronic signal proportional to the brightness of light at each point of a scene. This signal is transmitted immediately or recorded on magnetic tape for later use.² The quality of the transmitted picture is determined by the range of frequencies—“bandwidth”—that can be used, and by the efficiency with which the video signal is encoded and then modulated onto this bandwidth.³ At the receiver, the transmitted signal is reconverted to a

picture on the TV screen by scanning electron beams (one for each primary color) across the picture tube and varying their intensity in exact synchronism with the original picture signal.

The 1950s technologies used today to bring color TV pictures to the home have a variety of shortcomings and imperfections that modern systems can correct. TV production formats, established in the 1930s and 40s, were originally based on 35-mm motion picture film. This gave today's TV picture its nearly square shape (or aspect ratio) of 4 units wide by 3 high (4:3). Research has found, however, a strong viewer preference for screens 5 to 6 units wide by 3 units high—as seen in today's theatres—that correspond to the human field of vision.⁴

The original motion picture standard was 16 pictures per second—manually cranked cameras could go no faster.⁵ At that rate the viewer saw a significant ‘flicker’ in the picture displayed (hence the term, the ‘flicks’).⁶ In developing TV transmission standards, engineers sought a system that sent pictures often enough that viewers did not see them flickering, yet did not send so many that the needed bandwidth (information carrying capacity) was excessive. The effective picture resolution (or ability to show detail), its color fidelity, and its range of brightness were all limited in order to meet these bandwidth constraints.

Other shortcomings of today's NTSC system include: the blurring of bright colors around the edges; the generation of rainbow colors where brightness varies rapidly, such as striped shirts; and susceptibility to “ghosts,” snow, interference from other stations, and image distortions.

¹National Television Systems Committee—the group that formulated the B&W and color TV standards in use in the United States today.

²Program production includes, of course, editing, the insertion of special effects, audio, etc.

³For terrestrial broadcasters, the available bandwidth is set by the Federal Communications Commission (FCC), which brokers competing claims for the limited radio-frequency spectrum.

⁴Lee McKnight, W. Russell Neuman, Mark Reynolds, Shawn O'Donnell, and Steve Schneider, “The Shape of Things “come: A Study “ Subjective Responses to Aspect Ratio and Screen Size,” ATRP-T-87, MIT Media Lab, May 17, 1988.

⁵Richard J. Solomon, “Broadband Communications as a Development Problem,” International Seminar on Science, Technology and Economic Growth, OECD, June 6, 1989, Paris. This was later increased to 24 frames per second to give better sound quality.

⁶Cary Lu, “High Definition TV Comes At A High Cost,” *High Technology*, July 1983, p. 45.

Box 4-1—Inside Today's NTSC Analog Television

The production of a TV show begins with a TV camera. TV cameras separate the primary colors—red, green, and **blue**—of the scene with optics and filters and then focus the scene for each color on separate sheets of light-sensitive material. This material generates an electric charge that varies in size by the amount of light that falls on it. The charge on this sheet is then used to control an electron beam that scans across the sheet **from** left to right and top to bottom—just as we read text. By this means, three “electronic” pictures are formed, one for each color, every 1/30th of a second.

The three pictures thus formed consist of 483 active lines vertically. Each line has the equivalent of about 427 horizontal picture **elements**.¹ An additional 42 vertical lines and the equivalent of 82 horizontal picture elements could, in principle, be displayed. **Instead**, the time is allotted to generating vertical and horizontal synchronization, or sync, signals. These sync signals note the beginning of each new picture and of each horizontal line within the picture.

This electronic picture is encoded into a composite signal, including brightness, color, and sound. The composite then modulates the amplitude of a carrier (corresponding to a particular TV channel) which is transmitted over-the-air, through cable, or by other means. To be compatible with **B&W** TV, the brightness (luminance) signal transmitted is a complicated mix of the Red, Green, and Blue signals and corresponds to the relative sensitivity of the eye to these different hues. The “color” signal (**chrominance**) contains the rest of the information needed for the receiver to decode these combined signals back into the primary colors.

At the home, the transmitted signal induces a tiny voltage in the TV antenna or provides it directly via cable. The electronic picture, or video signal, is separated from the carrier and amplified. The same sync signals used by the camera now tell the receiver when to start scanning the electron beam across the inside surface of the picture tube for each new picture, as well as for each horizontal line composing the picture. As the electron-beam smoothly scans across the picture tube, its intensity is varied according to the brightness of the image as originally measured by the TV camera, and is thus reproduced on the phosphors of the picture tube. Color TVs do this simultaneously with three different electron-beams, one for each color of phosphor. This type of electronics, where the information content is represented by a continuously varying voltage or current, is known as analog electronics.

This system is much like writing on a blackboard at a distance using a set of strings to pull the pen back and forth. What is written onto the camera is reproduced on the picture tube. If there are errors in the transmission process, they are likewise written onto the TV screen at the other end. With the picture information carried by a continuously varying voltage, it is very difficult to tell if an error has crept in, let alone correct it.

Such a system was all that 1950s electronics technology was capable of. This approach carries with it a variety of impairments, including the use of interlaced scan, errors in displaying colors, an excessive susceptibility to transmission degradations, and inefficient use of the broadcast spectrum.

In developing TV transmission standards, engineers had to send pictures often enough that viewers did not see them flickering, yet did not send so many that the needed bandwidth, or information carrying capacity, was excessive. Both of these were accomplished by showing each picture twice using an “interlaced scan” technique. First, the odd horizontal lines (numbered consecutively from top to bottom) of the picture are sent; next, the even lines are sent. In this way, the 525 lines of today’s TV (**NTSC**) set are displayed half (or a field) at a time, 1/60th of a second apart. An entire picture, or frame, is then seen every 1/30th of a second—minimizing bandwidth and flicker simultaneously.

Although the vertical resolution of such a picture could be 483 lines, it is normally much lower than this. As one example, when an interlaced scan system displays an odd horizontal line as black and the even line next to it as white, there can be an annoying flicker to the picture every 1/30th of a second—easily perceivable by viewers. Consequently, the vertical resolution of the studio camera was reduced to, at most, 330 lines (by

¹**Analog TV does not really have discrete horizontal picture elements, but rather a continuous horizontal scan. The equivalence here is based on the scanning times and picture resolution.**

changing the spot size of the scanning e-beam within the camera) and the horizontal resolution was reduced by roughly the same amount. Progressive scan systems, in which every line is sent, odd or even, in a single pass down the picture do not suffer this problem of flicker and can thus give much higher effective resolutions for a given line count.

The transition in the 1950s from B&W to color was achieved by reducing the resolution of the brightness signal and inserting a color signal as described above. This led to a slightly lower resolution for B&W TVs, among other problems. For color TVs, the manner in which the color and brightness signals were intermixed could cause bright colors, especially red, to blur at the edges; and places where the brightness varied rapidly, such as striped shirts and checked jackets, to degenerate into rainbow colors.

In the past, the interference between the brightness and color signals was minimized by further reducing the resolution of the receiver's circuits—to about 250 lines horizontal resolution. In 1978-79, *special* circuits (comb filters) were introduced which allowed more of the entire range of brightness to be displayed; in 1984, other special circuits were introduced that allowed the entire range of colors to be displayed with somewhat less susceptibility to the above degradations.

Other errors, or artifacts, in today's TV picture are also widely noted. Viewed up close, today's NTSC TV looks like an ant's nest with the dots and lines "crawling" around the picture. These are again due to the manner in which the color and brightness signals are intermixed and subsequently decoded by the receiver. Under certain conditions, NTSC sets have a tendency to switch between different colors. For this reason, the NTSC system has sometimes been disparaged as Never-Twice-the-Same-Color.

The NTSC system is also highly sensitive to transmission degradation. When the broadcast signal reflects off obstacles, viewers may see 'ghosts' and if reception is weak, viewers may see 'snow' or noise.

Finally, the NTSC system uses the broadcast spectrum inefficiently. These old electronics technologies and the use of **low-quality** home antennas required very strong sync signals to ensure proper operation. Further, the signals transmitted by broadcasters are all in the same **format**.² Because of this, TV stations cannot be operated on adjacent channels within the same geographic region without visibly interfering with each other. Thus, in the VHF band (channels 2-13) stations are separated by one blank 'taboo' channel; in the UHF band, stations are separated by as many as five taboo channels. These channels have not been usable for other purposes. Improved **antennas**, and **perhaps** other changes, might enable significant reductions in the channel and geographic separation requirements at a very small cost. This would enable closer packing of TV channels and might save spectrum for other purposes, but has not been required by the FCC.

Even within the normal 6-MHz bandwidth of a single channel the NTSC signal makes inefficient use of the available spectrum. Much of the available spectrum corresponding to extreme brightness or the most vivid colors, for example, is rarely used. It was such a "hole" in the spectrum that allowed the original B&W NTSC standard to be turned into a compatible color system. By slightly reducing the maximum B&W resolution, all of the color information could be squeezed in. Similarly, the EDTV proposals today offer alternative means of further exploiting NTSC's poor bandwidth use³ to provide higher resolution and a wider screen without requiring a wider channel bandwidth.

Although the NTSC system has many shortcomings, it was a remarkable achievement in its day. The engineers that developed NTSC were working at the very limits of analog technologies in the 40s and 50s, with an overriding constraint to make the receivers as low cost as possible. Their remarkable achievements resulted in a system that has served us well for 40 years. With today's technologies, however, we can do better.

References: "Television Engineering Handbook," K. Blair Benson (ed.); Trudy E. Bell, "The New Television: Looking Behind the Tube," *IEEE Spectrum*, August 1984; Ronald K. Jurgen, "High-Definition Television Update," *IEEE Spectrum*, April 1988; personal communications: Andrew Lippman, MIT, Aug. 16, 1989; William Schreiber, MIT, Oct. 12, 1989; John Henderson, Sarnoff Labs, Oct. 12, 1989.

²The signals are transmitted in the same raster scanned format as generated by the camera. Consequently, they are coherent.

³Other inefficiencies in spectrum use by NTSC include: the vertical and horizontal retrace intervals, during which additional picture information could be sent; the manner in which the carrier is modulated, including the use of a separate sound carrier; and the transmission of the entire picture in every frame, including redundant information within and between frames.

ADVANCED TELEVISION SYSTEMS: IDTV, EDTV, HDTV

Modern computer-like digital electronics can reduce many of the defects found in today's **NTSC** system. Three levels of improvement in television technology are either now under advanced development or are entering commercial markets.

The first level is Improved Definition TV (**IDTV**). IDTV receivers take the standard broadcast and convert the continuously varying, analog voltage of the **NTSC** transmission into a digital signal. This digital signal represents the information content of the picture as a series of numbers specifying the color and brightness of each point in the image. A simple example of analog-to-digital conversion is shown in box 4-2.

The advantage of converting the analog broadcast to a digital signal within the receiver is that the picture information can then be manipulated (modified, adjusted, corrected, etc.) by digital signal processing techniques and/or stored in memory. This is similar to the way computers manipulate and store data. Special techniques can be used to reduce flicker, ghosts⁷, snow, and other picture imperfections, and to improve apparent resolution and color. NA Philips (Netherlands) began marketing **IDTVs** in the United States in the spring of 1989.

Extended Definition TV (**EDTV**) is the next step in the evolution of TV technology. It requires modest improvements in today's TV transmissions and small changes in the broadcast standards. The improved TV signal will still be compatible with today's TVs, and it will not carry so much additional information as to require greater bandwidth than is available in today's 6-MHz TV channel.

EDTVs will use digital memory and signal processing techniques. In most proposals **EDTV** provides a **widescreen** picture and somewhat higher resolution than is now possible. Japan was scheduled to begin **EDTV** broadcasts in 1989, and Europe plans to do so in 1990. Some believe that the improvements in TV picture possible from **IDTV** and **EDTV** will significantly reduce the future market for **HDTV** (ch. 6).

High Definition TV (**HDTV**) is the third major step up from today's **NTSC** system. **HDTV** is typically portrayed as having roughly twice the vertical and horizontal resolution as is theoretically possible for current TVs; a **widescreen** picture (aspect ratio of at least **5:3**) displayed on a large screen; better color; and compact disk (**CD**)-quality digital sound. The much higher quality pictures of **HDTV**, however, will require the transmission of substantially more information than current TV systems. The original Japanese **NHK** production system, for example, required 30 **MHz of bandwidth**—the equivalent of five TV channels. To reduce this to manageable proportions, a number of tricks are used, beginning with an analysis of what the human eye can actually perceive.

VISUAL RESPONSE AND HIGH DEFINITION TV

Human vision responds rapidly to the gross details of bright or moving objects, particularly in peripheral vision, but does not perceive their fine detail or color well. Conversely, to perceive fine details or color requires the object to be stationary for longer **periods**—or for the eye to track a slowly moving object and “freeze” it on the retina. Thus, efforts to avoid flicker by transmitting all of the color and detail of both moving and stationary images at the same **maximum** rate, i.e., 60 pictures per second (as an analog TV would), are unnecessary; the eye cannot perceive all of it.

The groups developing **HDTV** systems have used knowledge gathered in experimental work on visual perception to reduce the picture information that must be transmitted. Digital processing techniques are used to send the picture in low resolution at a rapid rate so that rapidly moving portions of the picture are seen quickly; and to also send the picture in high resolution and full color at slower rates so that the still portions can be seen in **detail**.⁹ The TV receiver then uses digital signal processing techniques to reconstruct the picture in memory, from which it is flashed onto the screen 60 times a second.

These techniques reduce the bandwidth required to transmit the TV picture to a fraction of **that of** the

⁷Ghost cancellation usually requires adding a special test signal to the transmitted signal.

⁸To transmit this information may require a combination of greater bandwidth, much more efficient encoding and modulation techniques, various digital compression techniques, and good signal to noise ratios, among others.

⁹William F. Schreiber and Andrew B. Lippman, “Bandwidth-Efficient Advanced Television Systems,” MIT Media Lab, no date.

Box 4-2—Inside Analog/Digital Television

The various proposals for advanced TV systems use combinations of analog and digital techniques to improve the picture seen on the receiver. The process of generating a picture is described in box 4-1. This process results in an analog signal coming from the camera—that is, with a continuously varying voltage or current proportional to the brightness of each point of the scene.

Selected portions or all, as desired, of the analog signal from the camera are then converted into a digital format for storage and/or transmission. In some cases, such as **IDTV**, the analog to digital conversion is only done in the receiver. A particularly simple example of analog to digital (A/D) conversion is Pulse Code Modulation (**PCM**).

The PCM process begins by sampling the continuously varying analog signal, as shown in figure 4-1. The sampling rate is usually at least twice the highest frequency of the analog signal. The result is a series of pulses whose amplitudes correspond to the analog signal at regular, discrete times.

These pulse amplitudes are next converted into numerical values by comparing them to a set of discrete amplitude steps. This does introduce errors, depending on how many discrete steps are used and how well the pulse amplitude matches the closest step. This error can be reduced by increasing the number of steps, but at the same time increases the circuit complexity and the amount of numerical information that must be transmitted.

The precision of this quantization is normally given by the number of steps used and is commonly cited in terms of the “bits” of binary information that result, each bit representing an additional power of 2 in the number of steps. Thus, 2 bits equals 4 steps; 3 bits equals 8 steps; 4 bits equals 16 steps; and so on. Some 256 steps, or 8 bits, are usually sufficient to encode the brightness information for each primary color—red, green, and blue—of a studio TV signal. This is a total of 24 bits.

The binary information representing the picture can now be stored in a computer-like memory, manipulated, or transmitted with little degradation. Each “bit” of information, for example, can be transmitted as either “on” or “off.” At the receiver, even if the amplitude of “on” was greatly reduced or distorted due to transmission problems, the receiver can usually still detect that it was “on” and correct its value to the nominal level. In contrast, an analog receiver normally has no way of knowing whether or not a signal is distorted. It can only reproduce what it receives, errors and all.

In two-way transmissions of data, such as by a modem, a digital signal can also include information that tells the receiver how to check for errors in the transmission. For example, eight bits of information could be sent with a “parity” bit. The “parity” bit is “on” if the number of 1s sent is even; “off” if the number of “1s” sent is odd. The receiver can check to see if the number of 1s received and the parity bit correspond. In this way, at least some of the transmission errors so serious as to cause “on” to appear “off” and vice versa can be detected. More complex techniques will be used to reduce the number of errors in transmitting HDTV pictures and to ensure the correct transmission of critical components of the signal.

Figure 4-1—Analog to Digital Conversion Using Pulse Code Modulation

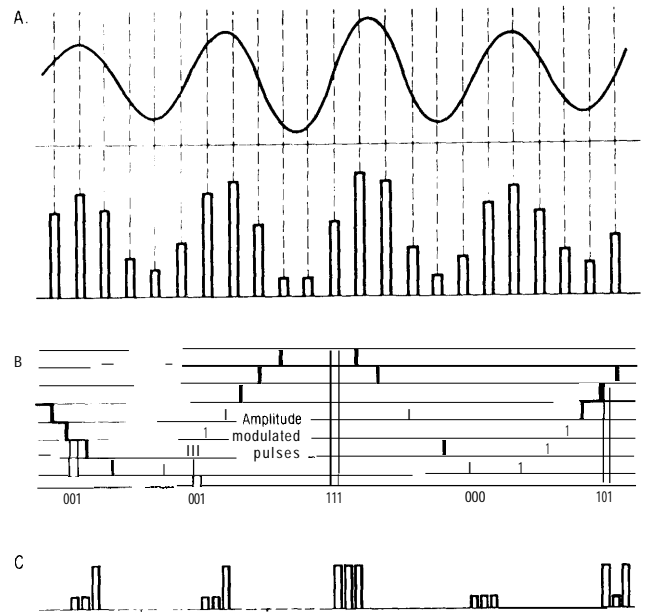

- A. The analog signal is sampled at regular intervals.
 B. The amplitude of these samples is then compared to a set of discrete amplitude steps and converted into numerical values. These values are shown written in binary.
 C. The numerical values can then be transmitted in a digital format. Information from other signals can be sent between these samples in a time division multiplexed format.

SOURCE: Kamilo Feher, *Advanced Digital Communications: Systems and Signal Processing Techniques* (Englewood Cliffs, NJ: Prentice-Hall, Inc., 1987). Used with permission.

(continued on next page)

Box 4-2—Inside Analog/Digital Television-Continued

The basic digital signal for an HDTV picture carries an enormous amount of information—as much as 1.2 billion bits per second (1.2 **Gbps**). In comparison, a phone conversation uses less than 64 thousand bits per second (64 **kbps**). A personal computer uses just 16,000 bits of information internally to represent a **screenful** of text and, on a standard monochrome monitor, just 250,000 bits are needed to display this text—which often remains unchanged for long periods while one ponders what to write next.¹ To transmit the total 1.2 **Gbps** of the HDTV signal requires far more bandwidth than is available in all but the most advanced fiber or short-haul cable systems. Thus, digital signal compression techniques are used to make transmission to households practical.

Digital signal compression eliminates the redundant information in a signal. For example, a large expanse of blue sky in a picture carries little or no new information from one point to the next. Special “**intraframe**” compression techniques effectively tell the receiver that these picture elements are the same, and allow the repetitious “blue sky,” “blue sky,” . . . information to be eliminated.

Similarly, the stationary portions of a picture do not change from one frame to the next. There is no need to transmit such redundant information 60 times per second in full detail. In fact, if nothing moves no new information need be transmitted at all. In this case, one frame is compared to the next to do “**interframe** compression” and only the differences are transmitted. Interframeprocessing, however, may result in other types of errors such as inaccurate depiction of moving objects.

As already noted, the eye is least sensitive to the color and detail of those parts of the picture which are moving. This information can be reduced simply by sending the rapidly moving portions at lower resolution.

Together, these techniques greatly reduce the information content of the transmitted signal and, in fact, make the transmission of HDTV pictures practicable. The Japanese MUSE HDTV system, for example, reduces the signal bandwidth from 60 to 8 MHz using such techniques.² Digital systems might reduce the information content from some 1.2 **Gbps** to 70-80 **Mbps**. Subsequently, the transmitted signal is decoded and turned back into a viewable picture in the receiver.

In some cases, it may also be desirable to fit additional information into the HDTV signal. This is illustrated in figure 4-1. This technique is known as “time division multiplexing” and is especially valuable in cases where the transmission media is filled close to capacity or is being used inefficiently.

TVs that use analog electronics alone cannot do this type of image manipulation. Because analog signals vary continuously, it is impossible to do such signal compression before transmission, to catch and correct transmission errors, to recreate the picture in memory at the receiver, to multiplex the signal, or to do a host of other advanced signal manipulations. Instead, purely analog systems are constrained to simply write the picture as transmitted directly on the screen, like chalk guided by a string.

References: Kamilo Feher, “Advanced Digital Communications”; “Television Engineering Handbook,” K. Blair Benson (ed.); William Schreiber, various papers, *op. cit.*; Submissions to the FCC, various. Dale N. Hatfield, “Report on the Potential for Extreme Bandwidth Compression of Digitized HDTV Signals,” Mar. 20, 1989; “Television Technology Today,” Theodore S. Rzeszewski (ed.). Other references as in box 4-1.

¹A screenful of text has 25 rows by 80 characters per row and 8 bits per character when handled as ASCII text internally. A standard graphics based monochrome monitor has 720 by 348 pixels, each either “on” or “off.” Assuming that the text on the screen remains unchanged, this requires 250,560 bits to represent. If the text was being changed at 60 times per second, the data rate would be 15 Mbits per second.

²This total is for the component signals—30 MHz for luminance, 15 MHz for Red, and 15 MHz for blue. Larry Thorpe, Sony Corp., personal communication, Oct. 12, 1989.

basic unprocessed analog signal. Only the use of these and other (box 4-2) digital signal processing techniques makes HDTV practical. Such digital signal processing, however, comes at a price. In general, the greater signal compression required to reduce the bandwidth, the greater the complexity and cost of the receiver’s electronics needed to

decode the signal. In large-scale production, today’s semiconductor technologies can minimize these added costs.

It is uncertain whether or not such visual tricks will work as well on the large screen that will likely be used for HDTV. Some note that, especially on large screens, the eye is able to track relatively

slow-moving objects and freeze them on the retina. In such cases, the digital signal processing might remove visual **information** that the eye does **perceive**—reducing the visual quality of the picture.

The most important attribute of an HDTV may be the much larger field of view it provides. The region of greatest visual acuity of the human eye is within the central one degree of the visual field. Viewers tend to move away **from** the screen to view moving objects in order to maximize the **action** of the image within this central one degree field, and stop when the details of the image begin to be lost. The ideal viewing position for an **NTSC** set (525 lines) is experimentally found to be roughly 7 screen heights **from** the receiver, providing the viewer an 8 by 11 degree field of view. For the typical HDTV system (1125 line Japanese system), the preferred viewing distance is found to be about 3.3 screen heights away, providing the viewer a 17 by 28 degree field of view. These are compared in figure 4-2.

Thus, viewers position themselves for roughly the same resolution on the eye, but they have a much larger viewing angle with HDTV, contributing to a sense of “**telepresence.**”¹⁰ Although the higher resolution and picture quality of HDTV would be visible on a smaller screen TV, there would be less incentive to purchase such an HDTV. It would not provide the same sense of **telepresence**, and many people would find it **difficult** to focus on or experience discomfort if close enough to benefit **from** the higher resolution.

“Telepresence” or the sense of “being there” is a potentially powerful market inducement for large screen, high resolution displays. An example of this sense might be the feeling, when viewing a very high-quality motion picture screen up close, of moving with the airplane or roller coaster when it makes a fast turn, or of unconsciously putting your foot on the **brake** to prevent an accident. In watching sports, it allows one to have a greater sense of being in the stadium itself—being able to watch clearly and in detail the entire scene of a quarterback completing a pass to a receiver, rather than relying

Figure 4-2—Comparison of the Field of View for an HDTV and Today’s NTSC TV To Have the Same Resolution for the Viewer

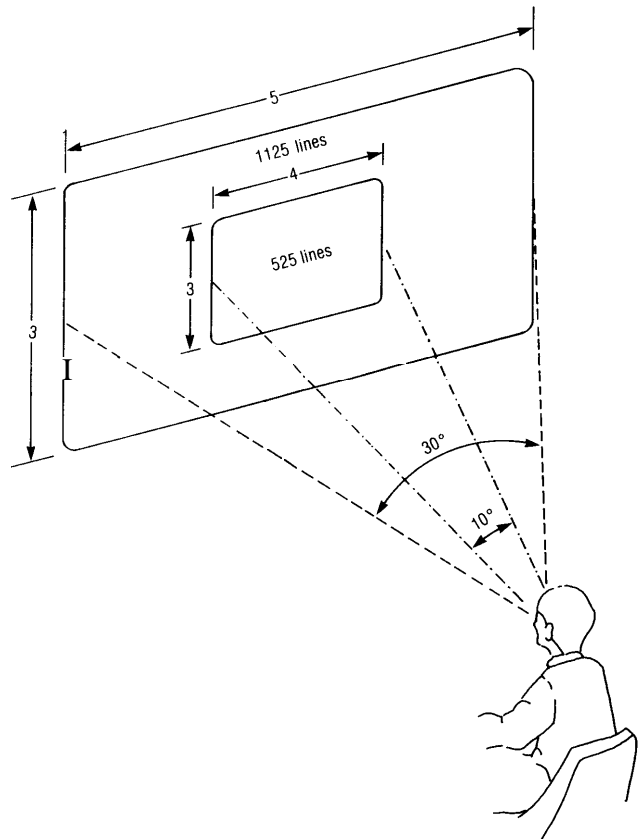

SOURCE: William E. Glenn and Karen G. Glenn, “High Definition Transmission, Signal Processing, and Display,” paper presented at the SMPTE Conference, San Francisco, CA, January 1989. Used with permission.

on instant replays of the separate tight closeups of the quarterback and receiver that are used today.

HDTV SYSTEMS: PRODUCTION, TRANSMISSION, RECEPTION

The key attributes of HDTV—twice the resolution of today’s television, a wider screen, truer color, and digital sound—will require significantly more information to be transmitted than is currently the case. This cannot be done while simultaneously remaining compatible with today’s **TV receivers** and channel bandwidths. Significant changes are necessary in production, transmission, and reception standards and equipment to achieve such high **definition** pictures.

¹⁰William E. Glenn, “High Definition Television,” Society for Information Display, 1988.

Production Standards

Today's production standards are based on 24 **frame** per second motion picture **film** or on video tape for television. Although the different world standards for color **TV—NTSC** (USA, Japan), **SECAM** (France, Eastern Europe), and **PAL** (Western Europe)—vary in their frame rate and number of lines **scanned**¹¹, equipment to convert **from** one standard to another (**transcoding**) with little loss in quality has been technically quite successful. The most **difficult** aspect of **transcoding** is to convert between formats with different **frame** rates. This requires interpolation between pictures in order to show motion smoothly. The conversion from interlaced **scanning** to progressive scanning has also been difficult.

Lower-cost and more flexible electronic video production systems will become increasingly important in coming years. Such systems will compete with **film** for many applications and complement cinema photography in cases such as special effects.

Each medium—**NTSC**, **HDTV**, and **film**—has its own artistic “look and feel” according to its technical characteristics and format. **NTSC** video tape, for example, can generate the afternoon soap opera’ look under various conditions. This is due to the sensitivity and response characteristics of the electronic camera used. The low resolution of **NTSC** systems also forces the program producer to emphasize closeups or tight shots of the actors.

In contrast, the greater sensitivity, color, and brightness range of film and the better match of film’s response to that of the human eye gives **film** a much more natural look for scenery; its higher resolution allows the producer to step back and use more wide-angle views. These characteristics give different artistic feels to the media, which are likely to persist well into the **HDTV** era.

In the longer term, however, electronic capabilities are likely to bring video media closer to the capabilities of film. In addition, electronic media offer advantages over **film** by eliminating processing and allowing, in the filly digital case, an endless

number of overlays of special effects or addition of other material. These potential new applications and cross-technology interactions highlight the importance of production standards.

Although it is now unlikely that a single world standard for **HDTV** production will be adopted (ch. 2), international program exchange standards may yet be developed that allow easy **transcoding from** one system to **another**.¹²

Transmission Systems

HDTV transmission systems must take into account a variety of media as well as different degrees of compatibility with existing receivers and channel requirements. Although the U.S. communications infrastructure includes cable, satellite, **VCRs**, and will someday encompass fiber to the home, terrestrial broadcasting has been the major focus for U.S. **HDTV** development. This is due to its market importance and the constraints it faces in spectrum allocation. The technical requirements for terrestrial broadcasting are also significantly different than for the Direct Broadcast Satellite systems approach followed by Japan and Europe.

The FCC has received nearly 20 proposals for terrestrial transmission standards, although only a handful of these appear likely to be developed. These proposals encompass such issues as: the degree of compatibility with existing **NTSC** receivers and the current channel bandwidth; the means of adding additional information needed to improve picture resolution, including the video encoding technique; methods of widening the picture; and the manner in which the picture is scanned—interlaced or progressive.¹³ **In general**, the proposals **can be** grouped in the following four categories: **NTSC** Receiver-Compatible **HDTV**; Channel-Compatible or Simulcast **HDTV**; Alternative Media **HDTV**; and Non-Compatible Recorded Media **HDTV**.

In September 1988, the FCC tentatively ruled that broadcasters must continue to transmit signals that can be received on today’s **TVs**; and that no additional radio spectrum would be allocated for **HDTV** broadcasting outside the existing spectrum

¹¹**NTSC** shows 59.94 fields per second in a 525 line interlaced scan, or equivalently, about 30 frames per second. **SECAM** (Sequential Color with Memory) and **PAL** (Phase Alternation by Line) show 50 fields or 25 frames per second at 625 lines per frame.

¹²**W.F. Schreiber**, “A Friendly Family of Transmission Standards for All Media and All Frame Rates” (Cambridge, MA: Massachusetts Institute of Technology, Feb. 12, 1989), draft.

¹³See, for example: “FCC Advisory Committee on Advanced Television Service: Systems Subcommittee, Interim Report,” Apr. 10, 1989.

allocations for TV.¹⁴ Together, these effectively rule out noncompatible HDTVs such as the original Japanese MUSE system, but would allow either the receiver-compatible or simulcasting approaches for terrestrial broadcasting (box 4-3).¹⁵

Today's TV audience views a picture far worse than what is theoretically possible, and might easily mistake a studio quality NTSC picture for HDTV. NTSC is susceptible to a variety of transmission problems—ghosts, snow (noise), interference from other stations, etc. (box 4-1). Further, NTSC does not use the available spectrum efficiently: more information could be packed into the existing bandwidth; and large amounts of spectrum are unusable—every other channel in VHF and typically five out of six channels in UHF are not used because of interference problems. To the extent that EDTV and HDTV require compatibility with the existing NTSC system, they could lock in these technical flaws for many years in the future. Better antennas and modem electronics can reduce some of these problems. Development of a new system, however, might achieve far more.

NTSC Receiver-Compatible HDTV

The transition from B&W TV to Color TV was done by altering the NTSC signal to include color while degrading the performance of B&W sets receiving color broadcasts only slightly—thus **maintaining** compatibility. This is also the most frequent proposal for making the transition to HDTV. The inefficiency of the current NTSC signal, however, means that only modest improvements can be achieved in the picture while staying within the current 6-MHz channel bandwidth. (The 6-MHz, NTSC-compatible HDTV proposals are here termed EDTV.)

HDTV quality and **full** receiver-compatibility require additional spectrum. The full 6-MHz channel (with some **modifications**) plus an additional one-half or full channel (3- or 6-MHz) someplace else in the spectrum must be used to augment the signal and to provide the additional detail needed for a high-quality picture. Standards proposals of this type include those from: **Faroudja Labs** (U. S.), Japan Broadcasting Corporation (**NHK**), **MIT** (U.S.), North

Box 4-3—Levels of Receiver Compatibility

- o. The current receiver is unable to display, in any form, HDTV transmissions; the HDTV receiver is **unable** to display NTSC transmissions.
1. An adapter box can be purchased separately so that existing NTSC receivers can display HDTV transmissions at the NTSC level of quality; HDTV receivers can display either HDTV transmissions at high definition or NTSC transmissions at NTSC quality.
2. An NTSC system can display HDTV transmissions at somewhat reduced quality compared to conventional transmissions. This is what happened in the conversion from B&W to color broadcasts. HDTV receivers, as above.
3. An NTSC can display HDTV transmissions at the same quality as a normal NTSC transmission; HDTV receivers, as above.

American Philips (Netherlands), **Sarnoff Labs** for Thomson (France) and **NBC**.¹⁶

Channel-Compatible or Simulcast HDTV

An HDTV-quality picture could be broadcast within the current 6-MHz channel bandwidth, but only if the constraint of **NTSC-compatibility** is removed so that the bandwidth can be used more efficiently. In this case, a standard NTSC signal would be transmitted with no changes on one channel; an HDTV signal would be simulcast independently on another channel. With proper design of the signal, now unused “taboo channels” could likely provide the needed broadcast spectrum for such simulcasts. Over a long period of time, the conventional NTSC channels could be gradually phased out and replaced with the simulcast signal alone. The portion of the spectrum vacated could then be used for the next generation of television technologies or for other uses such as mobile communications.

Zenith and MIT are the principal proponents of such systems, with **NHK** (Japan) also recently offering a simulcast system and North American Philips announcing that they are developing one.

¹⁴Individual broadcasters could receive additional spectrum to augment their signal from within the current bands for TV broadcasting, however.

¹⁵Federal Communications Commission Record, FCC 88-288, 3 FCC Rcd No. 23, Sept. 1, 1988.

¹⁶Other initial proposals of this type but since withdrawn include the Broadcasting Technology Association of Japan, the Del Rey Group, and the New York Institute of Technology.

These latter proposals indicate the increasing attention and interest in the simulcast approach.

Alternative Media HDTV

These systems are designed for use with media other than **terrestrial** broadcasting. They are primarily oriented toward satellite broadcasts. **NHK** (Japan), North American Philips (Netherlands), and Scientific Atlanta are among the proponents of such systems.

Noncompatible Recorded Media

HD-VCRS or **HD-Video** disks in the noncompatible Japanese MUSE format might be introduced in the United States as early as 1991. These systems do not require FCC approval, but are a concern to broadcasters because they might accelerate the ongoing erosion of broadcasters market share. As a result, these media have been an important driving force behind the current FCC study of advanced television.

Receivers for HDTV

The various proposals for HDTV receivers respond to the current debate over transmission standards—specifi.cally, whether the transmission system will be receiver-or channel-compatible, and whether there will be one standard or many for the different media. Receivers now envisioned can be classified as “closed,” “**multiport**,” “open,” or “smart.”

Closed Receivers

Closed receivers are similar to those used today. They are possible only if a single standard is set industry-wide for all media. Such a system has no flexibility to allow future changes in broadcast standards or to allow later options to be added to the HDTV without substantial modifications to the receiver.¹⁷

Over the near-term, these systems might cost somewhat less than more flexible designs discussed below. The current rapid pace of technological change might, however, make closed systems quickly obsolete—increasing the costs to consumers over the longer term.

Multiport Receivers

Multiport receivers will have multiple jacks or inputs that could accept several incompatible signals: one for terrestrial broadcasts, a second for cable, a third for DBS, and so on. Such HDTVs would have less flexibility to adapt to **future** changes or to allow the addition of various options than those described below. The costs of **multiport** (and other) receivers may be increased if they must accommodate several radically different standards.

Open Architecture Receivers

These receivers would be designed to accept a variety of standard plug-in circuit boards. The sets could be **modified** over time (at a price) to accept a wide variety of signals and standards, yet properly display the picture. These systems **might** also be adapted to provide other services—such as home computing and telecommunications—just as today’s personal computers can have circuit boards added to increase their versatility and power. Open Architecture Receivers might also create new business opportunities for third-party vendors of equipment and services.

Opponents of the Open Architecture Receiver argue that this approach would increase costs and complexity for users. Proponents point out that the rapid changes in technology demand flexible open systems and that such systems may ultimately lower overall costs to users. Nor **are** such systems necessarily complex. A simple channel selector and volume control like today’s can be provided for those who want only to watch TV.

“Smart” Receivers

Smart receivers are the most technologically advanced receivers currently conceived. They would adjust to a wide variety of transmission standards by automatically decoding the transmission format. Such sets could even adjust to a format that varied according to the type of material **displayed**—scenery with little motion could be shown in very high resolution, whereas rapid action sports **would** emphasize the display of **motion**.¹⁸ Smart receivers would probably be more expensive for the near term

¹⁷The original NTSC standard has been upgraded overtime—with color, stereo, closed captioning, etc. However, the rapid changes in communications technologies and electronics capabilities suggest that much more dramatic changes may be possible in the near future.

¹⁸William F. Schreiber and Andrew B. Lippman, “Single-Channel HDTV Systems, Compatible and NonCompatible,” Massachusetts Institute Of Technology, Mar. 11, 1988.

due to the high cost of the electronics required for such advanced data manipulation.

HIGH-RESOLUTION SYSTEMS AND TECHNOLOGIES

The evolution of television technology towards digital electronics is converging with the evolution of computing towards multi-media presentations (including text, data, graphics, and full-motion video).¹⁹ The underlying storage, processing, transmission, and display technologies of high-resolution entertainment video and multi-media computing are becoming largely **indistinguishable**.²⁰

All of these technologies which emphasize **high-quality** imaging or displays can generically be termed High Resolution Systems (**HRSs**). **HRSs** encompass an enormous range of markets—ATVs generally and HDTV in particular; multi-media PCs; engineering workstations; scanning and imaging equipment for electronic document storage; digital photocopiers and facsimile machines; and many others.

The applications of **HRSs** are equally diverse. These could include: video entertainment (HDTV), interactive video systems, electronic imaging for

document **storage**²¹, desktop publishing, graphics for engineering workstations, **and** many others. Many foresee these markets merging. For example, an HDTV/PC might be able to receive or record an HDTV program, search a video database, or include a video clip **in** a report along with text and graphics. Such systems are potentially interactive, allowing the HDTV/PC viewer to request additional information of a news clip, or even to **mod@** the picture being watched.

HDTV plays a particularly important role in the development of High Resolution Systems. HDTVs must handle enormous information flows and so require immense processing power. These demands make HDTV a **significant** driver of certain technologies (**ch. 5**). The high demand for video entertainment may **aid** the penetration of these powerful systems into the residential market. This might allow the HDTV/PC of the future to become the home terminal—an ‘information appliance’ ‘-on a national fiber network. It is this vision of the information society of the future that is being promoted by MITI and MPT (**ch. 2**). Whether or not HDTV can fulfill such a role in the United States is a matter of public debate (**ch. 6**).

¹⁹“Moving Beyond VGA,” *Electronics*, July 1989.

²⁰There are, of course, differences in terms of the signal transmission formats, receiver processing, and the brightness and size of the display, etc.

²¹“Imaging,” *Electronics*, July 1989.

Linkages Between HDTV, HRS, and Other Industries

INTRODUCTION

HDTV is possible only through the intensive use of digital electronics; **significantly** higher quality pictures than today's NTSC cannot be delivered to the home by any other means because of bandwidth constraints. As a result, the core technologies of HDTV-production, storage, transmission, processing, and display of information-are the same as those used in computer and telecommunications devices.

It is often overlooked in the current debate that HDTV is a development vehicle for "High-Resolution Systems" (**HRS**) generic to all information systems. HDTV proponents, for example, argue that the ability to produce high-performance displays and other technologies gained from a presence in the HDTV market will give manufacturers significant advantages in producing related components and systems for the computer and telecommunications markets. Skeptics resist the linkage argument as an unproven hypothesis and insist that these technologies can be developed by the computer and telecommunications industries independently.

OTA found evidence that HDTV developments *are driving the* state-of-the-art in several of these technologies more rapidly than are developments in computer or telecommunication systems. The enormous amount of information in a real-time, full-color HDTV signal-some 1.2 billion bits per **second**¹ (1.2 **Gbps**) in the uncompressed signal-places severe demands on today's technologies. This contrasts sharply with the conventional stereotype of consumer electronics as low-technology products lagging far behind the leading edge of computers and telecommunications.

HDTVS must handle huge information flows and require special hardware to provide high computational speeds to convert a signal compressed for transmission back into a viewable picture. Digital Signal Processors (**DSP**) tailored to this specific task

are meeting that requirement. In contrast, engineering workstations, for example, must flexibly perform a broader range of calculations than an HDTV; therefore, they are software **programmable**.²

The major technological bottleneck for the workstation today is the computational speed and the flexibility of its microprocessor and graphics display chips. Workstations put less stress on communications, storage, and certain aspects of display technologies than HDTV because they do not yet approach the information flows or the (specialized) computational speeds demanded of HDTVS.

Other High-Resolution Systems (**HRS**), such as desktop publishing and medical imaging, place different and often lower demands on **DSP**, storage, and communications technologies than does HDTV. They typically do not operate in real-time **and** accordingly have lower rates of information flow. Many of these other applications also place lower demands on display technologies than does HDTV. They work well enough with slower response times, limited colors, lower brightness, or smaller display areas. Providing sharp images of stationary objects as is usually the case with computer applications is, in many respects, technologically easier than providing high-resolution, real-time, fill-motion video. These other **HRSs** often require, however, higher resolutions than currently planned for HDTV **displays**.³

While many of the linkages between these technologies are obvious, they are not easily measurable. Nevertheless, these linkages can have an enormous impact on widely scattered technologies and markets. Simple analyses in which the projected **future** value of an industry is discounted to the present cannot account for the new and unforeseen opportunities that might be created by being in a market. Sony's and Philips' development of the compact disk player, for example, has opened huge markets in computer data storage. Similarly, flat panel

¹This is for the NHK system. Other systems might have somewhat higher or lower data rates.

²Note that "smart" HDTVS would have the capability to be somewhat softwareprogrammable, but are not included here as they are not likely to be sufficiently low in cost for consumer use for some time. Their development will push the state-of-the-art significantly **iprogrammable DSP**.

³Because computer displays are normally viewed closeup and there are eye fatigue issues, some of the design criteria are different.

plasma and electroluminescent displays, among others,⁴ drove the initial development of Power Integrated Circuits (Power ICS) which, in turn, are revolutionizing the distribution and control of electric power in equipment ranging from aircraft to air-conditioners.

The linkage argument does have limitations. For example, unlike leading-edge PCs or workstations where performance is everything and price a secondary consideration, HDTVS must be produced and marketed at a price within reach of consumers. This demands exacting design and manufacturing discipline that is often lacking in narrower or more specialized markets, such as the military or medical imaging.

The large potential size of the HDTV market could enable significant improvements in manufacturing technology as firms seek to lower production costs. In some cases, low-cost manufacturing will require pushing the state-of-the-art in component technologies; in others, it will mean that HDTV will let the computer or telecom markets push the state-of-the-art and will then use those results. Above all, HDTV-as-for all consumer electronics—will require pushing the limits of cost-effective manufacturing of sophisticated electronic systems. This might be one of the most important impacts of HDTV.

Whether or not a consumer HDTV market develops, the expectation that there will be a large market is forcing manufacturers who wish to participate to push the state-of-the-art in the various HDTV-related technologies. If the market does develop, then large-volume production might give the producer economies of scale in a number of other components and products.

Having a technology matters little if markets are closed to innovators or the entry barriers are effectively insurmountable. As a result, it is also important for those that develop the technology to capture a significant share of the market. In the past, the United States has assumed that if the technology

was developed, markets would follow. Faced with large, usually vertically (and horizontally) integrated, aggressive foreign competitors; and confronted with increasingly skill- and capital-intensive R&D and manufacturing to produce high-technology goods, this assumption is no longer valid.

Neither linkages nor market share nor volume production of computers were sufficient to save the U.S. DRAM business. U.S. firms produce about 70 percent of the world's personal computers today and lead the world in PC design. Nevertheless, domestic firms have lost the market for DRAMs to Japanese firms. A combination of factors, including less efficient manufacturing by some U.S. firms on one hand and aggressive foreign trade practices on the other, forced most U.S. manufacturers out of this important market.

The United States has also lost important HRS imaging markets such as low-end copiers, as well as many other pieces of the electronics industry, despite having a predominant market share in many of these just a few years ago.

Startups in the U.S. electronics industry are increasingly focusing on design alone and depend on foreign operations for the highly capital-intensive manufacturing operations⁵—they cannot secure the capital necessary to do the manufacturing themselves. In contrast, a number of foreign firms with little expertise in advanced electronics are becoming important manufacturers of electronics through heavy and long-term investments and careful attention to the manufacturing process. For example, NMB Semiconductor, a new subsidiary of a Japanese ball-bearing company, Minebea, in just 5 years entered and became the world leader in very fast DRAMs.⁶ Kubota, a Japanese agricultural equipment company, is now manufacturing mini-supercomputers designed in the United States.⁷ Similarly, Korean semiconductor firms are now becoming important producers of commodity DRAMs.

The United States cannot survive by performing R&D alone. Manufacturing provides far more jobs,

⁴Others include non-impact printers and multiplexing automobile wiring. In particular, automotive applications are expected to become an increasingly important driver of this technology in the next few years. Martin Gold, "Autos Drive Smart Power C&D," *Electronic Engineering Times*, Jan. 15, 1990, p. 39.

⁵Integrated Circuit Engineering Corp., "Mid-Term 1988," Scottsdale, AZ, lists 18 startups during 1984-87 that chose not to build their own fabrication facilities. Of these, at least one-third were using fabrication facilities in Japan, Taiwan, and Korea.

⁶"How NMB Took Over the Fast DRAM Market," *Electronics*, November 1988, p. 188; Bob Johnstone, "Chips and Sushi," *Far Eastern Economic Review*, July 20, 1989, p. 52.

⁷David E. Sanger, "U.S. Parts, Japanese Computer," *New York Times*, Sept. 7, 1988, p. D1.

greater value-added, and larger cash flows than R&D, and these are needed if future investments are to be made in R&D or production. Nor can we expect every American to earn a living **as** a design engineer. With the increasingly tight linkages between R&D and manufacturing due to the exacting requirements of modern manufacturing processes and quality control, and due to **the** need to design for manufacturability, R&D is merging with the manufacturing process. In many cases, when the United States loses manufacturing, the loss of R&D is not far behind.

The problems facing the U.S. electronics industry are much broader than simply HDTV. Although HDTV maybe an important element of any broader U.S. strategy in electronics, by itself HDTV will neither seal the fate nor save the U.S. electronics industry. There are undeniable linkages—some strong, some weak—that should be recognized, but the problems facing the U. S. industry extend into many other financial and structural factors. These include: the higher cost of capital in the United States resulting, in part, in lower capital and R&D investments than our competitors; inattention to manufacturing process and quality, poor design for manufacturability, and separation of R&D **from** manufacturing; foreign dumping and foreign market protection; and smallness of scale and/or lack of vertical/horizontal integration compared to foreign competitors. Some of these broader issues facing U.S. manufacturing are discussed in a recent **OTA** report “Making Things Better.”

SEMICONDUCTORS

The rapid technological advances and cost reductions of digital electronics will likely make HDTV affordable in the not-too-distant future. During the past 10 years, the capacity of leading-edge memory chips (DRAMs) has increased by 250 times while the cost per unit memory has decreased nearly 100 **times**.⁹ Each generation of advanced TVs will use increasingly complex digital semiconductors to provide a better quality picture at a lower cost.

In turn, HDTV will directly push the **state-of-the-art** in various aspects of digital signal processor (DSP), display, data storage, and possibly **semicon-**

ductorpackaging technologies, among others. HDTV may indirectly impact a much broader range of components as well as computer and telecommunication systems as a result of these technological advancements.

Digital Signal Processing

There are **three** steps in digital signal processing. First, the continuously varying analog signals of the real world—sound, light, temperature, etc.—are converted into a digital form usable by computers with an analog to digital (A/D) converter. (See box 4-2.) Second, the signal is processed with a Digital Signal Processor—to decode the tightly compressed broadcast signal back into a recognizable picture, or reduce ghosts and snow (noise) to produce a near-flawless picture. Third, the digital signal is converted back into an analog form—sound and pictures, etc. that people can understand—with a digital to analog (D/A) converter.

A digital signal can be manipulated (as in signal compression), analyzed, transmitted with greater reliability, and stored in computer memory. In general, the more the broadcast signal is compressed to fit into a narrow bandwidth, the more digital signal processing power is required for its **reconstruction**.¹⁰

Digital signal processing is used today in compact disk players, facsimile mail, long-distance telephone lines, computer modems, and in other applications. Human hearing and vision are analog, so digital signal processing will play an increasingly important role in providing an ‘interface’ between people and information systems in **the** future as we come to rely more on images and sound instead of alphanumeric text.

Digital signal processing chips (A/D, **DSP**, D/A) and digital signal processors in particular for HDTVs are at the leading edge of many aspects of the technology (figure 5-1). For example, at the 1989 International Solid-State Circuits Conference (the most important international conference for unveiling new chip technologies), some of the fastest **DSP** chips ever developed were specifically designed for

⁸U.S. Congress, Office of Technology Assessment, *Making Things Better: Competing in Manufacturing*, OTA-ITE-443 (Washington, DC: U.S. Government Printing Office, February 1990).

⁹Integrated Circuit Engineering Corp., op. cit., footnote 5.

¹⁰The development of better video signal compression algorithms is an important non-hardware aspect of current work in HDTV that is also critical to the success of interactive video systems.

Figure 5-1-Selected Applications of Digital Signal Processors v. the Speed of Operation

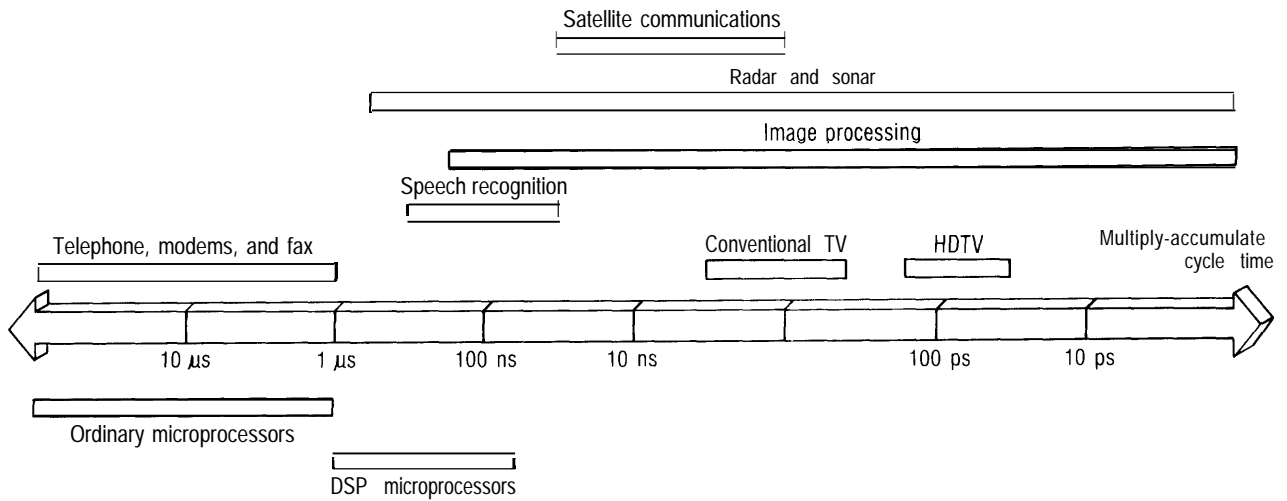

HDTV is among the most demanding of applications in terms of speed

SOURCE: Jack Shandle, "Signal Processors Open Up New Territory in Communications," *Electronics*, April 1989, p. 79. Used with permission.

HDTV or related color video signal processing.¹¹ The only comparably demanding applications today, at least in terms of speed and throughput, are military radar and sonar (highly specialized and low-volume markets), and image processing that is closely related to HDTV.

An uncompressed HDTV signal contains about 1.2 billion bits per second (1.2 Gbps) of information. In comparison, today's advanced engineering workstation hits peak speeds internally of roughly one-half gigabit per second.¹² This signal is compressed, transmitted, and is then converted back into a viewable picture by the receiver. The amount of computation needed to decode this varies with the standard chosen, but can be as much as 2 to 3 billion mathematical operations per second. DSPs are able to handle these huge information flows and computational speeds—roughly comparable to those attained by today's supercomputers—at a cost consumers can pay only through specialized designs tailored for specific tasks. Unlike HDTVs, supercomputers are able to handle a broad range of computations and to do so much more flexibly.¹³

The development of certain important computer technologies may be aided in part through efforts in developing digital signal processing for HDTV. For example, the "testbeds" built by the Japanese to develop DSPs have required extensive work with massively parallel processor systems—the ability to hook-up many microprocessors in parallel to speed up computations. At Nippon Telephone & Telegraph, for example, the National Academy of Sciences Panel reviewing Japanese HDTV development efforts observed a system with 1024 processors in parallel, far fewer than some U.S. systems but still a notable achievement. Parallel processing has been a significant weakness in Japanese supercomputer technology, and a primary area in which U.S. firms have managed to maintain their edge. The experience with parallel processing hardware that the Japanese have gained in their HDTV development efforts may have spinoffs to their supercomputer systems.

Similarly, HDTV research at the David Sarnoff Research Center has led to the development of a video-supercomputer capable of an information flow rate of 1.4 Gbps and computational speeds of

¹¹Richard Doherty, "At ISSCC, Parallel Signal Processing," *Electronic Engineering Times*, Feb. 27, 1989.

¹²Richard McCormack, "Supercomputer Highway Could Be a Country Road," *Say Industry Executive*, "New Technology Week," Aug. 14, 1989.

¹³David Messerschmitt, Department of Electrical Engineering, University of California—Berkeley, personal communication, July 31, Oct. 12 and 13, 1989.

¹⁴Ibid.

some 1.4 trillion mathematical operations per second at a cost of less than one-tenth that of other supercomputers.¹⁵

The DSP market is growing rapidly. It is expected to increase from about \$650 million per year to \$1.6 billion by 1992 (figure 5-2). If the HDTV market develops, HDTVs will use an enormous amount of digital signal processing. For example, the Japanese MUSE-9 system uses some 500,000 gates—a measure of processing power—to convert the highly compressed signal back to a picture.¹⁶ DSP requirements may be less or more than this, however, depending on the eventual choice of transmission and receiver standards.

If high rates of growth are realized for the HDTV market in the United States, Japan, and Europe,¹⁷ then 15 years from now the use of digital signal processing chips in HDTVs alone could be 10 times today's total world demand (measured by processing capacity—'gates') for all microprocessor and related applications and roughly 100 times today's demand for DSP.¹⁸ Such estimates are speculative; their qualifications are discussed below. Depending on the relative growth of the computer, telecommunications, and other markets, this may or may not be important compared to the entire microprocessor and microcontroller market in 15 years. It would, however, almost certainly have a strong impact on the cost of DSPs for video processing. Even under low-growth scenarios a tenth as large, HDTV would likely have a strong impact on the cost of DSPs for video processing.

The United States currently has a stronger position in DSP design than Japan and is about equal to Japan in the production and performance of DSP chips. Domestic firms have managed to maintain a dominant market position in DSP because they have better software for developing these chips. Texas Instruments currently has 60 percent of the world DSP market; NEC is second with 11 percent.¹⁹ Production of DSPs for HDTV could significantly

Figure 5-2—Projected Growth of the Digital Signal Processor Market, 1989-92

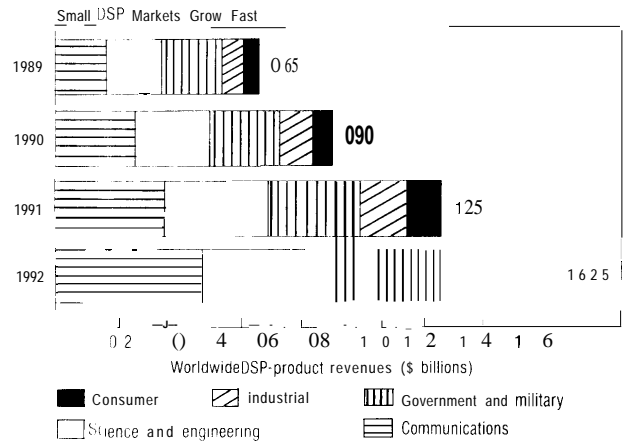

SOURCE: Jonah McLeod, "DSP," *Electronics*, April 1989, p. 71.

change these market positions, depending on a firm's presence in HDTV. Such concerns may have been a factor in Texas Instruments' recent decision to purchase the Japanese HDTV chip designs and technology from Japan's NHK in order to participate in the Japanese HDTV market.²⁰

DRAMs

HDTVs similarly place heavy requirements on memory technology. Access times needed for HDTV memory chips must be roughly 20 nanoseconds (ns)—20 billionths of a second. Today's fastest DRAMs have typical access times of 60 to 80 ns.

Leading-edge PCs and workstations are providing a significant market pull for the special techniques and faster types of memory devices such as SRAMs (Static Random Access Memory) necessary to operate at high speeds. If the HDTV market develops, it could provide an additional pull for leading-edge fast DRAMs. Matsushita's 8 Mb Video RAM, for example, has a serial access time of 20 ns, 1.5 times faster than current VRAM technology.

¹⁵David Sarnoff Research Center, "The Princeton Engine: A Video-Supercomputer," Sarnoff Labs, Sept. 28, 1989.

¹⁶David Lammers, "U.S. ASICs on TV," *Electronic Engineering Times*, Feb. 27, 1989.

¹⁷Corresponding market projections are those by the Electronic Industries Association (EIA) for the United States and the Japanese Ministry of Posts and Telecommunications (MOPT). Similar sales rates were assumed for Europe with appropriate reductions for the observed lower rates of household penetration for color TVs.

¹⁸Worldlogic Gate production in 1987 is estimated by OTA to be about 2 trillion gates for microprocessors, microcontrollers, and ASICs. The comparison is made by multiplying the high growth projections for HDTV by 500,000 gates per set.

¹⁹William I. Strauss, "Fe@-Genemtio, DSPs Will Debut Next Year," *Electronic Engineering Times*, Aug. 7, 1989, p. 55.

²⁰Jacob Schlesinger, "Texas Instruments Agrees To Buy HDTV Technology From Japan," *Wall Street Journal*, Sept. 14, 1989.

HDTV could also become a **significant** new market for DRAMs. An HDTV might use as much as 32 million bits (Mb), equivalent to 4 million bytes (MB) of DRAM, to store the HDTV picture in memory.²¹ Assuming rapid growth of the HDTV market as above, then the use of DRAMs in HDTVs alone in 15 years could be five times the total 1987 world demand (by memory capacity-bits) for **all DRAM applications**.²² Depending on the relative growth of the computer, telecommunications, and other markets, this may or may not represent a significant **fraction** of world DRAM use at that time. Japanese firms are, however, already establishing major new DRAM production facilities with the expectation that their output **will** be used in Advanced TVs.²³

These scenarios for DRAMs and DSPs are subject to a number of **qualifications** and uncertainties. If the standard chosen for HDTV uses significantly less memory and digital signal processing, then the projections would be adjusted accordingly. If the development of the **IDTV** market, for example, substitutes for HDTV and prevents HDTV market growth, then the DRAM projections would be reduced by a factor of 4 because the typical **IDTV** is expected to use about a quarter of the memory used in an HDTV. If consumers instead move progressively upscale, buying **IDTVs** and **EDTVs** first and then move to HDTV, relegating their **IDTVs/EDTVs** to use as a second set as they did B&W sets when moving to color, then chip demands could be 25 to 50 percent greater than projected. If strong commercial markets for HDTV develop, as predicted by the Japanese MPT, then chip demand could be twice the projections above. Factoring in production and broadcasting equipment sales could increase these projections by 10 to 15 **percent**.²⁵ Finally, some believe that progressively more sophisticated systems will be developed beyond HDTV, requiring even more memory and signal processing.

Fifteen years ago the United States had more than 90 percent of the world market in DRAMs; today the United States makes less than 15 percent of the DRAMs purchased in world (merchant) markets. Texas Instruments, Micron Technologies, Motorola with technology licensed **from** Toshiba, and IBM (for internal consumption) are the only U.S. firms still producing DRAMs. The recent effort to form a consortium, U.S. Memories, might have improved somewhat the U.S. position. For a variety of reasons, however, it failed to attract sufficient support **from** U.S. firms to even be launched.

Gallium Arsenide and Other Compound Semiconductors

Receiver-compatible HDTV systems propose use of the standard 6 MHz **NTSC** signal, which would then be augmented with a second signal 3 to 6 MHz wide to provide the additional information for the higher quality picture. The wider bandwidth of such HDTV systems may require **GaAs** (Gallium Arsenide) chips in the tuner due to their wider bandwidth capability and their ability to handle **overloads**.²⁶

GaAs and related materials are now used in a variety of applications, ranging **from** some **leading-edge** supercomputers to the lasers in CD-players and in fiber-optic systems. The use of **GaAs** remains limited, however, due to **the** difficulty of producing high-quality stock material and fabricating semiconductor devices from it. If HDTV provides a large market for **GaAs** devices, the additional production volume might help some of these difficulties to be overcome. Improved **GaAs** materials production and fabrication techniques could have spinoffs to a variety of markets.

The United States seriously lags Japan in a variety of **GaAs** and related materials, processing, and

²¹Some researchers believe that fairly high resolutions can be achieved without such large use of memory; others insist that there are significant advantages in having a full frame memory, or 20 to 32 Mbits, depending on the standard, etc. Ultimately, the memory and digital signal processor demands will depend strongly on the particular standard chosen, but will also likely increase over time. (A Byte equals 8 bits and can represent one character on a keyboard.)

²²Estimated 1987 world DRAM production is 2.3×10^{11} bits. Integrated Circuit Engineering Corp., op. cit., footnote 5.

²³*Nihon Kogyo Shimbun*, July 6, 1989, cited by Barry Whalen and Mark Eaton, "Prospects for Development of a U.S. HDTV Industry," Committee on Governmental Affairs, U.S. Senate, Hearing 101-226, Aug. 1, 1989, p. 516.

²⁴Charles L. Cohen, "NEC Takes An Early Lead in Improved-Definition TV," *Electronics*, Dec. 17, 1987.

²⁵William Glenn, Florida Atlantic University, Boca Raton, personal communication, Feb. 10, 1989.

²⁶Al Kelsh, National Semiconductor, personal communication, Mar. 21, 1989; Birney Dayton, NVision, personal communication, Mar. 8, @ t. 12 and 13, 1989; Ronald Rosenzweig, Testimony at hearings before the House Committee on Science, Space and Technology, Mar. 22, 1989.

device **technologies**.²⁷ Despite pioneering the development of many of these semiconductor devices, the United States today buys much of the unprocessed GaAs material **from** Japan as well as the semiconductor devices fabricated from it. AT&T invented the solid-state laser, but in some cases has purchased semiconductor lasers from Japan to drive its fiber cable.

Semiconductor Manufacturing

Highly disciplined and cost-effective **manufacturing** is required for a large HDTV market to develop and for a firm to successfully compete within it. Technology will have to squeeze even more circuitry onto the same sliver of silicon to bring the cost of HDTVS to reasonable levels. Reductions of the total number of chips in this manner reduces costs-of-components, of assembling and testing the HDTV, of repairing defects, and by increasing reliability. Reducing the number of parts in color TVs was an important aspect of the competition between the U.S. and **Japanese** producers in the 1970s—and an aspect in which U.S. producers seriously lagged. The quest to reduce the number of chips in systems is responsible for the explosion in **ASIC** (Application **Specific** Integrated Circuits) production, which now accounts for about a quarter of **all** merchant integrated circuit Production.²⁸

Efforts to reduce the number of chips needed can already be widely seen in ATV development. **NEC**, for example, reduced the number of chips in its IDTV **from** 1,800 to 30.²⁹ An early prototype of the Japanese MUSE HDTV system had 40 printed circuit boards, each **containing** 200 chips for a total of 8,000 chips. In contrast, the latest generation of MUSE decoders unveiled in June 1989 has less than 100 chips. Half of these were **ASICs** with 26

different designs. To **minimize** the burden on any one manufacturer in developing these numerous and complex **ASIC** designs, **NHK** divided the effort among 6 different manufacturers, and then distributed the designs among all the participants (**ch. 2**).

Manufacturers are also pushing the design of conventional memory chips. Matsushita recently unveiled an 8 Mb Video RAM designed **specifically** for application in HDTV, and intends to begin commercial sampling in 1990.³⁰

Eventually, nearly all of the required memory and DSP for an HDTV might be combined on a **single** chip. Increasing levels of chip integration will require a significant increase in current capabilities, and correspond to the expected leading edge of semiconductor technology for the next **decade**.³¹ The extent to which this drives the state-of-the-art will depend on the relative size of the HDTV, computer, telecommunications, **and** other markets.

A number of important studies have documented the current U.S. lag behind Japan in a broad range of semiconductor process technologies:

- The Federal Interagency **Task** Force found the United States lagging Japan in 14 semiconductor process and product areas; the United States was ahead in just six categories and its lead was found to be slipping in five of these (figure 1-1).³²
- The National Academy of Sciences found the Japanese leading in 8 of 11 semiconductor process technologies that will be critical in the **future**.³³
- A recent study by the Department of Commerce found Japanese semiconductor plants had a 5-year lead over the United States in the use of computer integrated manufacturing **techniques**.³⁴

²⁷Report of the Federal Interagency Staff working Group, "The Semiconductor Industry," National Science Foundation, Washington DC, Nov. 16, 1987.

²⁸Merchant producers are those which sell on the open market and include all Japanese and most U.S. semiconductor producers. Captive producers are those which use the semiconductors they produce themselves and do not sell them outside the firm. The world's top three ASIC producers are Fujitsu, Toshiba, and NEC.

²⁹Cohen, *op. cit.*, footnote 24.

³⁰Miyoko Sakurai, "8 Mbit VRAM for HDTV," *Electronic Engineering Times*, Apr. 3, 1989.

³¹Dayton, *op. cit.*, footnote 26; and* on projections by Craig R. Barrett, "Technology Directions for Integrated Circuits," Seminar at O'IA, June 15, 1989.

³²Report of a Federal Interagency Staff Working Group, *Op. cit.*, footnote 27.

³³National Research Council, "Advanced Processing of Electronic Materials in the United States and Japan," National Academy Press, 1986.

³⁴W.C. Holton, J. Dussault, D.A. Hodges, C.L. Liu, J.D. Plummer, D.E. Thomas, and B.F. Wu, "Computer Integrated Manufacturing (CIM) and Computer Assisted Design (CAD) for the Semiconductor Industry in Japan," JTECH Panel Report, Department of Commerce, Science Applications International Corp., December 1988.

These techniques have allowed the Japanese to reduce turnaround time by 42 percent, increase unit output by 50 percent, increase equipment uptime by 32 percent, and reduce direct labor requirements by 25 percent.

The Japanese have also rapidly improved their plant and equipment to take advantage of the more technically demanding, but cost-saving, large wafer technology. From a position of parity in 1984, they now use, on average, wafers that are nearly 35 percent larger in area than their American competitors.³⁵ IBM, however, is pioneering very large, 8-inch, wafer technology.

DISPLAY TECHNOLOGY

HDTV drives display technology perhaps more than any other single area. To truly appreciate HDTV, much larger high-resolution displays are needed than are generally available today. Indeed, some analysts believe that the HDTV market will not take off until large displays—40-inch diagonal and preferably larger—are available at reasonable cost. A HDTV display must have fairly high resolution—1000 lines or more; superb color; rapid response times; large size; good brightness, contrast, and efficiency; and low cost.

Numerous display technologies are being developed, including: improvements in conventional picture tubes; advanced projection displays using either CRTs, LCDs, or deformable membranes³⁶; and large-area flat panel liquid crystal displays, among others.

Conventional picture tubes will undoubtedly continue to be the display of choice over the next few years. They perform well, they are efficient, and they are low in cost due to the many years of experience manufacturing them. In the longer term, however, there will be a shift away from direct view picture

tubes. In the larger sizes desired for HDTV, direct-view CRTs are bulky and heavy in addition to being fragile. Although work is being done to reduce their depth³⁷, CRTs currently are nearly as deep as they are wide—few houses have either doors wide enough to accommodate large CRT displays (40-inch or more) or living rooms large enough to conveniently house them. Furthermore, the weight of a 40-inch CRT display is several hundred pounds.

By the mid-1990s, many analysts expect that high-performance projection systems will be available that provide the larger viewing areas needed for HDTV. Toshiba, NHK, Hitachi, Sanyo, Mitsubishi, and Philips have all developed projection systems for HDTV with screen sizes as large as 50 feet diagonal.³⁸ LCD and deformable membrane projection systems are also under development with some indications that the deformable membrane may have advantages in efficiency, brightness, contrast, and response time.

By the late 1990s, yet another display technology may become available—the active matrix flat panel liquid crystal display, or AM/LCD. Nine Japanese companies demonstrated 10- to 14-inch color LCD displays with resolutions of 640 by 400 pixels at the 1989 Tokyo Business Show.³⁹ IBM recently unveiled an experimental high-resolution 14-inch diagonal color liquid crystal display that it co-developed with Toshiba.⁴⁰ Figure 5-3 illustrates the current progress in developing AM/LCD displays and a few of the firms that have led the way.⁴¹ The Japanese recently began a 7-year, \$100 million collaborative research program to develop very large, 40-inch diagonal, color flat panel AM/LCD displays for HDTV and other applications (ch. 2).

Other display technologies are being investigated, but barring fundamental breakthroughs,⁴² they are less likely to be applied to HDTV. (In contrast, for

³⁵OTA estimate.

³⁶CRTs are cathode-ray tubes, the basic technology used today for TV picture tubes. LCDs are liquid crystal displays, the basic technology used today in pocket watches, calculators, and many of the laptop PC displays. Deformable membranes work by reflecting light off a membrane that is deformed point by point to either focus or diffuse the light so as to generate a picture.

³⁷David tires, "Matsushita Flattens CRT," *Electronic Engineering Times*, May 29, 1989, p. 29.

³⁸Lawrence E. Tannas, "T-View HDTV Displays: Evolving in Japan," JTECH Panel Review of HDTV—Japan—Present—tion at National Academy of Sciences, July 26, 1989.

³⁹*Electronics*, September 1989, p. 100; Special Advertising Section on Japan.

⁴⁰Ashok Bin @ "Flat Panel Advances Lead SID," *Electronic Engineering Times*, Apr. 24, 1989, p. 35.

⁴¹William C. Schneider, Griffith L. Resor, "High-Volume Production of Large Full-Color Liquid-Crystal Displays," *Information Display*, February 1989, p. 8.

⁴²For example, if a good blue phosphor can be found for electroluminescent displays, they might become a strong competitor with LCDs.

Figure 5-3--'Resor's Rule' for Active Matrix Liquid Crystal Displays (AM/LCDs)

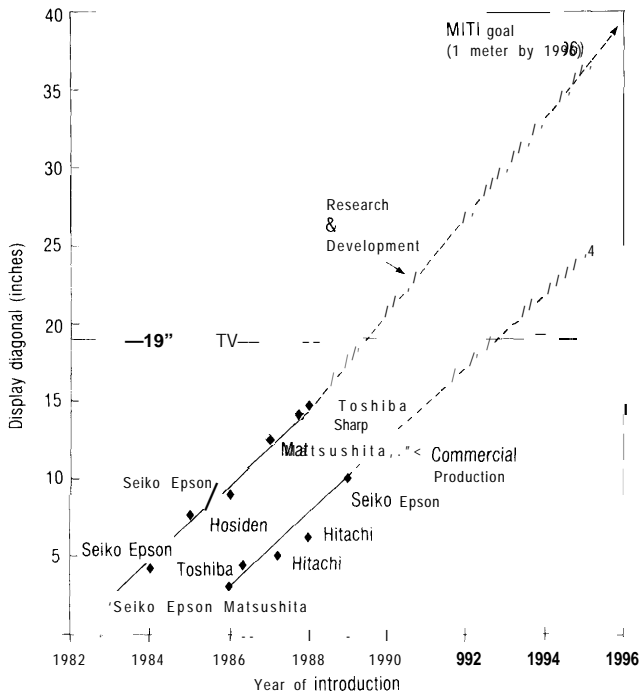

This shows the trend in display size by year for displays under R&D and in commercial production. Display size, as measured by the diagonal inch, is increasing at the rate of 3 inches (75mm) per year. Commercial introduction follows R&D production by approximately 3 years.

SOURCE: MRS Technology, Inc., Chelmsford, MA. Used with permission.

flat panel LCD displays the technical limitations are now believed to largely be in engineering.) Among these displays are light-emitting diodes⁴³, Plasma Display Panels^w, thin-film electroluminescent displays⁴⁵, and fiber-optic expanders⁴⁶, among others.⁴⁷ Size and weight, cost, brightness, power consumption, viewing angle, response time, and manufactur-

ing cost are critical factors for each of these display technologies. Progress in these technologies, however, is being made: the Japanese NHK Laboratory recently announced an experimental 20-inch diagonal plasma display⁴⁸, and some believe that new technologies might give plasma displays an edge over AM/LCDs.⁴⁹

Production of large flat-panel displays will require significant advances in a number of important technologies. These include: high-throughput low-cost lithography tools for large area, high-performance patterning of circuitry onto the panel; large-area, high precision glass sheet production; and large-area, high precision thin-film technology.

Such capabilities may have applications in many other areas as well. High precision control of thin films, for example, is generic to a variety of industries, from semiconductors to the production of optical disks. Large-area lithography is expected to be used to develop very high-density printed circuit boards, or "chips on glass" by the Japanese Key Technology Center AM/LCD research consortium. This could be a very important development and is discussed below.

Linkages such as these are difficult to anticipate. Simple accounting may overlook them, but they can sometimes lead to enormous new markets. Consider the example of the Power Integrated Circuit. The Power IC was initially developed and its costs were driven down, in part, by the demands of such devices as plasma and electroluminescent displays, among others,⁵⁰ for IC drivers capable of handling medium-level voltages (100 volts instead of the typically 5 or so volts used in computer circuits) and relatively high currents.

⁴³LEDs have generally low efficiency in emitting light, and there is an enormous variation in output and efficiency between different colors, making them hard to match. LEDs also have a fairly variable light output from device to device. There is relatively little new research going on now in LEDs.

⁴⁴Plasma Display Panels ionize a gas with a medium-level voltage (i.e., 100 volts) causing the gas to glow. Disadvantages include the cost of the electronics to deliver this voltage, low efficiency, and a limited color range.

⁴⁵Electroluminescent Displays work by applying a medium voltage across a material causing it to glow. Limitations are its low efficiency and limited color range. Planar (U.S.), in particular, has been working on developing a better "blue" color as well as better manufacturing processes and electronics that can vary the intensity of the colors. Tom Manuel, "A Full-Color EL Display Is Demonstrated by Planar," *Electronics*, May 26, 1988, p. 73.

⁴⁶Fiber-optic expanders have considerable promise, but are currently embroiled in a patent dispute. See George Gilder, "Severed Heads and Wasted Resources," *Forbes*, June 26, 1989.

⁴⁷Others include vacuum fluorescent displays, in which Futaba, NEC, and Ise hold the #1, 2, 3 market positions; cold cathode emitter displays; and electrophoretic displays.

⁴⁸Ashok Bindra, "Flat panel Advances Lead SID," *Electronic Engineering Times*, Apr. 24, 1989, p. 35.

⁴⁹David Lieberman, "Plasma's HDTV Focus," *Electronic Engineering Times*, June 12, 1989.

⁵⁰Others include nonimpact printers and multiplexing automobile* g, etc. Although applications in automobiles only began to be realized much more recently, they were a long-term goal for some manufacturers.

Plasma and **electroluminescent** displays are a tiny fraction of the display market and Power ICs for these panels are a still smaller market. Despite such humble beginnings, Power ICs are now **beginning** to **find** applications across a host of industries with important benefits. These range **from** potentially **significant** reductions in the weight and cost of aircraft wiring and **controls**⁵¹ to large improvements in the efficiency of refrigerators, room **air-conditioners**, and a host of other appliances.⁵²

With the expected transition to flat panels and other advanced display technologies, the United States has a fleeting opportunity to regain a strong market position in display technologies. In recent years the United States strength in display technologies and markets has slipped away to the Japanese. The United States still has a few scattered experts in basic CRT technology at Zenith, Tektronix, GE, Raytheon, Corning and a few other firms, but it lacks the broad-based talent of the Japanese, particularly in manufacturing.

U.S. **firms** are still competitive in some aspects of flat-panel display technologies: in design, in the production of the basic materials, in some of the manufacturing equipment, and in some **state-of-the-art** displays. Coming makes the best glass substrate in the world for AM/LCD displays and currently holds 90 percent of the Japanese market.⁵³ **MRS Technologies**, a Massachusetts venture startup, currently makes the world's best lithography tools for producing large flat panel displays.⁵⁴ U.S. **firms** also held half the 1988 world market in **electroluminescent** displays compared to Japan's 29 percent; and a quarter of the 1988 world market for plasma displays—down from 57 percent in 1984—compared to Japan's 68 percent.⁵⁵

These strengths are unlikely to last. In AM/LCD displays, there are five significant R&D groups in

the United States—**Sarnoff Labs**, **Ovonic**, **Magnascreen**, **Xerox**, and **Philips Labs (Briarcliff)**.⁵⁶ GE recently dropped its research program in **LCDs**. There are more than a dozen firms in Japan doing R&D in AM/LCD displays, most of them with more projects and people involved than any of the U.S. teams.⁵⁷ Tables 5-1 and 5-2 illustrate the disparity between U.S. and Japanese efforts in developing and producing flat-panel displays.

No AM/LCD production lines are now operating in the United States; essentially all of the world's production comes from Japan—which holds roughly 96 percent of the world market for (small pixel) passive matrix **LCDs** and virtually 100 percent of the market for active matrix **LCDs**.⁵⁸ Even if the United States were to make breakthroughs, the manufacturing infrastructure to produce the displays would not be in place. Without production, there will likely be little revenue to continue a long high-level research program—particularly considering the large capital investment and engineering effort required for producing very large area screens.

Already, the **remaining** U.S. strengths are being challenged. For example, a **MITI-sponsored** consortium, the New Glass Forum, was begun in 1985 to do R&D in glasses, some of which may have applications to AM/LCDs. **Nikon** (Japan) recently announced a lithography system with a higher throughput than that of **MRS Technologies**.⁵⁹

The market for displays for all purposes is large. Worldwide sales of flat panel displays of all types was \$2.4 billion in 1988, out of a total display market of \$8.2 billion. The flat panel market is expected to approach \$6.3 billion by 1995, out of a total display market of \$14 **billion**.⁶⁰ Other estimates place the

⁵¹Vladimir Rumennik, "power Devices Are In The Chips," *ZEEE Spectrum*, July 1985.

⁵²Samuel F. Baldwin, "Energy-Efficient Electric Motor Drive Systems," in *Electricity: Efficient End-Use and New Generation Technologies, and Their Planning Implications*, Thomas B. Johansson, Birgit Bodlund, and Robert H. Williams (eds.) (Lund, Sweden: Lund University Press, 1989).

⁵³Gary Stix, "n-ac-g Hurdles Challenge Large-LCD Developers," *IEEE Spectrum*, September 1989, p. 40.

⁵⁴Note, however, that it has lower throughput than the recent Nikon offering. See Stix, op. cit., footnote 53.

⁵⁵Heidi Hoffman, U.S. Department of Commerce, personal communication, Nov. 29, 1989.

⁵⁶Griffith Resor, MRS Technologies, personal communication, Oct. 12, 1989.

⁵⁷Lawrence Tannas, Tannas Electronics, personal communication, Aug 9, 1989.

⁵⁸Bob Whiskin, BIS Mackintosh, London, personal communication, Mar. 29, 1989.

⁵⁹Stix, op. cit., footnote 53.

⁶⁰U.S. Brains for a Desperate Fight in Flat Panels," *Electronics*, December 1988.

Table 5-1—Status of U.S. Producers of Flat Panel Displays in the 1980s

Company	EL	LCD	PDP	Other
Alphasil		Closed 1988		
AT&T			Closed 1987	
Cherry	Production			
Coloray				Seeking funding
Control Data			Closed 1980	
Crystal Vision		Closed 1984		
Electro-Plasma			Production	
EPID/Exxon				Closed 1986
Kylex/Exxon		Sold 1983		
GE		Sold 1989		
GTE	Closed 1987			
IBM			Sold 1987	
LC Systems		Closed 1988		
Magnascreen		Research		
NCR			Closed 1984	
Ovonic		Research		
Panelvision		Sold 1986		
Photonics			Production	
Planar	Production			
Plasma Graphics			Closed 1985	
Plasmaco			Research/Prod.	
Sarnoff Labs		Research		
Sigmatron Nova	Closed 1988			
Ti			Closed 1983	
Xerox		Research		

SOURCE: Dave Mentley, Stanford Resources, Inc., San Jose, CA, personal communication, Apr. 25, 1990; Jim Hurd, Planar Systems, Inc. Portland, OR, personal communication, May 1, 1990; Larry Weber, Plasmaco, Highland, NY, personal communication, May 1, 1990; and Defense Science Board, "High Definition Systems Task Force, Final Report," Washington, DC, forthcoming.

Table 5-2—Recent Investments in AM/LCD Production Facilities in Japan

Company	Investment (U.S. \$million) ^a	Operational	Factory location	Technology
Alps	\$33	1992	Iwaki	TFT
Fuji-Xerox	80	ND	Ebina	a-Si TFT
Hitachi	134+67/yr	ND	Mobara	a-Si TFT
Matsushita	230	4Q1991	Osaka	Poly-Si TFT
NEC	67	ND	Kagoshima	TFT
Seiko Epson	167	ND	Nagano Pref.	TFT
Seiko Instruments	20	ND	Akita Pref.	Diode Matrix
Sharp	447	3Q1993	Tenrie/Mie	a-Si TFT
Toshiba/IBM-J	134	2Q1991	Himeji	a-Si TFT

^aConverted at U.S.\$1=150 Yen.

KEY: TIT—thin film transistor; a-Si—amorphous-silicon; Poly-Si—poly-silicon

SOURCE: Dave Mentley, Stanford Resources, Inc., San Jose, CA, personal communication, Apr. 25, 1990; and Defense Science Board, "High Definition Systems Task Force, Final Report," Washington, DC, forthcoming.

flat panel market as high as \$11.7 billion by 1996.⁶¹ The display market is also primarily driven by consumer applications: 70 percent of the 1988 market was for consumer electronics; just 18 percent for computer applications.⁶²

The market for displays for HDTV could also be large. For example, if AM/LCDs became the display of choice, using the high-growth scenario above, screen production for HDTV would be nearly 6,000 times total world production of active matrix LCD

⁶¹David Lieberman, "Colorful Future for Flat panels," *Electronic Engineering Times*, Jan. 8, 1990, p. 71.

⁶²Edmond Branger, "Flat Panels in Focus," *Electronic Engineering Times*, Mar. 20, 1989.

screens today.⁶³ HDTV might then be an important driver of flat panel display technology as well as contributing to economies of scale in production. Even with a small market for HDTV, the special requirements of HDTV will drive large-area AM/LCD or other flat panel technology development.

STORAGE

The state-of-the-art in magnetic and optical storage technologies for studio use is already being pushed by the large volume and high rate of information flow requirements for HDTV and, to a lesser extent, related HRS.⁶⁴ Digital VCRs for studios will require much higher magnetic recording densities and information transfer rates through the use of improved magnetic materials, recording heads, and other techniques.⁶⁵ Sony, for example, has developed a prototype studio VCR that has a recording speed of 1.2 Gbps—five times faster than the previous record.⁶⁶ To similarly extend recording times on compact disks, the semiconductor lasers used will have to operate at higher frequencies than those used today, requiring advances in semiconductor lasers and reductions in production costs.⁶⁷ Matsushita has recently succeeded in storing 2.6 GB of video information on a single 12-inch optical disk.⁶⁸ These recording technologies will have many applications in the computer industry.⁶⁹

Such spinoffs from consumer electronics have already been widely seen. Magnetic and optical (compact disks) storage technologies were both originally developed for the consumer electronics market, but are now used widely in the computer

industry. In particular, compact disks are expected to have a profound impact on information handling generally.

Similarly, Digital Audio Tape (DAT) drives, originally developed for the consumer market, are expected to have a significant impact on the computer data storage market. DAT sales in the U.S. consumer market have been limited due to U. S.-Japan trade friction and issues of copyright protection; therefore, prices are expected to remain higher than if large volume sales had already been achieved. If approved, legislation currently pending in the Congress that requires copy-controlling devices in DAT machines may open up U.S. markets. DAT will be able to store about 1.3 GB of data on a cassette the size of a credit card and about 3/8-inch thick and will have data rates of roughly 1.4 Mbps.⁷⁰

There are also spinoffs between technologies. The hard drives used in computers are made by coating a very thin, high-quality layer of magnetic material on a metal disk. The technology to do this, and even the processing equipment, originally came from semiconductor wafer fabrication. A key technology for large-area, flat-panel displays will similarly be putting extremely thin, high-precision coatings over very wide areas. Once developed, this could have an impact on the production of semiconductors, and on magnetic and optical storage. The converse is also true. Thin-film technologies developed for the semiconductor industry could initially have an impact on flat panel production, although the impacts will likely decrease as the panel areas increase.

⁶³World total production of small pixel (not watches or calculators) passive LCD displays in 1988 was roughly 6.13 million units, of which Japanese firms produced 96 percent, U.S. firms 4 percent. World production of active matrix displays was 0.21 million units in 1988, essentially all Japanese firms. Assuming a distribution of 60 percent, 3- to 6-inch diagonal, and 40 percent, 6- to 12-inch diagonal and averaging, the area is approximately 4.6 million square inches of active matrix panels; and 135 million square inches of passive matrix LCDs. If high growth rate projections are realized, assuming each HDTV has a 40-inch diagonal (or 768 square inches for a 16:9 aspect ratio), then the total active matrix screen area produced will be 5,844 times today's production of active matrix screens; 200 times today's production of passive matrix. For the large areas required for HDTV, active matrix screens will be necessary. World LCD production figures for 1988 were supplied by Bob Whiskin, BIS Mackintosh, London.

⁶⁴Note that for consumer use, the extensive signal compression brings storage densities to near the level of current technology, which is doubling its storage capacity every 2.5 years. The video signal is not compressed before storage in the studio, however, to prevent the introduction of errors or artifacts.

⁶⁵Others might include improved error correction algorithms or data coding techniques.

⁶⁶"HDTV Faces Many Hurdles in Japan," *Electronic Engineering Times*, Apr. 10, 1989. And Messerschmitt, op. cit, footnote 13.

⁶⁷"HDTV Faces Many Hurdles in Japan," op. cit., footnote 66. Increasing information storage on today's CDs is difficult because the spot size on the CD is approaching the wavelength of the lasers used—the system is approaching the diffraction limit. To increase data storage, higher frequencies are needed.

⁶⁸"Digital HDTV Goes On Record," *ZEEE Spectrum*, September 1988, p. 26. Please note that gigabytes (GB) is a volume of information—like a bucket of water; whereas gigabits per second (Gbps) is a rate of information flow—like the rate of flow through a hose. These cannot be compared.

⁶⁹"Archives in Miniature," *PC Magazine*, Jan. 31, 1989.

⁷⁰Terry Costlow, "TechDiscord Rips Tape Industry," *Electronic Engineering Times*, May 29, 1989, p. 53; Eng Tan and Bert Vermeulen, "Digital Audio Tape for Data Storage," *IEEE Spectrum*, October 1989, p. 34.

Precision motors like those used in HD-VCRs will also be used in computer tape and disk drives, robotics, and elsewhere. **Today**, Japan is the world's largest producer of precision motors due to this synergy of uses among electronic **products**.⁷¹

The high-precision helical scan drives for VCRs are now made **primarily** in Japan, although a few are made in Korea. **Exabyte** of Boulder, Colorado purchases off-the-shelf 8mm camcorder-type tape drive mechanisms from Sony and uses them in a 2.3 GB tape system (the highest storage capacity to date) for computer data storage;⁷² they are totally dependent on the Japanese source. With the continuing move to higher density storage systems, firms that produce computer tape storage systems, but do not have access to helical scanning (VCR-type) tape drives are unlikely to survive.⁷³

The United States continues to hold a strong R&D and market position in some storage technologies, but has seriously lost ground in others. The United States has largely lost the floppy drive business, holding just 2 percent of world sales in 1987; but in the hard drive market, U.S. **firms** have fought back **successfully** and still hold a 60 percent or better share. 3M continues to be a major world-class producer of magnetic tape; but no U.S. **firm** produces the high-performance helical scan recorder drives. Only one domestic **firm**, Recording Physics in California, has the capability to produce the very high-performance materials needed for read/write VCR heads.⁷⁴

The United States lags in many areas of optical storage research, and has **little** presence in the

manufacture of optical storage devices. Over a dozen Japanese **firms** are developing or selling advanced **rewritable** optical disks and/or **drives**.⁷⁵ The optical data storage device market is expected to grow from \$400 million in the United States in 1988 to \$7.3 billion by 1993.⁷⁶

COMMUNICATIONS

With the declining costs of fiber, the extension of fiber to the home is expected to become more affordable. Some estimate fiber may be **cost-effective** for large, new housing developments by 1992. There are optimistic projections that 17 million homes and small businesses could be hooked up to fiber by 1999.⁷⁷ The very high information carrying capacity of fiber may make it the carrier of choice for HDTV in the **future**; and if the HDTV market develops, it could further stimulate the use of fiber—initially in the cable backbone and later to the **home**.⁷⁸ In the near- to mid-term, however, coaxial cable will continue to be the most important medium for carrying video signals to the **home**.⁷⁹

As HDTV begins to be networked via **fiber-optic**, it could be an important force behind the next generation of telecommunications equipment. HDTV will require wide bandwidths and, correspondingly, a wide bandwidth switching and control system at a cost consumers will pay (figure 5-4). Similarly, low-cost techniques will have to be developed for installing optical fibers to households. Software to operate and manage a fiber network must also be developed. Today, **software** is a significant fraction of the expense of **telecommunications**⁸⁰ and recent

⁷¹Yuji Akiyama, "Growing Demands of Precision Motors Are Supported by AVEquipment, Industrial Robots," *JEE*, February 1986, pp. 30-35. In particular, he notes that 40 percent of Japan's precision motors go to audio video equipment. Further, fewer than 10 producers in Japan are able to make motors of the precision needed for home VCRs, with a core deviation of less than 2 microns, a speed deviation of less than 0.02 percent and a price less than 1,500 yen.

⁷²Please note that this is the standard VCR tape drive as used by consumers today. Its recording capacity is in GBytes and cannot be compared to the experimental Sony HDTV studio tape drive above with a recording speed of 1.2Gbits per second.

⁷³Clark Johnson, Consultant, personal communication, Aug. 11, 1989; Oct. 26, 1989.

⁷⁴Ibid.

⁷⁵These include Sony, Sharp, Canon, Nikon, Olympus, Matsushita, Toshiba, Mitsubishi, Hitachi, Fujitsu, NEC, Ricoh, Pioneer. *Electronics*, September 1989, Special Advertising Section on Japan, p. 105. Roughly one-sixth of optical disk drive production for computer data storage applications, on a \$-basis, is done in the United States but essentially none for consumer applications is made here, and this is a far larger market today. Ron Powell, NIST, personal communication, Nov. 14, 1989.

⁷⁶Manny Fernandez, "Forecast '89-Mixed Emotions," *Electronic Engineering Times*, June 12, 1989.

"Fiber Optics: Getting Cheap Enough To Start Rewiring America," *Business Week*, July 31, 1989, p. 86.

⁷⁸Larry Wailer, "Fiber's New Battleground: Closing the Local Loop," *Electronics*, February 1989, p. 94.

⁷⁹Terrestrial broadcasting, of course, is the second most important in terms of household access and will continue to serve a very important role. Whether delivered by cable or terrestrial broadcasting, the three major networks are the most important source of programming.

⁸⁰Jules Bellisio, Bellcore, personal communication, Mar. 15, 1989.

Figure 5-4-Data Transmission Rates and Holding Times for Different Types of Data Communications

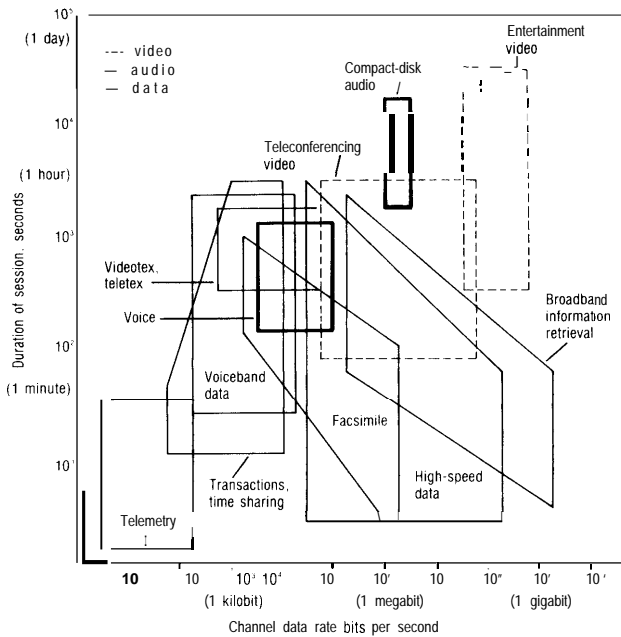

High-resolution video is among the most demanding of applications in terms of channel data rates, and also requires long holding times.

SOURCE: Stephen B. Weinstein, "Telecommunications in the Coming Decades," *IEEE Spectrum*, November 1987, p. 62. Used with permission.

failures in the telephone system caused by software suggest that additional development may be needed.

Consumer electronics has already had an enormous impact on **opto-electronics**. Much of the leading research in solid-state lasers has been, for example, by the companies that produce compact disk players. (Related high-performance solid-state lasers power fiber-optic networks.) These revenues have in turn provided the capacity to further advance the **state-of-the-art**.⁸¹

Despite pioneering fiber-optics and the electronics that drive signals through the fibers, the United States now lags Japan in many aspects of R&D and the production of fiber and associated electronic components. The United States still leads Japan, however, in linking these components together into complete communications systems.⁸²

PACKAGING/INTERCONNECT

Packaging/Interconnect (P/I) is the set of technologies that connect all of these **components**—semiconductors, displays, storage, and communications—into fictional systems. To connect a silicon chip to the outside world, the chip is mounted in a **plastic** or ceramic **package** that has tens to hundreds of metal leads. **These packaged chips are** mounted on printed circuit boards which, in turn, **are** interconnected via standard **multi-pin** connectors on a motherboard or a backplane (figure 5-5).

The cost of these **connections** increases rapidly at each level. Within the chip itself there are millions of tiny wires of **aluminum** **connecting** the transistors formed in the silicon. Despite their complexity, these **connections** typically cost just \$0.0000001 each because they are all formed in a single step using a **photomask**. The cost of the **connections** between the chip and the package it is mounted on are roughly \$0.01. The cost of **connections** between the package and the printed circuit board are roughly \$0.10 each. And the cost of **connecting** the printed circuit board to the backplane are roughly \$1.00 each.⁸³ Overall, the cost of **packaging/interconnecting** and assembling the electronic components, together with testing the system, accounts for roughly 30 to 50 percent of the total for a complex electronic system. Most system reliability problems are due to **interconnect** failures, and P/I technologies are a principal barrier today to achieving higher system performance.

Today's printed circuit board technology, for example, etches individual circuit patterns in copper foil laminated to sheets of fiberglass-reinforced epoxy. Multiple layers of unique circuit patterns can be **laminated** together with more epoxy. Packaged semiconductors and other components are then mounted on the board and **interconnected** via copper-plated holes to specific circuit patterns on different layers of the board. These holes account for a large fraction of the total board area and limit wiring densities and component spacing, and thus slow attainable system speeds while increasing system size, weight, and costs. The mechanical drilling process used to form these holes limits further reductions in their size.

⁸¹James J. Tietjen, David Saroff Research Center, Testimony before the Senate Committee on Governmental Affairs, Aug. 1, 1989.

⁸²Assessing Japan's Role in Telecommunications, "*IEEE Spectrum*," June 1986.

⁸³John S. Mayo, "Materials for Information and Communication," *Scientific American*, October 1986, p. 61.

Figure 5-5—Levels of Packaging/Interconnect

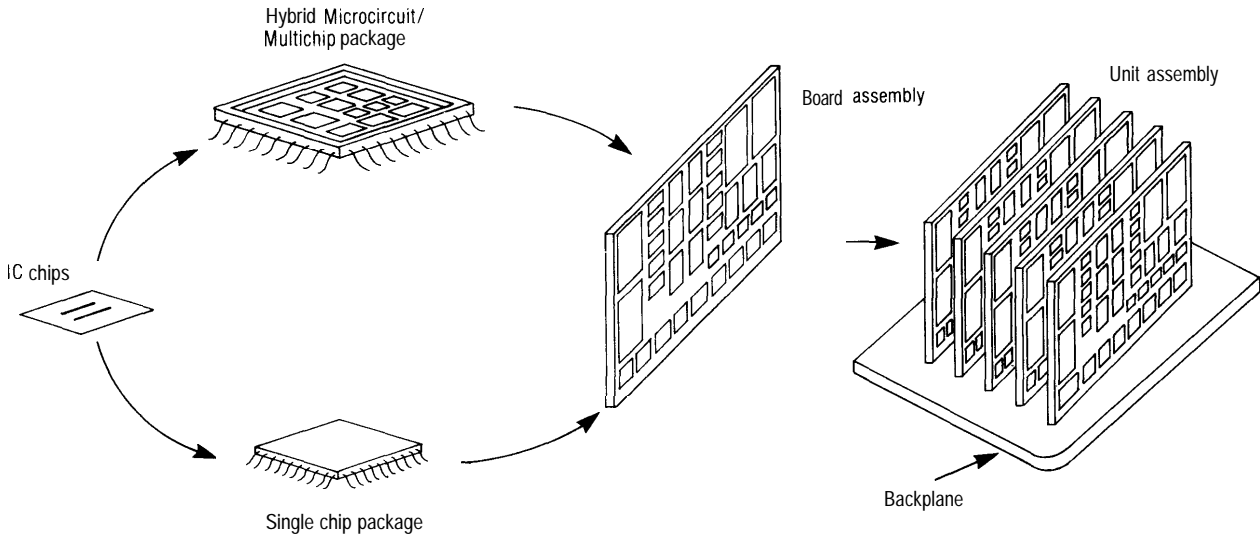

Transistors are interconnected via metal leads on the integrated circuit and is then mounted in a plastic or ceramic package. The packaged integrated circuit is mounted on a printed circuit board which, in turn, is mounted on a motherboard or a backplane.

SOURCE: Adapted from: National Security Industrial Association, Electronics Packaging/Intereonnet Task Force, "Electronics Packaging/Intereonnet: The Next Crisis for Cost-Effective Military Electronics," Washington, DC, draft, 1989.

As an example, **interconnecting** the 200 *or so* chips of a **supercomputer** processor, each chip having 250 input/output leads or more, would require a board with 40 layers of **circuitry**.⁸⁴ Advanced ICS may require 500 to 1,000 inches of **interconnect** wiring per square inch of board—two to three times the current practical limit. Designing and building such boards reliably is very difficult.

Small, high-density **multichip** modules are one means of improving P/I performance that is now gaining **favor**.⁸⁵ IBM's 3090 mainframe, for **example**, combines many chips in a ceramic module with 44 layers of wiring. These modules are then mounted and interconnected via a printed circuit board with relatively few layers.

In the longer term, the Japanese MITI and Key Technology Center flat-panel display consortium (ch. 2) intends to use **the lithography and thin-film** technologies developed for large-area flat panel displays to advance these printed circuit board densities through improved and lower-cost "Chip-on-Glass" technologies.

Chip-On-Glass technology mounts "bare" integrated circuits directly on lithographically printed glass substrates. This has several important advantages. Fine-line lithographic printing can provide perhaps ten times the wiring density attainable with the conventional copper-epoxy printed circuit boards described above. Increasing the wiring density also reduces the number of layers necessary. This reduces the space that must be allotted to the interconnections between layers. The savings are multiplicative. A conventional printed circuit board with 40 layers of copper-epoxy interconnect might be replaced with a lithographically printed glass substrate with just two layers of **interconnect**.⁸⁶ This provides substantial cost savings in both design and **production**.⁸⁷

Mounting the bare **IC** directly on the substrate bypasses several conventional packaging and interconnect steps with further corresponding cost savings and improvements in reliability. Together, the higher wiring density and use of bare chips can allow substantial increases in how close components are

⁸⁴Samuel Weber, "For VLSI, Multichip Modules May Become the Packages Of Choice," *Electronics*, April 1989, p. 106. This is roughly equivalent to a Fujitsu supercomputer.

⁸⁵Ibid.

⁸⁶Typically, a total of five layers might be needed: one for bonding pads for the chips, two for **interconnect**, one for power, and one for ground.

⁸⁷Barry Whalen, MCC, personal communication, May 12, Oct. 12 and 13, 1989; Jan. 23, 1990.

packed. This allows higher speeds and reduces system size and weight.

Chip-On-Glass technologies are used in special, high-performance cases today, but could be applied much more widely if large area lithography tools and related technologies were available. These techniques would allow many glass substrates to be produced at once on a large sheet, rather than tediously one-at-a-time.

The complexity and high speed of the chips used for HDTV will require the use of high-performance printed circuit boards. Complex **multilayer** printed circuit boards will be necessary and new materials may have to be developed to handle the high speeds at an affordable cost.⁸⁸ Although these are all available today **in** high-end commercial and military markets, manufacturing in volume for the HDTV market might force rapid improvements in production technology and dramatically lower their price.

The United States seriously lags Japan in many of these P/I and related assembly technologies. A recent National Academy of Sciences study found the majority of U.S. companies 4 to 5 years behind Japanese competitors in manufacturing process control and **in** factory automation for fabricating, assembling, and testing electronics **products**.⁸⁹ The United States also lags Japan and Europe in the use of surface-mount technology for connecting the chip to the printed circuit board (figure 5-6).⁹⁰ This technology saves space, increases reliability and performance, and reduces assembly costs. Tape Automated Bonding (**TAB**) technologies for packaging semiconductors, invented in the United States by GE but used more widely in Japan, **offer** significant increases in reliability at greatly reduced

labor and **cost**.⁹¹ **In** addition, TAB significantly improves semiconductor Performance.^{92*}

Producing P/I equipment and materials for HDTV or, more generally, for the flat-panel display market may provide economies of scale to a firm as well. Shindo Denshi, the largest Japanese producer of TAB tape, currently gets half of its sales from supplying producers of LCD displays. Some Japanese companies, such as Toshiba and **Matsushita**, have also developed proprietary “outer **lead** bonders” for **connecting** wires to the display. This technology is not for sale and might make it more difficult for U.S. firms to enter the **market**.⁹³

Many P/I and related **technologies**—**assembly**, test, surface-mount, tape-automated bonding—have been pushed the hardest by the consumer electronics market. The Sony Watchman television, for example, uses higher performance **TAB** than the NEC SX-2 **supercomputer**.⁹⁴ The consumer electronics market demands high reliability, small size, and low cost, but at the same time provides very large volume markets that allow even expensive, yet innovative, technologies to pay for themselves through **long**-term productivity improvements as experience is gained.

Because of these characteristics, consumer electronics often pushes the state-of-the-art in manufacturing technologies harder than lower-volume but higher-profit markets—especially for assembling components or systems. If the HDTV market develops, it may similarly provide manufacturers a testing ground for developing new assembly technologies with the volume needed to pay for themselves, as well as gaining valuable experience in assembly of sophisticated electronic systems that can be transferred to many other products.

⁸⁸Jack Fuhrer, Sarnoff Labs, personal communication, Mar. 15 and 20, 1989; Dayton, *op. cit.*, footnote 26. At the very high expected processing speeds, better PC board material maybe needed than standard epoxy as it is too absorptive at these high frequencies. Teflon boards have desirable dielectric properties and are now used in high-speed computers, but will be too expensive for the consumer market. It may be necessary to develop new materials that: are low-loss dielectrics; have good temperature characteristics; and bond well to copper. Alternatively, some labs are trying to avoid these high speeds on the board itself, which would require higher quality materials, by putting bus speed multipliers on each chip and **thinning** at the higher speeds only within the chip itself.

⁸⁹Manufacturing Studies Board, “The Future of Electronics Assembly: Report of the Panel on Strategic Electronics Manufacturing Technologies” (Washington, DC: National Academy Press, 1988),

⁹⁰Wesley R. Iverson, “Surface-Mount Technology Catches On With U.S. Equipment Makers—Finally,” *Electronics*, December 1988.

⁹¹Jerry Lyman, “Is Tom Angelucci’s Big Gamble Finally Paying Off?” *Electronics*, Feb. 17, 1986; “NEPCON Highlights the Dominant **Tape-Automated Bonding** Is Taking,” *Electronics*, Feb. 18, 1988. David Lammers and Ashok Bindra, “Tape Automated Bonding Sparks Renewed Interest,” *Electronic Engineering Times*, July 10, 1989, p. 53.

⁹²Pieter Burggraaf, “TAB for High I/O and High Speed,” *Semiconductor International*, June 1988.

⁹³James G. Parker and E. Jan Vardaman, “HDTV Developments in Japan,” TechSearch International, Inc., Austin, TX, 1989.

⁹⁴“The Future of Electronics Assembly,” *op. cit.* footnote 89.

Figure 5-6—Fraction of Integrated Circuits Used in Surface-Mount Packages for Japan, Europe, and the United States

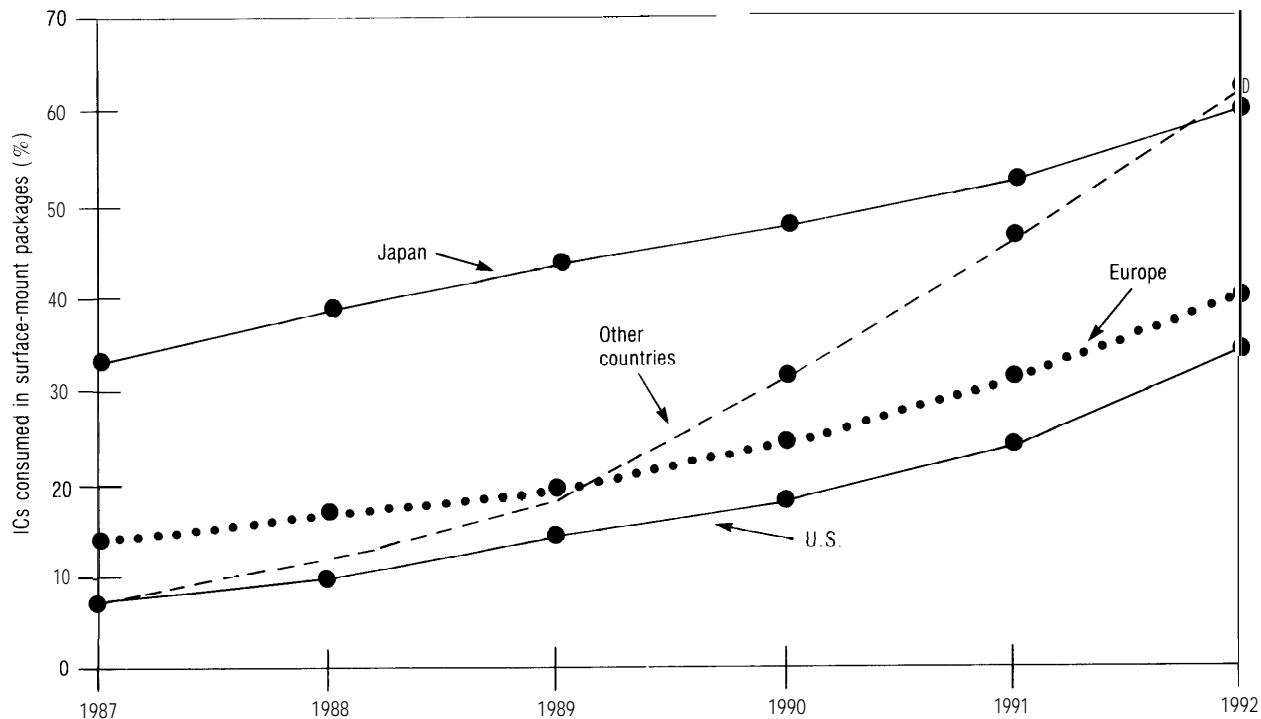

SOURCE: Wesley R. Iverson, "Surface-Mount Technology Catches On With U.S. Equipment Makers—Finally," *Electronics*, December 1986, p. 116. Used with permission.

Advanced TV Markets and Market Uncertainties

INTRODUCTION

The future growth and ultimate size of the various advanced TV and related markets is unknown. This may be unimportant for ATV-related R&D. The mere expectation of a large market seems to be inducement enough for many manufacturers to push the state-of-the-art in **ATV** technologies (ch. 5). In contrast, the growth rate and size of these various markets directly determines the economies of scale in production of the component technologies (e.g., displays, semiconductors, and data storage) as well as in the manufacturing processes for sophisticated electronic systems.

Development of HDTV markets depends on many complicated and unpredictable **factors**.¹ How much consumers will be willing to pay for HDTV-quality pictures is a matter of speculation. Consumers may prefer to spend their disposable income on a wider variety of **programming** choices, other entertainment systems, lower resolution interactive video systems, or more basic staples or amenities. For those consumers that are interested in purchasing HDTVS, there remain a series of “**chicken-and-egg**” problems to overcome:

- Consumers are unlikely to buy receivers until a wide variety of HDTV broadcasting is available; but broadcasters hesitate to offer HDTV programs until there are enough viewers to make it worthwhile.
- Consumers are unlikely to buy receivers until the cost comes down to acceptable levels; but manufacturers can't get the cost of receivers down until millions of consumers are purchasing HDTVS and enable large-scale mass production and streamlined manufacturing processes.

In contrast to the U.S. market-driven approach, the Japanese are actively trying to overcome these problems in the interest of developing their domestic market. This approach carries both risks and potential benefits: they may fail at a large scale but their chances of success are improved.

The **uncertainties** in the details of how the HDTV and other **ATV** markets will develop should not obscure important underlying trends in the technology. No matter what form video entertainment systems take in the future, they will increasingly use digital electronics for higher performance at reduced costs. For example, digital microprocessors are already common in television tuners and IDTVS have recently come on the market.

The rate at which fiber-optics is extended to the home and how it is connected may be similarly debated, but not its eventual widespread use. **Im**-proved economics and superior performance of fiber systems make this transition inevitable. The merging of digital video entertainment systems and fiber might then make a host of new information services possible. The question is how to provide a flexible **framework** for linking fiber to the home **and bringing** digital video systems into the home with the least overall disruption to the national telecommunications **infrastructure**—all at an affordable price.

A few of the possible market scenarios will first be examined qualitatively; then market projections by several leading groups will be discussed. The trend in technology towards digital/fiber systems will be reviewed. Finally, some of the market conflicts generated by the coming introduction of **ATV** services will be examined.

SCENARIOS FOR MARKET DEVELOPMENT

No one knows how the **ATV** market will develop. HDTV might prove irresistible to consumers and the market may grow rapidly, with corresponding economies of scale quickly lowering costs and making HDTV available to most families—perhaps even a second set. The HDTV market might grow more slowly: growing only after much larger and improved display technologies are available; after consumers are sensitized to the value of its higher

¹HDTV is focused on specifically here because it represents a significant cumulative change from today's TV that may or may not be made in roughly one step, depending on the choice of transmission standards.

picture quality; and after quality programming is available.² Less advanced versions of ATV such as IDTV or EDTV might prove more than adequate for most consumers, limiting HDTV to a small high-end residential market and to movie theaters, bars, or restaurants. Or perhaps lower resolution interactive video systems will reach a level of performance sufficient to stimulate **significant** consumer interest and vie with advanced TVs for consumer dollars.

An advanced form of HDTV might become the home information center, providing entertainment, computer, and telecommunications services in a single generalized piece of equipment. **Alternatively**, and perhaps more likely, these different services will instead continue to be primarily provided by separate, somewhat specialized pieces of equipment. Even in this case, the continuing decline in the cost of computer and advanced **telecom** systems will allow them into an ever larger fraction of households; while the home ATV continues to primarily provide entertainment.

In the longer term, having an advanced HDTV with the capability of interactivity—the equivalent of a computer, but for video images—might be very attractive to consumers. These systems might allow consumers to create personalized newspapers; browse distant databases; request more in-depth information on a news program; transmit an interesting movie clip to a friend; or even use an electronic yellow pages to see a video clip of the inside of a restaurant they want to try. Alternatively, such services might be provided by a **telecom/computer** system while the HDTV, again, simply provides **entertainment**. Or consumers may decide that such interactivity is not worth the cost or effort in either case.

Consumer Demand for HDTV

Little reliable information is available on consumer demand for high-quality video entertainment; the consumer response to higher quality pictures is ambiguous. Many consumers watch TV without the benefit of either rooftop antennas or cable, depending instead on rabbit ears or internal antennas. Many viewers still watch black and white TVs, at least as a second set—some 3.5 million B&W TVs were sold in the United States in 1987.³ On the other hand, cable TV has now penetrated over half of American households—both for the higher quality of picture it provides, and especially for the increased variety of programs it offers. Further, large screens are popular despite their high **cost**.⁴ The market for 25-inch and larger screens increased from 2.8 million in 1982 to 5.5 million in 1987.⁵

HDTV market research is similarly ambiguous. The few studies performed indicate that when compared to studio quality **NTSC** on today's relatively small displays, the viewer preference for HDTV is tempered by program content and viewing **conditions**.⁶ For example, when these (18- and 28-inch) displays were viewed **from** a distance where the additional detail provided by HDTV was lost, then viewers naturally had little preference. But viewed up close, 75 percent of the viewers **preferred** HDTV. These tests may simply reaffirm that to appreciate HDTV large displays are needed. Sony, for example, believes that a 72-inch diagonal is required to portray the full capability of their 1125/60 system.⁷

It is important to note that the pictures shown in these tests were studio quality. For **NTSC**, this is a significant improvement over what viewers normally see at home: the quality of **NTSC** TV is often poor due to transmission **degradations**.⁸ For any new

²FCC Advisory Committee on Advanced Television Services, **Farming Subcommittee Working Party 7: Audience Research**, Report, Feb. 14, 1989. This report notes the potential difficulties posed by an audience that becomes more sensitive to flaws after a fixed standard is locked into place.

³Electronics Industries Association, *Consumer Electronics Annual Review*, 1988 cd., Washington, DC.

⁴Lee McKnight, W. Russell Neuman, Mark Reynolds, Shawn O'Donnell, and Steve Schneider, "The Shape of Things to Come: A Study of Subjective Responses to Aspect Ratio and Screen Size," ATRP-T-87, Massachusetts Institute of Technology Media Lab, May 17, 1989.

⁵Thomson Consumer Electronics, Electronics Industries Association, **HDTV Information Packet**, 1989. Electronics Industries Association *Consumer Electronics Annual Review*, 1988 cd., Washington, DC.

⁶W. Russell Neuman, Suzanne Chambliss Neil, Lee McKnight, and Shawn O'Donnell, "Action Memo," House Subcommittee on Telecommunications and Finance, Feb. 1, 1989; W. Russell Neuman; "The Mass Audience Looks at HDTV: An Early Experiment," paper presented at National Association of Broadcasters' Annual Convention, Las Vegas, NV, Apr. 11, 1988.

⁷Larry Thorpe, Sony Corp., personal communication, Oct. 12, 1989.

⁸William F. Schreiber, Massachusetts Institute of Technology, "Comments Before the FCC on Advanced Television Systems and Their Impact on the Existing Television Service," Nov. 30, 1988.

standard, its susceptibility to transmission degradations are a key consideration (ch. 4).

Consumer demand for HDTV receivers will depend on the cost of the set and the availability of program material to view. In turn, receiver costs and program availability will be determined by the size of the market. These factors delayed the takeoff of the color TV market by some 6 or 7 years, from roughly 1955 to the early 1960s. **Only** the perseverance of RCA, led by David Sarnoff, and the investment of about \$3 billion (1988 dollars) kept color TV alive until the necessary critical mass of color **programming** became available and enabled the market to grow. Similarly, VCRs took off when rental stores for tapes became common (figure 6-1).⁹

The response of broadcasters to market demand for color **programming** in the early 1960s was less ambiguous. Broadcaster costs are roughly constant. A small change in market share (or ratings) then has a **significant** impact on profit margins. Therefore, broadcasters must compete vigorously for every possible market advantage. Between 1963 and 1966 the share of prime-time hours offered in color went **from** 20 to 100 percent, even though less than 10 percent of all households had a color TV (figure 6-2). Small changes in market share had enormous leverage over the broadcasters.

Consumer Demand for Interactive Video

Similarly, little reliable information is available on consumer demand for interactive video. Computers, rather than HDTVs, could be the platform for interactive services in the future. Interactivity is largely a **function** of flexible computing power and good software—in sharp contrast to the very high speed but relatively inflexible signal processing done by an HDTV. Declining costs have already brought computers into about 20 percent of American **homes**.¹⁰ A recent survey, however, found that home computers are used, on average, just twice per week; and many question whether they will penetrate the remaining 80 percent of households any

Figure 6-1—Sales of VCRs, VCR Prices, and the Growth of VCR Tape Rental Stores

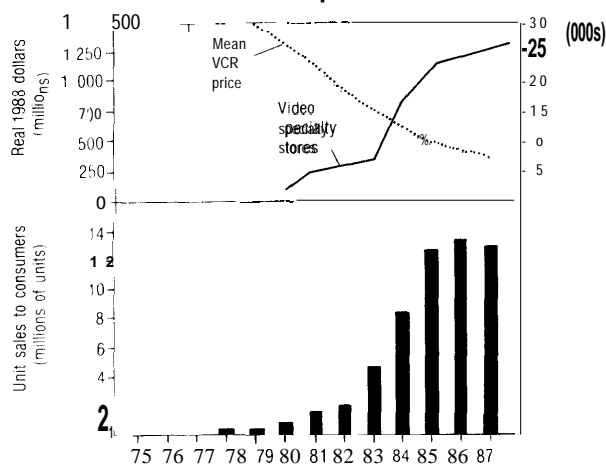

Note that the growth of the VCR market corresponds more closely with the opening of VCR tape rental stores than with the decline of VCR prices.

SOURCE: Boston Consulting Group, "Development of a U.S.-based ATV Industry," May 9, 1989 for the American Electronics Association. Used with permission.

time soon. On the other hand, the potentially large household penetration of advanced TVs might allow the delivery of a limited range of user friendly interactive information services to more of the public.

Although interactive **videotex** systems interest many, experimental systems tested by Knight-Ridder in Miami (1983-86) and Times Mirror in southern California (1984-86) failed. New efforts are underway by Bell South in Atlanta, NYNEX in Vermont, and IBM/Sear's Prodigy throughout the Nation.¹¹

In France, the Government-backed interactive **Minitel** system has been widely noted as a success. There are already *some* 4 million subscribers, although figures for 1988 showed an 8 percent decrease in residential use of **Minitel** services over the previous year.¹² **Minitel** succeeded by **making** use of the existing telephone network; by giving the subscribers interactive terminals; by keeping the

⁹Some have noted that the Betamax VCR format and RCA videodisc were hurt by a corresponding lack of programming. Others note that the problems with both those systems were inadequate technology: the Betamax format only provided 1.5 hours of recording time; the VHS format could give significantly more. Similarly the videodisc technology generated fuzzy pictures compared to alternatives. John Weaver, Liberty Television personal communication, Oct. 12, 1989.

¹⁰U.S. Department of Commerce, Bureau of the Census, "Statistical Abstract of the United States," table 1286, 1988 ed.

¹¹Fredric Saunier, "The Public Network Goes On-Line," *Telephony*, Apr. 3, 1989, p. 26; JohnMarkoff, "Betting on a Different Videotex Idea," *New York Times*, July 15, 1989, p. D5.

¹²Anne-Marie Roussel, "Minitel Gets New Terminal," *Communications Week*, Apr. 17, 1989, p. 52.

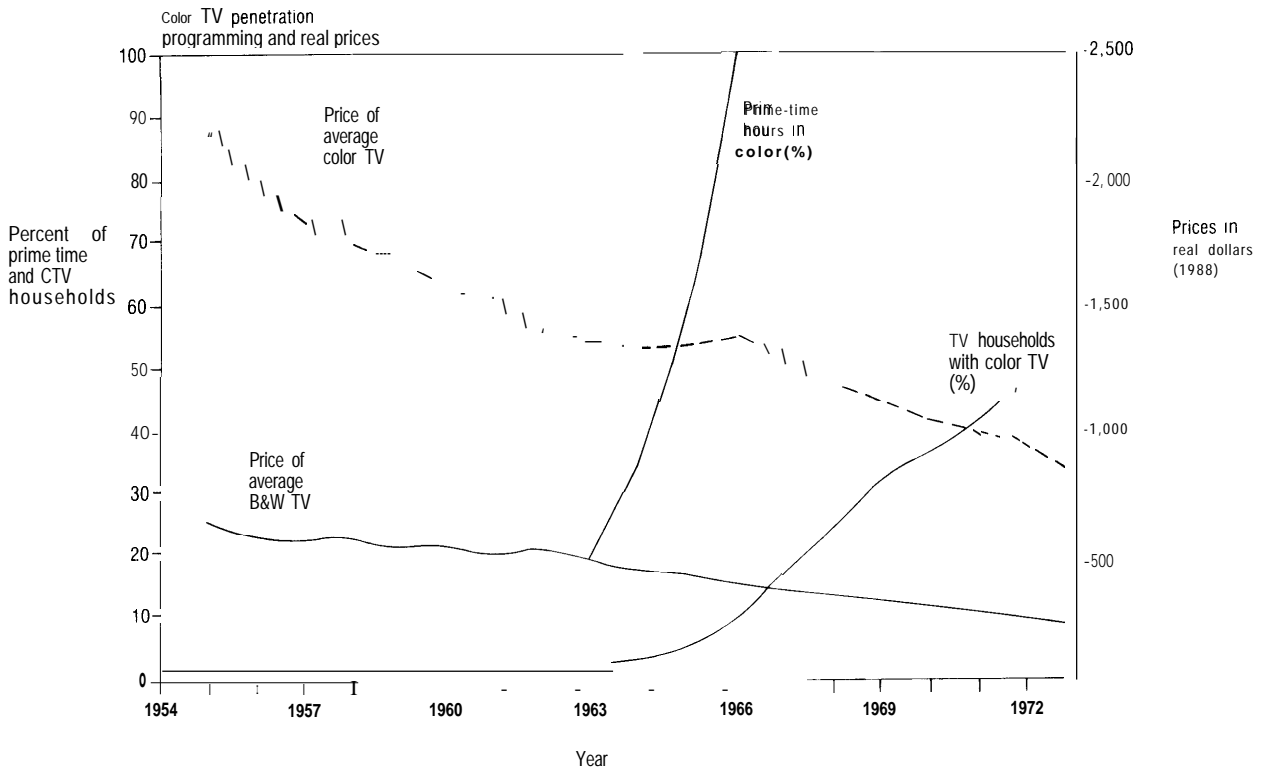
Figure 6-2—Penetration of Color TVs Into American Households, Average TV Prices, and the Share of Prime-Time Programming Devoted to Color TV

Note that the prime-time hours in color increased very rapidly beginning in 1963 and that the household penetration of color TVs followed, while the price of color TVs declined only slowly.

SOURCE: Boston Consulting Group, "Development of a U.S.-based ATV Industry," May 9, 1959 for the American Electronics Association. Used with permission.

terminals **simple**¹³ and their use intuitive; and by providing service on a pay-as-you-go **basis**.¹⁴ This kept total investment down; allowed potential users to experiment without having to invest heavily before knowing what they were going to get; and avoided the 'chicken-and-egg' problems with users demanding a broad range of services before signing on, and service vendors requiring many users before providing services. At this point, **Minitel** appears to be no more than a niche market, which has yet to pay for itself (at least in accounting terms), and maybe shifting towards more of a business **market**.¹⁵

Government Policies and Market Development

Government policies, particularly those of the FCC, could have a powerful influence on the way the

HDTV market develops. The marketplace might establish early standards for VCRs (which are not overseen by the government), for example, that are incompatible with government-backed standards for terrestrial and satellite broadcasting. If such incompatibilities arise between different media or if there is confusion in implementing the standards, consumers may hesitate in purchasing an expensive **ATV** that has only limited applicability. This could **significantly** slow **ATV** market development.

If the FCC allows **ATV** standards to improve incrementally, with IDTV, EDTV, and other gradual improvements in performance, then consumers may decide to stop short—at least **in** the near-term—full HDTV quality, depending on price and viewing

¹³The terminals are now believed to have been too simple and are being upgraded.

¹⁴Jean Grenier and Georges Nahon, "A Videotex Success Story," *Telephony*, July 27, 1989, p. 46.

¹⁵James Markham, "France's Minitel Seeks a Niche," *New York Times*, Nov. 8, 1988, p. D1.; Roussel, op. cit., footnote 12; Steven J. Marcus, "The French Videotex Connection" *Issues in Science and Technology*, fall 1987.

preferences. If the standards do not include intermediate enhancements, but move directly to full HDTV, then that market may or may not develop depending on consumers' perceptions of the products usefulness. If NTSC were phased out over a number of years in order to make better use of the broadcasting spectrum, then consumers would have no choice but to buy ATVs.

If the FCC requires stations to show the same picture in both NTSC and in HDTV simultaneously, then consumers may decide that the additional quality for the same programming is not worth it. Alternatively, HDTV quality programs and broadcasts might be reserved for special high-end markets, such as pay-cable. Producing and broadcasting HDTV quality programs on special, high-end channels alone presents the same "chicken-and-egg" problems: who invests first—viewers, broadcasters, or program producers? Even detailed consumer studies and market tests can not resolve some of these questions. Ultimately, risks must be taken, particularly by program producers and broadcasters to provide pictures that consumers will want to see. Clear and consistent government policies may be important if potential investors are to take these risks.

MARKET PROJECTIONS

Despite the lack of audience-based HDTV market research, a number of analysts have projected HDTV markets in the United States. Their forecasts have been made by analogy, i.e., by modeling HDTV penetration rates after those of previous successful consumer products such as black and white TV in the late 1940s, color TV in the early 1960s, and VCRs in the late 1970s.¹⁶ There are a number of remarkable market successes such as these. There have also been many market failures, such as the videodisc, quadraphonic sound, stereo AM radio, and others, due to factors ranging from poor technical performance and confusion over standards, to misperception of consumer interests.¹⁷

Most market projections for HDTV begin by examining the high-end markets where expensive, early production sets will likely be sold. Market analysts then estimate the rate at which cost reductions from economies of scale can bring the price of sets within reach of middle and lower income markets. These models implicitly assume that HDTV will eventually be successful. Furthermore, most of these models assume that the availability of IDTVs and EDTVs will not dampen the market for HDTV, but will instead be part of a natural progression to HDTV.

The projected market penetration rates for successful products normally follow an S-shaped curve.¹⁸ Sales are initially slow. When sales reach a market "take-off" point—typically observed to be a few percent of household penetration—they then grow rapidly. After several years of rapid growth, the market begins to saturate and sales level off to replacement levels. This behavior can be seen in the B&W TV, Color TV, and VCR markets for the United States and Japan (figure 6-3). Eventually, new products may come along that displace the earlier model and cause its sales to decline—such as the case of Color TV replacing B&W. The two principal variables in such scenarios are: 1) at what time the market "takes off" and 2) how rapidly the market grows after take-off.

HDTV market projections generally follow this form. The Japanese Ministry of Posts and Telecommunications (MOPT) assumes that the Japanese market will take off in 1993. In the United States, the Electronic Industries Association (EIA), National Telecommunications and Information Agency (NTIA), and American Electronics Association (AEA) assume that the market will take off in roughly 1994, 1997, and 2000 respectively. All four of these studies have reasonably similar rates of growth once the take-off point is reached (figure 6-2).

¹⁶Examples of such studies include: Robert R. Nathan Associates, Inc., "Television Manufacturing in the United States: Economic Contributions—Past, Present, and Future," Washington DC, Electronic Industries Association, Nov. 22, 1988; David Russell, "High Definition Television (HDTV): Economic Analysis of Impact," Washington DC, American Electronics Association, November 1988; Larry F. Darby, "Economic Potential of Advanced Television Products," Washington DC, National Telecommunications and Information Administration, Apr. 7, 1988. Reviews of these and other market studies are included in: Shawn O'Donnell, "Forecasting the HDTV Market," Neuman, et al., Feb. 1, 1989, op. cit., footnote 6, appendix; and in Kenneth R. Donow, "EIDTV: Planning for Action," Satellite Systems Engineering Inc., Bethesda, MD, for National Association of Broadcasters, April 1988.

¹⁷Steven P. Schnaars, *Megamistakes: Forecasting and the Myth of Rapid Technological Change* (New York, NY: Free press, 1988).

¹⁸Unsuccessful products follow other paths, including upside down "u" S.

Figure 6-3-Sales and Projections of Video Entertainment Technologies in the United States and Japan

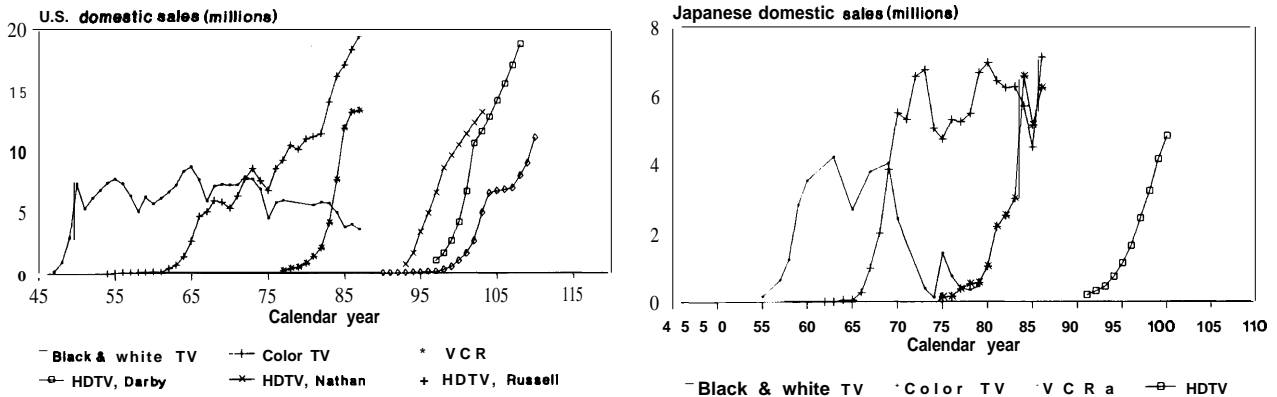

SOURCES: *United States*: Electronic Industries Association, "Consumer Electronics Annual Review," various years; Robert R. Nathan Associates, Inc., "Television Manufacturing in the United States: Economic Contributions-Past, Present, and Future," Washington, DC, Electronic Industries Association, Nov. 22, 1988; David Russell, "High Definition Television (HDTV): Economic Analysis of Impact," Washington, DC, American Electronics Association, November 1988; Larry F. Darby, "Economic Potential of Advanced Television Products," Washington, DC, National Telecommunications and Information Administration, Apr. 7, 1988.

SOURCES: *Japan*: Electronic Industries Association of Japan, various years; James Howard Wooster, "Industrial Policy and International Competitiveness: A Case Study of U.S.-Japan Competition in the Television Receiver Manufacturing Industry," Ph.D. Thesis, University of Massachusetts, 1986; Bob Johnstone, "Programming Better Quality TV," *Far Eastern Economic Review*, Aug. 11, 1988, p. 53.

Others have suggested that the HDTV market could be a big flop,¹⁹ emphasizing the high initial price of HDTVs and questioning whether consumers will see enough additional value over their current sets to justify paying the difference. IDTV and EDTV may themselves fill consumers' needs. Interactive video might create a new competing market, limiting sales of HDTVs (if Open Architecture Receiver designs are chosen as a standard then interactive video and HDTV might be the same market). The experts—the managers of many of the world's consumer electronics firms—have already bet more than \$1 billion that there will be a big market for HDTV. Whether they are right or wrong will only be clear in hindsight.

The value of the HDTV market is potentially very large. The Electronic Industries Association has estimated that HDTV receiver sales in the United States could total 13 million units worth about \$12 billion²⁰ retail (1988 dollars) in 2003, \$4 billion

more than would be the case if the market continued with standard TVs alone. The manufacture of movie production and broadcasting equipment would increase these values even more. Lower estimates include the NTIA Report with sales of \$5 to \$10 billion in 2003 for 12 million receivers and \$3 to \$6 billion for 10 million VCRs; and the American Electronics Association report with 2003 sales of 5 million HDTV sets in the United States worth about \$5 billion and world sales of about \$14 billion. AEA projections give VCR sales of 4 million units adding about \$3 billion in the United States; with \$8 billion in sales worldwide in 2003. In comparison, the overall U.S. consumer electronics market was worth \$30 billion in factory sales in 1987.²¹

These estimates are for home entertainment alone. Commercial and industrial uses may also be important. The Japanese MITI, for example, estimates that sales of consumer goods will be just 60 percent of the total sales of HDTV by 2000.²²

¹⁹See, for example, Bob Davis, "Will High-Definition TV Be A Turn-Off?" *Wall Street Journal*, Jan. 20, 1989, p. B1.

²⁰All values here are given in 1988 dollars. EIA values were discounted to 1988 dollars at 3.5 percent annual inflation rate from the EIA estimate of \$20 billion in 2003. NTIA and AEA published values were assumed to already be in 1988 dollars as they cited no inflation rates.

²¹Electronic Industries Association, op. cit., footnote 3.

²²"Television Makers Are Earning a Wide Crispness," *Business Week*, Dec. 21, 1987; and James G. Parker, TechSearch International, Inc., personal communication, Oct. 6, 1989.

Many widely circulated projections also contain highly questionable assumptions and numerous internal inconsistencies. For example, one report projects that the total TV market in the United States will double in the next 15 years, from 21 to 40 million sets—without identifying who will purchase all these sets as population growth slows and the population ages. It insists that most of the value added will take place in the United States, but glosses over the fact that the high-value manufacturing of electronics for **the** consumer TV market is today almost entirely offshore—leaving primarily screwdriver assembly operations in the United States. This report also ignores that with the longer term transition to flat panels or projection systems, much of the manufacturing and assembly remaining in the United States could also move offshore. The report assumes that **IDTV** and **EDTV** will have no impact on the HDTV market.

The precise course that **ATV** technology will take and the pace that it will enter cannot be predicted. The development of the **ATV** market will depend on a variety of factors, including: the rate of technological advance and the achievement of large economies of scale and learning; the consumer response to **IDTV**, **EDTV** and HDTV; the development of movies and programs at the appropriate level of visual quality for the **ATV** technology of choice; and the policies and standards chosen by the **government**, among others. Improvements in television technology are inevitable, but when and in what form they will take is largely unknown in the longer term.

MARKET PROJECTIONS AND THE RELATIVE IMPORTANCE OF HDTV

Forecasters have typically compared the relative importance of the HDTV, computer, and other markets by: 1) projecting constant growth rates into the future; 2) comparing the semiconductor content or other component demands for assumed market sizes; or 3) comparing ultimate market penetration rates and corresponding needs per user. None of these are very satisfactory or illuminating.

Extrapolating Current Growth Trends

Extrapolating current or expected growth trends at the same compound **annual** rate far into the future has been one of the most common techniques for making projections, but this form of analysis can

lead to highly exaggerated claims if done carelessly. For example, one report (“A”), has projected constant growth rates of about 5 percent in U.S. TV sales—with about 40 million TVs sold by 2003. A second report (“B”) has projected a constant annual growth rate of 10 percent for the computer industry and 7 to 8 percent for the semiconductor industry through 2008. Similarly, a third report (“C”) has projected constant annual growth rates of HDTVS and PCs, resulting in annual world sales reaching 180 million HDTVS and 135 million PCs by 2008.

These projections ignore the simple point that sales cannot grow exponentially forever. Markets inevitably saturate. For example, assume that the HDTV market will primarily be in the industrialized countries over **the** next 20 or so years and that replacements rates will be similar to the 7 year norm experienced for color TV today. With these assumptions, Report C’s projection of 180 million HDTVS sold annually in 2008 is roughly equivalent to an ultimate penetration rate of 1.25 HDTVS for every man, woman, and child in the industrial countries. Their projection for personal computer sales, 135 million annually in 2008, gives similarly high penetration rates. These are remarkable, and perhaps unrealistic, penetration ratios.

One can foresee a time that most people in the industrialized world will have a personal computer and an advanced TV. Most people in the United States today have direct access to both a TV and a telephone. There will also be a growing demand for computer technology from the developing countries. Making constant growth projections, as these reports do, is reasonable over short periods of time. Over longer periods markets are likely to saturate and growth projections must be reduced for when this occurs. Even if these very high levels of penetration are reached in the next 20 years, some market saturation will likely occur; but this is not considered in the constant growth rate projections made by these groups.

Comparison of two markets in the distant future based on constant annual growth rates is extremely sensitive to the assumptions. For example, report “C” assumes that personal computer sales will grow from current annual sales of 20 **million** at a rate of 10 percent; and that HDTV sales will grow from sales of about 5 million in 1994 at a rate of about 30 percent annually. At these rates, HDTV sales are greater than PC sales after the year 2000. But if

HDTV sales instead grow at a still remarkable pace of 20 percent annually, their total sales are slightly less than half those of PCs in the year 2008. Such sensitivity to (as yet) totally unknown underlying parameters makes such forecasting unreliable.

Comparing the Semiconductor or Other Component Requirements for Assumed Market Sizes

Forecasters have also compared the importance of different markets by the relative requirements for semiconductors and other components. This compounds the uncertainties of market growth rates with a lack of regard for the relative importance of various types of components. For example, some have compared the semiconductor content of HDTVS on a simple dollar basis with that of the entire semiconductor industry—rather than within the relevant market segments—and then dismissed HDTV as unimportant as its total semiconductor demand might be relatively small.

With such logic almost any market segment, when compared to the entire industry, can be dismissed as too small to be important. Supercomputers, minisupers, and parallel machines combined were a market of just \$1.36 billion in 1988.²³ Assuming a semiconductor content of 10 percent, they would consume just \$136 million in semiconductors, compared to a total world semiconductor market of some \$54 billion in 1988. Few would argue that the supercomputer industry is unimportant, however; it drives the state-of-the-art in a variety of chip, packaging interconnect, and other technologies as well as that of computers.

Similarly, (MOS) DRAMs were just a \$2.5 billion market in 1987 (before the price was driven up by the MITI-coordinated production cutbacks),²⁴ or less than 5 percent of the total world semiconductor market. But DRAMs drive many important semiconductor manufacturing technologies and the loss of DRAM manufacturing has been a serious concern

for both U.S. semiconductor producers and U.S. computer makers. Few would argue that we can do without this market segment despite its small size.

Semiconductors are expected to account for some 10 percent of the retail cost of HDTV receivers.²⁵ World sales of HDTVS in the various high-growth scenarios might reach \$25 billion or more by 2003. The corresponding HDTV semiconductor content would be \$2.5 billion. In comparison, the world market for semiconductors today is **already** more than \$50 billion with continued dramatic growth expected. Obviously, HDTV would not drive the entire semiconductor industry, but it could add to demand.

It would be a mistake, however, to dismiss the importance of HDTV within specific market segments. In high-growth scenarios, world HDTV use of DRAMs in 2003 could be as much as five times total world DRAM production in 1987 (ch. 5). But this says nothing about the relative importance of this market for DRAMs compared to other uses in 2003. Consider the following scenarios of demand. Both high and low (a tenth as large as the high) scenarios are presented to show the sensitivity of the forecast to underlying assumptions and to caution against the potential pitfalls in extrapolating constant growth trends into the future described above.

Assuming that the world computer, office automation, and telecom/fax markets (the principal users of DRAMs today) grow at an annual rate (by number of units) of 10 percent over the next 15 years and that the intensity of memory use within these products also increases, the resulting total annual growth rate in memory demand (by capacity) over this period would be 20 to 40 percent.²⁶ At a 20 percent growth rate for all DRAMs, the high-growth scenario suggests that HDTV would represent 25 percent of the total world demand in 2003. But at a 40 percent growth rate for all DRAMs, HDTV would account for just 3 percent of the world DRAM demand. Low

²³Tekla S. Perry and Glenn Zorpette, "Supercomputer Experts Predict Expansive Growth," *IEEE Spectrum*, February 1989, p. 26.

²⁴Charles H. Ferguson, "DRAMs, Component Supplies, and the World Electronics Industry: An International Strategic Analysis," VLSI Memo 89-554, August 1989, Massachusetts Institute of Technology, Cambridge, MA; Kenneth Flamm, "Policy and Politics in the International Semiconductor Industry," SEMI ISS Seminar, Newport Beach, CA, Jan. 16, 1989; and Kenneth Flamm, Brookings Institution personal communication, Oct. 25, 1989.

²⁵Electronics Industries Association "Consumer Electronics, HDTV, and the Competitiveness of the U.S. Economy," House Subcommittee On Telecommunications and Finance, Feb. 1, 1989. Semiconductors will account for a much higher fraction of factory costs, typically 20 percent or more. In the early stages of HDTV production the semiconductor content will probably be higher yet.

²⁶Because the market value per unit capability has declined so rapidly for computers and their underlying semiconductor technologies, it is important here to specify that this is by unit capacity rather than by dollar value.

growth scenarios for HDTV would reduce these market shares to 2.5 and 0.3 percent respectively.

In high-growth scenarios, the demand for digital signal and other processing chips for HDTV in 2003 (measured by processing capacity) could similarly be as much as 10 times world production of **all** logic chips in 1987 (**ch. 5**). HDTVS might contribute a small to **significant** additional demand to the total logic market, depending on the assumptions one chooses about growth in the computer and other sectors. In 1989, however, **DSPs** are forecast to be just 4 percent of the total dollar-value of the logic market.²⁷ **DSP** production for all other purposes would therefore have to increase at a phenomenal 45 percent annually for the next 15 years, or 250 times total, just to equal the high-growth scenario demand of HDTV.X Even in low-growth scenarios one-tenth this size, HDTV would still provide a **significant** demand for digital signal processing chips.

More generally, High-Resolution Systems (which include many computer, office automation, and **telecom/fax** markets) are likely to account for an important share of DRAM and **DSP** use in almost any scenario, due to the special processing requirements of video imaging.

If HDTV does provide a large market share for particular semiconductors such as **DSPs**, it could provide a firm significant economies in production. This has been widely observed for other consumer electronics components and markets. Producing a particular 16-bit digital-to-analog (D/A) converter chip for the large CD-player market, for example, drove their price from \$75.00 each to just \$3.75, while the price of less complicated 14-bit D/A chips that did not benefit **from** such a large market demand stayed at **\$60.00**.²⁹ Such production economies can also extend to individual firms that have the benefit of supplying several markets. This will also tend to insulate the firm from the cyclical swings in demand from a single narrow product segment.

As noted in **ch. 5**, HDTV is driving the **state-of-the-art** in many aspects of display technology, and the production volume of displays for HDTV is poten-

tially enormous—as much as 6,000 times larger **area** of AM/LCD display than is currently produced in the world. Whatever form video entertainment takes in the future, it is likely to continue to be a principal driver of technology and production economies of scale for displays.

Finally, the production of HDTVS may be important in driving the state-of-the-art in some aspects of **the manufacturing of** sophisticated electronics. **High-volume** production of consumer electronics has long driven the state-of-the-art in system manufacturing and has had important spinoffs to many other sectors. For example, all the Apple Macintosh's produced for the North American market are made on a TV assembly line in California that was imported from **Japan**.³⁰ The development of Tape Automated Bonding, surface mount technologies, and much automated insertion equipment was similarly driven by the consumer electronics industry (**ch. 5**). Large-volume manufacturing of HDTVS might also teach important lessons in manufacturing, especially because of the sophistication of its electronics.

Comparing Ultimate Market Penetration Rates and Corresponding Needs per User

Although technological progress will continue, the total production volume of computers, **ATVs**, and telecommunications equipment, etc. will at some point in the future likely **slow** to roughly replacement levels: there will be a limit to the number of computers, **ATVS**, videophones, etc. people will be able to put to effective use. At that time, the number of such devices used per person and their relative semiconductor and other component requirements will determine the importance of each market to the semiconductor industry.

Each household, for example, might have an **ATV**, computer, and videophone at home; a car with some electronics; and a computer/videophone at the office. In addition, there would be a number of "smart" devices such as microwave ovens, washing machines, coffee makers, and others that would use

²⁷See **ch. 5**; and Integrated Circuit Engineering Corp., "Mid-Term 1988," Scottsdale, AZ.

²⁸Such growth is possible, as seen in the past in the **DRAM** and other markets. If speech recognition or other such systems enter the market in large numbers over the next 15 years, **DSP** market growth might be significantly larger than this. This assumes that the cost per gate for **DSP** is the same as for the larger logic market.

²⁹AJ Kelsch, National Semiconductor, personal communication, Mar. 15, 1989.

³⁰Ferguson, *op. cit.*, footnote 24.

some **semiconductors**.³¹ In this scenario, the **ATV** would probably have the highest value display. It might then be the principal driver of display electronics and screen technologies and of their production costs. The computer would continue to be the principal driver of microprocessor technology and costs. The computer, videophone, and **ATV** would all play a role in driving fiber and wideband switching technologies, with the **ATV** perhaps playing an especially important role in leveraging the extension of fiber to the home. The computer and **ATV** would share in driving magnetic and optical storage media technology and costs, with the **ATV** taking a leading role in the near future due to its higher rate of information flow. From this perspective, Advanced TV could play an important role in several sectors.

Basing policy decisions on precise predictions of **future** markets in the electronics sector is clearly impractical. The market for HDTV, as envisioned today, may or may not develop. HDTV might open up entire new markets unforeseen today; or even substitute for personal computers and telecommunications equipment both at home and in the office. Alternatively, HDTV might be a flop and interactive computer systems prove to be a **winner**. Such market uncertainty makes investment decisions and policy formulation difficult; in the final analysis, faith may be an important factor in market success.

TECHNOLOGY AND MARKET TRENDS

The important underlying trends in the technology should not be obscured by the uncertainties in how the HDTV and other **ATV** markets will develop. No matter what form video entertainment systems **take** in the future, they will increasingly use digital electronics.

Digital systems allow the manipulation and processing of video information in ways that analog systems **cannot**. Significant improvements in the quality of the picture presented (ch. 4) and the potential for interactivity will be the result. Digital microprocessors are already common in television tuners, and **IDTVs** are now on the market. In the longer term, these advantages make the increasing use of digital electronics in TVs inevitable.

HDTV currently exerts greater demands than computer or telecommunications equipment for full-color, high-resolution, W-motion, real-time video. As a result, HDTV is pushing the **state-of-the-art** in a variety of display, display processor, storage, and certain related technologies. The **mutual convergence** of Advanced TVs, computers, and telecommunications towards digital video systems and the strong technological push provided by consumer video may result in significant linkages between these sectors.

Technological linkages between components and market segments are undeniably important and not easily **quantified**. Such linkages, however, can be overstated. For example, report "B" **cited above** stated that if the U.S. share of the HDTV **market** is 10 percent or less (weak), then the U.S. share of the world **PC** market would decline **from** today's 70 percent to just 35 percent in 2010; and the U.S. share of the world semiconductor market would decline from 41 to 20 percent in the same time period. The report is done so haphazardly, however, that it shows these drops in U.S. **marketshare** beginning in 1990. Thus, in their scenario the U.S. share of the world PC market even next year oscillates between \$34 billion and \$17 billion depending on whether or not we have less than 10 percent or greater than 50 percent of an HDTV market that is all but nonexistent-according to their **estimate, worth just** \$4 million in **the** United States and \$92 million worldwide.

As discussed in the previous chapter, there are numerous and important technological linkages between certain aspects of the technologies underlying HDTV, computers, and telecommunications equipment. Some of these linkages are strong; some are weak. In some areas, HDTV will drive the technology; in others computers or **telecom** equipment will drive the technology. For example, automatic test equipment will be primarily driven by the demands of the computer and telecommunication industries due to the greater complexity, variety, and flexibility of the circuits. Some HDTV proponents have **sacrificed** credibility and trivialized the importance of these linkages by arbitrarily assuming

³¹This ignores the industrial and military segments which are much smaller.

an instant, across-the-board reduction in market **share**.³² Linkages are usually much more subtle, are more often **identified** only in hindsight, and their impact on related industries and markets is often slow to develop.

The consumer demand for video entertainment and for consumer electronics equipment will always be large regardless of the **specific** course taken by **ATV** markets. The Japanese semiconductor industry today is strongly supported by sales of consumer electronics. Roughly one-fourth of total Japanese semiconductor output is currently used in consumer electronics, and TVs and VCRs are a major portion of **this**.³³

Perhaps more significantly, large volume mass production, typical of consumer electronics, drives the state-of-the-art in manufacturing technology for systems. These manufacturing technologies, as well as the management practices that go with them, will be important for producers of computer and telecommunications equipment.

In the past, U.S. firms could ignore the consumer electronics market at relatively less cost because analog technologies were used. With the shift of consumer equipment to digital electronics, the

linkages to the computer and telecommunication industries are becoming quite important and U.S. firms can no longer ignore this market with impunity.

The rate at which fiber-optics is extended to the home and the details of how it is **connected** and made use of is also uncertain. Fiber has already begun replacing the backbone of cable TV and telephone systems. In the midterm, mixed fiber, coaxial cable and copper pair systems (ch. 3) of the telephone and cable TV companies could provide a limited range of interactive video services.

In the longer term, most agree that the improved performance and ultimately lower costs of fiber (and associated electronic equipment) guarantee that it will eventually be used in all new construction and perhaps to replace copper pairs in existing buildings when maintenance costs become excessive. Ultimately, fiber will likely penetrate most households and could then provide a wide range of high-quality information services, however long that may take. The policy question is not whether or not to allow or promote this, but rather how to provide a **framework** for it to happen most flexibly with the least overall disruption to society.

³²Examples of this loss of credibility can be seen in: Congressional Budget Office, "The Scope of the High-Definition Television Market and Its Implications for Competitiveness," July 1989; David Wessel, "Mosbacher's Initiative on HDTV Is Getting Scuttled, Sources Say," *Wall Street Journal*, Aug. 2, 1989, p. B2; and Peter Passell, "The Uneasy Case for Subsidy of High-Technology Efforts," *New York Times*, Aug. 11, 1989, p. A1.

³³Flamm, *op. cit.*, footnote 24; Japan's VCR production accounts for 12 percent of total Japanese chip production: "TV's High-Stakes, High-Tech Battle," *Fortune*, Oct. 24, 1988.

The Decline of the U.S. TV Industry: Manufacturing

U.S. firms led the world in TV technology and production until the early 1970s. Then, foreign-owned firms gradually took control of the U.S. market. In particular, superior design and manufacturing techniques were implemented by Japanese manufacturers, in a financial and business environment that the Japanese Government took pains to make favorable to technology development and capital investment. Their government also assisted in developing overseas markets through a variety of export promotion incentives and protected the emerging Japanese companies from competition. The decline of the U.S. television industry was also hastened by dumping on the part of Japanese (and, later, other foreign) firms, and by the sluggish and inadequate response of the U.S. Government to that unfair trade practice. Finally, the diversification of Japanese producers from small, portable televisions into larger, higher value segments probably was speeded by Orderly Marketing Agreements, which limited the number of units that could be sold here.

Solid-state electronics were almost entirely invented in the United States, yet the Japanese pursued solid-state TV designs more vigorously. To reduce energy consumption by TVs, manufacturers requested that MITI sponsor a multi-company project to study the replacement of vacuum tubes with transistors. MITI assigned particular responsibilities to specific companies, and then circulated the results among all participants. The new designs, introduced in 1969 and 1970, used less than half the power of the older models.

MITI followed this with another multi-company research program on the use of integrated circuits (IC) in color TV. The change to ICS allowed dramatic reductions in the number of electrical components used in a TV. From an average of 1,200 components per color TV in 1971, Japanese firms reduced the count to just 480 by 1975. In the same time period, U.S. firms only managed to reduce the component count from an average of 1,150 to 880 (figure A-1).

This enabled all the components to be squeezed onto a single printed circuit board, which reduced the number of contact points and made the TV both easier to assemble and more reliable. In contrast, American firms continued

to use multiple-board designs for their ease of service. Thus, while Japanese firms designed faults out, American firms accepted faults as inevitable, designed for them, and in the process introduced them.

This difference in design philosophy could be seen at every stage of the manufacturing process. Japanese manufacturers worked to ensure "zero" defects by: performing elaborate pre-production testing of new designs; coordinating closely with suppliers to eliminate defects in incoming parts; and adopting automated assembly. By 1978, 65 to 80 percent of components were inserted automatically in Japan compared to 40 percent in the United States. This insistence on perfection even extended to the boxes that the finished TVs were shipped in. When Sanyo took over the Arkansas facilities of Warwick (U.S.), over a year was spent working with suppliers until the cardboard was flawless and the lettering perfect.

In contrast, American manufacturers allowed a certain percentage of incoming components to be defective, and relied on testing during and after the production process to catch the problems. As a result, typically less than 1 in 100 TVs had to be reworked during production due to

Figure A-1—Average Number of Electrical Components Per TV for U.S.-and Japanese-Made Color TVs

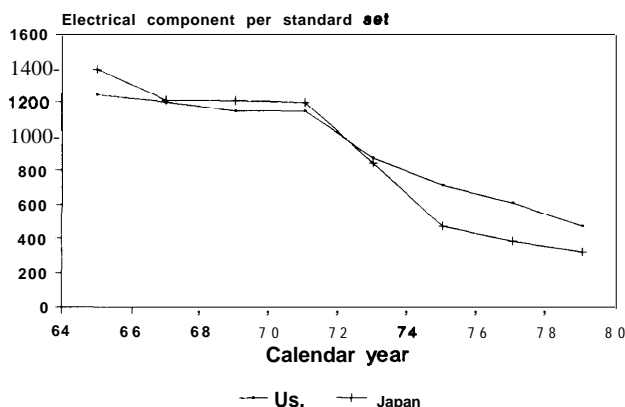

SOURCE: Based on data in Ira C. Magaziner and Robert B. Reich, *Minding America's Business* (New York, NY: Random House, 1983).

¹Sources for this section include: Harvard Business School Cases, "The U.S. Television Set Market, Prewar to 1970," "The U.S. Television Set Market, 1970-1979," "Sanyo Manufacturing Corporation-Forest City, Arkansas," "The Television Set Industry in 1979: Japan, Europe and Newly Industrializing Countries." Ira C. Magaziner and Robert B. Reich, "Minding America's Business" (New York, NY: Random House, 1983). J.M. Juran, "Japanese and Western Quality-A Contrast," *Quality Progress*, December 1978. James Howard Wooster, "Industrial Policy and International Competitiveness: A Case Study of U.S. Japanese Competition in the Television Receiver Manufacturing Industry," Ph.D. Thesis, University of Massachusetts, 1986. Developing World Industry and Technology, Inc., "Sources of Japan's International Competitiveness in the Consumer Electronics Industry: An Examination of Selected Issues," contractor report for the Office of Technology Assessment, 1980. James E. Millstein, "Decline in an Expanding Industry: Japanese Competition in Color Television," in *American Industry in International Competition*, John Zysman and Laura Tyson (eds.) (Ithaca, NY: Cornell University Press, 1983).

defects in Japan; many U.S. factories had to rework 50 percent or more. Strict control of the quality of incoming parts is also important if automation is to succeed. For example, **Philco's** automated circuit board assembly plant in Brazil ran for 3 months before they discovered that every **IC** from one of their suppliers had been defective. The cost of replacing the circuit board of every color TV produced during this period was an important factor in their owner's (Ford Motor Co.) decision to sell **Philco** to GTE-Sylvania and Zenith in 1973-74.

Reduced **re-working** of TVs during production, automation, and other factors reduced the assembly time for color TVs to 0.8 hours in Japan versus 2.6 hours in the United States in 1979 (figure A-2). Their TVs were also more reliable. Service calls for U.S.-made color TVs were five times more frequent than for Japanese-made TVs in 1974, dropping to two times the frequency by 1979 as U.S.-made sets improved.

These changes in failure rates had other impacts as well. Because of early reliability problems, many U.S. firms had developed dealer networks to sell and service TVs in the 1950s, as had Japanese electronics firms in Japan. The increasing reliability of TVs and the ability to market them through mass merchandisers in the United States, however, freed Japanese firms from supporting such dealers in the United States, and thus converted these dealer networks from a potential barrier to market entry into a liability for U.S. firms.

Meanwhile, the Japanese producers were protected from foreign competition at home. The government maintained strict controls on foreign direct investment, restricted import and currency exchange licenses, and set import quotas. Even without them, Japan's distribution systems and traditional business practices posed a formidable practical barrier to American exporters.

Some U.S. firms were competitive in manufacturing, however, and survived till quite recently (GE, RCA) or to

Figure A-2—Man-hours To Assemble Color TVs in U.S. and Japanese Factories

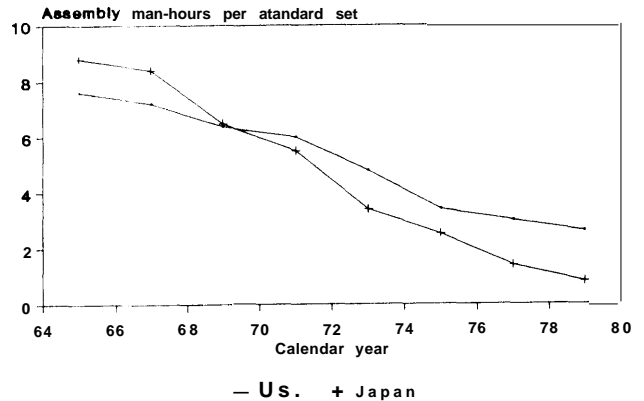

SOURCE: Based on data in Ira C. Magaziner and Robert B. Reich, *Minding America's Business* (New York, NY: Random House, 1983).

the present (Zenith) even in the face of dumping by some foreign firms. Had this dumping and other trade violations not occurred, other U.S. firms might have had the time to learn and apply superior quality control and production techniques, and have had the profit margins needed to invest in R&D and automation to be fully competitive. In this context, it is important to note that U.S. manufacturing practices were superior to those of the Japanese in terms of component counts and assembly man-hours (figures A-1 and A-2) until the early 1970s.

Foreign-owned firms now dominate the U.S. TV industry and much of the skill-intensive design and production of electronic components and subassemblies is done abroad, in many cases leaving primarily screw-driver assembly operations to be done in the United States.

The Decline of the U.S. TV Industry: Trade

Foreign **trade practices** were an important factor in the decline of U.S. television manufacturers. Domestic protection and coordinated pricing policies permitted Japanese firms to sell televisions in the American market at prices substantially below what comparable sets were sold for in Japan. The U.S. response to this dumping was sluggish and ineffective—in part because a statutory change that enabled a more effective response was not made until **1979—exposing** American firms to competition that drove down profit margins and increased the difficulty of making the needed investments to improve their manufacturing. The Japanese Government protected domestic producers **from** imports as **well** as foreign direct investment, and the nation's distribution system acted as a barrier to any firm that could surmount the government's restrictions.

Japanese TV manufacturers have high fixed costs, in part due to their customs of providing permanent employment and of maintaining exclusive distribution outlets. High-volume production was needed to cover these fixed costs but also provided significant economies of scale. Government **fiscal** policies and other factors encouraged heavy investment in plant capacity by Japanese manufacturers—in excess of domestic needs—to achieve these volumes. The large output was sold at a high profit in the protected domestic market and at low- or no-profit abroad: Japanese producers maintained domestic retail prices at least 50 to 60 percent higher than for comparable sets sold in the United States.¹ Imports would have broken this arrangement but were blocked.

The Japanese Government protected the profitability of domestic sales through tariffs, quotas, import and foreign exchange licensing, and restrictions on foreign direct investment. Tariffs on color TV imports were 30 percent in Japan until 1968 compared to 10 to 7.5 percent in the United States over the same period. Commodity taxes were reduced to less than 10 percent on sets entirely of domestic origin, but were maintained at 30 percent on those with larger imported picture tubes. Import certification took much longer and was more costly and stringent than the U.S. equivalent.

The Japanese industry blocked imports by denying distribution through their extensive network of franchised dealers, who carried only one manufacturer's products,

excluding all others. Sales through large retailers also proved difficult. In 1973, for example, Zenith attempted to export to Japan to take advantage of the exceptionally high prices for TVs there, but **MITI** reportedly pressured Zenith's trading partners and retail chains to limit distribution efforts.

As a result of these and other factors, sales of color TV imports in Japan totaled only 16,000 in 1974, 11,000 in 1975, and 452 in 1976—out of total color TV sales of almost 5 million.

At the same time, Japanese sold TVs at rock bottom prices in the United States. To ensure that the impact of this was on U.S. rather than Japanese producers, Japanese firms (including Hitachi, Matsushita, Mitsubishi, Sanyo, Sharp, and Toshiba) **allocated** U.S. retailers among themselves according to the so-called “five company” rule to eliminate **intra-Japanese** competition.

U.S. firms challenged the unfairness of Japanese trade practices, both in courts and through administrative processes. Action was taken on at least five separate fronts.

The first and longest proceeding began in 1968 when U.S. Customs received complaints about dumping violations. In 1971 the Department of Treasury found Japanese producers guilty of dumping,² but virtually no duties were collected or other actions taken until Congress overhauled the **antidumping duty law** in 1979.³ At that point, the Secretary of Commerce negotiated a settlement of approximately \$77 million for **antidumping** duties and other penalties. Zenith, having estimated its own damages as much larger than this, unsuccessfully appealed the settlement. The case was finally closed in 1987 when the government unsuccessfully tried to force Zenith to forfeit the \$250,000 bond it had been required to post in challenging this settlement.⁴

This and subsequent dumping findings against Korea, Taiwan, and Japan (most recently for 1986-87)⁵ resulted in the imposition of duties on TVs imported from these countries. Foreign efforts to rescind the duties have failed, but duties have reportedly sometimes been avoided by shipping TVs or components to the United States through third countries. For example, by transshipping through

¹Kozo Yamamura and Jan Vandenberg, “Japan's Rapid-Growth Policy on Trial: The Television Case,” *Law and Trade Issues of the Japanese Economy*, Gary R. Saxonhouse and Kozo Yamamura (eds.) (Seattle, WA: University of Washington Press, 1986).

²T.D. 71-76.5 Cust. B. and Dec. 151.36 Fed. Reg. 4597(1971).

³Kevin Kennedy, *Zenith Radio Corp. v. United States: The Nadir of the U.S. Trade Relief Process*, North Carolina Journal of International Law and Commercial Regulation (1988), vol. 13, p. 226.

⁴*Zenith Radio Corp. v. United States*, 823 F.2nd 518 (Fed. Cir. 1987)

⁵“Television Receivers, Monochrome and Color, From Japan,” 54 FR 13917, 1989.

Mexico, Matsushita was reportedly able to cut its tariff bill from 15 to 5 percent on color picture tubes.⁶

Second, the National Union Electric Corp. (U. S.) filed suit in 1970 and Zenith filed suit in 1974 against eight Japanese firms and their subsidiaries for violations of antitrust and **antidumping** laws. Most of the evidence in the case was ruled inadmissible by the District Court in 1981, including, for example, thousands of pages of documents seized by the Japan Fair Trade Commission in raids on corporate **offices**.⁷

The District Court's decisions were largely reversed by the Third Circuit Court of Appeals, which concluded that there was direct evidence of concerted action among the Japanese, including price fixing, use of the "five-company" rule, and false-invoice-and-kickbacks to avoid U.S. Customs regulations and **antidumping** penalties. The Court recommended that the case be sent to a **jury**.⁸

The Third Circuit Court of Appeals findings were narrowly reversed, 5-4, by the Supreme Court in 1986. The Supreme Court ruled that the direct evidence of concerted action among the Japanese found by the Third Circuit Court was irrelevant, because the Japanese could not have a motive to engage in predatory pricing in the United States—it would require the Japanese to sustain years of "substantial losses in order to recover uncertain gains." "9 Pricing behavior in the Japanese market was also deemed irrelevant to the antitrust charges because 'American antitrust laws do not regulate the competitive conditions of other nations' economies. "1°

The legal arguments notwithstanding, the Japanese firms' actions at issue in the case caused significant damage to U.S. firms. Both U.S. and Japanese firms had to cover their fixed costs. The Japanese Government permitted, if not encouraged, the creation of a protected

domestic market in which the Japanese firms were allowed to recover all of their fixed costs, **free** of any significant foreign competition. Japanese firms could then charge much lower prices in foreign markets, including the United States, while U.S. firms were forced to charge prices that covered their average total costs.

Third, Zenith petitioned the Treasury Department in 1970, requesting the imposition of a countervailing duty to offset the effective rebate of the commodity tax generally due on TVs which Japanese producers were receiving from their government for exports. In 1976, the Treasury Department found that the rebate was neither a "bounty" nor a "grant," either of which would have triggered the imposition of a duty. The decision was upheld unanimously by the U.S. Supreme Court in 1978.¹¹

Fourth, in 1972 the U.S. Department of Justice undertook investigations of collusion and of **false-invoice-and-kickback** schemes run by Japanese firms to circumvent U.S. dumping tariffs and **penalties**.¹² In 1977, Justice concluded that there was no evidence of collusion, but it brought charges against a number of **firms** for these kickback schemes. At least one U.S. retailer pled **guilty**,¹³ and at least one case was still unresolved in September 1989.¹⁴

Fifth, in 1976 a GTE request to the U.S. International Trade Commission (**ITC**) to investigate unfair acts by five Japanese firms was dismissed, but a request by **COMPACT**¹⁵ led to a 1977 **ITC** holding that there was injury due to increased imports. While the **ITC** therefore recommended higher tariffs on color TVs, the **Administration** responded instead by negotiating a voluntary Orderly Marketing Agreement.

⁶Committee to Preserve American Color Television, U. S. Congress, House Subcommittee on Telecommunications and Finance, Committee on Energy and Commerce, "Recommended Government Policies to promote the Evolution of a U.S. High Definition Television Industry," Committee Print 101E, March 1989.

⁷*Zenith Radio Corp. v. Matsushita Elec. Ind. Co.*, 494 F. Supp. 1190 (1980), 505 F. Supp. 1125 (1980), and 513 F. Supp. 1100 (1981)

⁸"In Re Japanese Electronic Products," 723 F.2d 238 (1983). See also "Japanese Electronic Products Antitrust Litigation," 807 F.2d 44 (1986) for the discussion of the case following the Supreme Court decision.

⁹One legal scholar noted that the Court analysis of predatory intent was in large part based on the most "conservative school of thought in the debate over predation," that of *Bork-McGee-Easterbrook*. See: Randolph Sherman, "The Matsushita Case: Tightened Concepts of Conspiracy and Predation?" *Cardozo Law Review*, vol. 8, p. 1121, 1987.

¹⁰*Matsushita Electric Industrial Co. v. Zenith Radio Corp.*, 475 U.S. 574 (1986).

¹¹*Zenith v. United States*, 437 U.S. 443 (1978).

¹²"Scandals; Kickbacks in Living Color," *Time*, June 13, 1977, p. 63.

¹³David Staelin et al., "The Decline of U.S. Consumer Electronics Manufacturing," Massachusetts Institute of Technology Commission on Industrial Productivity, December 1988.

¹⁴This case has been back and forth on repeated appeals and remands. 647 F.2d 902 (9th Cir. 1981); remanded to 518 F. Supp. 179 (C. J.). Cal 1981); reviewed 719 F. 2nd 1386 (9th Cir. 1983); cert. den. 104 S. Ct. 1441 (1984); 579 F. Supp. 1055 (C.D. Cal 1984); reviewed 785 F.2d 777 (9th Cir. 1986); cert. den. 479 U.S. 988 (1986); 677 F. Supp. 1042 (C.D. Cal 1988); reviewed 866 F. 2nd 1128 (9th Cir 1989).

¹⁵Committee for the Preservation of American Color TV.

The Decline of the U.S. DRAM Industry: Manufacturing

U.S. firms led the world in DRAM technology until the early 1980s. Japanese firms then gradually took control of the world market, in part because many U.S. producers could not match Japanese efforts at critical points in the technology's **lifecycle**. Heavy investment of money and manpower and close attention to high-quality manufacturing were important factors in the Japanese success. In addition, Japanese efforts have been abetted by violations of trade law. As a result, Japanese firms now control 70 percent of the total world **DRAM** market and 85 percent of the advanced 1 Mbit DRAM market.

Two engineers designed Intel's (U. S.) pioneering **1K** (1,000 bits or binary memory cells) DRAM in 1970-71 and just three engineers designed Intel's **16K** DRAM. In contrast, one of today's major Japanese DRAM producers reportedly assigned 50 select engineers to design their **1K** DRAM and 100 to design their **16K** DRAM. This allowed greater specialization, more careful attention to issues of manufacturability, and more rapid development of the designs.

Japanese firms invested heavily in **plant** and equipment in the **mid-1970s**. In contrast, U.S. producers cut investments due to the 1974-75 recession and were then unable to meet the demand when U.S. semiconductor markets boomed in 1979. Japanese producers stepped **in**—offering **16K** DRAMs as licensed second sources for the industry-standard **Mostek** (U. S.) design—and, by the end of 1979, had **captured** 40 percent of the world **16K** DRAM market.

Manufacturing quality began to appear as an issue in the late 1970s. Japanese **16K** DRAMs, for example, had much lower failure rates than those of U.S. firms (table C-1)—even though nearly all began with the **Mostek** design. It took several years for U.S. firms to reduce failure rates to comparable or lower levels.

Table C-1—U.S.-Japan 16K DRAM Failure Rates
(parts per million)

	1978	1979	1980	1981	1982
Japanese vendors	0.24	0.20	0.16	0.17	0.05
U.S. vendors	1.00	1.32	0.78	0.18	0.02

SOURCE: Hewlett Packard, William F. Finan, and Annette M. Lamond, "Sustaining U.S. Competitiveness in MicroElectronics: The Challenge to U.S. Policy," in *U.S. Competitiveness in the World Economy*, Bruce R. Scott and George C. Lodge (eds.) (Boston, MA: Harvard Business School Press, 1985).

U.S. firms lost even more of the DRAM market in the next generation due, in part, to relatively less competitive manufacturing. Chipmakers normally design chips as small as possible to reduce the likelihood that any one chip is contaminated by a stray microscopic dust particle and to increase the number of chips produced per wafer processed. Determined to leapfrog the Japanese in quality and cost, most U.S. producers designed much smaller and more sophisticated 64K chips than the Japanese, but were consequently slower than the Japanese in completing the designs and in solving related manufacturing problems.

In contrast, the Japanese successfully **produced** 64K DRAMs by slightly modifying and scaling up **their 16K** DRAM designs. The resulting chip was **nearly** 50 percent larger than the leading American designs, but they achieved good yields by using higher purity chemicals, by greater capital investment in **cleanrooms** and automation, and by superior quality-control techniques.

The simple design allowed the Japanese firms to get to the market first. High yields also lowered the overall cost per chip and gave them a greater production output per unit of capital investment and per labor hour than U.S. firms. By the end of 1981, the Japanese held 70 percent of the world 64K DRAM market. U.S. firms cut the Japanese share to 55 percent by **mid-1983** after entering the market in volume, but most U.S. firms subsequently abandoned the market due to Japanese dumping **in** the **mid-1980s** and/or due to problems they encountered in manufacturing subsequent generations of DRAMs competitively.

Issues of manufacturing process arose again as firms made the transition from the 256K to the **1M** (1,000,000 bits) DRAM. Table C-2 compares the production yields and costs for a lower-yield U.S. manufacturer—a major U.S. firm that subsequently dropped out of the **DRAM** business—with that of Toshiba, the world leader in **1M** DRAM production.

The U.S. firm's design and manufacturing process had several serious shortcomings that allowed no **margin** for error. For example, in etching the silicon wafer to create the circuit elements, the U.S. firm's process formed sharp vertical walls. In previous generations of DRAMs this would not have been a problem. But with the dimensions of the **1M** DRAM circuitry shrinking to just 1/100 **the** diameter of a human hair, sharp vertical walls prevented

¹Sources for this section include: Peter D. Nunan, Sematech, personal communications, May 11, June 22, Aug. 4, and Oct. 10, 1989; Brian Sante, "1K-Bit DRAM, 1970," *IEEE Spectrum*, vol. 25, No. 11, 1988; William F. Finan, Jeffrey Frey, "Study of the Management of MicroElectronics-Related Research and Development in Japan," contractor report prepared for the Office of Technology Assessment, November 1988; *Competitive Edge: The Semiconductor Industry in the U.S. and Japan*, Daniel I. Okimoto, Takuo Sugano, and Franklin B. Weinstein (eds.) (Stanford, CA: Stanford University Press, 1984); William F. Finan and Annette M. Lamond, "Sustaining U.S. Competitiveness in Microelectronics: The Challenge to U.S. Policy," in *U.S. Competitiveness in the World Economy*, Bruce R. Scott and George C. Lodge (eds.) (Boston, MA: Harvard Business Press, 1985).

Table C-2—U.S.-Japan 1 M DRAM Manufacturing Cost Comparison

Operation	Lower yield U.S. manufacturer 3Q 1986	Toshiba 3Q 1986
Start wafer cost ^a	(Epi) \$60.00	(Bulk) \$25.00
Processed wafer cost.....	\$335.00	\$300.00
Chip size (square mm).....	73	54
Total chips possible (assuming a 125 mm wafer).....	151	205
Wafer probe yield.....	25%	68%
Number of good chips.....	38	139
Packaging cost.....	\$0.25	\$0.25
Assembly yield.....	92%	92%
Final test cost.....	\$0.20	\$0.20
Final test yield.....	85%	85%
Total manufacturing cost..	\$11.83	\$3.31

NOTE: These are representative values to indicate relative manufacturing costs for these two firms at a particular time. These firms are at different points on the learning curve for 1M DRAMs in 1986, but process design flaws probably would have prevented much higher yields for the U.S. firm.

^aThe starting wafers, Epi and Bulk, refer to different types of wafers.

SOURCE: Peter D. Nunan, Sematech, personal communications, May 11, June 23, Aug. 4, and Oct. 10, 1989.

subsequently deposited material from being effectively etched out of the corners, causing the circuitry to short-out (figure C-1).

The Toshiba engineers recognized this pitfall and developed a new technique which formed sloped rather than sharp vertical walls (figure C-1). The resulting process was highly robust. When transferred to **Siemens** in Germany and to **Motorola** in the United States, yields were high even with the very first wafers processed and even with relatively less experienced line workers.

Technical management and quality philosophy proved to be key problems for the U.S. firm. Its design engineers developed their DRAM process and prototypes in the laboratory, and then 'threw the design over the fence' to the manufacturing engineers. The design engineers recognized the difficulties of producing 1M DRAMs with their design: they attempted to compensate by specifying a high-quality starting wafer, by keeping the chip size relatively large, and by including a very large number of redundant memory cells on the chip as backup (table C-2). They were relying on inspection and correction after production to provide usable DRAMs rather than designing quality in.

The manufacturing engineers were unable to get (wafer probe) yields up to competitive levels under factory conditions. They protested that the process had no margin for error and was not readily manufacturable, but didn't have the resources or knowledge to do proper analysis and implement improvements. The designers insisted that they had developed a robust and manufacturable process and stayed away from correcting the problem. In contrast, the engineers and scientists who developed the Toshiba

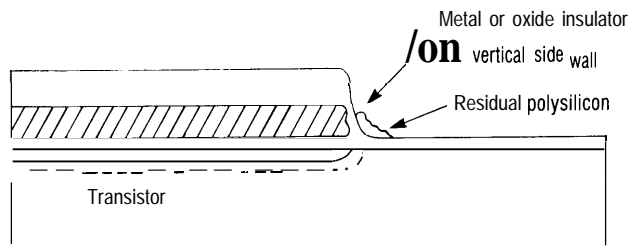
Figure C-1—Cross-section of 1M DRAM Storage Cell

Lower-yield U.S. manufacturer design

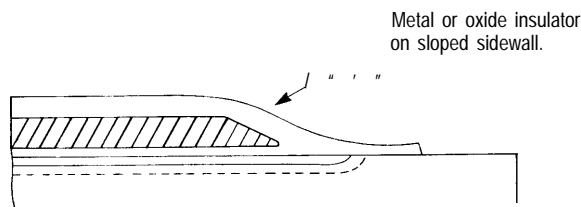

Toshiba design

A. Cross-section of lower yield U.S. manufacturer's design showing the sharp corners from which it was difficult to etch residual polysilicon.

B. Cross-section of Toshiba design showing the sloped sidewall.

SOURCE: Peter D. Nunan, Sematech, personal communication, Oct. 10, 1989.

process were also responsible for improving the yield on the factory floor. Even if the Japanese had not been dumping DRAMs in the United States in the **mid-1980s**, the 1M DRAM design and manufacturing process of this low-yield U.S. manufacturer might never have been competitive.

The loss of the DRAM market may be particularly damaging to the U.S. chip industry. DRAMs are known as a technology driver because they push the limits in certain kinds of process technologies. Loss of DRAM production will likely cause U.S. firms to lag the Japanese in developing certain kinds of manufacturing processes important in the production of many types of chips.

U.S. firms face formidable obstacles should they choose to reenter the DRAM market. From \$5 to \$10 million in the mid- to **late-1970s**, the cost of a single minimum-efficient scale, state-of-the-art DRAM production facility has risen to roughly \$200 million today, and is expected to approach \$400 million for the **next-generation** 16M DRAMs. The human skills to design and produce leading-edge DRAMs also take many years to develop.

Siemens has committed \$1.6 billion to develop or acquire 1M and 4M DRAM technology and production facilities. Even armed with IBM's DRAM designs, however, U.S. Memories failed to raise \$1 billion to enter

DRAM production. Similar investments needed for producing state-of-the-art semiconductors generally are all but impossible for small- and medium-sized firms. As a result, many American companies are forced to rely on Japanese and other foreign firms to produce their chip designs.

Some observers see the relatively low level of funding for **Sematech**—roughly \$200 million per year—and the corresponding decision to not pursue large-volume production of **DRAMs** as critical constraints. They argue that a high-volume operation is essential for testing yield and

reliability, and that issues of technical management and quality techniques—such as for the lower yield U.S. manufacturer described above—can otherwise be swept under the rug. As one **Sematech** engineer, frustrated by what he feels is an inadequate response to the Japanese challenge, put it,

It's as if the Soviets, having already taken the lead in the space race, had announced in 1961 that they were going to send a man to the moon, and the U.S. response was to focus on selected aspects of rocket science.

Appendix D

The Decline of the U.S. DRAM Industry: Trade¹

The Japanese Government protected the Japanese semiconductor industry when it was weak and, as it strengthened, supported its move into international markets. Conversely, American trade policy largely failed to prevent serious damage to U.S. industry caused by trade violations.

Scientists and engineers in the United States invented essentially all of modern solid-state electronics. By one accounting, of some 103 major product and process innovations in the semiconductor industry between 1950 and 1978, 90 were by American firms. Despite the technological lead of U.S. firms, they were never able to convert it into market share in Japan as they did in Europe.

U.S. firms found it all but impossible to establish subsidiaries in Japan or joint ventures with a significant share of the equity—unless the Japanese partner was given access to new technology or other appreciable benefits. Thus, whereas U.S. firms had established 46 subsidiaries in Europe by 1974, including 18 **manufacturing** operations, only Texas Instruments (**TI**) had a manufacturing operation in Japan.

TI succeeded where other U.S. firms failed because of its strong U.S. patent on the integrated circuit (**IC**). The Japanese Government refused to give **TI** permission to establish a wholly owned subsidiary in the early 1960s; in turn, **TI** refused to license its **IC** patent in the United States to Japanese firms. This generally stopped exports of Japanese **ICs** to the United States, but it did not stop Japanese firms **from** producing **ICs** for their domestic market as **TI's** application for a Japanese patent was refused. (**TI** applied for a Japanese patent on its invention of the **IC** in February 1960 but did not receive the patent until November 1989. The patent is estimated to be worth \$500 million annually in royalties to **TI**.)

Japanese firms rapidly gained expertise in IC fabrication—making TI's entry into their market evermore difficult the longer it waited to settle. In 1968, **TI** settled for a **50:50** joint venture with Sony; licensed NEC, Hitachi, Mitsubishi, Toshiba, and Sony; and agreed to limit its share of the Japanese **IC** market to less than 10 percent. Firms with weaker patent positions did not succeed in establishing manufacturing subsidiaries in Japan until much later.

Tariff and non-tariff barriers limited imports into Japan as well. Tariffs were roughly double those of the United States until the early **1980s**. Imports of **ICs** with more than

200 elements were **banned** until 1976, limiting the import market to the most simple types.

Unable to penetrate the Japanese market, most U.S. firms licensed their technology to Japanese firms as a means of realizing some earnings. The Japanese **Government** required that foreign firms license all Japanese firms so requesting at a single royalty rate. This prevented the competitive bidding up of the license fees; and the broad licensing prevented any one firm from capturing monopoly revenues. Competition among firms was thus effectively shifted **from** innovation downstream into **manufacturing**.

The battle for control of the DRAM market began in the late **1970s** with the strong Japanese push in 16K DRAMs. The 1979 boom in semiconductor demand created a capacity shortage among both Japanese and **American** producers. Japanese firms responded by increasing their export of chips to capture and hold market share **abroad**, while importing the same chips to **fill** their domestic needs until they could expand their production capacity. U.S. firms rushed to fill Japanese orders in the hope that this was a market opening, resulting in the highest levels of semiconductor imports into Japan at anytime between the early- **1970s** and 1989 (figure D-1). As additional capacity came on line, however, the vertically integrated Japanese producers cut back imports of U.S.-made DRAMs while hanging onto their market share gains abroad.

Japanese firms pushed DRAM prices down sharply in the early **1980s** (figure D-2). Repeated allegations of dumping were made, but no formal action was taken because it was **difficult** to distinguish the effect on price of dumping, if any, from that of the high value of the dollar. Over half of the U.S. DRAM producers dropped out of the market during this period.

The remaining American firms followed the Japanese lead in heavily investing in capital equipment in 1983-84. When recession hit the semiconductor industry in 1985-86, the large overcapacity and other factors drove down DRAM prices. Japanese firms lost an estimated \$3 to \$5 billion during 1985-86, while American **firms** lost an estimated \$2 billion.

Severe price competition also occurred with other commodity chips such as EPROMS. In 1985, Hitachi told distributors to quote 10 percent lower **prices**—irrespective of costs—than competing American firms

¹ Sources for this section include those cited in app. C and: John E. Tilton, "International Diffusion of Technology," *Brookings Institution*, 1971; Dennis J. Encarnati on, "Cress-Investment: A Second Front of Economic Rivalry," *California Management Review*, vol. XXIX, No. 2, Winter 1987; The Department of Commerce, "A Report on the U.S. Semiconductor Industry," 1979; "The United States Government Trade Policy Response To Japanese Competition in Semiconductors: 1982-1987," *OTA Background Report*, September 1987; Clayton K. Yeutter, "The Japanese Left Us With Little Choice," *New York Times*, Apr. 5, 1987; Andrew Pollack, "Chip Pact Falls Short of Goals," *New York Times*, Aug. 2, 1988; William F. Finan, Chris B. Amundsen, "Modeling U. S.-Japan Competition in Semiconductors," *Journal of Policy Modeling* 8(3): 305-326 (1986); John Burgess, "Japan Gives U.S. Firm Circuit Patent," *Washington Post*, Nov. 22, 1989;

Figure D-I—U.S. Share of the Japanese Semiconductor Market, 1973-66

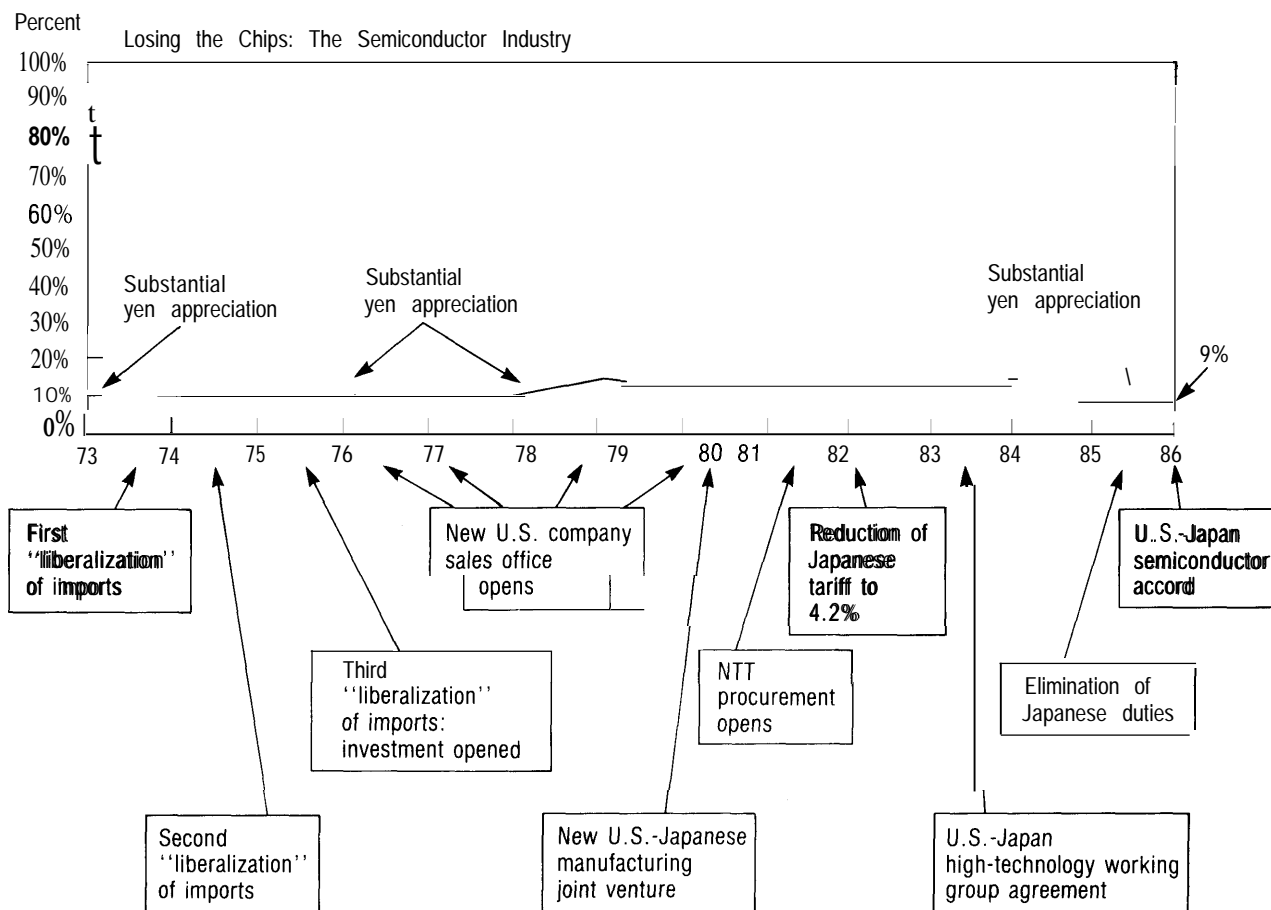

SOURCE: Clyde V. Prestowitz, Jr., *Trading Places: How We Allowed Japan To Take the Lead* (New York, NY: Basic Books, 1988). Used with permission.

until the sale was won, while guaranteeing a 25 percent distribution profit. From January 1985, when the Japanese entered the 256K EPROM market, to August 1985 prices fell from \$17 per chip to less than \$4, while the estimated Japanese production cost alone was \$6.34.

In response, U.S. semiconductor firms filed **anti-dumping** cases against Japan in 1985 for below-cost sales of 64K DRAMs, and the Department of Commerce itself filed an **antidumping** case against Japan for below-cost sales of 256 DRAMs and EPROMs. The U.S. **International Trade Commission (ITC)** found that dumping had occurred. For example, constructed prices indicated that DRAMs were being sold at half their estimated production cost. A trade agreement was subsequently reached in September 1986. When this failed to stop below cost sales, the Reagan Administration imposed sanctions.

These remain in place in early 1990 on the issue of the lack of access to the Japanese market. Despite this relatively quick action, the only American firms in the merchant DRAM market today are TI, Micron, and Motorola.

Following the trade agreement, prices on the spot market rose sharply to as much as four to five times long-term contract prices. Further, prices charged to U.S. purchasers have typically been 30 percent higher than those for Japanese users. In sharp contrast, EPROM prices—where U.S. producers still have 40 percent of the world market and 70 percent of the U.S. market—have been much more disciplined.

Some analysts believe that Japanese producers, who now control the world DRAM market, have subsequently acted like a **cartel**²: driving prices up to capture excess

²Charles Ferguson, "DRAMs, Component Supplies, and the World Electronics Industry: An international Strategic Analysis," VLSI Memo 89-554, August 1989, Massachusetts Institute of Technology, Cambridge MA; Kenneth Flamm, "Policy and Politics in the International Semiconductor Industry," paper presented at SEMI ISS seminar, Newport Beach, CA, Jan. 16, 1989.

Figure D-2—Average Cost Per Bit for DRAMs, 1976-89

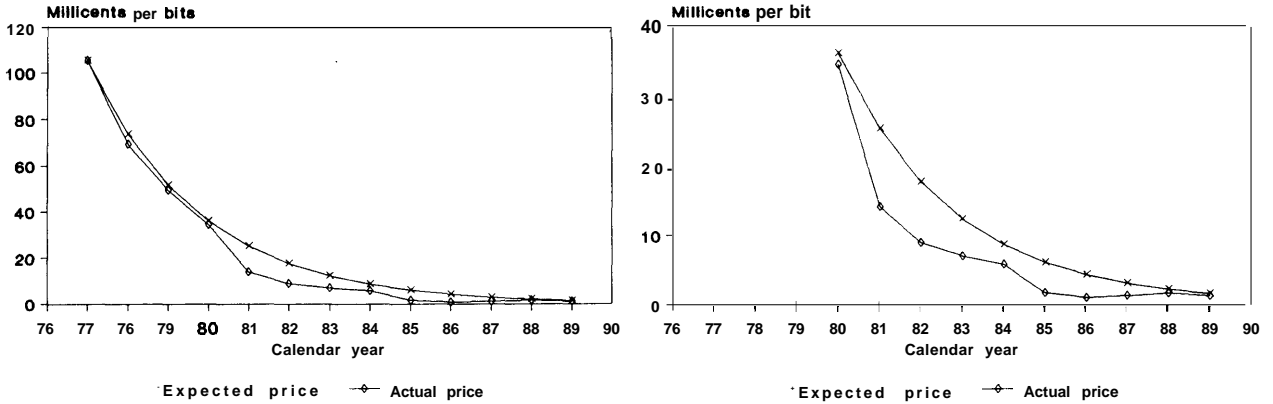

Showing the large price erosion that took place in 1981 and 1985.

SOURCE: Based on data in: "Mid-Term 1988," Integrated Circuit Engineering Corp., Scottsdale, AZ, 1988.

profits in 1988 and 1989, and driving prices down, as in fall 1989 to perhaps warn any would-be entrants into the DRAM market with the specter of enormous financial losses. The effort to launch U.S. Memories—a DRAM production consortium—was finally abandoned in Janu-

ary 1990, in part due to this sharp decline in DRAM prices; the same day, many of Japan's largest chip producers announced DRAM production cutbacks to turn the price declines **around**.³

³David E. Sanger, "Contrasts on chips," *New York Times*, Jan. 18, 1990.

The Development of the Japanese Computer Industry¹

Japanese researchers at the University of Tokyo, the **Electrotechnical** Laboratory (run by **MITI** after 1952), **NEC**, Fujitsu, **NTT** and elsewhere resumed pre-war work on computing machines in the late 1940s and early 1950s. The computers they developed were generally small, low-cost, and technically well-behind the better financed efforts in the west. In 1955, a **MITI-sponsored** committee recommended that **the** computer sector be given more financial support, be protected by limiting imports, and be assisted in the acquisition of foreign technology. The first test came the following year.

In 1956, IBM requested **MITI's** permission to create a wholly owned manufacturing subsidiary (it already had a sales subsidiary) in Japan with the right to return royalty payments and profits to its parent company. Permission was denied. A settlement was not reached until 1960, when IBM was allowed to establish its desired subsidiary and to repatriate 10 percent royalties back to its parent in return for licensing its patents to all interested Japanese companies for a 5-year period at a single reduced rate--5 percent on computer systems, and 1 percent on parts, among other concessions. **MITI** negotiated these licensing rights on behalf of the individual companies to prevent competitive bidding-up of the royalties and to prevent the establishment of a domestic monopoly.

Even with the 1960 settlement, IBM-Japan operations were closely controlled by the government on the grounds that it might hurt domestic industry. IBM-Japan was not allowed to begin production until 1963; its 1964 request to produce the 360 series was delayed for a full year--until after Fujitsu and **NEC** had introduced their own "family series"; its importation of critical parts which could not be produced locally was slowed; and the entry of capital that it needed to build facilities was restricted.

Beginning during this same period, the Japanese Government began an extraordinary series of initiatives to enable Japanese firms to become world class competitors in computer technologies and markets.

First, the Japanese Government provided domestic firms direct financial support. Subsidies and tax breaks totaled about \$130 million and loans totaled more than \$400 million during the 1960s. Together, this was nearly twice what domestic firms themselves invested in R&D,

plant, and equipment for commercial computer development.

That funding was often not used at the firms' discretion. Much of it went to **specific** investments that government, business, and university researchers agreed would contribute most to technical progress and production efficiency. Support was also **targetted** towards specific firms to develop certain classes of computers (Fujitsu, **NEC**, and Hitachi) and particular pieces of peripheral equipment (Oki, Mitsubishi, and Toshiba). This divided the market and improved the scale economies for the firms in each segment. Firms chosen by the government to lead the effort in **specific** segments varied over time on the basis of competitive proposals and past performance. For example, Hitachi was chosen to lead the 1966 Super High-Performance Computer **Project**--intended to develop a domestic counter to IBM's 360 Series--on the basis of its design proposal.

The government-backed Japan Electronic Computer Co. (**JECC**) was another important source of direct support. Most of its directors were former **MITI** or Japan Development Bank **officials**; and it was financed with low-interest loans either directly through the Japan Development **Bank**, or through a **MITI-organized** private financing cooperative with the loans guaranteed by the JDB. As of 1978, the **JECC** was the 20th largest firm in Japan in terms of capital; yet had no sales division, did not advertise, had just 120 employees, and averaged annual profits of less than 0.1 percent of rental assets.

The **JECC** (est. 1961) purchased computers at relatively high fixed values to prevent price competition and provide producers reasonable profits; and then rented them to users at values designed to undercut IBM. This gave computer makers their cash up front, and shifted much of the financial burden from the computer firms to the **JECC**. While 15 companies had licensed IBM's basic patents, only the top seven firms were allowed to enter **JECC** in order to prevent excessive competition such as "redundant investment and cut-throat pricing." The top three--Fujitsu, Hitachi, and **NEC**--were given preferential treatment. Following the establishment of the **JECC**, Japanese companies share of the domestic market jumped from 18 percent in 1961, to 33 percent in 1962,

¹Principal sources include: Marie **Anchordoguy**, "The State and the Market: Industrial Policy Towards Japan's Computer Industry," draft, 1986 and *Computers, Inc.* (Cambridge, MA: Harvard University Press, 1989); Jonah D. **Levy** and Richard J. **Samuels**, "Institutions and Innovation: Research Collaboration As Technology Strategy in Japan," MITJSTP 89-02, Massachusetts Institute of Technology, 1989; **Kenneth Flamm**, *Targeting the Computer: Government Support and International Competition, Creating the Computer: Government, Industry, and High Technology* (Washington, DC: Brookings Institution, 1988); **Robert Sobel**, *IBM vs. Japan: The Struggle for the Future* (Briarcliff Manor, NY: Stein & Day Publishers, 1986); Charles H. **Ferguson**, "Technological Development, Strategic Behavior, and Government Policy in Information Technology Industries," PhD. Thesis, Massachusetts Institute of Technology; **Ira C. Magaziner** and Thomas M. Hout, "Japanese Industrial Policy," Report #585 (London, England: Policy Studies Institute, 1980); "A Worldwide Strategy for the Computer Market," *Business Week*, Dec. 14, 1981; John **Markoff**, "Fujitsu Will Pay \$833.3 Million to IBM To Settle Software Fight," *New York Times*, Nov. 30, 1988.

to 52 percent in 1965 despite the technical inferiority of their computers.

The **JECC** only bought the specific machines that users ordered for rent and, further, required computer makers to buy back at book value any computers that users wished to trade in after the minimum 15 months. This forced the producers to compete for customers through continuously developing better computers. At the same time, domestic content requirements were only slowly increased. When these **buybacks** became excessive for computer companies, however, the government accelerated depreciation, further lowered the interest rate charged **JECC**, and allowed these companies to put money for trade-ins into tax-free reserves. By 1972, for example, some 60 percent of the cost of a computer could be depreciated in the first year.

Firms began developing their own rental systems in the early **1970s** to circumvent (undercut) **JECC's** price cartel and thus gain market share. Hitachi, for example, put some \$180 million into its rental system in 1973 alone, using profits from its consumer electronics division.

Second, the government organized cooperative R&D beginning in 1962. Cooperative R&D reduced the financial burden on individual firms, promoted the diffusion of critical technologies, and increased competition by preventing any one firm from gaining control of critical technologies. Many projects, including the first—the **FONTAC** project—fell far short of their goals. With each project, however, more was learned about managing such cooperative ventures, the R&D was done at a lower cost than if firms had each done it individually, and, with experience, better computers were developed. Projects which maintained a strong competitive environment between firms were generally more successful than those which placed all bets on a single horse.

The Japan Software Co., for example, was established in 1966 as a joint venture between Hitachi, **NEC**, Fujitsu and the Industrial Bank of Japan. It was intended to develop the software needed for the **MITI-organized** effort involving all of the Japanese computer firms to match the IBM 360 computer. It failed. The company presumed it had an assured market and made little effort to build up outside customers. Software technology is complex and abstract and realistic goals were difficult to formulate. The company was left with little direction. In addition, software technology changed rapidly and became increasingly important in overall system cost, increasing the desire of firms to keep software development within their own company rather than contracting for it outside. The presence of the Japan Software Co. also discouraged other firms from entering the software market. When the project ended in 1972, its orders dropped precipitously leading to bankruptcy and dissolution in December 1972.

Third, the government allowed firms to establish agreements with foreign partners for technological cooperation, while at the same time denying foreign firms (with the exception of IBM) direct entry into their market. Other firms had less market power and fewer patents to trade upon and were thus generally unable to get terms even as favorable as **IBM's**—**IBM** was the only computer firm to get a wholly owned subsidiary during the 1960s. Sperry Rand, for example, was able to enter the Japanese market only by accepting a minority interest in a joint venture with **Oki Electric**. Between 1961 and 1964, Hitachi, Mitsubishi, **NEC**, **Oki**, and Toshiba formed agreements with RCA, TRW, Honeywell, **Sperry Rand**, and GE respectively. This dependence on U.S. firms caused considerable turmoil in the **1970s** when firms such as RCA and GE abandoned their computer businesses.

Fourth, the government increased protection for the domestic computer industry. Tariffs on imported computers were raised from 15 percent to 25 percent in June 1960 and tariffs on computer peripherals were raised to 25 percent when the government decided to enter that market in the late 1960s. The tariffs on computers were lowered in 1964 when Japan entered **GATT** and the **OECD**. Quotas also limited imports, and were not ended until the early **1970s**. As already noted, IBM's production in Japan was similarly limited. Foreign firms, IBM in particular, were also excluded from certain data-processing markets which developed in the late 1960s by changing various laws that had restricted **NTT's** entry. This allowed **NTT** to begin a cooperative research project in 1968 to develop a large, high performance computer for on-line data processing and to subsequently provide these services and dominate this market. **NTT** has also been a major source of R&D funding as well as a major market for computer firms.

Fifth, government control over computer imports gave it strong leverage over firms applying for import licenses to instead buy a Japanese made-computer. These efforts were effective. Purchases of foreign computers (including those made in Japan) were reduced from 93 percent in 1958 to 43 percent in 1969 despite the technological inferiority of Japanese-made machines.

This "Buy Japan" policy did cause inefficiency and hardship, particularly in the 1960s when production was just getting underway and the technological gap was the largest. Firms objected to this pressure from **MITI** to buy domestic computers, usually unsuccessfully. The **government** allowed, however, the import of some foreign computers to prevent excessive damage to critical sectors and to push firms to do better by showing them the level of technology needed to compete in world markets.

Sixth, government procurement played an important role in Japan just as it had in the United States. In the

1960s, the Japanese Government purchased or rented 25 percent of all domestic computers.

These efforts helped. The U.S. hardware advantage was reduced **from** some 10 years in the mid-1960s to perhaps 4 years by the early **1970s**. The Japanese share of their domestic market increased to some 60 percent by 1970. The introduction of the IBM 370 in the early **1970s**, reduced the Japanese share of their domestic market to 48 percent in 1974. RCA, GE, and others **left** the market at this time due to the heavy investment that would have been required to remain even somewhat competitive with IBM.

Japanese producers might have left the market as well had it not been for government protection and support. Indeed, IBM had enormous advantages in the scale of its operations. In the late 1960s, the top three Japanese computer firms each manufactured about 2 percent of the number of computers made by IBM for any given type. At the same time, their currency was revalued, they were under increasing pressure from the United States to open their markets, and oil prices were crippling their heavy industries.

In response to IBM's 370 Series, the government organized the firms into three groups: Fujitsu and Hitachi focused on large computers; **NEC** and Toshiba on small and **midlevel** machines; and Mitsubishi and Oki on specialized scientific and industrial machines. From 1970-75, more than \$600 million in subsidies, including tax breaks, and over \$1 billion in low-interest loans helped these firms make the investments needed to compete with IBM. Indeed, these subsidies and loans totaled nearly 1.7 times what the firms themselves invested in R&D plant and equipment.

Similarly, the computer firms would have had to massively increase their debt in order to finance their computer sales directly rather than through the **JECC**. Fujitsu, for example, would have had to more than double its long-term loans during the 1960s, and then nearly triple them again in the **1970s**—**pushing** its debt-equity ratio to 21—in order to provide this financing itself.

A *major* opportunity also arose when a former top designer for IBM spun off a startup firm in 1970 to produce IBM compatible **mainframes**. Unable to secure sufficient funding, he turned to Fujitsu for help in 1972

and received \$54 million between 1972-76 in exchange for technical information. In 1974, Fujitsu announced it would produce computers in Japan for this company, **Amdahl**, to market in the United States. **Amdahl** is now 49 percent owned by Fujitsu and sells over \$1 billion of IBM-370 compatible mainframes annually.

The intensive internal effort and external technology acquisitions helped Japanese manufacturers produce computers competitive with the 370 series within 3 to 4 years of IBM's offering. When these machines became available beginning in the mid-1970s, Japanese users quickly began trading in their IBM systems for those of domestic producers. The number of IBM systems rented out actually declined for some models while the comparable Japanese offerings showed increasing usage.

The role of the Japanese Government continued to be important even after the market was officially opened in 1975. Direct subsidies totaled some \$1 billion between **1976-81**—**equal** to a quarter of private-sector investment in R&D, plant, and equipment. If low-interest loans are included, government support nearly equaled private sector investment during this period.

The Japanese computer firms have grown enormously in strength. They offer IBM compatible equipment that is **often** as good, sometimes even better, than IBM itself, and they are willing to drastically cut prices to capture market share. Hitachi, for example, has offered central banks, government agencies, and others discounts of 50 to 60 percent below **IBM** prices in order to win customers. These tactics have worked. Between 1975-85, Japanese computer exports increased 35 times, while imports only doubled.

World reliance on IBM-compatible hardware and software continues *to be* a serious weakness for Japanese **firms**—**one** which they have sometimes gone to great lengths to circumvent. In 1982, for example, an FBI sting operation caught Hitachi and Mitsubishi stealing IBM technology. Recently, Fujitsu was required to pay IBM nearly \$1 billion for its ongoing unauthorized use of IBM software. These and other incidents have led to Japan's current Fifth Generation, Supercomputer, and other projects which include the goal of ending their dependence on IBM-compatible software.

Appendix F

Research and Development Consortia¹

The scale of investment required to catch up with Japanese and European HDTV projects naturally leads to the consideration of R&D consortia. U.S. industry (and government) have traditionally viewed consortia as unnecessary (given a technological lead), inefficient, and possibly illegal (for antitrust reasons). But times change, and there are clear signs that the climate of opinion in the United States is changing. Many consortia have sprung up: industry-university consortia for basic research, like the Semiconductor Research Corp.; private sector consortia aimed at long-term basic research, like the Microelectronics & Computer Technology Corp. (MCC); and consortia aimed at developing manufacturing technology, notably **Sematech** and the National Center for Manufacturing Sciences (NCMS).

Aside from simple catchup, there are good reasons for this flowering of consortia in the United States. As manufacturing processes become more complex and technology more sophisticated, the cost of R&D is rising rapidly. Consortia offer a way of sharing these costs and risks, which are becoming increasingly difficult to bear. For example, Yasuro Matsukara, general manager of **NEC's VLSI division**,² said that it would have cost his firm five times as much to develop their electron-beam lithography system independently. In contrast, six U.S. semiconductor equipment manufacturers attempted to develop e-beam systems independently in the early 1980s. **Only Perkin-Elmer** succeeded, with the others eventually writing off losses of more than \$100 million and quitting the market.

There are other reasons why consortia may be useful and attractive. They can help to correct the well-known U.S. tendency toward short-term thinking and strategy.³ They may generate externalities not captured by an individual firm but available either to the economy or the industry—such as a source of competition for foreign monopoly suppliers of high-technology inputs.⁴ They can train people in methods and practices not prevalent in their home corporations. They may help to diffuse new technologies, especially where consortia are designed to help companies catch up in areas of technological weakness. Finally, they can help participants create

formal and informal ties and alliances which may be critical for international competitiveness and technology development.

Less tangible benefits of consortia may also be important. Some consortia may offer a forum for industry to discuss common problems and a framework for industry to quickly establish technical standards and common equipment interfaces.

Initiating cooperation among otherwise strongly competitive firms can be difficult. Strong firms may hesitate to join, fearing loss of their proprietary technologies with little to gain from weaker firms. In Japan, government support then plays an important role both symbolically and substantively in enabling such **collaboration**—reassuring strong firms that they will get back at least as much as they give.

Companies similarly fear the loss of their best personnel to a consortium and may consequently send their second-best. Admiral Bobby **Inman** initially rejected 95 percent of the researchers sent by member companies to the Microelectronics & Computer Technology Corp. (MCC—a private U.S. consortium formed in 1982). Firms are likewise reluctant to share their in-house ideas or technologies. IBM's and AT&T's donations of important leading-edge technologies to **Sematech** suggest how vital they view its mission.

All these elements may be achievable during the enthusiasm of starting up a new consortium, but maintaining them—especially once the high-level champions in the member firms have moved onto other problems—is a different and more difficult matter still. It is often hard for firms to agree on an R&D agenda or to maintain a long-term perspective. For example, managers are often forced to concentrate on the near-term bottom line within their firm, and therefore may in turn demand quick supporting results from a consortium—though its purpose is longer term R&D. When R&D is successful, it can still be difficult to transfer technologies from the consortium to the member firms, particularly when the firm has not maintained good in-house technical expertise. Finally, even if the member firms are confident that these barriers

¹Sources for this section include: Mark Eaton, "MITI and the Entrepreneurial State," unpublished monograph, MCC, Austin, TX; Jonah D. Levy and Richard J. Samuels, "Institutions and Innovation: Research Collaboration As Technology Strategy in Japan," and Richard J. Samuels, "Research Collaboration in Japan," MIT-Japan Science and Technology Program; George R. Heaton, Jr., "The Truth About Japan's Cooperative R&D," *NAS Issues in Science and Technology*, fall 1988; "Co-Operating to Compete," *The Economist*, Apr. 5, 1980, pp. 74-75; Charles H. Ferguson, "Technological Development, Strategic Behavior, and Government Policy in Information Technology Industries," Ph.D. Thesis, Massachusetts Institute of Technology, 1988; Lee Smith, "Can Consortia Defeat Japan?" *Fortune*, June 5, 1989; Sheridan Tatsumo, *The Technopolis Strategy* (New York, NY: Prentice-Hall, 1986); and interviews with personnel at the Semiconductor Research Corp., Research Triangle Park, NC; the Microelectronics & Computer Technology Corporation (MCC), Austin, TX; and **Sematech**, Austin, TX.

²Japan's semiconductor consortium, '90-1990

³For a discussion of the reasons behind this tendency, some of the most important of which are found in the U.S. financial environment, See, U.S. Congress, Office of Technology Assessment, *Making Things Better: Competing in Manufacturing*, OTA-ITE-443 (Washington, DC: U.S. Government Printing Office, February 1990).

⁴This was the aim of the U.S. Memories project, which failed in part because it aimed at generating externalities that might have gone uncaptured by the firms themselves.

can be overcome and that the consortium will be successful, in some cases they may have antitrust concerns to deal with.

Consortia pose potential risks as well—of being ineffective and wasting money; of reducing competition; or of hampering creativity. Cooperative long-term R&D also does not address the areas where U.S. firms have had the greatest **difficulties**—in manufacturing process and incremental product improvement.

Japanese consortia have provided many of these same benefits to member firms, and have suffered many of the same problems of initiating and sustaining cooperation. For example, judging itself to lead in the technology, Hitachi refused to collaborate in a \$60 million 8-year **MITI** sponsored R&D project to develop high-power CO₂ lasers for flexible manufacturing. **MITI** nevertheless helped fund Toshiba and Mitsubishi. Today, all three firms have comparable CO₂ laser technology and the level of **interfirm** competition has no-doubt accordingly increased. Some Japanese consortia have been abject failures as well. The Japan Software Co. (**app. E**) is an example.

Japan is famous for its consortia, and justifiably so. One-third of Japanese industrial R&D is collaborative. But these consortia take a form different from those usually used to describe consortia in the United States. Fully 90 percent of collaborations are between two firms only, usually in the same *keiretsu* (industrial grouping). Only 6 percent of Japanese industry R&D is done collaboratively between firms in the same business (i.e., direct competitors). Much of the research done within these consortia is also done on a partitioned rather than a collaborative basis, with the results being shared but the research being done by individual firms in their own labs. Fewer than 1 in 200 of Engineering Research Associations—

horizontal R&D consortia—have had joint laboratories. Such partitioned efforts have nevertheless been important in reducing duplication and the needed investment by any individual firm: Chapter 2 notes several examples of this for HDTV.

The critical element in the Japanese equation has been the role of **MITI**, not necessarily for providing the funding for collaborative R&D, but as a facilitator, supporter, and long-range voice. During the Japanese catch-up phase, **MITI** often negotiated for patent rights on behalf of **all** Japanese firms, and in many cases demanded patent rights as a condition for a foreign firm to have even a limited presence in the Japanese market. This kept patent licensing fees uniformly low for Japanese firms and provided all interested firms access to the **technology**—preventing any one from gaining monopoly control. In joint R&D efforts, partitioning research between firms allows the government to assign more difficult portions to stronger firms—effectively holding them back while implicitly aiding weaker firms. With **all** the participating firms having access to the same basic technologies by such mechanisms, competition is heightened and by necessity also moves downstream into manufacturing process—the area where U.S. firms have most lagged their competitors.

Simple emulation of the Japanese model is not possible or desirable in the U.S. environment. But as the European initiatives for science and technology show, there are many ways in which the positive attributes of the Japanese model can be captured in a different setting. It is likely, therefore, that the right consortia operating under the appropriate conditions can help U.S. industry in some critical sectors—perhaps including HDTV. The trick is to make sure that the circumstances and conditions are **right**.⁵

⁵A more detailed review of some of these issues can be found in OTA's report, *Making Things Better*, op. cit., footnote 3.

Appendix G

Acronyms and Glossary

Acronyms

- AEA** —*heLiCan* Electronics Association, table 2-3.
AM/LCD —Active Matrix Liquid Crystal Display
ANSI —**American National** Standards Institute, table 2-3.
ASIC —Application Specific Integrated Circuit
ATSC —Advanced Television Standards committee, table 2-3.
ATTC —**Advanced** Television Test Center, table 2-3.
ATV —Advanced Television
BTA —Broadcast Technology Association
CM'S —Center for Advanced Television Studies, table 2-3.
CCD —Charge-Coupled Device
CCIR —Comite **Consultatif** International des **Radiocommunications**
CD —Compact Disk
DARPA —Defense Advanced Research Projects Agency (**DoD**)
DAT —Digital Audio Tape
DBS —Direct Broadcast Satellite
DoD —U.S. Department of Defense
DRAM —Dynamic Random Access Memory
DSP —Digital Signal Processor
DVI —Digital Video Interactive
EBU —European Broadcasting Union
EDTV —Extended- or Enhanced-Definition Television
EIA —Electronic Industries Association, table 2-3.
EIAJ —Electronic Industries Association of Japan.
FCC —Federal Communications Commission
FSS —Fixed Satellite Services
GHz —Gigahertz
HD-MAC —High Definition Multiplexed Analog Component
HRs —High Resolution Systems
HDTV —High Definition Television
IC —Integrated Circuit.
IDTV —Improved Definition Television
IEEE —Institute of Electrical and Electronics Engineers, table 2-3.
ISDN —Integrated Services Digital Network
ITFS —Instructional Television Fixed Service
ITU —International Telecommunications Union
kHz —Kilohertz
LCD —Liquid Crystal Display
LPTV —**Low-Power** Television
MHz —Megahertz
MITI —The Japanese Ministry of International Trade and Industry
MSO —Multiple System Operator
MMDs —Multichannel Multipoint Distribution Service
MMT —Multi-media Terminals
MPAA —Motion Picture Association of America, table 2-3.
MPT —The Japanese Ministry of Posts and Telecommunications
MUSE —Multiple **sub-Nyquist** Sample Encoding
NAB —National Association of Broadcasters, table 2-3.
NCTA —**National Cable Television** Association, table 2-3.
NHK —Nippon Hoso **Kyokai** (Japan)
NTIA —National Telecommunications and Information Administration
NTSC —National Television Systems Committee
PAL —Phase Alternation by Line
SECAM —Sequential Encoded Color Amplitude Modulation
SMATV —Satellite Master Antenna Television
SMPTE —Society of Motion Picture and Television Engineers, table 2-3.
TVRO —Television Receive Only
UHF —Ultra High Frequency
VCR —Video Cassette Recorder
VHF —Very High Frequency
VHS —Video Home System
VRAM —Video Random Access Memory

Glossary

- 525/59.94; 625/50: The number of scan lines followed by the field rate for the existing NTSC (U. S., Japan, etc.), PAL (Europe except France, China, etc.), SECAM (France, Soviet Union, etc.) color TV systems.
1050/59.94; 1125/60; 1250/50: The number of scan lines followed by the field rate for various HDTV system proposals, corresponding to the United States, Japan, and Europe, respectively.
Active Matrix Liquid Crystal Display (AM/LCD): An advanced type of liquid crystal display.
Advanced Television (ATV): Refers generically to all the improvements in TV over today's system, including **IDTV**, **EDTV**, and **HDTV**.
Application Specific Integrated Circuit (ASIC): A type of integrated circuit produced in relatively limited numbers for a specific application.
Artifact: An audio or video error or defect introduced during the processing or transmission of a TV signal.
Aspect Ratio: the ratio of a screen's width to its height. Today's TVs have a **4:3 aspect** ratio. HDTV systems typically call for a **5:3** or **16:9** ratio.

- Bandwidth:** The range of frequencies available for or used to carry an electronic signal.
- Beta:** The first, but less popular, format for home VCRs.
- Bit Rate:** The rate at which digital data is carried or transmitted, measured in units of bits (binary digits) per second. This is the digital equivalent of an analog bandwidth.
- Broad Band:** A signal that requires a large bandwidth to be transmitted or equipment that must be capable of receiving and transmitting accurately a signal with a large bandwidth.
- Broadcast Technology Association (BTA):** An organization of private Japanese broadcasters and equipment manufacturers.
- C-Band:** The range of frequencies from 4 to 6 GHz. See figure 3-1.
- Cable TV Labs:** A lab setup by the NCTA to test cable systems, including those for ATV, table 2-3.
- Charge-Coupled Devices (CCD):** A type of solid-state electronic device used as a sensor in some types of cameras.
- ClearVision:** The Japanese EDTV system.
- Comite Consultatif International des Radiocommunications (CCIR):** An organization under the ITU which studies technical questions and issues recommendations for international radio matters.
- Compact Disk (CD):** An optical storage medium used for music and for computer data, among others.
- Compatibility:** The ability of one type of TV set to receive and display the signals designed for another TV system. See box 4-3.
- Digital Audio Tape (DAT):** A new technology that records music *on* magnetic tape in a digital format. DAT has many applications to computer data storage.
- Digital Signal Processor (DSP):** A type of digital chip that manipulates a video (in the case of HDTV) signal. For the purposes here, this manipulation is usually to either compress the signal so that it can be transmitted or decompress it and turn it back into a viewable picture.
- Digital Video Interactive (DVI):** A digital technology in which the viewer can interact with the image being shown. For example, a viewer might take a video “walk” through a building being designed by an architect and see the details of the interior or view the building from any desired angle, at that person’s discretion.
- Direct Broadcast Satellite (DBS):** It transmits TV signals directly to satellite receiver dishes at viewer’s homes. DBS is a high-power system that requires only small dishes.
- Downlink:** The transmission (or receiver system) from a satellite.
- Dynamic Random Access Memory (DRAM):** A computer memory chip. The capacity of DRAMs is measured in bits—1Kb (1,000 bits), 1Mb (1 million bits), etc. The storage capacity of a computer or other systems is measured in bytes—1 KB, 1MB, etc.—and one byte equals 8 bits.
- Eureka 95:** The joint project to develop ATV systems for Europe.
- European Broadcasting Union (EBU):** A union of European broadcast organizations whose purpose is, among others, to develop standards for the exchange of program material among its members.
- Extended- or Enhanced-Definition TV (EDTV):** A form of TV that provides a better picture than today’s TV or IDTV using today’s broadcasts, but somewhat less resolution than HDTV. EDTV requires modest changes in today’s NTSC broadcast signal, but is compatible with it while remaining within today’s channel bandwidths. EDTV usually has a greater than 4:3 aspect ratio.
- Federal Communications Commission (FCC):** The U.S. Government agency dealing with communications issues and allocation of the radio frequency spectrum.
- FCC Advisory Committee on Advanced Television Service:** The industry committee set up by the FCC to make recommendations on advanced television system broadcasting standards.
- Fiber:** Optical fibers used to carry information, usually in the form of pulses of light.
- Field:** The alternate lines that compose half of a complete television picture or frame. In the United States, fields are shown at a rate of 59.94 fields per second; in Europe, fields are shown at a rate of 50 fields per second.
- Fixed Satellite Services (FSS):** Satellites that are assigned geostationary orbits and provide information transmission services.
- Frame:** A complete television picture, including both even and odd alternating scans. The frame rate in the United States is 29.97 frames per second; in Europe, it is 25 frames per second. If frames are shown at too slow a rate, there can be an annoying flicker to the picture.
- Gigahertz (GHz):** One billion cycles per second.
- Headend:** A cable TV system’s control center where incoming signals from satellites and other sources are put on cables going to subscribers.
- Hertz (Hz):** Cycles per second. One kHz is 1,000 cycles per second; one MHz is 1 million cycles per second; one GHz is 1 billion cycles per second.
- High Definition Multiplexed Analog Component (HD-MAC):** The European HDTV system for DBS delivery.
- High Definition TV (HDTV):** Usually defined as having roughly twice the resolution of today’s TV systems, a wider aspect ratio of 5:3 or more, and compact disk quality sound.
- High Resolution Systems or High Definition Systems**

- (HRS): Information** systems that provide a high resolution visual image. See box 1-1 for examples.
- HiVision:** The Japanese HDTV system based on their MUSE standard.
- Improved Definition TV (IDTV):** A television that uses digital technologies to improve the picture seen even with today's conventional broadcasts.
- Instructional Television Fixed Service (ITFS):** A TV delivery service by line-of-sight microwave that the FCC licenses for use by educational institutions.
- Integrated Services Digital Network (ISDN):** A fully digital telephone network now being implemented. This system makes use of the existing copper wire infrastructure but adds improved electronics which allow much higher data rates to be carried.
- Interlaced Scan:** A technique which first shows all the even lines of the TV picture or frame, and then shows all the odd lines of the frame. Each set of lines corresponds to one field. This allows the picture to be shown without flicker while reducing the total bandwidth necessary to transmit the picture.
- International Telecommunications Union (ITU):** An intergovernmental organization with 164 member countries, whose purpose is to develop regulations and voluntary recommendations, provide coordination of telecommunication development, and foster technical assistance to developing countries. The CCIR is one of the organizations under the ITU.
- Kilohertz (kHz):** One thousand cycles per second
- Ku-Band:** The range of frequencies between 11 to 14 GHz. See figure 3-1.
- Liquid Crystal Display (LCD):** The type of display used on calculators and watches.
- Low-Power TV (LPTV):** Stations licensed by the FCC to use low transmitter power, usually in areas not locally served by full-power stations.
- Megahertz (MHz):** One million cycles per second.
- Multichannel Multipoint Distribution Service (MMDS):** A TV delivery system using line-of-sight microwave with four or more channels operated by a single company. MMDS is often called wireless cable' and is similar to ITFS in operation.
- Multi-media Terminals (MMT):** Computer terminals that can combine normal text and graphics with near-real-time video images or other forms of visual display.
- Multiple System Operator (MSO):** A company that operates more than one cable TV system.
- Multiplex:** See box 3-1.
- Multiple Sub-Nyquist Sampling Encoding (MUSE):** The bandwidth compression technique developed by Japan's NHK to allow delivery of an HDTV quality signal over a DBS system.
- National Telecommunications and Information Administration (NTIA):** A U.S. Government agency under the Department of Commerce.
- National Television Systems Committee (NTSC):** The industry group that defined the current U.S. B&W and then color TV standards. The NTSC system is used in the United States, Canada, Japan, and elsewhere.
- Nippon Hoso Kyokai (NHK):** The national radio and television broadcasting organization for Japan. Has extensively funded and coordinated HDTV development in Japan.
- Optical Disks:** Recording media including CDs that store information in patterns of microscopic pits on the surface of the disk, which can then be detected by a solid state laser and detector system and reproduced as sound, images, or data.
- Pay Per View:** Program services purchased by subscribers on a per-program rather than per-month basis
- Phase Alternation by Line (PAL):** The type of TV system used in most European countries (with the notable exception of France), The People's Republic of China, Australia, and elsewhere.
- Progressive Scan:** A TV picture that is shown in a single scan—the way we read a book—rather than by alternately sending all even and all odd Lines as for an interlaced scan.
- Resolution:** A measure of a picture's detail.
- Satellite Master Antenna Television (SMATV):** Or "private cable"; a miniature cable system that receives programming by satellite and serves a housing complex or hotel.
- Sequential Encoded Color Amplitude Modulation (SECAM):** The TV system used today in France, the Soviet Union, and elsewhere.
- Taboo Channel:** A TV channel left unused in order to prevent interference on adjacent active TV channels in the same geographic area.
- Television Receive Only (TVRO):** A satellite receiving antenna, also known as a downlink or a backyard dish.
- Transponder:** A satellite component that receives and retransmits a TV signal or perhaps many narrower-band data channels.
- Ultra High Frequency (UHF):** The band including TV channels 14 through 83. See figure 3-1.
- Uplink:** The transmission or corresponding equipment to a satellite for relay.
- Very High Frequency (VHF):** The band including TV channels 2-13, which are more powerful than UHF channels. See figure 3-1.
- Video Cassette Recorder (VCR):** Piece of equipment used for recording and replaying TV broadcasts or prerecorded video material at home.
- Video Home System (VHS):** The most common format for today's VCRs.
- Video Random Access Memory (VRAM):** A type of memory chip similar to a DRAM, that is optimized for high-speed handling of video images.