

*Healthy Children: Investing in the Future*

February 1988

NTIS order #PB88-178454

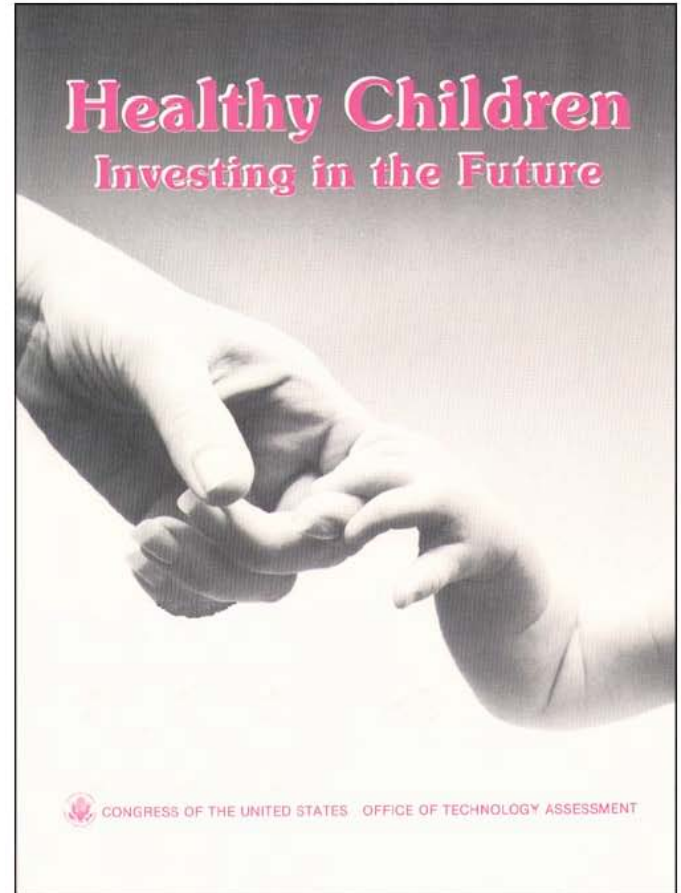

Recommended Citation:

U.S. Congress, Office of Technology Assessment, *Healthy Children: Investing in the Future*, OTA-H-345 (Washington, DC: U.S. Government Printing Office, February 1988).

Library of Congress Catalog Card Number 87-619858

For sale by the Superintendent of Documents  
U.S. Government Printing Office, Washington, DC 20402-9325  
(order form can be found in the back of this report)

## Foreword

Infants and young children are among America's most vulnerable citizens; they are utterly dependent on their families and communities for the resources required to live and grow into healthy and productive adults. Health care for young children must be viewed as an investment with potential payoffs that will extend throughout their lifetimes. Like all investments, those made for children's health care should be channeled into directions that can most efficiently improve children's health.

OTA was asked by the House Energy and Commerce Committee and its Subcommittee on Health and the Environment and the Senate Labor and Human Resources Committee to examine the effectiveness and costs of selected strategies for promoting and maintaining the health of children and to identify strategies whose implementation could substantially improve children's health or lower health care costs. The Committees also wanted to know why the infant mortality rate in the United States does not appear to be declining as fast as it has in the past and whether children have access to the care they need. The Senate Finance Committee asked OTA to examine the evidence on the effectiveness and costs of ambulatory tocodynamometry, a new prenatal care technology for monitoring pregnant women at high risk of premature labor.

This OTA assessment addresses all of those issues. Two related reports have already been issued as part of this study. An OTA technical memorandum, *Technology-Dependent Children: Hospital v. Home Care*, was released in May 1987 in response to specific questions about this group of children with special health care needs. OTA also prepared a case study, *Neonatal Intensive Care for Low Birthweight Infants: Costs and Effectiveness*, in December 1987 that examines the most recent data on this costly but life-saving treatment for low birthweight newborns.

This assessment was ably assisted by an advisory panel, chaired by Harvey Fineberg, Dean of the Harvard School of Public Health. In addition, many individuals from academia, the Federal Government, the private sector, and the public provided information and reviewed a draft of the assessment. The final responsibility for the content of the assessment rests with OTA. Key staff involved in the analysis and writing were Judith Wagner, David Alberts, Marvin Feuerberg, Elicia Herz, Kerry Kemp, Julia Ostrowsky, and Elaine Power.



JOHN H. GIBBONS  
*Director*

## Advisory Panel on Technology and Children's Health

Harvey Fineberg, *Chairman*  
Harvard School of Public Health  
Boston, MA

LuAnne Aday  
Center for Hospital Administration Studies  
University of Chicago  
Chicago, IL

Julianne Beckett  
Child Health Specialty Clinic  
University of Iowa  
Iowa City, Iowa

Donald Berwick  
Quality of Care Measurements  
Harvard Community Health Plan  
Boston, MA

Alexander Capron  
Medicine and Public Policy  
University of Southern California  
Los Angeles, CA

Norman Fost  
Program on Medical Ethics  
Department of Pediatrics  
University of Wisconsin Hospital  
Madison, WI

Robert Goldenberg  
Department of Obstetrics and Gynecology  
University of Alabama  
Birmingham, AL

Michael Grossman  
Health Economics Research  
National Bureau of Economic Research  
New York, NY

Robert Haggerty  
W.T. Grant Foundation  
New York, NY

Patricia King  
Georgetown Law Center  
Washington, DC

Phyllis Leppert  
Director of Perinatal Research  
St. Lukes/Roosevelt Hospital Center  
Columbia University  
New York, NY

Harvey Levy  
IEM-PKU Program, Children's Hospital  
Boston, MA

Edward Lis  
Division of Services for Crippled Children  
University of Illinois  
Chicago, IL

Joanne Macon  
Holman Health Region  
Chicago Department of Health  
Chicago, IL

John MacQueen  
Child Health Specialty Clinic  
University of Iowa  
Iowa City, IA

Janet Reis  
School of Nursing/SUNY Buffalo  
Buffalo, NY

Sarah Rosenbaum  
Children's Defense Fund  
Washington, DC

Barbara Starfield  
Division of Health Policy  
Johns Hopkins University  
School of Hygiene and Public Health  
Baltimore, MD

NOTE: OTA gratefully acknowledges the members of this advisory panel for their valuable assistance and thoughtful advice. The panel does not, however, necessarily approve, disapprove, or endorse this report. OTA assumes full responsibility for the report and the accuracy of its contents.

# OTA Project Staff—Healthy Children: Investing in the Future

Roger C. Herdman, *Assistant Director, OTA  
Health and Life Sciences Division*

Clyde J. Behney, *Health Program Manager*

Judith L. Wagner, *Project Director*

David W. Alberts, *Research Analyst*

Pony M. Ehrenhaft, *Senior Analyst*

Marvin A. Feuerberg, *Analyst*

Elicia J. Herz, *Analyst*

Kerry B. Kemp, *Division Editor/Analyst*

Julia T. Ostrowsky, *Analyst*

Elaine J. Power, *Analyst*

## **Other Contributors**

Sarah M. Dry, *Research Assistant*

Brigitte M. Duffy, *Research Assistant*

Hellen Gelband, *Senior Analyst*

Mary Ann Hughes, *Research Analyst*

Pamela J. Simerly, *Analyst*

## **Administrative**

Virginia H. Cwalina, *Administrative Assistant*

Carol Ann Guntow, *P.C. Specialist*

Karen T. Davis, *Secretary/Word Processor Specialist*

Carolyn D. Martin, *Clerical Assistant*

## **Contributing Contractors**

Martha Burt, *The Urban Institute*

Howard Dubowitz, *Washington, DC*

Isaac Eberstein and Robert Weller, *Tallahassee, FL*

Harriette Fox, *Washington, DC*

Charles Homer, *Massachusetts General Hospital*

John Iglehart, *Potomac, MD*

Michael Kenney, *Pinole, CA*

Lorraine Klerman and Helen Burst, *Yale University*

Peter McMenamin, *Chevy Chase, MD*

Bonnie Preston, *Takoma Park, MD*

Leon Robertson, *Branford, CT*

T. Paul Schultz, *Yale University*

Katherine Swartz, *The Urban Institute*

## List of Related OTA Reports

- Background Paper:
  - Children's Mental Health: Problems and Services.*  
OTA-BP-H-33, December, 1986, GPO stock #052-003-01040-2, NTIS order #87-207 486/AS.
- Technical Memorandum:
  - Technology-Dependent Children: Hospital v. Home Care.*  
OTA-TM-H-38, May 1987, GPO stock #052-003-01065-8.
- Case Study:
  - Neonatal Intensive Care for Low Birthweight Infants: Costs and Effectiveness.*  
OTA-HCS-38, December 1987, GPO stock #052-003-01089-5.

NOTE: Reports are available through the U.S. Government Printing Office, Superintendent of Documents, Washington, DC 20402-9325, (202) 783-3238; and the National Technical Information Service, 5285 Port Royal Road, Springfield, VA 22161-0001, (703)487-4650.

# Contents

<i>Chapter</i>	<i>Page</i>
1. Summary and Policy Options . . . . .	3
Part I: Overview of Children's Health	
2. Children's Health Status: Current Trends . . . . .	31
3. Children's Access to Health Care . . . . .	53
Part 11: Prevention of Childhood Illness—Selected Topics	
4. Prenatal Care . . . . .	73
5. Newborn Screening . . . . .	93
6. Well-Child Care . . . . .	119
7. Prevention of Accidental Childhood Injuries . . . . .	147
8. Prevention of Child Maltreatment . . . . .	167
<i>Appendix</i>	<i>Page</i>
A. Method of the Study . . . . .	189
B. Acknowledgments . . . . .	191
C. U.S. Infant, Neonatal, and Postneonatal Mortality Rates . . . . .	195
D. OTA's Derivation of the Estimate of the Population of Children Without Health Insurance . . . . .	197
E. Physician Participation in Medicaid . . . . .	198
F. Ambulatory Tocodynamometry . . . . .	202
G. Background Information on Prenatal Care . . . . .	212
H. Disorders Currently Detected by Newborn Screening . . . . .	231
I. Data and Methods Used in OTA's Cost-Effectiveness Analysis of Strategies for Newborn Screening . . . . .	236
J. Effectiveness of Well-Child Care and Cost-Effectiveness of Childhood Immunization . . . . .	242
K. Current National Data Sources on Accidental Injuries . . . . .	256
L. Preventing Unintended Pregnancies in High-Risk Women: School-Based Clinics . . . . .	258
M. Glossary of Abbreviations and Terms . . . . .	261
References . . . . .	271

---

Chapter 1

# Summary and Policy Options



# CONTENTS

	<i>Page</i>
Introduction .....	3
Study Boundaries .....	4
Trends in U.S. Infant Mortality .....	4
Preventing Low Birthweight .....	8
prenatal care .....	8
Comprehensive School-Based Clinics for Teenagers .....	10
Preventing Health Problems in Early Childhood .....	11
Newborn Screening for Congenital Disorders .....	11
Well-Child Care... ..	13
Preventing Accidental Childhood Injuries .....	14
Preventing Child Maltreatment .....	16
Improving Children's Access to Effective Health Services .....	17
Conclusions .....	19
Options for Federal Policy .....	19
Expanding Access to Prenatal Care for Poor Women .....	19
Encouraging the Development of Comprehensive School-Based Clinics for Adolescents .....	20
Promoting Effective Newborn Screening Programs .....	21
Encouraging Appropriate Well-Child Care... ..	22
Encouraging the Use of Child Safety Restraints in Automobiles .....	23
Encouraging the Development of Nurse Home Visitor Programs .....	23
Improving Poor Children's Access to Physicians' Care .....	24

## Tables

<i>Table No.</i>	<i>Page</i>
I-1. Burden of Illness in U.S. Children .....	5
I-2. Net Incremental Health Care Costs of a Low Birthweight Birth .....	9
I-3. Incremental Effectiveness and Health Care Costs of Six Expanded Newborn Screening Strategies Compared to a Basic One-Specimen, Two-Test Strategy ...	13

## Figures

<i>Figure No.</i>	<i>Page</i>
I-I. U.S. Infant Mortality Rates by Race, 1968-85 .....	6
I-2. U.S. Children's Medical Visits: Mean Number of Visits by Family Income, 1980 .....	17

# Summary and Policy Options

## INTRODUCTION

A nation's future lies with its children. Thus, the health of children is a matter of fundamental importance to all societies. In highly industrialized countries like the United States, the vast majority of children are healthy,<sup>1</sup> but preventing disease and reducing injuries among the young holds promise for even further improvements in their well-being.

Substantial improvements in children's health have been registered in the United States within the recent past. The U.S. infant mortality rate, for example, declined from 14.1 per 1,000 live births in 1977 to 10.8 in 1984, and the mortality rate of children between 1 and 14 years declined from 42.3 per 1,000 in 1977 to 34.1 per 1,000 in 1984.

Without dismissing the importance of such gains, one can cite at least three compelling reasons for an assessment of strategies for further improving American children's health. First, the evidence suggests that the United States is not doing as well as it could in preventing health problems in children, despite the improvements to date. Second, prevention or treatment of health care problems in early childhood can benefit a child for a lifetime, and, conversely, failure to prevent such problems can be costly to the child, the child's family, and the Nation. Finally, the burdens of illness, disability, and death are not borne evenly. Some American children are at particularly high risk for poor health, and many of them have only limited access to medical services.

The high cost of poor health in infants and children suggests that some preventive strategies, even those approaches that are initially expensive,



Photo credit: March of Dimes Birth Defects Foundation

Prevention or treatment of health care problems in infancy or early childhood creates a lifetime of benefits for the child, the child's family, and society.

may have payoffs in improved health, lower medical care costs, or both, that make them well worth their expense. The principal objective of this OTA assessment was to identify preventive strategies with high payoffs in relation to their initial costs.

<sup>1</sup>As used in this assessment, health refers to physical, not emotional or mental health. As many as 12 to 15 percent of the Nation's children may suffer from mental or emotional problems. For a discussion of issues involving children's mental health, see OTA's back-ground paper *Children's Mental Health: Problems and Services* (663)

<sup>2</sup>A preventive strategy is any action taken by individuals, professionals, or government to alter the environment, change the be-

havior of a child or the family, or provide effective health care with the intention of preventing disease or injury (364). A strategy includes not only specific preventive technologies (e. g., vaccines or childproof safety caps for medicines) but also the means of financing, organizing, and delivering such technologies (e. g., mandatory school immunization programs)

## STUDY BOUNDARIES

Given the wide range of potential issues in children's health, boundaries were needed for OTA's study. OTA focused on preventive strategies applicable to preadolescent children, because the major health problems of adolescence have their origins in emotional and behavioral problems rather than in problems of physical health.

Furthermore, the assessment focused largely on strategies involving personal health care services, not on strategies involving, for example, the educational sector or the larger environment in which children are raised. Some authorities claim that American children's health problems can be effectively addressed only in the context of a comprehensive national strategy that considers the implications of changes in the structure of the American family, the increasing percentage of mothers who work outside the home, and the increasing percentage of children in poverty (248,396,639). Although a good case can be made for a comprehensive national strategy on children, and some elements of such a strategy are already in place, there is still good reason to search for more limited actions that can be implemented and that can benefit children today.

This assessment of preventive strategies placed heavy emphasis on the importance of reducing the

U.S. infant mortality rate, which is almost double the rate in Japan and higher than the rates in 15 other developed countries (733). One of the primary causes of infant mortality is low birthweight (under 2,500 grams or 5 lbs. 8 oz.). Two personal health care strategies for preventing low birthweight are examined in this assessment:

- providing better access to family planning services for high-risk women, particularly adolescents; and
- improving prenatal care for pregnant women at high risk of giving birth to low birthweight babies.

OTA also focused on four other health problems of young children:

- congenital disorders detectable by newborn screening techniques;
- diseases and conditions preventable through well-child care;
- accidental injuries; and
- maltreatment (child abuse and neglect).

Each of these health problems accounts for a substantial burden of illness, disability, and death in U.S. children. Table 1-1 summarizes some pertinent facts about each area chosen for study.

## TRENDS IN U.S. INFANT MORTALITY

Infant mortality is a matter of widespread concern in this country. The infant mortality rate for any year is defined as the number of infant deaths under 1 year of age per 1,000 live births in the same year. About 1 percent of all babies born in the United States—40,030 in 1985—die in the first year of life (709). Almost two-thirds of these infant deaths occur in the neonatal period (the first 28 days of life); the others occur in the postneonatal period (28 days to 1 year).

The infant mortality rate has long been a primary indicator of the overall health status of nations for two reasons. First, it tends to be closely associated with access to food, shelter, education, sanitation, and health care; and second, it is rela-

tively easy to monitor with basic vital statistics collected in most countries.

The United States ranks 17th among industrialized countries in infant mortality, and its position has not improved since 1980 (733). If the U.S. infant mortality rate in 1985 had been equal to that achieved by the country with the lowest rate (Japan, with a rate of 5.5 deaths per 1,000 live births in 1985), there would have been 19,350 fewer infant deaths in the United States that year—a sum greater than the number of deaths of all U.S. children 1 to 15 years of age in 1985.

The high U.S. infant mortality rate is brought about largely by the high low birthweight rate in this country. Low birthweight so overwhelms

Table 1-1.—Burden of Illness in U.S. Children

Problem	Burden of illness or cost
Infant mortality and low birthweight	<ul style="list-style-type: none"> <li>• Almost 40,000 babies (1 percent of all U.S. births) die in the first year of life each year.</li> <li>• The United States ranks 17th among industrialized countries in infant mortality.</li> <li>• 6.7 percent of all U.S. newborns are low birthweight babies (under 2,500 grams, about 5 lbs. 8 oz.).</li> <li>• 16 percent of all very low birthweight babies (i.e., those weighing under 1,500 grams, about 3 lbs. 5 oz.) are moderately or severely handicapped.</li> </ul>
Congenital disorders detectable by newborn screening	<ul style="list-style-type: none"> <li>• About 4,500 cases of detectable diseases causing death or mental retardation occur each year.</li> </ul>
Conditions preventable through well-child care	<ul style="list-style-type: none"> <li>• 37 percent of U.S. infants were fully immunized against diphtheria, tetanus, and pertussis (whooping cough) in 1983.</li> <li>• 78 percent of white children and 62 percent of nonwhite children from 1 to 4 years old were fully immunized against polio in 1985.</li> <li>• Almost 8,000 cases of measles occurred in the United States in 1986.</li> </ul>
Accidental childhood injuries	<ul style="list-style-type: none"> <li>• 7,850 deaths were caused by accidental injuries in children under 15 years old in 1984.</li> <li>• 1 in every 9 children is hospitalized for accidental or other injuries before age 15.</li> <li>• 10 million emergency room visits per year are made for accidental or other injuries.</li> </ul>
Child maltreatment	<ul style="list-style-type: none"> <li>• At least 1,200 children's deaths in 1986 occurred as a result of child abuse.</li> <li>• 24,000 children sustained serious physical injury due to child abuse in 1983.</li> <li>• 1.9 million cases of suspected child abuse and neglect were reported in 1985.</li> <li>• 150,000 to 200,000 cases of sexual abuse occur in the United States each year.</li> </ul>

SOURCE: Office of Technology Assessment, 1988

other health problems of early childhood that it cannot be ignored. The prevention of low birthweight and infant mortality has been a recent concern of many groups in this country (296,604); in 1979, the U.S. Surgeon General's Report on Health Promotion identified the reduction of infant mortality as a fundamental goal of the Nation (715).

Until the early 1980s, the United States made remarkable progress in reducing infant mortality. During the 17-year period from 1968 to 1985, the U.S. infant mortality rate declined by about 50 percent for both whites and blacks—from 21.8 deaths per 1,000 live births in 1968 to 10.6 per 1,000 births in 1985 (see figure 1-1). The average annual compound rate of decline during this period was 4.2 percent. The infant mortality rate for blacks remained equal to about twice the white rate throughout the 17-year period.

In the early 1980s, the pace of the decline in the U.S. infant mortality rate slowed apprecia-

bly. In the 3-year period from 1981 to 1984, the annual average of rate of decline was 3.3 percent, down by about 20 percent from the 4.1-percent average experienced in the 4-year period from 1977 to 1981. And provisional U.S. infant mortality data extending into 1987 indicate continued deterioration in the pace of decline.

Year-to-year fluctuations in reported infant mortality rates are to be expected, but the recent slowdown in improvement of the U.S. infant mortality rate cannot be dismissed as a random variation around the trend. At OTA's request, the National Center for Health Statistics (NCHS) predicted U.S. infant mortality rates for the 3-year period from 1982 to 1985 on the basis of trends in final U.S. infant mortality rates from 1968 to 1981. The U.S. infant mortality rate in 1985 was 10.6 infant deaths per 1,000 live births, significantly higher than the rate predicted for that year on the basis of the NCHS analysis (9.9 deaths per 1,000 births). Had the U.S. infant mortality rate

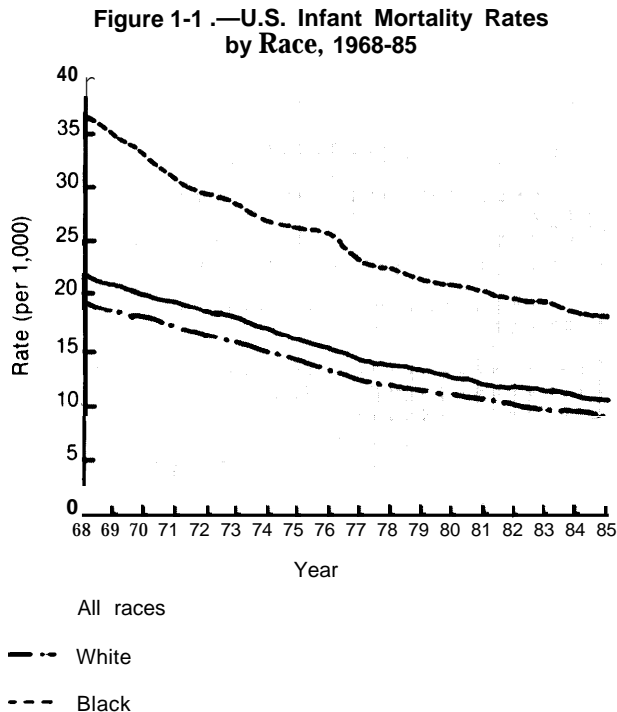

SOURCE Office of Technology Assessment, 1988, based on U.S. Department of Health and Human Services, Public Health Service, National Center for Health Statistics, Hyattsville, MD, unpublished data from U.S. vital statistics, 1986

continued to decline after 1981 at the rate predicted by NCHS on the basis of previous trends, the United States would have suffered about 2,630 fewer infant deaths in 1985 than were actually reported.

No single explanation is sufficient for why the U.S. infant mortality rate began to level off in the early 1980s and continues to do so into the present. But the key to the slowdown puzzle appears to be the deteriorating U.S. birthweight distribution—especially the increase in the number of live births recorded in the lowest birthweight categories. In 1980, low birthweight infants represented less than 7 percent of all newborns in the United States but accounted for 60 percent of all babies who died in infancy (687).

Progress in reducing infant mortality rates can come through two routes:

1. changes in birthweight-specific infant mortality rates, and
2. changes in the distribution of birthweights toward heavier babies.

Historically, most of the progress in the United States since 1960 has been via the first route. In fact, between 1960 and 1980, about 91 percent of the improvement in the U.S. infant mortality rate was due to changes in birthweight-specific mortality rates (80). In recent years, U.S. birthweight-specific mortality rates have continued to improve, in large measure as a result of rapid advances in the technology of neonatal intensive care (665). Neonatal intensive care units (NICUs) offer sophisticated monitoring and therapy to premature infants whose undeveloped lungs do not function properly. The 1970s saw rapid advances in respiratory therapy techniques and improvements in mechanical ventilation, which had a major impact on the survival of premature infants with respiratory distress syndrome. In the 1980s, continued improvements in outcomes have occurred in very low birthweight infants (those under 1,500 grams or 3 lbs. 5 oz.), with the greatest improvement in the 750- to 1,000-gram birthweight group (665).

While U.S. birthweight-specific mortality rates have improved in the 1980s, the reported birthweight distribution in this country has actually deteriorated. Between 1977 and 1984, the percentage of live births at normal birthweights (greater than 2,500 grams) increased slightly, but the distribution of low birthweight infants shifted toward the lowest birthweight intervals (those under 1,000 grams or 2 lbs. 3 oz.). Had U.S. birthweight-specific mortality rates not improved in this period, the deteriorating birthweight distribution would have resulted in an *increase* in the overall U.S. infant mortality rate (339).

Ironically, the success of NICUs in improving outcomes of the larger very low birthweight babies may be partly responsible for the reported deterioration of the birthweight distribution. As the frontier of viability has been pushed back to smaller and smaller babies, obstetricians and neonatologists may be more frequently resuscitating the very tiniest newborns, even those under 500 grams, despite the fact that very few of these infants will survive. The increased concentration of high-risk births in sophisticated regional perinatal centers and ethical concerns arising from the

“Baby Doe” controversy may also be contributing to higher rates of resuscitation.

In addition to more aggressively resuscitating the tiniest newborns, U.S. hospitals today may be more careful to report as live births what in the past might have been reported as fetal deaths or have gone unreported altogether. Greater awareness of State birth reporting requirements and legal and economic considerations may be influencing reporting practices (210,755).

Whatever the reasons, the number of reported live births under 500 grams in this country increased much more rapidly in the 1980s than did live births at all other birthweights (699,704,709). The vast majority of newborns under 500 grams die in infancy; thus, an increase in the reported number of live births in this category would have the effect of pushing up U.S. infant mortality rates.

In fact, OTA calculated that if the number of live births under 500 grams had increased between 1977 and 1984 only as fast as the number in the other low birthweight categories, the U.S. infant mortality rate in 1984 would have been 10.4 rather than the reported rate of 10.8 per 1,000 live births.<sup>7</sup> The slowdown in the rate of change in U.S. infant mortality would have been much less apparent without the excess births in the under-500-gram category: the average annual rate of decline in U.S. infant mortality rate would have been 4.4 percent (rather than the reported rate of 4.1 percent) from 1977 to 1981 and 4.1 percent (rather than the reported rate of 3.3 percent) from 1981 to 1984. Thus, a large part of the slowdown in improvement in the U.S. infant mortality rate in the early 1980s may be a reflection of changing management and reporting of very premature deliveries rather than a real deterioration in the health of pregnant women.

<sup>7</sup>Following the birth of Baby Jane Doe (an infant born with multiple birth defects) Federal regulations were written to require that hospitals treat severely handicapped infants over the objections of their parents. Those regulations were later declared unconstitutional by the Supreme Court.

<sup>8</sup>OTA assumed for this analysis that all under-500-gram live births died in infancy. Only a few such babies have survived to date.

Other factors may also have contributed to the slowdown in improvement, although available evidence suggests that their impact would be modest. Such factors include the natural maturation of technologies for neonatal intensive care that diffused widely in the mid-1970s and that are now improving outcomes of the smallest birthweight babies; the completion of the process of diffusion of abortion services in the late 1970s that may have differentially reduced birth rates in women at high risk for infant mortality, such as very young teenagers and unmarried women (610); the increase in the percentage of infants living in poverty; and deterioration in real dollars in the availability of subsidized health care services for pregnant women and children.

The coincidence of increasing poverty among infants in the early 1980s and decreased real spending on publicly subsidized health services in this country is particularly disturbing. From 1978 to 1984, the percentage of infants residing in poor families rose from about 18 to 24 percent. During this period, Medicaid expenditures in constant dollars per child recipient declined by 13 percent (278) and Federal funding for three important sources of primary health care for poor women and children—maternal and child health services, community health centers, and migrant health centers—declined in constant dollars by 32 percent (40,117,394).

Together, these trends suggest that more pregnant women and infants encountered severe financial obstacles to obtaining timely health care services in the early 1980s than in the late 1970s. Any resulting deprivation would be expected to have only a modest effect on the overall U.S. infant mortality rate, because relatively few women and infants would have been newly affected by the poverty and cutbacks and infant mortality is still a rare event. Yet, for a particular infant, being born to a mother in poverty with limited access to prenatal and infant care substantially raises the risk of dying in the first year. Thus, cutting back on funding for health care services at the same time that infant poverty rates in this country were increasing raised the risks of infant mortality for these babies.

## PREVENTING LOW BIRTHWEIGHT

The United States invests a great deal in the treatment of low birthweight babies and realizes considerable success. Neonatal intensive care has played a major and definitive role in the improved survival of low birthweight and premature infants since its introduction in the 1960s.<sup>5</sup> Each year, about 150,000 to 200,000 infants (from 4 to 6 percent of all U.S. newborns) are admitted to NICUs. At least one-half of these infants are low birthweight babies. Without question, neonatal intensive care is effective and becoming more effective over time. In 1960, 72 percent of all very low birthweight infants (1,500 grams or less) born in hospitals with sophisticated NICUs died in the first 28 days of life; by the early 1970s, the percentage had dropped to 54, and by the early 1980s, it had declined to 27 percent (665).

Although NICU care is effective, it is **also expensive**, ranking among the most costly of all hospital care. The effort to reduce the dependence of low birthweight babies on this expensive technology adds urgency to the search for strategies to prevent the need for NICU care in the first place.

### Prenatal Care

Prenatal care encompasses a wide range of preventive, diagnostic, and therapeutic services delivered throughout the course of pregnancy, with the goal of both a healthy baby and a healthy mother. Preventive components of prenatal care include screening for potentially harmful conditions in the mother and fetus, education and counseling, and sometimes nutritional supplements. Diagnostic and therapeutic interventions represent responses to and followup of problems identified either through symptoms or screening.

Because prenatal care includes not only preventive interventions such as screening and counseling but also treatment when needed, it is bound to be effective in altering the health of some mothers and infants. Treatment of gestational diabetes or hemolytic disorders, for example, is crit-

<sup>5</sup>For detailed information on the effectiveness and costs of neonatal intensive care, see OTA's 1987 case study *Neonatal Intensive Care for Low Birthweight Infants: Costs and Effectiveness* (665).



Photo credit: Yale University and March of Dimes Birth Defects Foundation

Questions remain about exactly which preventive measures in prenatal care are effective and at what intervals in the course of a normal pregnancy they are most effectively applied. Ultrasound examination is not currently recommended by the American College of Obstetricians and Gynecologists for routine use during pregnancy.

ical to healthy outcomes for both mother and infant. The real question of effectiveness is not whether prenatal care makes any difference to child health, but exactly which preventive measures—monitoring, screening, education and counseling, or nutritional supplements—are effective and at what intervals in the course of a normal pregnancy they are most effectively applied.

Various new techniques of prenatal care are being developed, and evidence needs to be gathered to ensure their appropriate use in the care of pregnant women. One technique for which evidence is only now accumulating, for example, is called “ambulatory tocodynamometry.” Its place in monitoring women at high risk for premature delivery is still undetermined.

### Effectiveness

The earlier that prenatal care is initiated, the more frequent the number of scheduled visits, and the more screening procedures that are performed, the more expensive prenatal care becomes. If frequent routine visits and procedures do not offer any advantages in terms of lowering risks of premature labor, allowing more effective treatment

or better management of labor and delivery than does seeking care when symptoms develop, the value of such preventive care would be dubious.

OTA examined the evidence on the effectiveness of early initiation of and more frequent prenatal care visits in reducing the rate of low birthweight and neonatal mortality. Despite serious shortcomings in almost all studies of prenatal care, the weight of the evidence from more than 55 studies of the effectiveness of earlier, more frequent, or enriched prenatal care services supports the contention that two key birth outcomes—low birthweight and neonatal mortality—can be improved with earlier and more comprehensive prenatal care, especially in high-risk groups such as adolescents and poor women. Although the evidence clearly supports the effectiveness of prenatal care, it is less revealing about the size of the effect that should be expected from increasing the quality or quantity of prenatal care received by any segment of the population.

#### Cost-Effectiveness of Expanded Prenatal Care for Poor Women

If prenatal care can improve birth outcomes, the logical next question is whether a specific strategy to increase access to effective services is worth its costs. The Omnibus Budget Reconciliation Act of 1986 (Public Law 99-509) gave States the authority to make a new group of previously ineligible pregnant women eligible for Medicaid—those whose incomes fall above the State's standards for Aid to Families With Dependent Children (AFDC) but below the Federal poverty level. Since April 1987, States have had the option of selecting any income standard for extending Medicaid eligibility to pregnant women, provided the standard is below the Federal poverty line.<sup>7</sup> By January 1988, 26 States had exercised their option to expand Medicaid eligibility to include more pregnant women in poverty.

**OTA performed a cost-effectiveness analysis to determine how costs to the U.S. health care system (not just to Medicaid) would be affected by**

<sup>7</sup>The Omnibus Budget Reconciliation Act of 1987 (OBRA-87) passed by Congress in December 1987 (Public Law 100-203) gave States even greater freedom to expand eligibility for Medicaid to pregnant women with incomes up to 185 percent of the Federal poverty line.

a policy of universal eligibility for Medicaid of all pregnant women in poverty. Under such a policy, approximately 194,000 pregnant women would be newly eligible for Medicaid coverage, but almost 60 percent of these women already have some form of private health insurance coverage. Overall, OTA estimated that offering Medicaid eligibility to all pregnant women in poverty would cause an additional 18.5 percent of women in this category to initiate early prenatal care (i. e., care in the first trimester of pregnancy). Nationally, the extra prenatal care would cost about \$4 million per year.<sup>7</sup>

**OTA estimated that for every low birthweight birth averted by earlier or more frequent prenatal care, the U.S. health care system saves between \$14,000 and \$30,000 in newborn hospitalization, rehospitalization in the first year, and long-term health care costs associated with low birthweight (see table 1-2).**

How effective would earlier prenatal care have to be for the extra prenatal care costs among newly eligible women—estimated at \$4 million—to be outweighed by the societal savings resulting from a reduction in the rate of low birth-

<sup>7</sup>Note that these extra costs of prenatal care *do not* represent the additional costs to Medicaid of providing eligibility, nor do they represent the full costs of prenatal care for the newly eligible women. They represent the additional costs associated with the new care initiated as a result of enhanced eligibility. The extra costs to Medicaid might be much higher, since Medicaid would probably be paying for care that previously had been paid for by patients and their families or been donated by other government agencies, providers, or philanthropic groups.

**Table 1-2.—Net Incremental Health Care Costs of a Low Birthweight Birth**

	Low-cost estimate	High-cost estimate
Initial hospitalization cost:		
• Hospital costs . . . . .	\$ 3,763	\$ 5,236
• Physician costs . . . . .	475	1,487
Total . . . . .	\$ 4,238	\$6,723
Rehospitalization costs in first year (hospital costs only) . . . . .	\$ 802	\$ 802
Long-term costs of treating low birthweight . . . . .	\$ 9,000	\$23,000
Total net incremental costs . . . . .	\$14,040	\$30,525

SOURCE: Office of Technology Assessment 1988



weight? OTA estimated that the expansion of eligibility for prenatal care benefits under Medicaid would have to prevent between 133 and 286 low birthweight births among the 194,000 new eligibles for the societal health care savings to outweigh the costs. If these women began with a low birthweight rate of 10.2 percent,<sup>8</sup> the low birthweight rate in the target population would have to decline by between 0.07 and 0.20 percentage points for health care costs to break even.

The reduction in low birthweight births would be concentrated in the group of poor women whose use of prenatal care changed as a result of the expanded eligibility for Medicaid. Among these new users, the low birthweight rate would have to decline by between 0.4 and 0.8 percentage points to between 9.4 and 9.8 percent.

Is it reasonable to expect reductions of this magnitude in the low birthweight rate? The evidence on the impact of earlier prenatal care on birthweight suggests that such reductions are quite feasible. The quantitative results of several reasonably well-designed studies of the effect of earlier prenatal care on birthweight showed effects that were at least twice as great as the effects required for the expansion of Medicaid eligibility to pay for itself in reduced health care costs (149,311,569, 600). That early prenatal care can also be expected to prevent some infant deaths (though the number cannot be predicted with certainty) further enhances the strategy's cost-effectiveness. Encouraging poor women to obtain early prenatal care through expanded Medicaid benefits is a good investment for the Nation.

### **Comprehensive School-Based Clinics for Teenagers**

One approach to reducing the U.S. infant mortality rate and low birthweight would be to give women at high risk of poor birth outcomes better opportunities to avoid unintended pregnancies (296). Teenagers and women age 35 and above have a higher risk than other women of having babies that die in the first 28 days of life and that weigh 2,500 grams (5 lbs. 8 oz. ) or less

<sup>8</sup>The low birthweight rate is defined as the percentage of live births with a birthweight of less than 2,500 grams.

at birth.<sup>9</sup> Similarly, women who have not graduated from high school are at greater risk of experiencing these poor birth outcomes than women with at least a high school education.

In 1984, over 1 million teenagers in the United States became pregnant. About 40 percent of these pregnancies ended in abortion and 13 percent ended in miscarriage (443), so the number of births to teenage mothers in this country in 1984 was about 470,000 (443). The vast majority of teenage pregnancies are not only unintended but unwanted once they occur. In 1979, 82 percent of unmarried teenagers who became pregnant in the United States reported that the pregnancy was unwanted, but of unmarried teenagers who did not want their pregnancy, only 32 percent used contraception (443).

Strategies for preventing teenage pregnancy span a wide range of philosophies, from programs that are intended to influence teenagers' attitudes about sexual behavior and relationships to programs that prescribe or dispense contraceptive services (443,652a). There is tentative evidence that comprehensive school-based clinics that offer contraceptive services (as well as other kinds of health care) can lower teenage pregnancy rates and avoid unwanted births. Not all school-based clinics located in high schools and junior high schools offer family planning services. Of those that do, only a few actually dispense contraceptives. Some clinics prescribe contraceptives, and many others refer students to other providers.

The effectiveness of school-based clinics in preventing pregnancies and births among adolescents has been examined at two programs to date, one with three sites in St. Paul, Minnesota (147,333), and the other located in Baltimore, Maryland (777). Studies of the St. Paul school-based clinic program suggested that the program was successful in reducing birth rates among female students (147,333). The Baltimore school-based clinic program appears to have prevented pregnancies and reduced levels of sexual activity among students receiving services (777).

<sup>9</sup>Except for very young teenagers (those under 15 years of age), the relationship between age and neonatal mortality is a reflection of other factors, such as poverty, poor health care, or risky behaviors, that tend to cluster in adolescent mothers.

Although it is premature to draw conclusions about the effectiveness of school-based clinics in reducing high-risk unwanted pregnancies in adolescents, the evidence accumulated to date does look promising. The costs of providing comprehensive school-based health services is about \$125

per year per student (443). As more evidence on the effectiveness of school-based clinics in reducing rates of teenage pregnancies and births accumulates, study of whether such clinics can yield net savings to the U.S. health care system will be warranted.

## PREVENTING HEALTH PROBLEMS IN EARLY CHILDHOOD

Once a baby is born, various preventive strategies are available to promote his or her health during infancy and beyond. OTA assessed the effectiveness or cost-effectiveness of interventions in four general categories: newborn screening for congenital disorders, well-child care, prevention of accidental injuries, and prevention of child maltreatment.

### Newborn Screening for Congenital Disorders

The screening of large populations of newborns for congenital disorders began as a public health activity in 1961 with screening for phenylketonuria (PKU). PKU, an inherited disorder of metabolism, occurs in about 1 in 10,000 to 1 in 15,000 infants. The development of a newborn screening test permitted its detection in the first week of life, so that treatment could begin before 2 to 4 weeks of age, thus avoiding the irreversible mental retardation that would otherwise occur.

Today, newborn screening for PKU and congenital hypothyroidism is conducted in all 50 States and the District of Columbia. Tests for various other congenital disorders are also offered in some States, including tests for homocystinuria, galactosemia, maple syrup urine disease, sickle-cell anemia, cystic fibrosis, biotinidase deficiency, and congenital adrenal hyperplasia.

In general, the disorders included in routine newborn screening programs are diseases that are present throughout the life of an affected individual, do not get better (and often worsen) with time, and can result in severe mental retardation, physical disabilities, and even sudden death if untreated in the first days or weeks after birth. Al-

though only a few disorders are in this category, and those are relatively rare, newborn screening followed by early and sustained treatment can make the crucial difference in affected infants.

#### Effectiveness

The effectiveness of newborn screening in identifying affected infants depends in part on the accuracy of the test itself; it also depends on the ability of the screening program to collect blood specimens from all infants and to perform the tests properly and in time to initiate treatment. Thus, the organization and management of newborn screening services, the timing and number of newborn blood specimens, and laboratory performance have major bearing on the effectiveness of newborn screening.

The United States and Canada are the only developed countries offering newborn screening that do not have a national screening program. In the absence of a national newborn screening program or national set of minimum standards, each State has taken a slightly different approach to providing screening services. A few States have joined with neighboring States to form regional programs (279). Most States have their own newborn screening programs; State programs usually do have a centralized screening laboratory, but many do not have an organized program of services linking the laboratory with followup, treatment, and monitoring. A few States operate without a central laboratory or a centrally organized program. These States rely on an informal network of individual families, physicians, and a combination of public and private laboratories to provide screening and followup.

In some areas, the lack of a coordinated network of newborn screening services may reduce

the overall effectiveness of newborn screening by putting infants at risk for not being screened or for not receiving appropriate treatment. There are no national data on the number of infants at risk, however, because there is no central system for collecting comprehensive data with which to monitor and compare the outcomes of newborn screening in the State and regional programs.

#### Cost-Effectiveness of Newborn Screening

Although the value of newborn testing in the hospital for PKU and congenital hypothyroidism is now widely accepted, there is substantial question about the appropriateness of testing for other conditions and about the need for a routine second blood specimen at around the third week of life to pick up cases that might have been missed on the first screen. The second specimen issue has gained importance in recent years as the trend toward early hospital discharge of newborns has increased the probability that some affected infants will be missed. (In 1985, about 42 percent of all newborns were discharged before 3 days, up from 31 percent in 1980, and the optimal age for PKU testing is 3 to 5 days after birth.) Concern over the adequacy of the test in blood specimens taken within 24 hours of birth (282,283,409) led the American Academy of Pediatrics (AAP) Committee on Genetics to recommend that all infants whose first sample was collected before 24 hours after birth have a second blood sample taken by the third week of life.

OTA performed a cost-effectiveness analysis comparing a basic screening strategy—one specimen taken in the hospital to test for PKU and congenital hypothyroidism—to no screening and to six expanded strategies. The six expanded strategies involve a second specimen or additional tests on a single specimen.

Newborn screening for PKU and congenital hypothyroidism using one specimen reflects the minimum situation common to all U.S. newborn screening programs. Compared to no screening, this basic screening strategy not only saves many infants (about 1,291 per year) from lifetimes of severe disability but also yields net savings for the U.S. health care system of about \$120 million per year. Each of the six expanded screening strate-

gies would save more babies from deadly or disabling diseases than the basic strategy (ranging from 50 to 160 infants nationwide per year, depending on the strategy), but the incremental costs of achieving those extra successes are high (see table 1-3).

The net health care costs per case detected by any of the expanded newborn screening strategies remain high even under the “best case” assumptions applied in a sensitivity analysis. OTA found, however, that under the best case assumptions, the cost of detecting an extra case via an expanded one-specimen strategy—to test for PKU, congenital hypothyroidism, galactosemia, and maple syrup urine disease—is about \$85,000. This amount would buy an entire lifetime for a child with one of these disorders and is low compared to the cost of many therapies currently considered accepted medical procedure. The cost (in 1986 dollars) per year of life gained from heart transplantation for congestive heart failure, for example, is about \$28,000 (162) to \$40,000 (98), and for a year gained from hemodialysis for end-stage renal disease is about \$36,500 (530).

Four congenital disorders not included in the screening strategies examined in OTA’s cost-effectiveness analysis—sickle cell anemia, cystic fibrosis, biotinidase deficiency, and congenital adrenal hyperplasia—are being considered for inclusion in an increasing number of newborn screening programs. Newborn screening for sickle cell anemia, in particular, is gaining widespread support as a result of recent evidence linking early detection and treatment of the disease with reduced mortality in the first few years of life (198).

OTA did not evaluate tests for these four disorders in its cost-effectiveness analysis, because reliable data on the long-term value of screening for these disorders do not exist. Few evaluations of the sensitivity and specificity of the screening tests and of the long-term value of early detection and treatment of sickle cell anemia, cystic fibrosis, biotinidase deficiency, or congenital adrenal hyperplasia have been conducted. In the absence of more data on effectiveness, estimates of the cost of screening and treatment, not to mention costs averted by screening, would be incomplete at best.

**Table 1-3.— Incremental Effectiveness and Health Care Costs of Six Expanded Newborn Screening Strategies Compared to a Basic One-Specimen, Two-Test Strategy<sup>a</sup> (1986 dollars)**

Expanded strategy	Number of extra cases detected in the United States	Net incremental cost per extra case detected and treated
Two specimens: on first specimen, test for PKU and CH; on second specimen, repeat test for PKU and CH in all infants . . . .	75	\$466,000
Two specimens: on first specimen, test for PKU and CH; on second specimen, test for PKU and CH only in infants with first specimen collected less than 72 hours after birth . . . . .	49	\$253,000
Two specimens: on first specimen, test for PKU and CH; on second specimen, test for CH only in all infants . . . . .	64	\$432,000
Two specimens: on first specimen, test for PKU and CH; on second specimen, test for PKU, CH, and HC in all infants . . . . .	94	\$421,000
One specimen: test for PKU, CH, GA, and MSUD . . . . .	68	\$173,000
Two specimens: on first specimen, test for PKU, CH, GA, and MSUD; on second specimen, test for PKU, CH, and HC in all infants . . . . .	162	\$317,000

Abbreviations PKU phenylketonuria; CH = congenital hypothyroidism; HC = homocystinuria; GA = galactosemia; MSUD = maple syru D urine disease  
<sup>a</sup>The basic newborn screening strategy to which the expanded strategies in this table are compared is a one-specimen Strategy with tests for phenylketonuria (p KU) and congenital hypothyroidism (CH)

SOURCE Office of Technology Assessment 1988

## Well-Child Care

Well-child care refers to a variety of preventive health services offered by physicians or other health professionals at defined points in a child's life, beginning as early as the second or third week after birth and extending into adulthood (227). The goal of well-child care is ultimately to improve the physical, cognitive, and psychological health of children both in childhood and adulthood.

Well-child care encompasses two main aspects of prevention:

- immunization; and
- health supervision, consisting of physical examinations and other tests that screen for illness or developmental problems, health education, and parental guidance.

### Immunization

Immunization provides the starkest example of the power of prevention to save or prolong lives, prevent significant disability, and lower medical care costs. It represents the ideal of medical progress—prevention rather than cure or relief of symptoms (642). Today, children in the United States are routinely vaccinated against eight dis-

eases: diphtheria, tetanus, pertussis (whooping cough), polio, measles, mumps, rubella (German measles), and, most recently, *Haemophilus influenzae b* (Hib).

The cost-effectiveness of the childhood vaccines is well established in the literature—indeed, such vaccines not only confer medical benefits but are cost-saving. The diphtheria, tetanus, and pertussis (DTP) vaccine—the most controversial vaccine—continues to be cost-saving, despite a rapid rise in vaccine prices due to the recent vaccine liability crises. As vaccine prices increase, however, costs saved with childhood immunization programs diminish. Thus, developments with regard to the current vaccine liability crisis will have an impact on whether childhood immunizations continue to be cost-saving.

New technologies on the horizon also will have an impact on the cost-effectiveness of childhood immunizations. Two new DTP vaccines developed by the U.S. National Institutes of Health and Japanese researchers could substantially reduce the number and seriousness of adverse reactions to the pertussis component of the DTP vaccine. A reduction in adverse reactions could decrease the amount of corresponding litigation and ultimately reduce vaccine prices.



Photo credit: Children Hospital National Medical Center

Well-child care comprises physical examinations and tests that screen for illness or developmental problems, immunization against polio and other diseases, health education, and counseling of a child's parents.

### Health Supervision

Evidence on the effectiveness of components of well-child care other than immunization is more remarkable for its limitations than for its findings. No evidence supports the contention that well-child care other than immunization significantly influences mortality or morbidity among children or that it enhances the development of a child's social competence. On the other hand, sample sizes have been uniformly too small and followup too brief to identify mortality changes; the available measures of childhood morbidity have been inadequate, and most investigators have not even looked at children's developmental outcomes. The

particular importance of the outcome measures examined to date and their duration of impact have not been evaluated. For these reasons, expert opinion and good intentions rather than scientific data currently guide the provision of well-child care. Participation in well-child care does seem to provide substantial satisfaction to both parents and providers, and the value of their satisfaction should not be overlooked.

Of the components of well-child care examined by OTA, childhood immunization for eight diseases is the only one shown to be cost-effective and cost-saving. A schedule of well-child care visits that corresponds to the AAP's and Immunization Practices Advisory Committee's recommended schedule for childhood immunization, therefore, is cost-saving. Such a schedule would include seven well-child care visits for normal infants and children in the first 6 years of life. The schedule for well-child care visits recommended by AAP calls for 13 visits in the first 6 years of life. Whether more well-child care visits than the seven required for childhood immunizations would be cost-effective is unknown, because researchers have yet to be able to document the effectiveness of the health supervision aspects of well-child care in terms of improved health outcomes. In formulating recommended schedules for well-child care visits, AAP and other recommending bodies have relied on expert opinion regarding the effectiveness of the components of well-child care other than immunization (284).

### Preventing Accidental Childhood Injuries

Accidental injuries are the leading cause of death in American children after the first few months of life.<sup>10</sup> In 1984, 7,850 U.S. children under age 15 died as a result of such injuries (713). Nationally, approximately 353,000 hospitalizations and nearly 10 million emergency treatments

<sup>10</sup>To describe accidental injuries, many people prefer the label "unintentional injuries" because they believe that the term "accidental" implies unavailability. OTA has chosen to use the term accidental injuries for two reasons. One is that it is the term more commonly used by the general public. The other is that many researchers in the field of child abuse argue that the term unintentional injuries does not in fact exclude all injuries due to child abuse, because some child abuse is unintentional.

annually are due to childhood injuries. Approximately 4,700 children under age 17 experience bed-disabling injuries each year (705).

Childhood accidents are very costly to American society, even after the tremendous social and emotional costs of death and disability are excluded. NCHS estimated that in 1980, injuries and poisonings (accidental and nonaccidental) accounted for 13.3 percent of acute medical care costs for U.S. children under age 17, or nearly \$2 billion (479). Most of this cost, which does not include long-term care costs or nonmedical costs, is probably due to accidental injuries. As a group, accidental and other injuries are the leading cause of potential years of life lost before age 65 (685). In infants under age 1, injuries are the second leading cause of death (after death due to conditions present at birth); and in all other children under age 15, they are the leading cause of death (451).

In 1984, the greatest number (43 percent) of the accidental fatalities in children under age 15 resulted from vehicle-related accidents. Drowning and fires/burns were also prominent causes of death among children in this age group.

There are three broad strategies for preventing accidental childhood injuries:

- *Persuasion/education*: persuading people to increase their self-protection (e. g., through education or reminders to use seatbelts).
- *Regulation of behavior*: requiring people to increase their self-protection (e. g., by passing laws requiring the use of seatbelts).
- *Automatic protection*: providing automatic protection from injury through product or environmental design (e. g., by designing automobiles so that a person is automatically seatbelted when in the vehicle) (451,531).

For motor-vehicle-related injuries in children, both regulation and automatic protection have been very effective in reducing deaths (and, presumably, serious injuries as well). In 1977, Tennessee passed the first State law requiring children to be restrained in an infant or child seat. By 1984, all 50 States had enacted laws requiring the use of safety restraints for children in automobiles (29). These laws contributed to the 36-percent de-

cline in motor-vehicle occupant deaths among children under age 5 between 1980 and 1984 (234,713).

Still, there is considerable room for improving child safety restraint laws. Many States require safety restraints in automobiles only for very young children. Altogether, 38 States have no restraint requirements for children over age 5 (and many States do not require restraints for children over 3 or 4) (719). Laws covering only certain ages and exempting certain vehicles may fail to prevent a substantial number of avoidable deaths. One analysis of motor-vehicle occupant fatalities in very young children (ages 0 to 5) concluded that in some States, up to 43 percent of deaths occurred in children who would not have been covered under restraint laws as of 1984 (636).

The evidence regarding the role of enforcement in improving the effectiveness of safety restraint use is somewhat conflicting. A few studies of specific enforcement efforts have found that such efforts had little additional effect (535). One study of seatbelt use found, however, that Texas had the highest rate of compliance in the Nation, a rate which Texas authorities attributed to vigorous enforcement efforts (518).

Automatic protection has also played an important role in the reduction of motor-vehicle-related childhood injuries. Attempts to reduce automobile injuries have included both product and environmental changes. The Motor Vehicle Safety Act of 1966 (Public Law 89-563) required automakers to include certain safety features in 1968 and subsequent model cars, such as shoulder belts, energy-absorbing steering assemblies, and interior padding. Reductions in automobile-associated deaths observed into the 1980s can probably be attributed in part to the continued attrition of old vehicles that did not meet the standards. The effect of the standards on death rates of children alone has not been estimated.

Other possibilities for improvement also remain. For example, many vehicles still have protrusions such as knobs and tapered dashboards that can cause injury to the faces, heads, and chests of individuals during crashes or sudden braking (752). One study found that 12 percent

of children's injuries in motor vehicles occurred in noncrash braking or swerving (4).

Although education programs designed to encourage families to use child safety restraints in automobiles have met with only modest success (522,523), education may be an important component of regulatory strategies, both in encouraging the legislative process and as a necessary background to acceptance and proper use of required technologies (177).

For accidental childhood injuries not involving motor vehicles, similar conclusions can be drawn. Automatic protection is most effective and regulation is often effective in reducing accidental injury rates, especially when accompanied by educational campaigns. Examples of actions that could together substantially reduce children's deaths due to accidental injuries include:

- helmets for bicyclists,
- barriers around swimming pools,
- universal use of smoke detectors,
- window bars in windows above the first floor,
- hot water heater temperatures of no more than 120 degrees Fahrenheit,
- stringent limits on the sales and use of all-terrain vehicles, and
- "no-right-turn-on-red" laws,

It must be remembered, however, that many of these preventive interventions involve additional costs to society or substantial loss of personal choice, issues that need to be taken into account when considering accident prevention policies.

## Preventing Child Maltreatment

Child maltreatment—including physical, psychological, and sexual abuse and neglect—is an especially troubling children's health problem because it is caused primarily by adult behavior, not by accidents or natural disease processes. In the past two decades, there has been an explosion of concern in professional and lay communities about the problem, but policy debates regarding appropriate responses are hindered by the lack of consensus about what constitutes maltreatment, what causes it, how frequently it occurs, and, most important, how it can be prevented.

All 50 States and the District of Columbia have laws defining child maltreatment and mandating that professionals working with children report suspected cases. Typically these laws are vague, leaving a good deal open to interpretation. State child protection agencies, which are designated by law to respond to reports of alleged child maltreatment, typically have a higher threshold for identifying a case as abuse or neglect than health care professionals have (143). For example, a pediatrician might consider corporal punishment of a child to be abusive and decide to counsel a child's parents about alternative disciplinary strategies. A social worker for a State child protective service agency, on the other hand, might require scattered bruising to substantiate a case report.

The lack of clear definitions of child maltreatment complicates attempts to estimate the frequency with which maltreatment occurs, but even clear definitions would not make measurement of the size of the problem easy. The unacceptability of child maltreatment and its potential legal consequences makes conventional methods of estimating incidence and prevalence (e. g., population-based surveys or incident reporting) unreliable. The more serious the maltreatment, however, the more likely are reporting systems to identify incidents. In 1985, 1.9 million cases of child maltreatment were reported to child protective services agencies in the United States (657). A 1986 survey of child protection agencies estimated that at least 1,200 children died of child abuse in that year (448).

Few child maltreatment prevention programs have been rigorously evaluated to ascertain their short-term and long-term outcomes. Between 1979 and 1981, the National Center on Child Abuse and Neglect (NCCAN) sponsored a national evaluation by Berkeley Planning Associates of 19 NCCAN-funded clinical demonstration projects (56). The 19 federally funded projects were intended to demonstrate the effects of specialized clinical treatments in five abuse and neglect subpopulations (sexual abuse, adolescent maltreatment, substance-abuse-related maltreatment, child neglect, and remedial services to maltreated children). The evaluation methodology was critically flawed, lacking in comparison groups or in ob-

rates of participation, and their participation rates increased slightly in the period between 1978 and 1984. The increase may be due to factors unrelated to payment, in particular, the increase in the supply of pediatricians during the period. Despite these trends, continued stringency in Medicaid payment rates can only put more pressure on children's access to private physicians in the future.

## CONCLUSIONS

Fortunately, most children in the United States enjoy excellent health, but this assessment demonstrates that greater strides toward improvement in their well-being are still possible if more emphasis is placed on cost-effective prevention strategies. As the same time, a reality must be recognized in any effort to employ such strategies. Every inch of ground gained is won with greater

difficulty and usually at higher costs than the last because the remaining problems, by definition, are more intractable. It is the familiar phenomenon of diminishing returns, with one vital difference: virtually no new gain can be dismissed as unimportant if it promises some real reduction of infant mortality and other forms of suffering.

## OPTIONS FOR FEDERAL POLICY

OTA has identified several preventive strategies for improving American children's health, some of which would be clearly cost-saving to the U.S. health care system, some of which are effective (though not cost-saving), and some of which hold promise of having important impacts on children's health:

- . improved access to early prenatal care for poor women (cost-saving);
- comprehensive school-based clinics for adolescents at high risk of unwanted pregnancy (promising);
- newborn screening using a single blood specimen to identify four congenital disorders (PKU, congenital hypothyroidism, maple syrup urine disease, and galactosemia) (effective);
- . well-child care as often as required for full immunization of young children (seven visits in first 6 years of life) (cost-saving);
- . use of child safety restraints in automobiles (effective, probably cost-saving);
- . nurse home visitor programs for pregnant

women and infants in families potentially at high risk for low birthweight, childhood accidents, or child maltreatment (promising); and

- improved access to physicians' services for children living at or near the poverty level (effective).

Specific policies for bringing about these improvements are discussed below.

### Expanding Access to Prenatal Care for Poor Women

Option 1: Congress could mandate that eligibility for Medicaid be extended to all pregnant women with incomes below the Federal poverty line.

In the Omnibus Budget Reconciliation Act passed in December 1987 (OBRA-87) (Public Law 100-203), Congress gave States the power to extend Medicaid coverage to pregnant women with family incomes up to 185 percent of the Federal



poverty line.<sup>12</sup> States vary widely in Medicaid eligibility and benefit standards, however, and there is no reason to think that the variation will be reduced under a program in which participation is voluntary. So far, only 26 States have elected to expand Medicaid benefits to all pregnant women in poverty. States may be reluctant to undertake responsibility for a new eligibility group, because expanding Medicaid to pregnant women in poverty will increase Medicaid costs as Medicaid pays for prenatal care that formerly was paid for by other State programs with more Federal matching dollars (e.g., the Maternal and Child Health services block grant), paid for by the patients' families, or provided by physicians and hospitals without compensation.

Requiring Medicaid coverage of all women with incomes below the poverty line would ensure equity in eligibility for Medicaid across the States. This option would raise Medicaid costs, although it could free some Maternal and Child Health services (MCH) block grant money to be used for other health needs of children and pregnant women. In States reluctant to implement this option, its effectiveness could be undermined through enrollment procedures that delay or make difficult the determination of Medicaid eligibility.

**Option 2:** Congress could require States to shorten the period for determining Medicaid eligibility for pregnant women and could direct the Federal Medicaid authorities to promulgate simplified eligibility forms and procedures for such women.

In some States, pregnant women who are eligible for Medicaid find it difficult to receive early prenatal care because of delays in the Medicaid enrollment process. States have 45 days to process an application for Medicaid, but women may encounter additional delays when their applications are incomplete or when other problems arise. Congress could require States to make Medicaid eligibility determinations for pregnant women a priority and to require less documentation for approval.

<sup>12</sup> The 1987 Federal poverty level is \$11,203 for a family of four (382).



*Photo credit: March of Dimes Birth Defects Foundation*

Early prenatal care can reduce the incidence of low birthweight and the high costs of neonatal intensive care.

Some providers have been reluctant to offer care to pregnant women in anticipation of their eligibility for Medicaid because of the fear of retroactive denial of eligibility and nonpayment for the services rendered (185). Under OBRA-86 (Public Law 99-509), a "qualified provider" can provide services to a woman presumed to be eligible and be guaranteed Medicaid reimbursement for that care even if eligibility is ultimately denied. Qualified providers include health departments, hospitals, and clinics, but not private physicians' practices. Thus, the presumptive eligibility clause of OBRA-86 appears to channel pregnant women who are probably eligible for Medicaid into sources of prenatal care other than private physicians. Relaxing the definition of a "qualified provider" would assure private physicians of some Medicaid reimbursement even if a woman's eligibility for Medicaid is ultimately denied; thus, this change would encourage private physicians to accept poor women for prenatal care.

### **Encouraging the Development of Comprehensive School-Based Clinics for Adolescents**

**Option 3:** The Federal Medicaid program could direct the States to expand funding for comprehensive school-based health clinics through Medicaid and its Early and Periodic Screening, Diagnosis, and Treatment (EPSDT) program.

jective measures of effectiveness. Consequently, this evaluation provides little information regarding the usefulness of the approaches undertaken by the demonstration programs,

The use of home health visitors to families at high-risk for child maltreatment has been studied more than any other preventive approach. Five programs, each of which provided a wide array of services to clients including visits in the home, have been evaluated (33,34,225,391,471,586). Although the specific home care services differed among the studies, four of the five studies found that home care services were effective in reducing actual rates of child maltreatment.

Taken together, available evaluations of home health visitor programs suggest that such pro-

grams may be successful in preventing child abuse and neglect.<sup>11</sup> Although it is difficult to specify at this point what program elements are most important in producing the positive outcomes, the home visitor model appears to have a number of practical advantages that enhance its effectiveness, including reaching parents who lack self-confidence and trust in formal service providers, obtaining a more accurate and direct assessment of the home environment, linking parents with other support services, and reminding parents that excessive punishment or neglect of children are not condoned in our society (470).

<sup>11</sup>Visiting nurses may also be effective in increasing birthweight and lowering infant mortality (94,169).

## IMPROVING CHILDREN'S ACCESS TO EFFECTIVE HEALTH SERVICES

Although this assessment focused largely on preventive strategies for promoting or maintaining children's health, a fundamental question raised in any discussion of children's health is whether systematic differences exist in American children's access to needed health care services.

OTA's review of the available data revealed a consistent relationship between family income and children's use of health care services. Not surprisingly, the higher the family income, the more services a child uses. This relationship appears to be stronger the sicker the child. Very healthy children do not differ widely by income group—they all see physicians infrequently—but the frequency with which American children who are sick see a physician depends very much on their income.

The relationship between family income and children's use of health care services is softened by the availability of health insurance coverage, so that very poor children, who have access to Medicaid, are more similar to middle-income children in the frequency of use of medical care than are other poor or low-income children (see figure 1-2). Indeed, children on Medicaid appear to have as many general checkups and immunization visits as middle-income privately insured chil-

Figure 1-2.—U.S. Children's Medical Visits: Mean Number of Visits by Family Income, 1980

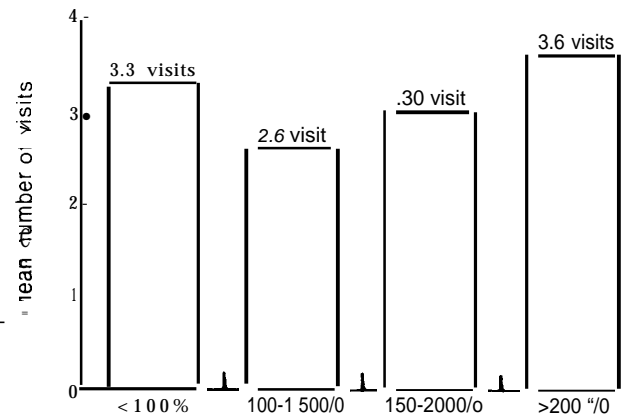

Family income as percentage of Federal poverty level  
SOURCE: Office of Technology Assessment 1988 based on data from J. A. Butler, W. D. Winter, J. D. Singer, et al. "Medical Care Use and Expenditure Among Children and Youth in the United States: Analysis of a National Probability Sample." *Pediatrics* 76(4): 495-507, 1985.

dren (except for those enrolled in health maintenance organizations) (45). As might be expected, having a generous health insurance plan has a greater effect on the use of medical care for children in poverty than it does for other children. Poor children whose families pay a large amount out of their own pockets use much less care than

do those who receive free care (383). Parents do not appear to be particularly good at discriminating between visits that are likely to be highly effective and those that are not (383). When parents cut back on visits, they don't just cut back on care that is not likely to make much difference to the course of illness; they reduce in equal measure visits for conditions for which medical care is highly effective.

Family income and health insurance status influence not only the amount of health care U.S. children receive but also the site in which they receive it. Poor children—both those with Medicaid eligibility and those without—are much more likely to receive care in a health clinic, a hospital emergency room, or outpatient department than are middle-income children.

The result of these systematic differences in the frequency of use of services and the site of care suggests that poor children are treated very differently from nonpoor children by the U.S. health care system. For poor children, the availability of adequate health insurance makes a big difference in whether they get care they need; however, Medicaid eligibility means that poor children are more likely to obtain medical care at a hospital or public clinic than in a private physician's practice.

OTA estimates that in 1986, between 14 and 19 percent of all American children under 13 years of age had no health insurance eligibility whatsoever. Children without health insurance are heavily concentrated among the poor and the near poor (family incomes between 100 and 150 percent of poverty): 61 percent of all children reported to be uninsured in 1986 were poor or near poor.

Almost 40 percent of poor children in intact families have no health insurance. In fact, poor children in two-parent families are much less likely to have health insurance than are poor children living with never married mothers, whose rate of uninsuredness is at most 16 percent. This difference can be explained by the fact that children in intact families in poverty have somewhat higher incomes on average than do those in households headed by single mothers, making fewer of them eligible for Medicaid on the basis of income.

The existence of Medicaid is clearly a great benefit for eligible children. As a federally aided, State-administered program of medical assistance for low-income people, Medicaid enhances access to health care for the poor. Because each State designs and administers its own program within Federal guidelines, however, the adequacy of Medicaid in meeting the needs of children varies widely across the States.

Federal legislation has been expanding Medicaid eligibility for children since 1984. By July 1988, all children through age 6 who meet the income and resource requirements of the AFDC program, regardless of whether they are actually eligible for AFDC, will be eligible for Medicaid. Because the AFDC income standards are State-specific, however, the eligibility criteria are still varied and, in many States, stringent. In 1986, less than one-half of all American children under 13 years of age in poverty were covered by Medicaid (672).

The Omnibus Budget Reconciliation Act of 1986 (OBRA-86) (Public Law 99-509) gave States the right to extend Medicaid on a phased-in basis to all children under 5 years of age whose incomes and resources put them below the Federal poverty line. As of January 1988, only 26 States had extended eligibility. More recently, the Omnibus Budget Reconciliation Act of 1987 (OBRA-87) (Public Law 100-203) permitted States to offer Medicaid to infants whose family incomes are below 185 percent of the Federal poverty level and to children up through age 8 with family incomes below the poverty level.

Physicians who care for Medicaid patients encounter severe restrictions on the payments they receive. In general, Medicaid fees lie well below the fees paid by Medicare, which are in turn lower than those paid by the private sector. The disparity grows with every year. Between 1982 and 1984, for example, private physicians' fees increased by 13.2 percent, while the median Medicaid fee for a brief office visit remained virtually unchanged (278). As a consequence of low Medicaid fees, physicians' willingness to participate in Medicaid is limited. Nationally, pediatricians are about average among all specialties in their

School-based health clinics that offer family planning services are promising as an effective way to reduce pregnancy rates among high-risk teenagers. Teenagers have special needs when it comes to family planning services. Because of their need for confidentiality, a caring attitude on the part of staff, and proximity, the usefulness of the existing network of family planning services for teenagers is limited (515a,776a).

At present, 64 percent of the total funding for school-based clinics is provided by public sources; the remaining 36 percent is provided by private sources (e. g., foundations, corporations, private fees). Of the public funding for school-based clinics, the bulk is provided by States through the MCH block grant or State-only funds (333a). Medicaid's EPSDT program provides about 14 percent of the total funds for school-based clinics. Other Federal programs, including Title XX (Social Services), Title X (Family Planning), and the community health centers program, provide about 6 percent of the total funds.

As a comprehensive program of preventive care for Medicaid-eligible children under 21 years of age, EPSDT is potentially available to fund a greater proportion of the services provided by school-based clinics offering family planning services. In some States, however, school-based clinics are not recognized as Medicaid providers because they do not have a physician on staff. Furthermore, States can restrict payment to school-based clinics by stipulating very few screening visits for adolescents under the EPSDT periodicity schedule. To address these problems, Federal EPSDT regulations could be changed to require States to certify as EPSDT providers clinics that serve schools and to mandate a minimum number of EPSDT screening visits for adolescents.

Implementing this option would still leave to local jurisdictions the decisions about what kinds of services to provide and in what schools. This option would merely enable localities that want to offer family planning and other health services to high-risk adolescents through school-based clinics to make greater use of Medicaid funds,

## Promoting Effective Newborn Screening Programs

Option 4: The Federal Government, acting through the Division of Maternal and Child Health, could use newborn screening grant funds to encourage States to develop coordinated newborn screening programs.

The effectiveness and costs of newborn screening depend on the accurate identification of infants with the target disorders and coordination of screening with followup and treatment services. Experts have long agreed that the quality and efficiency of newborn screening programs could be enhanced by the development of regional screening programs, particularly where small State populations and low budgets restrict access to high quality screening services (e.g., 442). Currently, however, there is no ongoing system in place to assist States in developing regional programs.

At present, there are only three regional newborn screening programs in the United States, together accounting for about 20 percent of births (281). A majority of births (about 71 percent) are covered by State screening programs, most of which have a centralized laboratory, but only some of which have an organized program of services linking the laboratory to followup, treatment, and monitoring. A few States, accounting for about 9 percent of all births, operate without either a central laboratory or a centrally organized program, thus relying on an informal network of families, physicians, and a combination of public and private laboratories to provide screening and followup. In some areas, the lack of a coordinated network of services may be putting infants at risk of not being screened or of not receiving appropriate treatment.

The importance of program organization and management in achieving the theoretically feasible levels of effectiveness and efficiency of newborn screening argues for an aggressive Federal posture in encouraging the development of high-quality, low-cost newborn screening programs.

The Centers for Disease Control's monitoring of the accuracy and precision of screening tests through its laboratory proficiency testing program addresses part, but not all, of the problem. The

U.S. Department of Health and Human Services, acting through the Division of Maternal and Child Health in the Public Health Service, could take an active role in encouraging and coordinating the development of regionalized newborn screening programs through its already existing oversight authority and its discretionary funds.

**Option 5:** The Federal Government could increase funding for research on the effectiveness of newly developed tests designed for routine newborn screening.

A number of States are considering inclusion in their screening programs of newly developed tests for cystic fibrosis, sickle cell anemia, biotinidase deficiency, and congenital adrenal hyperplasia. Adequate funding of research on the effectiveness of screening and treatment for these four disorders before the new tests diffuse widely into routine screening is needed to ensure the appropriate use of resources.

The value of newborn screening for cystic fibrosis, the most common of the disorders currently under consideration for inclusion in screening programs, is currently unknown. Carefully designed research studies of both accuracy of detection and effectiveness of early treatment are needed to make good judgments about the appropriate place of tests for cystic fibrosis in newborn screening programs. One such study of cystic fibrosis, funded by the National Institutes of Health, is already underway (166).

A federally funded study of one aspect of early treatment for sickle cell anemia was recently conducted (198). That study found that the use of prophylactic antibiotics in affected infants was successful in reducing the risk of sudden death due to overwhelming infection early in life (198). Other issues in the screening and treatment aspects of newborn screening for sickle cell anemia have not yet been resolved. Such issues include problems in counseling and followup of sickle cell carriers.

Tests for biotinidase deficiency and congenital adrenal hyperplasia are already being included in many State screening programs. No adequate long-term studies to determine the value of screening for these two disorders have yet been done.

## Encouraging Appropriate Well-Child Care

**Option 6:** The Federal Government could encourage States to develop EPSDT screening protocols that combine fewer well-child care visits than are recommended in the American Academy of Pediatrics (AAP) guidelines with real increases in physician fees.

For the poorest children who are eligible for Medicaid, access to well-child care needs to be dealt with either through the regular Medicaid program or through the Medicaid's EPSDT program. States have established EPSDT screening protocols that typically include fewer well-child visits than the 13 recommended in AAP guidelines but more than the 7 visits recommended for childhood immunizations in the first 6 years of life. But as the EPSDT program has been implemented by the States, only a minority of eligible Medicaid children actually do have EPSDT visits in any year.

There are several potential explanations for this situation. First, 32 States explicitly allow Medicaid providers to bill for routine checkups for children under the regular Medicaid program, so many children may be receiving well-child services through this source. Second, the EPSDT program in many States is not well integrated with



Photo credit: Children Hospital National Medical Center

A schedule of well-child care visits that corresponds to the recommended schedule for childhood immunizations is both effective and cost-saving to the U.S. health care system.

the primary health care system; EPSDT screening sites are separate from children's usual sources of medical care. Third, States have not aggressively recruited providers to the EPSDT programs, and private providers may be reluctant to undertake the reporting commitments required by EPSDT. Finally, rates of payment for EPSDT screens are generally low.

To increase recruitment of providers to EPSDT, one of the key incentives is the level of payment offered by Medicaid for EPSDT services. The evidence supporting the provision of more well-child care visits than the number required for complete immunization is very limited. Thus, States could limit the number of well-child care visits under EPSDT to the seven required for immunizations and would be able to provide higher rates of payment to EPSDT providers without incurring additional program costs.

Whether this option would actually be cost-neutral to Medicaid programs is uncertain, because Medicaid children do not now receive the full complement of well-child care visits, and higher enrollments in EPSDT could actually increase the number of visits as well as the reimbursements per visit. Nevertheless, OTA's analysis indicates that improved adherence to clearly effective and cost-effective well-child care could be worth the immediate outlays.

Such a strategy would be counterproductive if only one part were implemented by the States. That is, if the States were to limit the EPSDT periodicity schedule without substantially increasing rates of payment for EPSDT screenings offered by private physicians, children might not receive the basic number of well-child care visits that are so clearly cost-saving to the U.S. health care system.

Reductions in the number of well-child care visits should not be confused with reductions in the scope and availability of followup services. Once problems are identified in Medicaid eligible children, the availability of diagnostic and treatment services is critical to these children's health status.

**Option 7:** Congress could require States to offer children required followup services identified in EPSDT screens, regardless of whether the services are covered in the State's Medicaid plan.

Once a child has entered the EPSDT screening system, the State is mandated to provide vision, hearing, and dental services but is not required to offer other followup care as needed above and beyond the services outlined in the State's Medicaid plan. This option would increase the probability that children's health problems identified by EPSDT screens are actually dealt with by Medicaid.

In States that contract with private providers for EPSDT screens, this option would encourage providers to enroll children in EPSDT. The option might discourage States from expanding Medicaid children's access to EPSDT services, however, because the State would lose control over covered services.

### **Encouraging the Use of Child Safety Restraints in Automobiles**

**Option 8:** The Federal Government, operating through its highway funding authority, could encourage those States whose child safety restraint laws are not very stringent to adopt more rigorous standards.

Child motor-vehicle safety-restraint laws have indisputably reduced serious injuries in very young children, and all States currently have laws requiring the use of infant or child restraints. The details of these State laws differ (636). To enhance the safety of children in States with less effective laws, the Federal Government could promulgate a model child safety restraint law whose adoption could be required for the receipt of Federal highway funds.

### **Encouraging the Development of Nurse Home Visitor Programs**

**Option 9:** Congress could mandate that the U.S. Department of Health and Human Services fund experiments and evaluations of home visitor programs in populations at high

risk for low birthweight or child maltreatment and other injuries.

Home visitor programs are labor intensive and therefore costly, and the evidence on their effectiveness is based on a small number of programs run by dedicated, enthusiastic, and particularly skilled people, so it is premature to conclude that the home visitor approach should be broadly applied. Nevertheless, the evidence is certainly strong enough to warrant more widespread experimentation with the home visitor concept as a method of improving the outcome of pregnancy and the health of young children. Possible funding and coordinating agencies include the National Center on Child Abuse and Neglect (NCCAN), the Division of Maternal and Child Health in the Public Health Service, and the Centers for Disease Control, all of which have jurisdiction over child health problems for which home visitor programs may be effective.

Funding for experimental programs needs to be directed to those with the strongest evaluation designs if useful information on effectiveness is to be achieved. The performance of NCCAN in funding valid research has been disappointing. Peer review of proposals for demonstration and evaluation grants or contracts is one way of directing funds to the programs with the strongest evaluation designs.

The U.S. Department of Health and Human Services already has the power to issue waivers under the Medicaid program to States that offer additional services (such as home visitors) to selected subgroups of Medicaid eligibles as an inducement to participate in case-management systems where the freedom to choose a provider is restricted (Sec. 1915(b) of the Social Security Act). To obtain a waiver, however, a State must show that the proposed program will as a whole reduce costs or slow the rate of increase in Medicaid program costs. It may be difficult to justify an expensive program such as home visitors on the basis of cost-savings to Medicaid. More flexibility on the part of the Health Care Financing Administration in approving waivers containing these services would enhance the development of such programs.

## Improving Poor Children's Access to Physicians' Care

**Option 10:** Congress could mandate that eligibility for Medicaid be extended to all children under 9 years of age in families with incomes below the Federal poverty line.

*OBRA-87* gave States the option to expand Medicaid to cover all poor children under 9 years of age and offer Medicaid to infants in families with incomes up to 185 percent of the Federal poverty line. Making Medicaid eligibility for all poor children under age 9 mandatory would eliminate the inevitable disparity among States in eligibility that will result from the optional provisions of *OBRA-87* and would improve access to care for such children.

The available evidence suggests that this option would be likely to improve the health status of newly eligible Medicaid children because it would increase their use of effective health care. It would also be costly to Medicaid because free care would bring about more use of medical care by these children.

**Option 11:** Congress could require States to increase the fees paid to physicians when they care for Medicaid children.

For children who are eligible, the Medicaid program offers a comprehensive array of health services. The key problem, however, is finding adequate sources of care. Physician participation in the Medicaid program varies from place to place, but it is clear that there are administrative and payment barriers that discourage Medicaid families from using private practices.

The low levels of Medicaid fees in comparison to private fees in many States is of particular concern. By mandating increased fee levels for physicians who treat Medicaid children, Congress could arrest the tendency for Medicaid children to seek primary care in sites different from those used by non-Medicaid children. Increased fee levels would also raise Medicaid program costs, however, and could encourage some unnecessary use of health services by Medicaid patients.

Option 12: Congress could increase direct Federal subsidies of health care providers—through community health centers, maternal and child health projects, and other programs administered by State and local governments—to provide primary health care for poor families.

An alternative to expanding Medicaid eligibility would be for the Federal Government to increase its commitment to funding publicly subsidized providers of health care for the poor. The erosion of real Federal funding of programs that provide health care services for poor children and pregnant women in the last 9 years—a period when the population of poor and uninsured children grew—has caused an increasing strain on these services.

Increasing funding for direct provision of health services to the poor would have the advantage of permitting States or localities to target serv-

ices to areas of greatest need and to tailor programs to the needs of poor women and children. Programs of enriched prenatal care, for example, can be more easily coordinated through State or local governments or community health centers than through physicians' private practices.

By definition, however, the funding of public or publicly subsidized clinics for the poor tends to separate provision of care for poor children and pregnant women from care given to the nonpoor. The implications of separate streams of medical care are unclear. Although targeted programs can offer enhanced services tailored to the multiple needs of poor children and their families, their quality and effectiveness are likely to vary widely across areas. Without freedom to use other settings of care made possible by access to public or private health insurance, some poor women and children could ultimately receive lower quality care.



---

Part I

# Overview of Children's Health

Chapter 2

# **Children's Health Status: Current Trends**

# CONTENTS

	<i>Page</i>
Introduction .....	31
The Problem of Infant Mortality .....	31
Infant Mortality in the United States and Other Developed Countries .....	32
U.S. Infant Mortality Trends .....	34
Why the Slowdown in Improvement in U.S. Infant Mortality Rates? .....	35
Conclusions .....	45
Children's Health Beyond Infancy .....	46
Children's Mortality Rates. ....	47
Children's Immunization Status .....	48
Growth Stunting .....	49
Conclusions .....	49

## Figures

<i>Figure No.</i>	<i>Page</i>
2-1. Provisional U.S. Infant Mortality Rates, January 1970 to July 1986. ....	36
2-2. U.S. Infant, Neonatal, and Postneonatal Mortality Rates, by Birthweight, 1980 Birth Cohort .....	37
2-3. Percentage of U.S. Infants Under 1 Year of Age in Poverty, 1976-86 .....	42
2-4. Estimated State and Federal Funding for Maternal and Child Health Services, 1978-84. ....	44

## Tables

<i>Table No.</i>	<i>Page</i>
2-1. Comparison of Infant Mortality Rates in the United States and Other Countries, 1985 .....	32
2-2. Comparison of Birthweight-Specific Mortality Rates and the Incidence of Low Birthweight in the United States, Sweden, and England/Wales, 1980 .....	33
2-3. Comparison of Birthweight-Specific Mortality Rates and the Incidence of Low Birthweight in the United States (Selected States) and West Germany, 1983 .....	34
2-4. Changes in U.S. Birthweight-Specific Mortality Rates From 1980 to 1983.....	38
2-5. U.S. Birthweight Distribution, Live Births, 1977, 1981, 1984 .....	38
2-6. Changes in California's Birthweight-Specific Neonatal Mortality Rates, 1978, 1981, 1984 .....	39
2-7. Medicaid Expenditures Per Child Recipient of Aid to Families With Dependent Children, 1978-84 .....	43
2-8. Federal Appropriations for Direct Public Health Programs, Selected Fiscal Years 1978-87. ....	44
2-9. Percentage of Mothers Who Obtain Early, Late, or No Prenatal Care, by Race, 1977, 1981, 1984.....	45
2-10. Percentage of All Births in the United States to Mothers With Selected Demographic Risk Factors, 1977,1981, 1984. ....	45
2-11. U.S. Children's Mortality Rates by Age and Race, Selected Years 1968-84. . .	47
2-12. Leading "Causes" of Death Among U.S. Infants and Children, 1984 .....	48

# Children's Health Status: Current Trends

## INTRODUCTION

In any study of children's health, an obvious first question is whether American children are as healthy as they can be and whether their health has been improving in recent years. This chapter addresses that question by examining recent trends in a number of indicators of children's health. The greatest emphasis of this chapter is on infant mortality, but other measures of children's health are examined as well.

The infant mortality rate<sup>1</sup> has long been a primary indicator of the overall health status of nations for two reasons: first, it tends to be closely associated with access to adequate food, shelter, education, sanitation, and health care (426); and second, it is relatively easy to monitor with basic vital statistics collected in most countries. Indeed, its wide availability as a quality-of-life indicator has given infant mortality a visibility in policy

<sup>1</sup>The infant mortality rate for any year is defined as the number of infant deaths under 1 year of age per 1,000 live births in the same year. The infant mortality rate is the sum of two components: the neonatal mortality rate (defined as the number of infant deaths under 28 days per 1,000 live births), and the postneonatal mortality rate (defined as the number of infant deaths between 28 days and 1 year per 1,000 live births). When linked birth and death certificates are available, the postneonatal mortality rate is usually defined as the number of infant deaths between 28 days and 1 year per 1,000 neonatal survivors. Unless otherwise indicated, the former definition will be used in this chapter.

debates that it might not otherwise have. The much higher rate of infant mortality in the South than in other parts of the United States, for example, has propelled leaders in that region to come up with a plan to reduce the disparity (604). The infant mortality rate may even overshadow other important, but much less easily measured, dimensions of children's health status that take account of the full physical, cognitive, and emotional well-being of children in this country.

One of the problems in evaluating children's health is that good indicators of children's health status are hard to find. More research aimed at developing valid measures that take a broader view of children's health would certainly enhance our understanding of the health problems of children in this country. Lacking such measures at present, OTA has focused in this chapter on those measures for which recent data (into the 1980s) are available.

The first part of this chapter examines U.S. infant mortality rates and the reasons for the recent slowdown in improvement experienced in this country. The second part of the chapter examines several indicators of children's health status in the period beyond infancy.

## THE PROBLEM OF INFANT MORTALITY

The current status of and trends in infant mortality rates in the United States are matters of widespread concern (426,666). After a period of rapid decline from the mid-1960s through the 1970s, the pace of the decline in the U.S. infant mortality rate may be significantly slowing. Recent final mortality data show an average annual decline in the U.S. infant mortality rate of 3.3 percent for the 3-year period from 1981 to 1984 (709). This is the lowest percentage reduction in the U.S. infant mortality rate in any 3-year period since 1965.

Hope that the trend from 1981 to 1984 is an aberration from an otherwise substantial and continuous decline in the U.S. infant mortality rate since the mid-1960s is not supported by the most recent provisional data on U.S. infant mortality.<sup>2</sup>

<sup>2</sup>Provisional mortality data and final mortality data are both based on birth and death certificates reported by State vital statistics offices. In this chapter, provisional data for a given year are for the preceding 12 months ending with June 30; final mortality data, however, are for the calendar year. Because of differences in reporting systems, provisional data are not always comparable to final data. Trends within each system are highly correlated, however, so provisional data on infant mortality rates may be used in lieu of final data to provide a reasonable estimate of the most recent trends (337).

These provisional data indicate that the average annual rate of decline in the U.S. infant mortality rate for 1985 and 1986 was only 1.4 percent—a smaller decline than the previous low for a 2-year period. At this rate of decrease in U.S. infant mortality rates, the U.S. Surgeon General's objective of reducing the U.S. infant mortality rate to 9.0 infant deaths per 1,000 live births by 1990 (715) will not be reached.

Not only has there been a decline in the rate of decrease in the overall U.S. infant mortality rate, but large racial disparities in infant mortality rates persist. Over the past 24 years, black infant mortality has been consistently higher than white infant mortality by almost two to one (see app. C). In 1985, the infant mortality rate was 18.2 infant deaths per 1,000 live births for blacks and 9.3 for whites.

### Infant Mortality in the United States and Other Developed Countries

In comparison to the ranking of several other industrialized countries, the United States' ranking with respect to infant mortality is unfavorable (see table 2-1). In 1985, the United States had 10.6 infant deaths per 1,000 live births, and its infant mortality rank of 17th was unchanged from 1980. Even if the higher infant mortality rates of blacks and other minorities are excluded from the comparisons for 1985, the remaining (white) U.S. rate of 9.3 deaths per 1,000 live births would still yield a comparatively low rank of 10th. If the U.S. infant mortality rate in 1985 had been equal to that achieved by the country with the lowest rate (Japan, with a rate of 5.5 infant deaths per 1,000 live births), the United States would have had 19,350 fewer infant deaths that year—a sum greater than the number of deaths of all children between 1 and 15 years of age in 1985.

A country's infant mortality rate depends both on the incidence of low birthweight and on birthweight-specific infant mortality rates. The international ranking of the United States with respect to the incidence of low birthweight is rather poor. In 1980, the United States ranked 14th in the percentage of live births that were low birthweight (less than 2,500 grams) and 15th in the percentage of live births that were very low birthweight (less than 1,500 grams) (296).

**Table 2-1.—Comparison of Infant Mortality Rates<sup>a</sup> in the United States and Other Countries, 1985**

Country	Infant mortality rate, 1985
1. Japan . . . . .	5.5
2. Finland . . . . .	6.3
3. Sweden . . . . .	6.7
4. Switzerland . . . . .	6.9
5. Denmark . . . . .	7.9
6. Canada . . . . .	7.9
7. Netherlands . . . . .	8.0
8. France . . . . .	8.1
9. Norway . . . . .	8.3
10. Ireland . . . . .	8.9
11. United Kingdom . . . . .	9.4
12. Belgium . . . . .	9.4
13. West Germany . . . . .	9.5
14. East Germany . . . . .	9.9
15. Australia . . . . .	9.9
16. Spain . . . . .	10.5 <sup>b</sup>
17. United States . . . . .	10.6
18. Italy . . . . .	10.9
19. New Zealand . . . . .	11.0
20. Austria . . . . .	11.0
21. Israel . . . . .	11.9
22. Brunei . . . . .	12.0
23. Malta . . . . .	13.6
24. Greece . . . . .	14.0
25. Czechoslovakia . . . . .	15.3 <sup>c</sup>
26. Bulgaria . . . . .	15.8
27. Cuba . . . . .	16.5
28. Poland . . . . .	18.5
29. Hungary . . . . .	20.4
30. Romania . . . . .	23.4 <sup>c</sup>

<sup>a</sup>The infant mortality rate is defined as the number of infants who die in the first year of life per 1,000 live births.  
<sup>b</sup>This is Spain's infant mortality rate in 1983.  
<sup>c</sup>These infant mortality rates are for 1984.

SOURCE: A Von Cube, Population Reference Bureau, Washington, DC, personal communication May and September 1987.

U.S. birthweight-specific mortality rates are comparable or superior to birthweight-specific mortality rates in a number of countries that have the same or a lower overall infant mortality rate (158,236). In 1980, for example, the United States had an overall infant mortality rate of 12.6 infant deaths per 1,000 live births—higher than the rates in Sweden (with 6.9 infant deaths) and England/Wales (with 12.1 deaths) (501) (see table 2-2). In terms of birthweight-specific neonatal and infant mortality rates in 1980, the United States generally did slightly worse than Sweden at the normal birthweight intervals, but substantially better than Sweden at the low birthweight intervals (see table 2-2). Sweden had lower infant and neonatal mortality rates than the United States because Sweden had a more favorable birth distribution than the United States; in the United States, 6.84 percent of live births in 1980 were low

**Table 2-2.—Comparison of Birthweight-Specific Mortality Rates and the Incidence of Low Birthweight Births in the United States, Sweden, and England/Wales, 1980**

	United States <sup>a</sup>	Sweden <sup>b</sup>	England/Wales <sup>b</sup>
<b>Birthweight-specific neonatal mortality rate<sup>c</sup></b>			
<i>Low birth weight:</i>			
1,000-1,499g .....	183.3	217.2	NA <sup>d</sup>
< 1500g .....	437.7	NA	359.8
1,500-1,999g .....	49.7	56.4	NA
2,000-2,499g .....	15.7	17.5	17.7
<2,500g .....	92.9	NA	NA
<i>Normal birth weight:</i>			
2,500-2,999g .....	4.1	4.2	4.9
3,000-3,499g .....	2.0	1.6	2.4
3,500-3,999g .....	1.4	1.0	1.8
4,000-4,499g .....	1.5	1.2	NA
>2,500g .....	2.2	NA	NA
>4,000g .....	1.9	NA	2.3
>4,500g .....	3.7	1.2	
<b>Birthweight-specific infant mortality rate<sup>e</sup></b>			
<i>Low birthweight</i>			
1,000-1,499g .....	212.8	235.0	NA
<1,500g .....	465.6	NA	NA
1,500-1,999g .....	65.3	67.0	NA
2,000-2,499g .....	24.6	21.7	NA
<2,500g .....	106.3	NA	NA
<i>Normal birthweight:</i>			
2,500-2,999g .....	8.9	6.7	NA
3,000-3,499g .....	4.9	3.1	NA
3,500-3,999g .....	3.5	2.2	NA
4,000-4,499g .....	3.4	2.1	NA
>2,500g .....	5.0	NA	NA
>4,000g .....	3.9	NA	NA
>4,500g .....	5.9	1.7	NA
Overall infant mortality rate .....	12.6	6.9	12.1
<b>Incidence of low birthweight</b>			
Percentage of birthweights <1,500g .....	1.150/0	0.49%	0.770/0
Percentage of birthweights <2,500g .....	6.840/0	4.030/0	6.790/0

<sup>a</sup>U.S. Department of Health and Human Services, Public Health Service, Centers for Disease Control, preliminary tables from the 1960 National Infant Mortality Surveillance Project (NIMS), May 1986. All birthweight-specific deaths of multiple birth infants were assigned to the neonatal period.

<sup>b</sup>U.S. Department of Health and Human Services, Public Health Service, National Center for Health Statistics, *Proceedings of the International Collaborative Effort on Perinatal and Infant Mortality*, Vol. I (Hyattsville, MD: NCHS, August 1985).

<sup>c</sup>The birthweight-specific neonatal mortality rate is defined as the number of infants in a given birthweight interval who die in the first 28 days of life per 1,000 live births in that interval.

<sup>d</sup>NA = not available.

<sup>e</sup>The birthweight-specific infant mortality rate is defined as the number of infants in a given birthweight interval who die in the first year of life per 1,000 live births in that interval.

<sup>f</sup>Institute of Medicine, *Preventing Low Birthweight* (Washington, DC: National Academy Press, 1985). Swedish percentage IS for 1978.

SOURCE: Office of Technology Assessment, 1988.

birthweight, while in Sweden, only about 4.03 percent of live births were low birthweight (see table 2-2). In terms of birthweight-specific mortality rates, the United States did worse than England/Wales at very low birthweight intervals, but better than England/Wales at moderately low and normal birthweight intervals where many more births are concentrated. In England/Wales, 6.79 percent of live births in 1980 were low birthweight; only 0.77 percent of live births were very low birthweight.

In 1983, the United States had higher overall neonatal and infant mortality rates than West Germany (see table 2-3). According to calculations for the United States based on aggregated data from nine States, birthweight-specific mortality rates in the United States in 1983 were lower than those in West Germany, but West Germany had a more favorable birthweight distribution; about 6.7 percent of live births in the United States were low birthweight, as compared to 5.6 percent in West Germany (see table 2-3). Insecure, the evi-

**Table 2-3.—Comparison of Birthweight-Specific Mortality Rates and the Incidence of Low Birthweight Births in the United States (Selected States) and West Germany, 1983**

	United States (selected States) <sup>a</sup>	West Germany <sup>b</sup>
<b>Birthweight-specific neonatal mortality rate<sup>c</sup></b>		
<i>Low birth weight:</i>		
<1,000g . . . . .	<b>658.7</b>	<b>688.3</b>
1,000-1,999g . . . . .	<b>63.6</b>	192.8
<b>2,000-2,499g . . . . .</b>	<b>12.2</b>	<b>14.9</b>
<b>Normal birthweight:</b>		
<b>&gt;2,500 . . . . .</b>	1.8	1.9
All birthweights . . . . .	7.2	5.9
<b>Birthweight-specific infant mortality rate<sup>d</sup></b>		
<i>Low birth weight:</i>		
<1,000g . . . . .	701.7	824.4
1,000-1,999g . . . . .	91.1	137.9
2,000-2,499g . . . . .	22.1	27.9
<i>Normal birth weight:<sup>e</sup></i>		
22,500g . . . . .	4.6	5.1
All birthweights . . . . .	11.1	10.3
<b>Incidence of low birthweight</b>		
Percentage of birth-weights < 1,500g . . . .	0.490/0	0.270/0
Percentage of birth-weights < 2,500g . . . .	6.7% <sup>e</sup>	5.6%

<sup>a</sup>The neonatal mortality rates for the United States were calculated from aggregated births and neonatal deaths in nine States<sup>1</sup> Georgia, Maine, Minnesota, Missouri, North Carolina, New Hampshire, New York (excludes New York City), Vermont, and Wisconsin. Infant mortality rates were calculated for those nine States minus New York State. All birthweight-specific deaths of multiple birth infants were assigned to the neonatal period. U.S. Department of Health and Human Services, Public Health Service, National Center for Health Statistics, *Proceedings of the International Collaborative Effort on Perinatal and Infant Mortality*, vol. I (Hyattsville, MD: NCHS, August 1985).

<sup>b</sup>Herausgeber Statistisches Bundesamt Wiesbaden, Verlag: W Kohlhammer GmbH Stuttgart und Mainz, Bevölkerung und Erwerbstätigkeit, Reihe 1, Gebiet und Bevölkerung, 1983.

<sup>c</sup>The birth weight-specific neonatal mortality rate is defined as the number of infants in a given birthweight interval who die in the first 28 days of life per 1,000 live births in that interval.

<sup>d</sup>The birthweight-specific infant mortality rate is defined as the number of infants in a given birthweight interval who die in the first year of life per 1,000 live births in that interval.

<sup>e</sup>The percentage calculated on the basis of nine States is 66 percent, the percentage calculated on the basis of eight States is 67 percent.

SOURCE: Office of Technology Assessment, 1988.

dence that is available indicates that the relatively poor international ranking of the United States with respect to infant mortality is largely due to the country's unfavorable birthweight distribution.

## U.S. Infant Mortality Trends

Over the first half of this century, the U.S. infant mortality rate declined by 100 percent, reaching about 50 infant deaths per 1,000 live births

in 1950. The subsequent trends in the U.S. infant mortality rate can be divided into two time periods:

- 1950 to 1967, represented by little change in infant mortality rates for whites and even less change in the rates for blacks; and
- 1968 to 1984, represented by a rapid decline in infant mortality for both whites and blacks.

Because vital statistics data from the early 1960s may not be as accurate as data from the late 1960s and subsequent years, particularly for blacks,<sup>3</sup> the discussion that follows emphasizes the years after 1967.

U.S. infant, neonatal, and postneonatal mortality rates and annual percentage changes for the years 1968 to 1985 are presented in appendix C. From 1968 to 1985, the U.S. infant mortality rate declined by about 50 percent for both whites and blacks, reaching 9.3 infant deaths per 1,000 live births for whites and 18.2 infant deaths for blacks. The average annual compound rate of decline in overall U.S. infant mortality during this period was 4.1 percent.

Since 1981, there has been a substantial, unprecedented, and statistically significant slowdown in the rate of improvement in U.S. infant mortality rates. From 1981 to 1984, the U.S. infant mortality rate declined by an average annual compound rate of 3.3 percent (709). The 3.3-percent average annual decline in the U.S. infant mortality rate from 1981 to 1984 not only was down from a 4.1-percent decline from 1977 to 1981, but it was also lower than the 4.5-percent average annual decline for the entire period from 1968 to 1981 (709).

Provisional data on U.S. infant mortality rates for 1986 indicate that the situation is continuing to deteriorate. Provisional data for each year from 1982 through 1986 indicate a progressive decrease

<sup>3</sup>The reason vital statistics data from the early 1960s, particularly for blacks, may not be as accurate as data from the late 1960s and subsequent years is that in the 1960s there may have been a considerable number of out-of-hospital births to blacks. One investigator notes that from 1950 to 1967, nonwhite out-of-hospital births in the United States declined from 42 percent of nonwhite births to 7 percent. A State-level study of the 1950-67 period showed that the reported low birthweight rate was highly correlated with the percentage of nonwhite births occurring in the hospital. This suggests that as more nonwhite births occurred in hospitals and were reported, low birthweight and infant mortality increased (126).

in the average annual compound rate of decline in the U.S. infant mortality rate (709).<sup>4</sup> The decline in the provisional U.S. infant mortality rate for 1987 is less than 1.1 percent—a negligible improvement over the previous year,

Although year-to-year fluctuations in reported infant mortality rates are expected, the recent slowdown in improvement of U.S. infant mortality rates cannot be dismissed as random variation around the trend. At OTA's request, the National Center for Health Statistics (NCHS) predicted U.S. infant mortality rates for the 3-year period from 1982 to 1984 on the basis of trends in final U.S. infant mortality rates from 1968 to 1981.<sup>5</sup> The U.S. infant mortality rate NCHS predicted for 1984, 10.4 deaths, was significantly lower than the actual 1984 rate of 10.8 deaths ( $p = 0.01$ ). Had the U.S. infant mortality rate continued to decline after 1981 at the rate predicted by NCHS, the United States would have suffered 1,395 fewer infant deaths in 1984 than actually occurred (339). The disparity between the predicted rate and the actual U.S. infant mortality rate increased further in 1985—the most recent year for which final U.S. infant mortality data are available. The U.S. infant mortality rate in 1985 was 10.6 infant deaths per 1,000 live births, while the rate predicted on the basis of the NCHS regression analysis was 9.9 deaths.

Just how substantial a departure from the past the most recent U.S. infant mortality trends represent is illustrated in figure 2-1. The dashed line shows the U.S. infant mortality rate through July 1986 as predicted on the basis of provisional data for January 1970 to December 1982 (339). The solid line shows the U.S. infant mortality rate as determined from monthly provisional infant mortality data from January 1970 through July 1986. For the years 1983 through July 1986, the solid line substantially departs from the dashed line,

<sup>4</sup>The reduction in the U.S. infant mortality rate, according to provisional data, was 6.6 percent for 1982, 3.5 percent for 1983, 1.8 percent for 1984, 1.9 percent in 1985, 0.9 percent in 1986, and 1.1 percent in 1987 (709). From 1982 to 1986, the average annual reduction in provisional U.S. infant mortality rates was 3 percent (about 71 percent of the average rate of decrease in the provisional rates for 1977 to 1981).

<sup>5</sup>Rates were predicted by a linear regression of the logarithm of infant mortality as a function of time.

## Why the Slowdown in Improvement in U.S. Infant Mortality Rates?

Why the slowdown in improvement in the U.S. infant mortality rate since the early 1980s? To address this question, it is necessary to understand the importance of birthweight as a risk factor for infant mortality. Low birthweight, defined as under 2,500 grams, is a major determinant of infant mortality (296). In 1980, low birthweight infants made up less than 7 percent of the population of newborns in the United States but accounted for 60 percent of all babies who died in infancy (687).

Low birthweight affects infant mortality through its effect on both neonatal mortality and on postneonatal mortality, but the greatest effect is on neonatal mortality. In 1980, 75 percent of all neonatal deaths and 30 percent of all postneonatal deaths in the United States occurred in low birthweight infants (687). As shown in figure 2-2, the risk of death increases as birthweight decreases. In 1980, very low birthweight infants (those weighing under 1,500 grams at birth) had only about 6 chances in 10 of surviving beyond the neonatal period.

Progress in reducing U.S. infant mortality can come either through changes in the distribution of birthweights toward heavier babies or through changes in birthweight-specific infant mortality rates. Historically, most of the progress in the United States since 1960 has been in the realm of improved birthweight-specific mortality rates (8, 211,340,628,754). In fact, between 1960 and 1980, about 91 percent of the improvement in the U.S. infant mortality rate was due to changes in birthweight-specific mortality rates (80). The improvements in birthweight-specific mortality rates from 1960 to 1980 benefited black babies as well as white babies. For blacks, in fact, the percentage decreases in birthweight-specific infant mortality from 1960 to 1980 were higher than the decreases for whites (80).

Improvement in U.S. birthweight-specific mortality rates has continued beyond 1980 (see table 2-4).<sup>6</sup> From 1980 to 1983, declines in birthweight-

<sup>6</sup>Estimates of 1983 birthweight-specific infant mortality rates for the United States were derived by aggregating data from eight States: Georgia, Maine, Minnesota, Missouri, North Carolina, New Hampshire, Vermont, and Wisconsin (687, 706). Comparison of the overall



Figure 2-1.— Provisional U.S. Infant Mortality Rates, January 1970 to July 1986<sup>3</sup>  
(12-month moving averages)

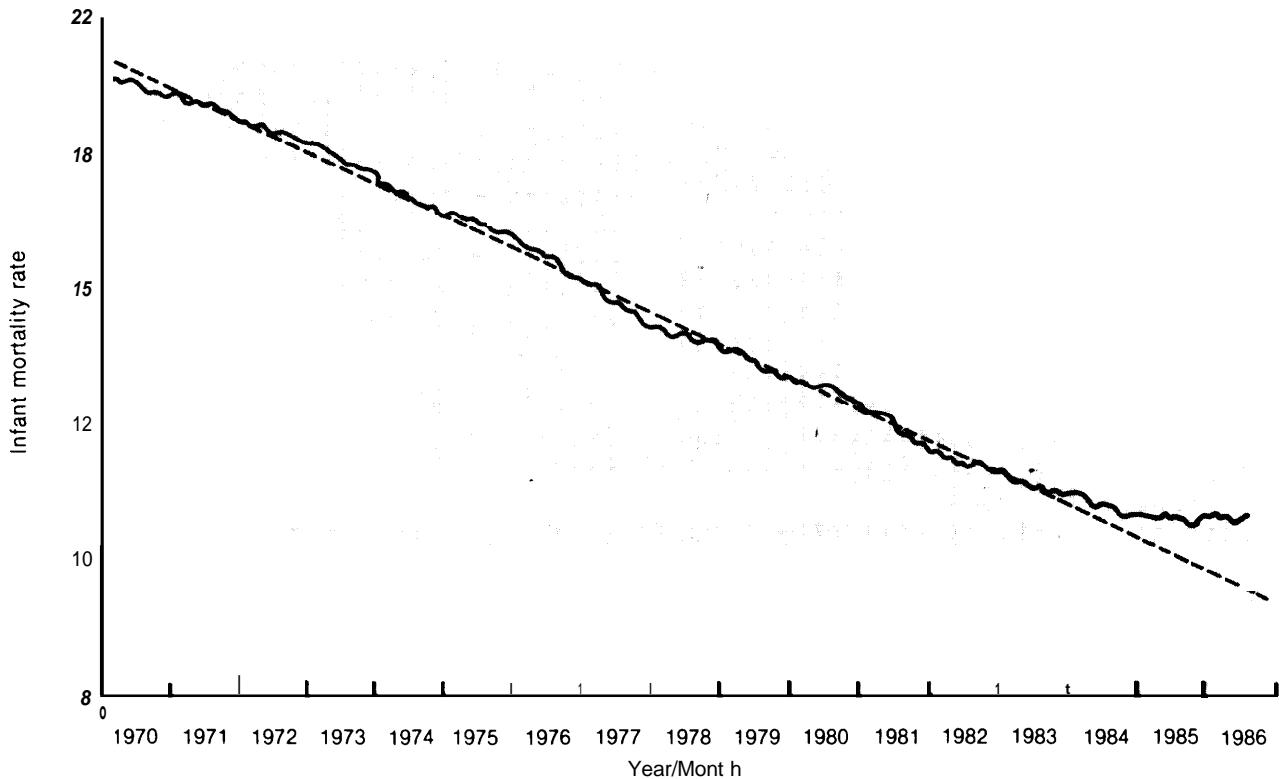

NOTE Dashed line fitted by log-linear regression analysis of provisional U.S. infant mortality rates for January 1970 to December 1982

SOURCE: J Kleinman, National Center for Health Statistics, Public Health Service, U.S. Department of Health and Human Services, Hyattsville, MD, unpublished data from U.S. vital statistics, 1986

specific mortality rates were generally larger among infants born at low birthweights than among infants born at normal birthweights. An important exception was in the group of tiny infants weighing less than 1,000 grams at birth; the decline in birthweight-specific mortality among these infants was less than the decline for normal birthweight infants. The group of infants that experienced the largest decline in birthweight-specific mortality rates from 1980 to 1983 was the group in the birthweight interval from 1,000 to 1,499 grams.

While U.S. birthweight-specific mortality rates have been improving, the birthweight distribution

in the United States has actually deteriorated since 1977. As shown in table 2-5, the percentage of live births at normal birthweights increased slightly from 1977 to 1984, but there was a shift in the distribution of low birthweight babies toward the lowest birthweight intervals (those under 1,000 grams). Had U.S. birthweight-specific mortality rates not improved from 1977 to 1984, the deteriorating birthweight distribution would have resulted in an increase in the overall U.S. infant mortality rate. The overall U.S. infant mortality rate would have increased at an average annual rate of 0.7 percent between 1977 and 1980 and 1.2 percent between 1981 and 1984 (339).<sup>7</sup>

aggregated neonatal and infant mortality rates of this sample of States with the U.S. final mortality statistics for 1983 supports the conclusion that these States were highly representative of the United States—there was almost no difference in the overall rates.

<sup>7</sup>These calculations were based on the assumption that U.S. birthweight-specific mortality rates reported for 1980 held for the entire 1977-84 period.

**Figure 2-2.—U.S. Infant, Neonatal, and Postneonatal Mortality Rates, by Birthweight, 1980 Birth Cohort (singletons)<sup>a</sup>**

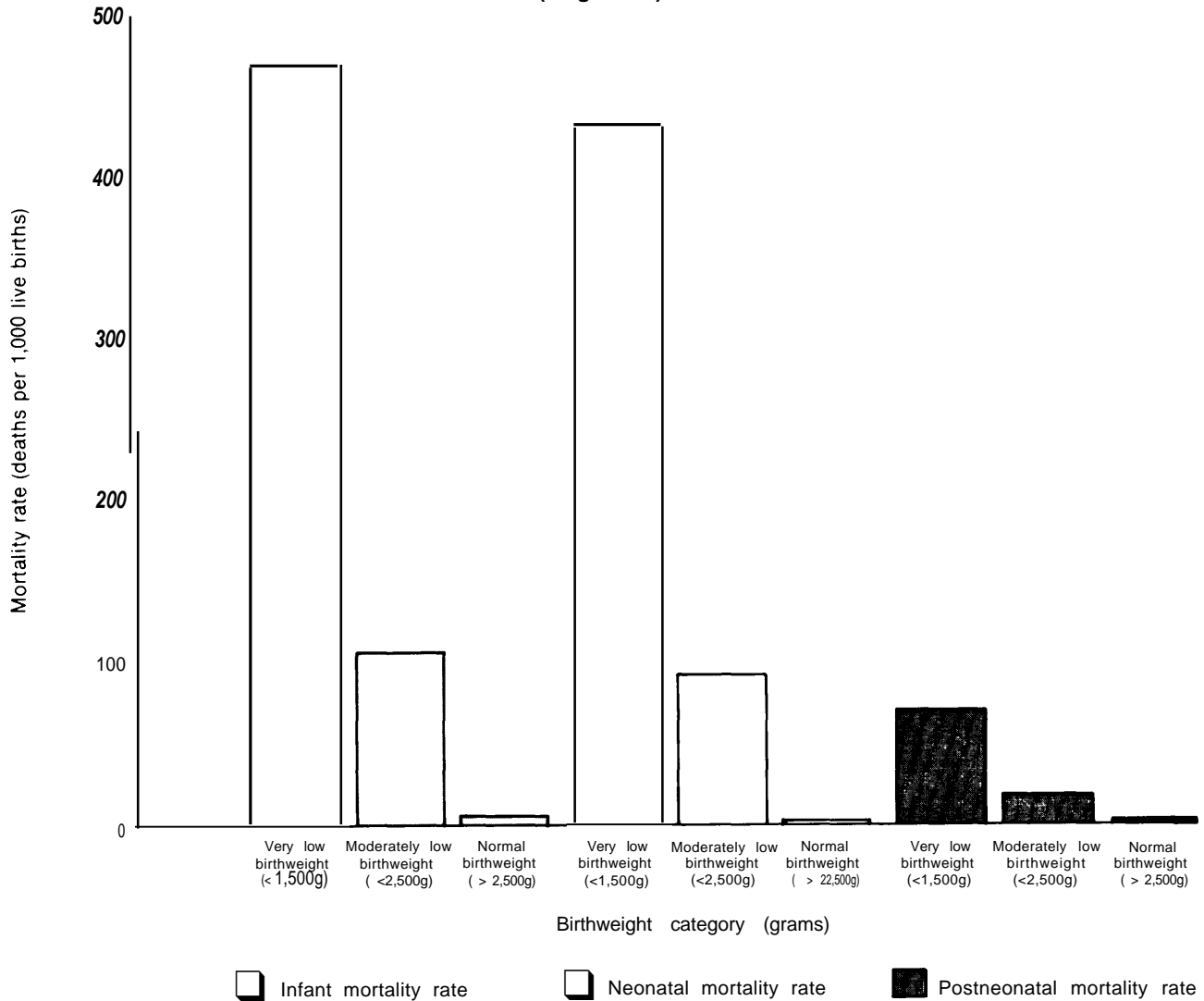

<sup>a</sup>The mortality rates depicted in this figure are for all races combined. For a breakdown of mortality rates by race, see table C-4 in APPENDIX C of this report.

SOURCE: Office of Technology Assessment, 1988, calculated from the preliminary tables from the 1980 National Infant Mortality Surveillance project, U.S. Department of Health and Human Services, Public Health Service, Centers for Disease Control, Atlanta, GA, May 1986.

Furthermore, although U.S. birthweight-specific mortality rates have continued to decline throughout the 1980s, the improvements are coming more slowly now than they did in the late 1970s and the pattern of improvement across birthweights has changed. National birthweight-specific infant mortality rates are available only for 1960 and 1980; to consider recent changes in the pattern of mortality across birthweights, one must use more limited databases compiled in individual States.

Data on birthweight-specific neonatal mortality from California are shown in table 2-6.<sup>8</sup> These data show a substantial slowdown in improvement in the neonatal mortality rates for moderately low birthweight babies (those weighing between 1,500 and 2,499 grams) from the 1978-81

<sup>8</sup>Birthweight-specific neonatal mortality data from California are available only for newborns weighing more than 500 grams. Consequently, the birthweight-specific mortality rates reported in table 2-6 are lower than California's official neonatal mortality rates.

**Table 2-4.—Changes in U.S. Birthweight-Specific Mortality Rates From 1980 to 1983**

	Birth weight-specific neonatal mortality rate <sup>a</sup>			Birthweight-specific infant mortality rate <sup>b</sup>		
	1980c	1983d	Percent change 1980-83e	1980c	1983f	Percent change 1980-83e
<b>Low birthweight:</b>						
<1,000g . . . . .	727.3 <sup>c</sup>	658.7 <sup>d</sup>	-9.4 %/0	753.5 <sup>c</sup>	701.7 <sup>f</sup>	-6.8 %/0
1,000-1,499g . . . . .	183.3 <sup>c</sup>	117.3 <sup>d</sup>	-35.9	212.8 <sup>c</sup>	154.9 <sup>f</sup>	-27.2
1,500-1,999g . . . . .	49.7 <sup>f</sup>	38.1 <sup>g</sup>	-23.3	65.3 <sup>c</sup>	59.8 <sup>f</sup>	-8.4
2,000-2,499g . . . . .	15.7 <sup>c</sup>	12.2 <sup>d</sup>	-22.2	24.6 <sup>c</sup>	22.1 <sup>f</sup>	-9.8
<b>Normal birthweight:</b>						
22,500g . . . . .	2.2 <sup>e</sup>	1.8 <sup>d</sup>	-14.9%/0	5.0 <sup>c</sup>	4.6 <sup>f</sup>	-8.1 0/0
<b>All birthweights . . . . .</b>	<b>8.4<sup>c</sup></b>	<b>7.2<sup>d</sup></b>	<b>-13.8%</b>	<b>12.0<sup>c</sup></b>	<b>11.1<sup>f</sup></b>	<b>-7.60/0</b>

<sup>a</sup>The birthweight-specific neonatal mortality rate is defined as the number of infants in a given birthweight interval who die in the first 28 days of life per 1,000 live births in that interval.  
<sup>b</sup>The birthweight-specific infant mortality rate is defined as the number of infants in a given birthweight interval who die in the first year of life per 1,000 live births.  
<sup>c</sup>Centers for Disease Control, Public Health Service, U.S. Department of Health and Human Services, preliminary table from the 1980 National Infant Mortality Surveillance Project, Atlanta, GA, May 1988. All birthweight-specific deaths of multiple birth infants were assigned to the neonatal period.  
<sup>d</sup>Birthweight-specific neonatal mortality rates for 1983 were calculated from aggregated births and neonatal deaths in nine States: Georgia, Maine, Minnesota, Missouri, North Carolina, New Hampshire, New York (excluding New York City), Vermont, and Wisconsin. U.S. Department of Health and Human Services, Public Health Service, National Center for Health Statistics, *Proceedings of the International Collaborative Effort on Perinatal and Infant Mortality*, Vol. I (Hyattsville, MD: NCHS, August 1985).  
<sup>e</sup>Percent change calculated on unrounded numbers.  
<sup>f</sup>U.S. birthweight-specific infant mortality rates for 1983 were calculated for the nine States noted above minus New York State.  
 SOURCE: Office of Technology Assessment, 1988.

**Table 2-5.—U.S. Birthweight Distribution, Live Births, 1977, 1981, 1984**

	1977 <sup>a</sup>		1981 <sup>b</sup>		1984 <sup>c</sup>		Average annual percentage increase in number of births	
	Number of births (000s)	Percent of all births <sup>d</sup>	Number of births (000s)	Percent of all births <sup>d</sup>	Number of births (000s)	Percent of all births <sup>d</sup>	1977-81 <sup>e</sup>	1981-84 <sup>e</sup>
<b>Low birthweight:</b>								
<500g . . . . .	30	0.1 0/0	3.5	0.1 0/0	4.4	0.1 0/0	3.560/0	8.1 70/0
500-999g . . . . .	14.2	0.4	16.1	0.4	16.8	0.5	3.11	1.56
1,000-1,499g . . . . .	20.4	0.6	22.2	0.6	22.3	0.6	2.06	0.19
1,500-1,999g . . . . .	45.6	1.4	47.1	1.3	47.1	1.3	0.80	0.02
2,000-2,499g . . . . .	152.1	4.6	158.1	4.4	155.8	4.3	0.98	-0.04
<b>Normal birthweight:</b>								
22,500g . . . . .	3,091.3	92.90/.	3,382.0	93.20/0	3,422.7	93.30/.	2,270/.	0.40%
<b>All birthweights . . . . .</b>	<b>3,326.6</b>	<b>100.0%/0</b>	<b>3,629.2</b>	<b>100.0 %/0</b>	<b>3,669.1</b>	<b>100.0%/0</b>	<b>2,200/0</b>	<b>0.37%</b>

<sup>a</sup>U.S. Department of Health and Human Services, Public Health Service, National Center for Health Statistics, "Advance Report of Final Natality Statistics, 1984," *Monthly Vital Statistics Report*, Vol. 35, No. 4 (supplement), DHHS Pub. No. (PHS) 88-1120 (Hyattsville, MD: PHS, July 18, 1988).  
<sup>b</sup>U.S. Department of Health and Human Services, Public Health Service, National Center for Health Statistics, *Vital Statistics of the United States, 1981, Vol. 1, Natality*, DHHS Pub. No. (PHS) 85-1113 (Washington, DC: U.S. Government Printing Office, 1985).  
<sup>c</sup>U.S. Department of Health and Human Services, Public Health Service, National Center for Health Statistics, *Vital Statistics of the United States, 1977, Vol. 1, Natality*, DHHS Pub. No. (PHS) 81-1113 (Washington, DC: U.S. Government Printing Office, 1981).  
<sup>d</sup>The distribution of live births of unknown birthweight was assumed to be the same as the distribution of live births at known birthweights.  
<sup>e</sup>Percentage calculated on unrounded numbers.  
 SOURCE: Office of Technology Assessment, 1988.

period to the 1981-84 period and dramatic improvement in the rates for very low birthweight infants (those weighing between 500 and 1,500 grams), especially in the tiny newborns weighing 500 to 999 grams. The neonatal mortality rate for the very low birthweight infants in California declined more rapidly in the 1980s than it did in the late 1970s; however, very low birthweight infants make up a small proportion of all low birthweight births (see table 2-5), so the neonatal mortality rate for all low birthweight babies (i.e., those weighing more than 500 grams) declined slightly

more slowly in the early 1980s than it did in the late 1970s.

Thus, available evidence suggests that the slow-down in improvement in U.S. infant mortality in the early 1980s compared to the late 1970s is the result of both a more rapid deterioration in the U.S. birthweight distribution and, to a lesser extent, slowed improvement in U.S. birthweight-specific mortality rates.

There are no sure answers to the question of why the U.S. infant mortality rate began to level

**Table 2-6.—Changes in California's Birthweight-Specific Neonatal Mortality Rates, 1978, 1981, 1984**

	Birthweight-specific neonatal mortality rate <sup>a</sup>		1984	Percent change 1978-81	Percent change 1981-84
	1978	1981			
Low birth weight:					
500-999g . . . . .	628.79	582.06	487.92	- 7.43%	- 16.17%
1,000-1,499g . . . . .	181.55	139.15	103.99	- 23.35	- 25.27
1,500-1,999g . . . . .	48.00	35.64	36.54	- 25.76	+ 2.54
2,000-2,499g . . . . .	13.99	12.72	12.10	- 9.09	- 4.86
500-2,499g . . . . .	73.24	64.04	56.28	- 12.56	- 12.11
<b>Normal birthweight:</b>					
> 2,500g	1.91	1.67	1.47	- 12.87 0/0	- 11.95%
<b>All birthweights &gt;500g</b>	<b>6.29</b>	<b>5.25</b>	<b>4.66</b>	<b>- 16.47%</b>	<b>- 11.27 0/0</b>

<sup>a</sup>The birthweight-specific neonatal mortality rate is defined as the number of infants in a given birthweight interval who die in the first 28 days of life per 1,000 live births in that interval.

SOURCE: Office of Technology Assessment 1988, calculated from unpublished data from the Maternal and Child Health database, provided by Frost University of California, Santa Barbara, CA, August 1986, April and August 1987.

off in the early 1980s. Too little is known about how various factors—maternal, medical, and environmental—affect newborn babies' risks of dying in their first year to quantify the effects of changes in these factors on infant mortality. Yet we do know enough about the kinds of factors that matter to explore possible explanations for the slowdown. Several possible explanations are examined below.

**Changes in Birth Reporting/Increased Resuscitation of the Tiniest Newborns**

Some observers have suggested that the recent slowdown in improvement in the U.S. infant mortality rate is, at least in part, an artifact of increased reporting of live births that in the past would have been reported as fetal deaths or would have gone unreported altogether.

The basis for most States' reporting requirements is the World Health Organization's definition of a live birth. That definition classifies as a live birth "the complete expulsion or extraction from its mother of a product of conception, irrespective of the duration of pregnancy, which, after such separation, breathes or shows any other evidence of life such as beating of the heart, pulsation of the umbilical cord, or definite movement of voluntary muscles" (700). If the product of the delivery does not show any such signs of life, it is classified as a fetal death. In 43 States, fetal deaths have to be reported only if the gestational age is at least 20 weeks or if a minimum weight has been reached (755). If extremely premature

births (e.g., those with birthweights under 500 grams) are more frequently resuscitated today than they were in the late 1970s, they might be newly counted as live births instead of as fetal deaths, though their infant death rate would approach 100 percent. Counting these under-500-gram resuscitated infants as live births rather than as fetal deaths would push up neonatal and infant mortality rates because the vast majority of these tiny infants die.

Even without more aggressive resuscitation of the tiniest newborns, hospitals today may be more careful to report as live births what might have been reported as fetal deaths in the past. The reasons include increased pressure by State health authorities for complete reporting (210) as well as legal and economic considerations (755). More careful reporting of live births by hospitals also would have the effect of artificially raising U.S. neonatal and infant mortality rates. "

Since changes in birth reporting practices are difficult to assess without detailed review of hospital and vital statistics records, more indirect tests of the importance of the reporting phenomenon are necessary. National data on the distribution of live births in the United States show that from 1981 to 1984, the reported number of live births under 500 grams increased much more rapidly than the number of live births at higher birth-

<sup>a</sup>There appear to be large differences in reporting of live births among the States an observation which suggests that there is substantial room for changes in reporting practices throughout the country (755).

weights (see table 2-5). This observation suggests that reporting changes may indeed be taking place in the under-500-gram birthweight class.

The increase in reported live births at the lowest birthweights in the United States is matched by a rapid decrease in fetal death rates at the lowest weights.<sup>10</sup> The U.S. fetal death rate for weights under 1,000 grams declined much more rapidly from 1981 to 1984 (2 percent annually) than it declined from 1977 to 1981 (1/2 percent annually). If deliveries that in previous years would have been labeled fetal deaths are increasingly being labeled as live births, this labeling could account for the rapid rise in the number of very low birthweight live births.

To test how much of a difference such reporting changes could make to the U.S. infant mortality rate, OTA recalculated U.S. infant mortality rates for 1981 and 1984, making two assumptions:

- that in the two periods 1977-81 and 1981-84, the rate of change in the number of births under 500 grams was the same as the rate of change in number of births in all other low birthweight categories combined (500 to 2,500 grams); and
- that all of the "excess births" in the under-500-gram category (i. e., the difference between the number of births actually reported in the under-500-gram category and the number that would have been reported had the rate of change held constant) died in infancy.

OTA calculated that without these excess births in the under-500-gram category, the U.S. infant mortality rate in 1981 would have been 11.81 deaths per 1,000 live births in 1981 (instead of 11.9 deaths) and 10.41 deaths per 1,000 in 1984 (instead of 10.8 deaths). These recalculated infant mortality rates correspond to a compound annual rate of decrease in the U.S. infant mortality rate of 4.4 percent from 1977 to 1981 and 4.1 percent from 1981 to 1984.

Thus, much of the recent slowdown in improvement in the U.S. infant mortality rate could be accounted for by increased reporting of deliveries as live births. How much of the slowdown can

be attributed to this reporting phenomenon depends on our willingness to believe that other factors—medical or environmental—are at work to differentially increase the frequency of live births in the very lowest weight category. If, for example, sexually transmitted diseases were found to be important correlates of very premature delivery, an increase in the 1980s in the incidence of such disease among women of childbearing age could have differentially increased the number of births under 500 grams in this period—but this is simply conjecture. Currently, all that can be said is that we cannot rule out the possibility that a large part of the leveling off of improvement in the U.S. infant mortality rate in the early 1980s was an artifact of changes in birth reporting.

### Loss of **Technological Opportunities**

One possibility is that technological opportunities for improving either the U.S. birthweight distribution or birthweight-specific mortality rates that were available in the 1970s have run their course and have not been replaced by new opportunities of equal importance. Because 65 percent of all infant deaths occur in the neonatal period and 7.5 percent of neonatal deaths occur in low birthweight babies, it is useful to consider whether opportunities to improve the outcomes of low birthweight babies in the neonatal period have declined.

The 1970s saw rapid advances in technologies for treating low birthweight babies, particularly babies with respiratory distress syndrome (RDS), the most common cause of neonatal death.<sup>11</sup> Beginning in 1974, new respiratory therapy techniques and improvements in mechanical ventilation had a major impact on deaths from RDS (488,634). These respiratory technologies were first successfully applied in more mature infants with RDS. For less mature infants with RDS, it is relatively difficult for respiratory technology to compensate for undeveloped lungs, and weaning such infants from a mechanical ventilator takes longer (77,237,285). Nevertheless, recent years have seen respiratory therapy technologies increasingly applied, and with greater success, to very low birthweight newborns (665).

<sup>10</sup>The fetal death rate is defined as the ratio of fetal deaths to fetal deaths plus live births.

<sup>11</sup>Advances in technologies for treating low birthweight babies are discussed in OTA's 1987 case study on neonatal intensive care (665).

Given the history of development of neonatal respiratory therapy, it is reasonable to assume that the technology diffused in the late 1970s to moderately low birthweight babies and only later to smaller newborns. The vast majority (82 percent) of low birthweight infants are of moderately low birthweight (between 1,500 and 2,500 grams), so it is possible that the improvements in neonatal intensive care that are continuing to yield dramatic improvements in very low birthweight babies' chances of survival are statistically imperceptible because of the relatively small number of very low birthweight births. Data presented above from California support this hypothesis (see table 2-6). In California, the decline in neonatal mortality among very low birthweight babies was much higher in the 1981-84 period than it was in the 1978-81 period. But for moderately low birthweight babies, the high rate of decline in the 1978-81 period virtually evaporated in the 1981-84 period. Across all low birthweight classes, these changes translated into a modest decrease in the rate of decline in infant mortality (from 12.6 percent in the 1978-81 period to 11.9 percent in the 1981-84 period, when the birthweight distribution is held constant at the 1978 level).

Thus, it appears that in recent years the ability of new neonatal intensive care technologies to bring about dramatic improvements in U.S. infant mortality rates has declined slightly. The decline would be greater with each succeeding year as existing neonatal technology becomes ever more widely applied even among the lowest birthweight babies. This explanation for the slowdown in improvement in U.S. infant mortality rates, therefore, should become more important as time goes by. But new technologies currently under development—e.g., the use of exogenous natural or synthetic lung surfactant (207,251,304,349,422, 602,751)—may have a dramatic impact on RDS and, hence, infant mortality, in the future.

Another influence on U.S. infant mortality in the mid-1970s may have been the availability of legal abortions. Recent analyses suggest that the availability of abortions precipitated by the 1973 U.S. Supreme Court decision *Roe v. Wade* may have had an influence on the rapid decreases in U.S. neonatal and infant mortality rates in the mid-1970s (118,119,229,311). The mechanism for

this influence is probably the differential reduction of births to women at high risk for infant mortality, such as very young teenagers and unmarried women (610).

The rapid increase in the U.S. abortion ratio<sup>12</sup> beginning in 1973 would be expected to stabilize at a point when the availability of abortion providers was high enough to meet the demand for their services. At that time, the impact that abortion would have on the U.S. infant mortality rate would have already occurred, and sustaining the reduction in infant mortality in subsequent years would require new factors that may not have materialized.

Recent data suggest that the U.S. abortion ratio has indeed stabilized since 1981. Among adolescents, the percentage of pregnancies ended by abortion remained virtually unchanged between 1980 and 1982 (703). These data would suggest that the decreases in U.S. infant mortality brought about by the sudden availability of legal abortion in 1973 were largely complete by 1981.

#### Increased Poverty

The inverse relationship between infant mortality and income has been well documented (118, 176,218,229,619,757). But the ways in which poverty affects infant mortality is not well understood. Poor people may have lower rates of use of health care, higher stress, less hospitable home environments, higher rates of risky behaviors (e.g., smoking during pregnancy), fewer social supports, and more nutritional deficiencies than nonpoor people and also may exhibit racial and ethnic differences that contribute to the disparity in infant mortality between poor and nonpoor people (456,583,757). Because the causal pathways between poverty and infant mortality are not well understood, information on trends in poverty in the recent past can only be suggestive.

Since the late 1970s, the family incomes of infants in the United States deteriorated markedly. Figure 2-3 shows the percentage of infants in the United States from families with household incomes below the poverty level throughout the 1976-86 period. Whereas the average percentage

<sup>12</sup>The abortion ratio is defined as the number of abortions per 1,000 live births.

**Figure 2-3.— Percentage of U.S. Infants Under 1 Year of Age in Poverty, 1976-86**

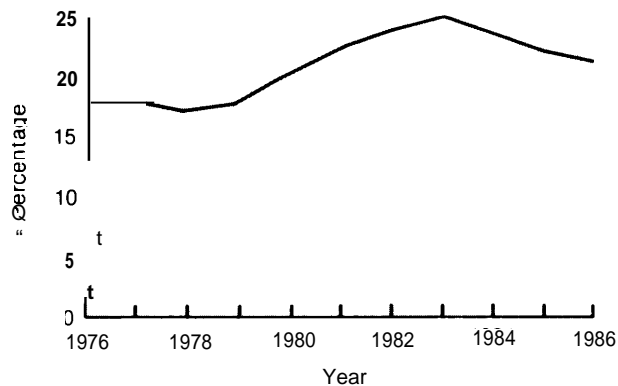

SOURCE J McNeil Bureau of the Census U S Department of Commerce. Washington, DC, personal communication, June 1987

of U.S. infants in poverty between **1976** and **1979** was 17 to 18 percent, it rose to 23.9 percent between 1981 and 1983 (419).<sup>13</sup> Since 1983, the percentage of U.S. infants in poverty has moderated, but at 21.3 percent in 1986, it was still almost 4 percentage points higher than it was in the late 1970s,

There is no way of knowing exactly how much effect the dramatic increase in the percentage of infants living in poverty in recent years has had on the U.S. infant mortality rate. Probably, however, only a modest part of the leveling off of improvement in the U.S. infant mortality rate in the early 1980s is attributable to the deterioration in living standards of infants and their mothers. One study of low birthweight in the State of Washington found that the percentage of women receiving late or no prenatal care in low-income census tracts in the State increased 34 percent and that the low birthweight rate in these census tracts increased by 18 percent between 1980 and 1982, years in which Washington State experienced an economic recession (176). The dramatic increase in the low birthweight rate in the low-income census tracts would cause a comparatively small rise in total infant mortality rates in the region,

<sup>13</sup>The percentage of children in poverty in the United States could actually be slightly higher than these data suggest. The reason is that these data categorize mothers with infants who live with parents or guardians as being within the entire household income even if they do not receive any benefit of income earned by other individuals in the household.

because poor women constitute a minority of the population.

### Changes in Pregnant Women and Children's Access to Health Services

Other chapters of this assessment summarize the evidence on the effect of health care services on the health of U.S. infants and children. The weight of the evidence supports the contention that early and appropriate use of prenatal care, combined with access to specialized perinatal services for high-risk mothers and newborns, improves birth outcomes both by raising birthweights and by improving birthweight-specific mortality rates.<sup>14</sup> In addition, delay in seeking or receiving care for infants with life-threatening conditions that respond strongly to appropriately timed medical care (e.g., infectious and respiratory diseases) may affect infant mortality rates (610).

Because poverty and unemployment reduce financial access to health care services, the inverse relationship between poverty and infant mortality may in part reflect differences in the use of appropriate services by pregnant women and children. But the impact that increases in U.S. poverty have on access to health care can be mediated by the provision of publicly funded or subsidized health services. Conversely, cutbacks in the availability of public subsidies can exacerbate the impact of poverty and unemployment on access to services.

In recent years, while the poverty rate among infants and children in this country rose, Federal spending for health care services for the poor declined. Three barometers of spending trends are the following:

1. changes in expenditures by Medicaid on behalf of poor children,
2. changes in Federal spending on maternal and child health (MCH) services, and
3. changes in Federal spending for community health centers and migrant health centers—direct Federal grant programs that provide primary health care to poor populations.<sup>15</sup>

<sup>14</sup>Prenatal care is discussed at greater length in ch. 4. Specialized perinatal services for high-risk newborns are discussed in OTA'S 1987 case study on neonatal intensive care (665).

<sup>15</sup>See ch. 3 for more detail on these programs.

Throughout the period from 1980 to 1984, the proportion of poor children eligible for Medicaid remained fairly stable. During that period, however, Federal and State Medicaid spending per child recipient of Aid to Families With Dependent Children (AFDC) in constant dollars declined, reflecting cutbacks in covered services, lower payment rates to hospitals and doctors, and increased control over the use of services (278). From 1981 to 1984, total Medicaid expenditures per AFDC child declined in constant dollars by an average of 3.1 percent annually—almost twice as fast as the decline in the 1978-81 period (see table 2-7). Total Medicaid spending on behalf of children from 1981 to 1984 declined by 5.1 percent in constant dollars for physician care and by 4.4 percent in constant dollars for prescription drugs (278).

Funding by the Federal Government for MCH programs also decreased dramatically in real terms in the early 1980s, in contrast to more gradual declines in previous years. Whereas real Federal funding for MCH services declined at an average annual rate of 6 percent between 1978 and 1981, it declined at an average annual rate of 12 percent between 1981 and 1984 (see table 2-8). Similar declines in funding for the federally supported community health and migrant health centers occurred in the period from 1981 to 1984 (see table 2-8). Trends in Federal and State funding for MCH services from 1978 to 1984 are shown in figure 2-4. Although the States' funding for MCH

services remained at approximately the same level, combined Federal and State funding for MCH services declined in constant dollars by 23.5 percent between 1981 and 1984.

The impact of reductions in publicly financed health services for pregnant women and poor children in the early 1980s when the U.S. poverty rate was rising is unknown. For both whites and blacks in the United States, the percentage of mothers who did not obtain any prenatal care or obtained late prenatal care decreased in the 1977-81 period, but the percentage increased in the 1981-84 period (see table 2-9). This observation suggests that the decline in Federal spending on health care for poor children and pregnant women in the early 1980s, coupled with a rise in poverty during that period, may have had some impact on these individuals' access to effective health care. How such changes in access may have translated into impacts on the total U.S. infant mortality rate cannot be assessed with information currently available. Their contribution is likely to have been small overall, however, because the Federal funding cutbacks affected a relatively small proportion of all pregnant women and infants.

Since 1984, the cutbacks in publicly financed health services for pregnant women and infants may have begun to moderate. The 1984 Deficit Reduction Act (Public Law 98-369) expanded Medicaid eligibility for pregnant women and children who meet the income requirements of the States, regardless of their family structure, and the Consolidated Omnibus Reconciliation Act (Public Law 99-272) gave States the option of covering all women in poverty under Medicaid.<sup>16</sup> Furthermore, several States have developed their own initiatives for delivering care to pregnant women and children in need (491). To the extent that the cutbacks in Federal programs contributed to the recent slowdown in improvement in the U.S. infant mortality rate, these new initiatives may moderate similar effects in the future.

### Changes in the Demographic Composition of Women Having Babies

OTA examined whether changes in the demographic composition of the population of women

<sup>16</sup>Recent developments pertaining to the expansion of Medicaid eligibility are discussed further in ch. 3.

**Table 2.7.—Medicaid Expenditures Per Child Recipient of Aid to Families With Dependent Children, 1978-84**

Year	Expenditures per recipient	
	Nominal expenditures	Constant 1978 dollar expenditures
1978 .....	\$322	\$322
1979 .....	\$346	\$316
1980 .....	\$384	\$316
1981 .....	\$416	\$306
1982 .....	\$416	\$278
1983 .....	\$456	\$283
1984 .....	\$477	\$279
Average annual percentage change:		
1978-81 .....	+8.90/o	- 1.6%
1981-84 .....	+4.7%	-3.1%o

SOURCE :J. F. Holahan and J.W. Cohen, *Medicaid The Tradeoff Between Cost Containment and Access to Care* (Washington DC Urban Institute Press, 1986)



**Table 2-8.—Federal Appropriations for Direct Public Health Programs, Selected Fiscal Years 1978-87**

Program	Fiscal year 1978	Fiscal year 1980	Fiscal year 1981	Fiscal year 1982	Fiscal year 1983	Fiscal year 1984	Fiscal year 1985	Fiscal year 1986	Fiscal year 1987
<b>Maternal and child health services:</b>									
Current dollars <sup>a</sup> .....	\$410.3 <sup>b</sup>	\$454.7 <sup>b</sup>	\$454.7 <sup>b</sup>	\$372.0	\$478.0 <sup>c</sup>	\$399.0	\$478.0	\$457.4	\$496.75 <sup>e</sup>
Constant 1978 dollars <sup>a</sup> .....	\$410.3	\$375.2	\$338.7	\$248.3	\$293.5	\$230.7	\$260.2	\$231.5	NA
<b>Community health centers:</b>									
Current dollars <sup>a</sup> .....	\$225.0	\$320.0	\$323.7	281.2	\$360.0	\$351.35	\$360.0	\$396.0	\$400.0
Constant 1978 dollars <sup>a</sup> .....	\$225.0	\$264.0	\$241.2	\$187.7	\$221.1	\$203.1	\$195.9	\$200.4	NA
<b>Migrant health centers:</b>									
Current dollars <sup>a</sup> .....	\$ 34.5	\$39.7	\$43.2	\$38.2	\$38.1	\$42.0	\$44.3	\$45.4	\$45.4
Constant 1978 dollars <sup>a</sup> .....	\$ 34.5	\$32.8	\$32.2	\$ 25.5	\$23.4	\$24.3	\$24.1	\$23.0	NA

a. Magee, Deputy Associate Bureau Director, Division of Maternal and Child Health, Health Services and Resources Administration, U.S. Department of Health and Human Services, personal communication, Rockville, MD, September 1987; and S. Bailey, "The Maternal and Child Health Services Block Grant, Title V of the Social Security Act," report no. S3-93 EPW, Congressional Research Service, Washington, DC, May 5, 1983.

b. Includes budgets for all programs that beginning in fiscal year 1982 were consolidated under the MCH block grant.

c. Includes \$105 million from a supplemental appropriation.

d. Includes \$1875 million from a supplemental appropriation.

e. The medical care component of the Consumer Price Index was used to calculate 1978 constant dollars.

NA = not available

9p. Conway, Budget office, Bureau of Health Care Delivery and Assistance, Health Services and Resources Administration, U.S. Department of Health and Human Services, Rockville, MD, personal communication, September 1987

SOURCE: Office of Technology Assessment, 1988

**Figure 2-4.—Estimated State and Federal Funding for Maternal and Child Health Services, 1978-84<sup>a,b</sup>**

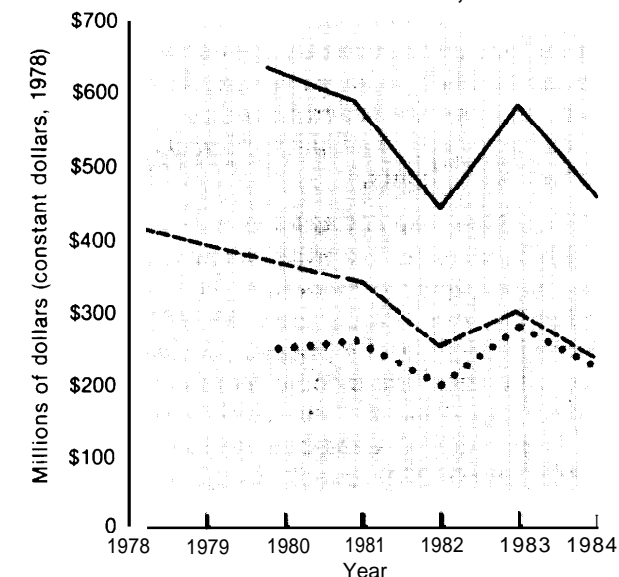

— Total (State and Federal)

---- Federal

..... State

<sup>a</sup>State funding data comparable to Federal funding data for the years 1978 and 1979 are not available.

<sup>b</sup>Estimates unavailable for 1979. Value for 1979 is based on linear interpretation between 1978 and 1980.

SOURCE: Office of Technology Assessment, 1988, based on actual Federal funding and reported data by State health agencies to the Public Health Foundation, Washington, DC

having babies could be contributing to the slowdown in improvement in U.S. infant mortality

rates. The higher rates of low birthweight and infant mortality among unmarried, black, and adolescent women raises the question of whether changes in these high-risk groups account for any part of the slowdown.

Data on the percentage of all births to women in various high-risk categories do not show any substantial differences between the pre-1981 and the post-1981 period (see table 2-10). Although the proportion of births to unmarried mothers in the United States increased over the entire 1977-84 period, the rate of increase slowed substantially beginning in 1981.

The decline in the birth rate among teenagers actually accelerated in the 1981-84 period. Data not presented in table 2-10 show that the birth rate for black unmarried women has generally declined since 1975, while the rate for white unmarried women has increased steadily. Moreover, the increases in the number of births to unmarried women in the United States since 1980 have been entirely due to increases in births to unmarried post-teenaged women (710).

Thus, it appears that if changes in the demographic composition of women having babies have had any effect, the effect would have been to accelerate the rate of progress in reducing U.S. infant mortality. Demographic changes in the composition of women having babies have not played a role in the slowdown.

**Table 2-9.— Percentage of Mothers Who Obtain Early, Late, or No Prenatal Care, by Race, 1977, 1981, 1984**

	Percentage of mothers			Annual compound rate of change	
	1977 <sup>a</sup>	1981 <sup>b</sup>	1984 <sup>c</sup>	1977-81-	1981-84
<b>Whites:</b>					
Early prenatal care <sup>d</sup> . . . . .	77.3 %	79.4 0/0	79.90/0	+ 0.7 0/0	+ 0.20'0
Late or no prenatal care <sup>e</sup> . . . . .	4.7	4.3	4.6	-0.2	+ 2.3
No prenatal care <sup>f</sup> . . . . .	1.1	1.1	1.3	0.0	+ 5.7
<b>Blacks:</b>					
Early prenatal care <sup>d</sup> . . . . .	59.00/0	62.4 0/0	61.3 0/0	+ 1.4 "0	-0.6%
Late or no prenatal care <sup>e</sup> . . . . .	9.6	9.1	10.0	- 1.3	+ 3.2
No prenatal care <sup>f</sup> . . . . .	2.8	2.8	3.4	0.0	+ 6.7

<sup>a</sup>U S Department of Health and Human Services, Public Health Service, National Center for Health Statistics, *Vital Statistics of the United States 1977 Vol I Natality*, DHHS Pub No (PHS) 81-1113 (Washington, DC: U S Government Printing Office, 1981)  
<sup>b</sup>U S Department of Health and Human Services, Public Health Service, National Center for Health Statistics, *Vital Statistics of the United States, 1981 Vol I Natality*, DHHS Pub No (PHS) 85-1113 (Washington, DC: U S Government Printing Office, 1985)  
<sup>c</sup>U S Department of Health and Human Services, Public Health Service, National Center for Health Statistics, "Advance Report of Final Natality Statistics 1984 Monthly Vital Statistics Report, vol 35, No 4, Supp DHHS Pub No (PHS) 861120, Hyattsville, MD July 18, 1986  
<sup>d</sup>Early prenatal care is prenatal care beginning within first 3 months of pregnancy  
<sup>e</sup>Late prenatal care is prenatal care beginning after 6 months of pregnancy  
<sup>f</sup>This group (mothers receiving no prenatal care) is a subset of the previous group (mothers receiving late or no prenatal care)

SOURCE: Office of Technology Assessment, 1988

**Table 2-10.— Percentage of All Births in the United States to Mothers With Selected Demographic Risk Factors, 1977, 1981, 1984**

Demographic risk factor	Percentage of all births			Average annual compound rate of change	
	1977	1981	1984	1977-81	1981-84
Unmarried . . . . .	15.5"/0	18.90/o	21.0 "/0	+5.1 0/0	+ 3.6%
Black . . . . .	16.4	16.2	16.2	-0,3	0.0
Teen (<20 years) . . . . .	17.2	14.8	13,1	-3.7	--40
Unmarried teen . . . . .	7.5	7.4	7,4	-0.3	0.0
Low education ( <12 years) . . . . .	26.2	22.9	20.9	- 3.3	- 3.0

<sup>a</sup>U S Department of Health and Human Services, Public Health Service, National Center for Health Statistics, *Vital Statistics of the United States 1977 Vol I Natality*, DHHS Pub No (PHS) 81-1113 (Washington, DC: U S Government Printing Office, 1981)  
<sup>b</sup>U S Department of Health and Human Services, Public Health Service, National Center for Health Statistics, *Vital Statistics of the United States 1981 Vol I Natality*, DHHS Pub No (PHS) 85-1113 (Washington, DC: U S Government Printing Office, 1985)  
<sup>c</sup>U S Department of Health and Human Services, Public Health Service, National Center for Health Statistics, unpublished data in preparation for *Vital Statistics of the United States 1984 Vol I Natality* (Hyattsville, MD, 1986)

SOURCE: Office of Technology Assessment, 1988

## Conclusions

Taken together, the evidence suggests that the leveling off of the U.S infant mortality rate in the early 1980s is the result of a combination of factors, each contributing to the trend in different amounts. An increase in reported live births at the birthweight interval under 500 grams clearly plays an important—and probably dominant—role in the slowdown, although the magnitude of its effect cannot be estimated with precision. Increasing resuscitation of the tiniest infants in the early 1980s, perhaps resulting from the recognition by obstetricians and neonatologists that a few of these deliveries might be salvaged and from ethical concerns arising from the “Baby Doe” controversy,<sup>17</sup> may have been responsible for greater

rates of resuscitation. Furthermore, better birth reporting and a higher rate of resuscitation may have resulted from the increasing concentration of low birthweight births in regional perinatal centers.

Other factors may also have contributed to the recent slowdown in improvement in the U.S. infant mortality rate, although available evidence suggests that their impact would be modest. These include the natural maturation of technologies for neonatal intensive care that diffused widely in the mid-1970s and that are now improving outcomes of the smallest birthweight babies; the completion of the process of diffusion of abortion services in

<sup>17</sup>Following the birth of Baby Jane Doe (an infant born with multiple birth defects), Federal regulations were written to require that

hospitals treat severely—rel>r handicapped infants over the objections of their parents. Those regulations were later declared unconstitutional by the Supreme Court

the late 1970s; and the deterioration in economic conditions and in the availability of subsidized health care services for pregnant women and children.

**The key to the slowdown puzzle appears to lie in the deteriorating U.S. birthweight distribution, most especially increasing numbers of the tiniest newborns. At present, OTA is unable to identify the reasons for the rapid increase in the frequency of reported births in the lowest birthweight categories, but the most likely explanation is the phenomenon of better birth reporting and increased resuscitation of the tiniest newborns.** If the recent slowdown in improvement in the U.S. infant mortality rate is, indeed, largely a reporting/resuscitation phenomenon, the implications

for public policy may not be very different from those that would exist if the slowdown were found to be the result of environmental or medical factors at work in the prenatal period. If very low birthweight births in the United States are just being counted more accurately, then the country has even more of a problem of infant mortality than we thought. And if extremely tiny newborns in the United States are to be increasingly resuscitated, with high costs and low probability of success, then we need to find effective methods of preventing extremely low weight births in the first place. Thus, the slowdown question may be moot; the real question is what interventions make a difference to low birthweight and, hence, infant mortality.

## CHILDREN'S HEALTH BEYOND INFANCY

The importance of infant mortality as a general indicator of children's health, coupled with the poor showing of the United States compared to other developed nations, tends to divert attention from other important dimensions of children's health, particularly in the postinfancy period. About 44 percent of deaths among children under 15 years of age in 1984 occurred in those over 1 year of age. But mortality is only one indicator of health status, and other aspects of health become increasingly important as children develop.

Unfortunately, good indicators of children's health status beyond infancy that allow monitoring of trends over time or differences among groups of children are hard to find (354,612,756). Data collected regularly through national health surveys on measures such as the prevalence of chronic conditions or self-reported health status are not easily interpreted. An increase in the prevalence of chronic conditions, for example, can be due in part to better diagnosis, increased medical access, or even medical advances that keep children alive, though chronically ill, who would otherwise have died. Changes in self-reported health status may in part reflect changes in such things as individuals' expectations about what constitutes good health (756). Even a seemingly objective indicator of children's health status (e.g.,

the number of bed-disability days per child) may be affected by changing attitudes about how childhood illnesses should be treated.<sup>18</sup>

Several key indicators of young children's health status have recently been suggested by the University of North Carolina's Child Health Outcomes Project:

- immunization status,
- prevalence of growth stunting in high-risk populations,
- elevated levels of lead in the blood, and
- non-motor-vehicle accident fatalities.

These indicators were selected by the leaders of the project because they meet a number of important conditions: 1) they are widely accepted by experts in the field as reflecting important health policy concerns, 2) they are understandable, 3) data for their assessment and monitoring are easily obtainable, 4) the indicators relate to a condition that can be prevented or greatly reduced through known and available interventions, and 5) dissemination of information about

<sup>18</sup>Furthermore, in the case of the annual National Health Interview Survey, changes in questionnaire design also make intertemporal comparisons suspect. From 1981 to 1983, the percentage of the child population reported by the survey to have activity limitations increased by 32 percent, but this increase is largely attributable to changes in questionnaire design (711).

these indicators will be likely to promote improvement in major social and health policies.

Beginning with the list of four indicators of children's health suggested by the Child Health Outcomes Project, OTA deleted one indicator (elevated blood lead levels<sup>19</sup>) and added the following two:

- total age-adjusted mortality rates, and
- mortality rates from "external" causes, including motor vehicle accidents, other accidents, and inflicted injuries.

Total age-adjusted mortality rates give a good picture of how one dimension of children's outcomes differs among groups in the population and over time. The mortality rate from "external" causes is a general index of "injury-related deaths" and reflects the difficulty that professionals have in distinguishing between injuries that are accidental and those that result from abuse or neglect.<sup>20</sup>

### Children's Mortality Rates

U.S. children's mortality rates by age of death from age 1 up to age 19 and by race are presented in table 2-11. For any given age of death from 1 to 19, children's mortality rates declined steadily from 1968 to 1984. In any given year and for both whites and blacks, children's mortality rates decline with age until ages 15 to 19, at which point they increase greatly. Among white children, mortality rates for 1.5- to 19-year-olds are considera-

bly greater than the mortality rates for the other age groups. With the exception of mortality rates for 15- to 19-year-olds (which show the differential impact of automobile accidents and suicide), mortality rates are much greater among black children than among whites.

For white children, the rate of decline in mortality rates in the 1981-84 period exceeded the rate of decline during the 1977-81 period (or the 1968-81 period for that matter) for all age groups with the exception of ages 10 to 14. For blacks, the rate of improvement in the 1981-84 period was superior to the past only for ages 1 to 4.

An examination of the causes of children's deaths in 1984 provides some understanding of the overall patterns discussed above. Leading causes of death and associated mortality rates for children up to 19 years of age are shown in table 2-12. External causes (e. g., accidents, suicide, homicide) are responsible for just 2.9 percent of all infant deaths, but this percentage increases to 43.5 percent, 51.0 percent, 57.4 percent, and 77.2 percent for ages 1 to 4, ages 5 to 9, ages 10 to 14, and ages 15 to 19, respectively.

In summary, for both white and black children in the United States, mortality rates have continued to decline for all age groups. Furthermore, with the exception of ages 10 to 14, the rates of decline for whites have generally been greater during the 1981-84 period than in the past; for blacks, with the exception of ages 1 to 4, the rates of decline have been less than the past. In 1984, black children aged 1 to 15 had a mortality rate 30- to 70-percent greater than that of whites. An examination of the causes of death indicates that external causes in general and motor vehicle acci-

<sup>19</sup>The prevalence of elevated blood levels in children is not included here because the quality of monitoring of these levels has seriously eroded since 1981 when the Federal MCH block grant enabled States to set their own public health priorities.

<sup>20</sup>See discussion of accidental injuries in ch. 7 and child maltreatment in ch. 8.

Table 2-11.—U.S. Children's Mortality Rates by Age and Race, Selected Years 1968-84

Year	Mortality rate <sup>a</sup>							
	Whites				Blacks			
	1-4	5-9	10-14	15-19	1-4	5-9	10-14	15-19
1968	78.3	41.7	38.9	102.0	151.7	61.9	58.9	149.4
1973	70.9	38.6	38.3	107.2	126.2	56.4	53.3	134.2
1977	61.1	31.4	33.4	99.6	103.2	44.4	41.9	100.1
1981	54.3	27.5	28.5	91.8	93.6	38.8	36.6	85.7
1984	46.9	23.3	27.3	81.9	78.8	36.1	34.4	77.9

<sup>a</sup>The mortality rate is defined here as the number of children in a specified age group who die per 100,000 population in that age group.

SOURCE: U.S. Department of Health and Human Services, Public Health Service, National Center for Health Statistics, unpublished data from the U.S. vital statistics, Hyattsville, MD, 1982, 1986.

Table 2-12.—Leading “Causes” of Death Among U.S. Infants and Children, 1984

Cause of death <sup>a</sup>	Mortality rate by age <sup>b</sup>				
	<1	1-4	5-9	10-14	15-19
All causes ... ..	1,086.6	51.9	25.1	28.2	81.9
Malignant neoplasms (140-208) .. . . .	3.1	4.0	3.6	3.5	4.8
Major cardiovascular disease (390-448) . . . .	29.7	2.9	1.4	1.4	2.7
Pneumonia (480-486) . . . . .	18.7	1.4	0.5	0.4	0.5
Congenital anomalies (740-759) . . . . .	234.4	6.7	1.5	1.4	1.3
Certain conditions originating in the perinatal period (760-779) . . . . .	512.4	1.0	0.1	0.0	0.0
Symptoms, signs, and ill-defined conditions (780-799) . . . . .	161.1	1.8	0.3	0.3	1.3
All other diseases (residual) . . . . .	49.3	6.6	3.1	3.2	4.6
Motor vehicle accidents (E810-E825) . . . . .	4.4	6.9	6.2	7.1	34.6
All other accidents and adverse effects (E800-E807/E826-E949) . . . . .	18.6	12.9	5.5	5.9	10.5
Suicide (E950-E959) . . . . .	—	—	0.0	1.3	<b>9.0</b>
Homicide and legal intervention (E960-E978) . . . . .	6.5	2.4	0.9	1.6	8.3
All other external causes (E980-E999) . . . . .	1.6	0.4	0.2	0.3	0.8

<sup>a</sup>The mortality rate is defined here as the number of deaths per 100,000 population in each specified group

<sup>b</sup>International Classification of Diseases code number is in parentheses

SOURCE: Office of Technology Assessment, 1988, calculated from unpublished data from the U.S. vital statistics, provided by the National Center for Health Statistics, Public Health Service US Department of Health and Human Services, Hyattsville, MD, 1986

dents in particular represent a large proportion of total deaths for both whites and blacks and for all ages beyond infancy. The continued improvement in postinfancy death rates is probably due in large part to reductions in accidental death rates during the period. Nevertheless, accidental and other injuries continue to be responsible for the majority of deaths in school-aged children.

### Children's Immunization Status

A detailed review of the most recent evidence on the immunization status of children in the United States is presented in chapter 6. In brief, the percentage of 5- and 6-year-olds who are immunized has been between 91 and 94 percent throughout the 1980s (693), very close to the national target for 1990 set by the Public Health Service (679). This high level of immunization is primarily due to the fact that all States have laws requiring proof of immunization prior to school entry (49). Reported immunization levels in licensed day care centers are also nearing the target level of 95 percent. In the school year 1985-86, according to the Licensed Day Care Center Facilities Immunization Survey, 93 percent or more of the children attending licensed day centers had had their basic immunizations (590).

In contrast, the percentage of 2-year-olds who have been immunized in the United States is well

below the 1990 target objective of 90 percent and has shown little progress since 1980. From 1979 to 1985, the percentage of children under 2 years of age who have been immunized against mumps (the lowest percentage to begin with) increased; the percentage immunized against rubella (German measles) actually declined slightly. The percentage of children under age 2 who have received polio vaccine, measles vaccine, or the combined diphtheria, tetanus, and pertussis vaccine (DTP) hardly changed (692).

The United States has significantly lower immunization rates for infants than several other industrialized countries. The percentage of fully immunized infants (0 to 1 year of age) in the United States against DTP (37.4 percent) is less than one-half the percentage in the United Kingdom (84 percent), Canada (80 percent), Sweden (94 percent, DT only), France (95 percent), Spain (97 percent), Italy (99 percent, DT only), and Israel (95 percent) (723,765).

Although it is apparent that the United States enjoys high levels of immunization overall, though not as high as they should be for very young children, considerable differences persist with respect to race and geographic location. National survey data indicate that differences exist between white and nonwhite as well as urban poverty areas and

suburban and rural areas. For example, the percentages of children immunized in central cities are substantially lower than percentages in non-central-city regions for both preschool-age and school-entry-age children. In 1985, 31 percent of preschoolers living in U.S. central cities were not adequately immunized against polio; 30 percent were not adequately immunized against mumps. Almost one-fifth of 5- to 6-year-old children living in U.S. central cities had not received three or more doses of polio vaccine, the minimally acceptable level for immunity. Nearly two-fifths of that group had not received the optimal four or more doses of polio vaccine. Many illegal aliens living in U.S. central cities have not been immunized (287).

### Growth Stunting

A high prevalence of growth stunting—the failure of a group of children to achieve a distribution of heights that conforms to standards established for a well-nourished healthy population of children—is an indicator of widespread poor nutrition or chronic infection in that population

(426). The Centers for Disease Control monitors the height of a group of low-income children in the United States. In these children, the prevalence of growth stunting (as measured by the number of children who failed to meet the fifth percentile of age-appropriate height) declined slowly, from 9.5 percent in 1976 to about 8.4 percent in 1983 (646,683).

### Conclusions

OTA's examination of young children's health status in the United States suggests that improvements have continued throughout the 1980s. Indicators of children's health, though obviously limited, show improvement throughout the 1980s for both poor and nonpoor children. Yet when data are available to compare experience in the early 1980s with that of the late 1970s, it is clear that the pace of improvement for poor children has declined. Moreover, inequalities between poor and nonpoor children and racial inequalities in children's health status have persisted throughout the period and, on some *measures* of children's health, have even worsened.

---

Chapter 3

# Children's Access to Health Care

# CONTENTS

	<i>Page</i>
<b>Introduction</b> .....	<b>53</b>
<b>Children's Use of Health Services</b> .....	<b>53</b>
<b>Children Without Health Insurance</b> .....	<b>57</b>
<b>Limitations of Private Health Insurance</b> .....	<b>59</b>
<b>Medicaid: Features That Pose Barriers Access</b> .....	<b>60</b>
<b>Eligibility Requirements</b> .....	<b>61</b>
Covered Services <b>and Limitations</b> .....	<b>62</b>
Policies Governing <b>Payment to Providers</b> .....	<b>63</b>
<b>Administrative Procedures</b> .....	<b>65</b>
Alternatives to Private and Public Health Insurance for Children .....	<b>65</b>
Maternal and Child Health Services Block Grant .....	<b>65</b>
Preventive Health and Health Services Block Grant .....	<b>66</b>
Head Start .....	<b>66</b>
Community Health Centers .....	<b>66</b>
Migrant Health Centers .....	<b>67</b>
Indian Health Service .....	<b>67</b>
Conclusions .....	<b>67</b>

## Box

<i>Box No.</i>	<i>Page</i>
<b>3-A. The Rand Corp.'s Health Insurance Study</b> .....	<b>57</b>

## Figure

<i>Figure No.</i>	<i>Page</i>
<b>3-1. Health Insurance Status of Children Under Age 13, by Income Level, united States, 1986</b> .....	<b>58</b>

## Tables

<i>Table No.</i>	<i>Page</i>
<b>3-1. Percentage of Children With a Regular Source of Medical Care and Mean Number of Medical Visits, United States, 1980</b> .....	<b>54</b>
<b>3-2. Number of Physician Contacts Per Year Per Child Under 18 Years of Age, by Family Income, United States, 1985</b> .....	<b>55</b>
<b>3-3. Number of Annual Visits to a Physician in an Ambulatory Facility by Children 0 to 17 Years of Age, by Health Status, United States, 1981</b> .....	<b>55</b>
<b>3-4. Distribution of Children's Visits to Physicians by Family Income and Site of Care, United States, 1980</b> .....	<b>56</b>



# Children's Access to Health Care

---

## INTRODUCTION

An issue of paramount importance in any discussion of children's health is whether young children have access to health care when they need it. Although most children are generally healthy, almost all need occasional treatment for acute illness and a few have chronic conditions or disabilities that require more regular care. The vast majority of Americans would probably agree that when medical care can make a difference, children should be able to obtain care regardless of their income level, insurance status, race, or place of residence (2). This chapter examines how well the United States measures up to that ideal and how Federal policies affect young children's access to health care.

How does one measure access? Two general approaches, each with limitations, are typically employed. One way is to examine differences in rates of use of services among groups of children defined by income, race, or insurance status (controlling for differences in health status). Not all differences in rates of use necessarily reflect inequities, however. If health care is bought and sold, and individual beliefs, attitudes, and preferences differ, some differences in peoples' choices are to be expected. Moreover, the choices of well-insured middle-class Americans may be distorted by an insurance system that encourages too much use of health care (507,661), so not all deviations from the patterns of use of the well-insured are necessarily undesirable.

A second way to measure access is to compare the health care that individuals actually receive with professionally defined standards of needed care. The limitation of this approach is that professional standards are sometimes overly lavish or are biased toward receipt of technical services and against receipt of information and caring. Despite the limitation of both approaches to measuring equity of access, they are the only practical methods, and both are used in this chapter.

In addition to considering children's access to health care, this chapter examines potential barriers to access. Whether a child has health insurance and the extent and quality of the insurance coverage have important implications for access. A substantial number of children in the United States have no private health insurance and are not eligible for Medicaid. This chapter discusses children's health insurance status and the adequacy of existing health insurance, both private and public, in providing children with access to medical care.

For those children who do not have health insurance, Federal programs of direct care such as the Maternal and Child Health Services block grant program, the Preventive Health and Health Services block grant, the Head Start program, community health centers (CHCs), migrant health centers (MHCs), and the Indian Health Service (IHS) are especially important. These programs are described in this chapter.

## CHILDREN'S USE OF HEALTH SERVICES

One important indicator of access to needed health services for children is the availability of a regular source of ambulatory medical care. A regular source of ambulatory care may be a private physician or group practice, a public clinic, or a hospital outpatient department—but in any event should be able either to offer a child preven-

tive and therapeutic services or to refer the child to appropriate sources for those services.

In 1980, according to the National Medical Care Utilization and Expenditure Survey (NMCUES), the vast majority (92 percent) of children 18 years old and under had a regular source of medical care

(86) (see table 3-1). NMCUES data are based on respondents' self reports, however, so some "regular sources of care" may be emergency rooms or other settings that most experts would agree are inadequate and costly sources of regular care for children. Family income made a difference in the percentage of children with a regular source of care, although the differences were not dramatic (about 85 percent of children with family incomes below the Federal poverty level had a regular source of care v. 94 percent of those with incomes more than twice the poverty level), Race/ethnicity also made a difference in the percentage of children with a regular source of care in 1980, although again the differences were not large (94 percent of white children had a regular source of care v. 86 percent of black children and 85 percent of Hispanic children).

Even though NMCUES did not find large income-related or racially related differences in the number of children with a regular source of care in 1980, it did find large differences in the annual number of medical visits by children classified by family income and race/ethnicity (see table 3-1). Children whose family incomes were below the Federal poverty level in 1980 had virtually the same average number of medical visits as children with family incomes at least twice the Federal poverty level (3.6 visits per year). On the other hand, children whose family incomes were just above the poverty level—the near poor—had substantially fewer visits per year (2.6 visits per year) than children living in poverty, about one-half of whom were covered by Medicaid.

NMCUES found striking differences in the number of medical visits by children classified by race/ethnicity in 1980 (3.7 medical visits for white children v. 2.1 visits for blacks and 2.4 visits for Hispanics). Much of the difference by race/ethnicity can probably be explained by the correlation of race/ethnicity with family income and place of residence. Some of it may be explained by the possible correlation of race/ethnicity with other factors that affect parents' attitudes about seeking medical care (e. g., family size).

<sup>a</sup>The Federal poverty level in 1980 was \$8,385 for a family of four (382). The 1987 Federal poverty level for a family of four is \$11,203 (382).

**Table 3-1.—Percentage of Children With a Regular Source of Medical Care and Mean Number of Medical Visits, United States, 1980<sup>a</sup>**

	Regular source of care		Number of medical visits	
	Yes (%)	SE <sup>b</sup>	Mean	Mean SE <sup>b</sup>
Target population				
All children 0-18 yrs.	91.9	0.7	3.3	0.1
Age (yr):				
0-2	94.1	0.9	5.3	0.1
3-5	92.8	1.2	3.3	0.2
6-11	92.5	1.0	2.6	0.1
12-18	90.3	1.0	3.1	0.1
Race/ethnicity:				
White	94.0	0.7	3.7	0.1
Black	86.0	2.3	2.1	0.1
Hispanic	84.7	3.0	2.4	0.2
Family income level <sup>c</sup>				
<100%	85.3	2.4	3.3	0.2
100-150%	<b>90.7</b>	1.3	2.6	0.2
150-200%	89.6	2.3	3.0	0.2
>200%	94.3	0.7	3.6	0.1
Region:				
Northeast	93.8	1.0	3.6	0.2
North central	96.3	0.9	3.5	0.1
South	89.7	1.4	3.0	0.2
West	88.1	1.6	3.4	0.2
Population density:				
SMSA <sup>d</sup> central city	88.9	1.6	3.0	0.1
SMSA <sup>d</sup> non-central city	93.6	1.0	3.7	0.2
Urban non-SMSA	91.6	2.1	3.3	0.2
Rural	93.2	1.8	3.1	0.3

<sup>a</sup>Data from the National Medical Care Utilization and Expenditure Survey (NMCUES).

<sup>b</sup>SE standard error of estimate

<sup>c</sup>Family income levels are defined as the family's standing relative to the 1980 poverty line

<sup>d</sup>SMSA Standard Metropolitan Statistical Area

SOURCE J. A. Butler, W. D. Winter, J. D. Singer et al. Medical Care Use and Expenditure Among Children and Youth in the United States: Analysis of a National Probability Sample. *Pediatrics* 76(4):495-507, 1985

Data from the National Health Interview Survey for the years 1982 to 1985 suggest that family-income-based differences in the percentage of children who have at least one contact with a physician in the course of a given year have remained fairly stable in the recent past (711,711a). In 1985, children from families with low incomes had fewer contacts with physicians per child than did children from families with high incomes (see table 3-2),

An analysis of data from the Child Health Supplement of the 1981 National Health Interview Survey indicates that income-based differences in the use of physicians' services are especially pronounced among children who have health prob-

**Table 3-2.— Number of Physician Contacts Per Year Per Child Under 18 Years of Age, by Family Income, United States, 1985**

Family income	Number of contacts by-place of contact					
	Telephone contact	Office visit	Hospital visit	Other visit	All visits	All places
Under \$10,000	0.5	1.9	0.9	0.6	3.4	3.8
\$10,000 - \$19,999	0.7	2.0	0.8	0.5	3.3	3.9
\$20,000 - \$34,999	0.8	2.7	0.4	0.5	3.6	4.4
\$35,000 or more	0.9	3.1	0.5	0.4	4.0	5.0

SOURCE: U.S. Department of Health and Human Services, Public Health Service, National Center for Health Statistics. Current Estimates From the National Health Interview Survey, U.S. 1985 Vital and Health Statistics Series 10, No. 160 (Washington, DC: U.S. Government Printing Office, 1986).

lems (458). In 1981, as shown in table 3-3, healthy children from families with low incomes (under \$10,000) had at least as many physician visits as healthy children with higher family incomes. But among children suffering from health problems in 1981, those from families with low incomes made fewer physician visits than those from families with higher incomes.

Efforts to interpret income-related and other demographic differences in children's use of medical care are impeded by a lack of clear evidence about how medical care use affects health outcomes. For children in the first 2 years of life, however, several immunizations and developmental assessments are recommended by the American Academy of Pediatrics and others (17,690).<sup>2</sup> In light of these recommendations, low levels of medical care use are more telling for children under 2 years old than for older children. According to NMCUES, 8 percent of all children under age 2 in 1980 had had no medical visit in the previous year (86). Among children from families of different family-income levels, the breakdown was

<sup>2</sup>Information on the recommended frequency and content of well-child care, as well as the effectiveness of such care, is provided in chapter 6.

as follows: 13 percent of children with family incomes between 100 and 150 percent of the poverty level (the near poor) had had no medical visit; 10 percent of children with family incomes below the poverty line had had no medical visit; and only 6 percent of children with family incomes of more than twice the poverty level had had no medical visit.

In addition to family income, a child's insurance status is a critical determinant of the use of medical services. According to NMCUES, almost 18 percent of children under 2 years of age without insurance coverage in 1980 (who are heavily concentrated among the poor and near poor) had had no medical visit in the previous year (86).

The poorest children are likely to be eligible for Medicaid, and these children have higher rates of use of some health care services than do near-poor children with family incomes that exceed Medicaid eligibility standards. An analysis of NMCUES data for 1980 found that children with Medicaid had as many general checkups and immunizations as middle-income privately insured children (except for middle-income children enrolled in health maintenance organizations) (45). Among children

**Table 3-3.— Number of Annual Visits to a Physician in an Ambulatory Facility by Children 0 to 17 Years of Age, by Health Status, United States, 1981<sup>a</sup>**

Family income	Average number of annual visits to a physician		
	All children 0 to 17 years of age	For children in good or excellent health	For children in fair or poor health
Low income <sup>b</sup>	4.5	4.1	9.6
Middle income <sup>c</sup>	4.2	3.9	12.3
High income <sup>d</sup>	4.2	4.0	12.4

<sup>a</sup>Data from the National Health Interview Survey, 1981 Child Health Supplement.

<sup>b</sup>Family income of less than \$10,000.

<sup>c</sup>Family income of \$10,000 to \$24,999.

<sup>d</sup>Family income of \$25,000 or more.

SOURCE: P. W. Newacheck and D. Halperin, "Access to Ambulatory Care Services for Economically Disadvantaged Children," *Pediatrics* 78(5): 813-819, 1986.

whose family incomes were under \$10,000, those with health problems who were covered by Medicaid visited a physician more often than did those with health problems who were not covered (458). Even so, children with health problems who are covered by Medicaid do not visit physicians as frequently as children with health problems from higher income families (458).

A child's family income and insurance status affect not only the frequency of medical visits, but also the site of ambulatory care. In 1980, according to NMCUES, visits to emergency rooms, outpatient departments, and health clinics accounted for a much larger share of visits to physicians made by children with family incomes under \$10,000 than by children with higher family incomes (see table 3-4). Although children from low-income families with no insurance had the lowest levels of use of physicians' services, they received more of their care in physicians' offices than did children covered by Medicaid.

For children who have health insurance, the characteristics of their insurance plans are important determinants of the number and kinds of visits children make to health care providers. Insurance plans vary with respect to covered benefits, requirements for deductibles and copayments, utilization controls or limits enforced by the plan, provider payment levels, and administrative procedures. Although there is little direct evidence relating particular characteristics of insurance plans to children's use of health services, a landmark study of almost 6,000 people by the Rand

Corp. showed that the structure of a health insurance plan can be a powerful influence on children's use of medical care (370) (see box 3-A).

To summarize, the evidence presented in this section points to a consistent relationship between family income and the use of ambulatory medical care for children—a relationship that appears to be stronger for sicker children. Because this relationship is mediated by the availability of health insurance coverage, however, very poor children who have access to Medicaid are more similar to affluent children in their frequency of use of services than are low-income uninsured children. Low-income children without Medicaid or private health insurance tend to use ambulatory health services less frequently than any other children.

Although children covered by Medicaid tend to use health services more frequently than low-income children without insurance, the settings in which these two groups of children receive care are far more like one another than like settings used by children from higher income families. In comparison to nonpoor children, children with Medicaid receive a greater percentage of their ambulatory care in emergency rooms, outpatient departments, and clinics and a smaller percentage in physicians' offices.

The Rand health insurance experiment showed that the structure of health insurance can have dramatic effects on children's use of medical care. Although Medicaid children are not subject to co-

**Table 3-4.—Distribution of Children's Visits to Physicians by Family Income and Site of Care, United States, 1980**

	Total number of visits		Percentage distribution of visits by site of visit <sup>a,c</sup>				
	in thousands	All places	Physician office	Health center or clinic <sup>b</sup>	Emergency room	Outpatient department	Other <sup>d</sup>
All children . . . . .	199,911	100.00/0	66.8%	9.3%	10.0%	10.4%	3.5%
Children with family income > \$10,000 . . . . .	154,120	100.0	71.9	8.4	8.7	7.3	3.6
Children with family income <\$10,000 . . . . .	45,791	100.0	49.5	12.2	14.3	20.8	3.2
Medicaid . . . . .	22,649	100.0	50.4	15.1	15.9	15.3	3.2
Private insurance . . . . .	18,255	100.0	45.5	9.1	12.5	29.4	3.2
No insurance . . . . .	4,887	100.0	59.0	10.7	13.5	13.7	3.1

<sup>a</sup>Excludes telephone contacts

<sup>b</sup>Includes visits to community health centers and school clinics

<sup>c</sup>Includes laboratory and home visits as well as visits to unspecified places

<sup>d</sup>Includes all children with at least one ambulatory visit

SOURCE: U.S. Department of Health and Human Services, Public Health Service, National Center for Health Statistics, National Medical Care Utilization and Expenditure Survey, Hyattsville, MD, 1980.

### Box 3-A.—The Rand Corp.'s Health Insurance Study

Families participating in the Rand Corp.'s health insurance experiment were randomly assigned to one of five different health insurance plans that varied along two dimensions: 1) the coinsurance rate (fraction of the medical bill paid by the family); and 2) the maximum annual dollar expenditure (an income-related upper limit on the family's out-of-pocket expenditures). Data on health expenditures, use of health services, and health status were collected throughout a 5-year period (370).

The coinsurance rate varied among plans from 0 to 95 percent, and Rand researchers found a consistent relationship between the coinsurance rate and children's use of services (370). Among children under age 5, the researchers found, 95 percent of those with no coinsurance (i.e., free care) used ambulatory care services in the course of a year; among children with a 95-percent coinsurance rate, only 82 percent used ambulatory services. As the coinsurance rates increased, the annual number of episodes of treatment for children under age 5 decreased regularly—from 4.4 episodes for children with free care to 2.6 episodes for children with the 95-percent coinsurance rate (370).

The Rand researchers also investigated how increasing coinsurance rates affected the use of medical care judged by the researchers to be highly effective for specified conditions (383). They found that—especially among poor children<sup>1</sup>—cost-sharing substantially reduced the number of episodes of care for conditions for which medical care is highly effective. Poor children had only 56 percent as many episodes of care for these conditions under cost-sharing plans as they had under a free plan. Children with higher family incomes had 85 percent as many episodes of care under cost-sharing plans as they had under a free plan, but the difference was not statistically significant. Interestingly, Rand researchers also found that poor and nonpoor children used medical care that the researchers judged to be rarely effective less frequently under cost-sharing plans than under a free plan, and the reduction in frequency was about the same order of magnitude as the highly effective medical care. This finding suggests that while cost-sharing reduces children's use of health care, parents are not particularly good at discriminating between necessary and unnecessary use.

<sup>1</sup>Poor children were defined in the Rand study as those whose family income was at or below the 33rd percentile of the income distribution, or \$20,200 for a family of four (383).

insurance requirements, other characteristics of the Medicaid program may be important in explaining the observed differences in frequency of visits and settings of care for these children. A

later section in this chapter will discuss elements of the Medicaid program, particularly aspects of its implementation, that may be important influences.

## CHILDREN WITHOUT HEALTH INSURANCE

The health insurance status of American children can be estimated from various national surveys. One of these is the U.S. Census Bureau's Current Population Survey. That survey has asked about health insurance coverage every March since 1979 and therefore gives a consistent and timely picture.<sup>3</sup>

<sup>3</sup>Other national surveys that provide information on health insurance status include the National Health Interview Survey, the National Medical Care Expenditure Survey of 1977, and the National Medical Care Utilization and Expenditure Survey of 1980.

An analysis of the Current Population Survey shows that 63 percent (about 28 million) of the nearly 45 million children under age 13 in 1986 were reported to be covered by private health in-

The estimated rates of insuredness provided by these surveys differ slightly from those of the Current Population Survey (630). The strengths and weaknesses of the Current Population Survey relative to these surveys are discussed in K. Swartz, "A Note on the Strengths and Weaknesses of Using the CPS To Estimate Children's Health Insurance Coverage," OTA background paper, to be available from the National Technical Information Service, Springfield, VA.

insurance, including parents' employer-based group health plans and policies purchased directly by the family (632).<sup>4</sup> An additional 16 percent of children under age 13 (about 28 million children) were covered under a public health insurance plan—most of them by Medicaid but a few by Medicare<sup>5</sup> and the Civilian Health and Medical Program of the Uniformed Services, the insurance program for dependents of military personnel. Another 3 percent (just under 2 million) were covered by a combination of public and private health insurance.

As shown in figure 3-1, poor children and near-poor children (those with family incomes between 100 and 150 percent of the poverty level) are more likely to be uninsured than more affluent children are. In 1986, 61 percent of all children under age 13 who were reported to be uninsured by the Current Population Survey were from either poor or near-poor families (632).

The Current Population Survey overestimates the population of children without health insurance, because it does not directly ask about whether children have health insurance coverage through a noncustodial parent; consequently, children who are covered by a private policy bought by a noncustodial parent are incorrectly listed as uninsured. Although it is impossible to precisely adjust the estimates to correct for the Current Population Survey's upward bias, OTA estimates that the true percentage of children under 13 years old who were without health insurance in 1986 was somewhere in the range of 14 to 19 percent.<sup>b</sup> Those percentages translate to between 6.26 and 8.5 million uninsured children.

Data from the Current Population Survey indicate that there has been no progress in addressing the problem of a lack of health insurance among children in recent years.<sup>7</sup> In 1980, the per-

<sup>4</sup>Self-purchased insurance is generally a great deal more expensive to the family than employer-based group health policies offering coverage of employees' dependents and covers only about 6 percent of all privately insured children (185).

<sup>5</sup>Children eligible for Medicare include those with end-stage renal disease and those who meet the Medicare criteria for blind and disabled.

<sup>6</sup>See app. D for the method used to calculate this range.

<sup>7</sup>The upward bias in the Current Population Survey's estimate of the number of uninsured children should not appreciably affect comparisons across years.

Figure 3-1.— Health Insurance Status of Children Under Age 13, by Income Level, United States, 1986<sup>a</sup>

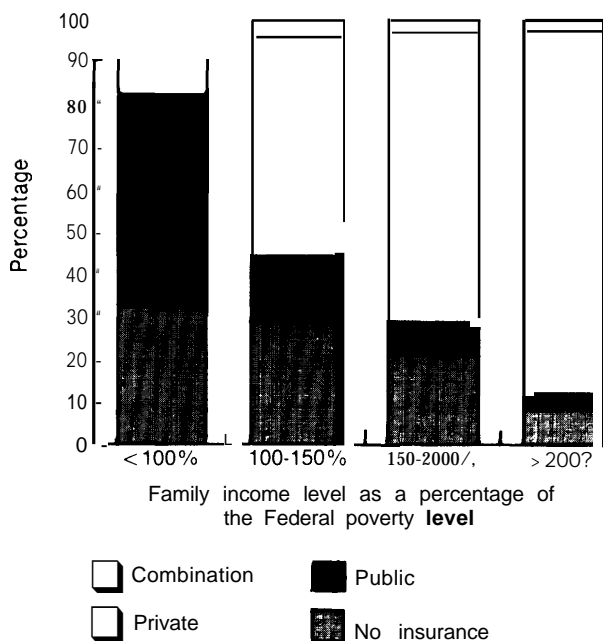

<sup>a</sup>This figure is based on data from the Current Population Survey. Because that survey does not reflect insurance held by noncustodial parents, the percentage of children without health insurance—especially the percentage of children from higher income families—is probably overestimated.

SOURCE Office of Technology Assessment, 1988, based on K Swartz, Urban Institute, statistical analysis of the Bureau of the Census' Current Population Survey, 1988, prepared for the Office of Technology Assessment, U.S. Congress, Washington, DC, 1988.

centage of children under age 13 who were reported to be uninsured was 17 percent; by 1984, the rate had increased to 18 percent (632); and by 1986, it was 19 percent.

What does it mean to be without health insurance of any kind? Lack of health insurance coverage exposes family members to a small risk of catastrophic health care expenses beyond the resources of all but the wealthiest of American families. In 1980, about 300,000 noninstitutionalized children 0 to 18 years of age (0.36 percent) incurred out-of-pocket medical expenses above \$2,000 (417). If a child's catastrophic expenses involve long-term disability and institutionalization, eligibility for Medicaid may reduce the family's financial exposure.<sup>8</sup> In some circumstances, the

<sup>8</sup>To the extent that catastrophic medical expenses are incurred in institutions, some children can become eligible for Medicaid under

rules for Medicaid coverage may encourage the keeping of children in hospitals who could be cared for at home.<sup>8</sup> If a child's catastrophic ex-

penses do not involve institutionalization, the family must spend itself into poverty to be eligible for Medicaid.

the Federal Supplemental Security Income (SSI) program To be eligible for SSI, a child must have a disability that is expected to last at least a year (or until death) and must have income and resources that do not exceed established limits. By statute, the income of parents must be deemed available to a child in this category if the child is living in the same household as the parents. After 1 month in an institution, however, a child is no longer considered to be living in the family household, and the parents' income and resources are irrelevant to the eligibility determination. (See Sec. 1614(f) of the Social Security Act.)

Technology-dependent children, those requiring the use of a medical device to compensate for the loss of use of a body function and substantial and complex daily nursing care to avert death or further disability, are striking examples of children with such catastrophic expenses. See OTA's technical memorandum *Technology-Dependent Children (664)* for a discussion of the Medicaid coverage issues.

In the absence of Medicaid coverage, the families of uninsured children with high expenses relative to their incomes may receive free care or care provided at a substantial discount from providers' usual charges. Such care may be funded by public programs, such as State or local maternal and child health agencies (funded in large part by Federal grants), private philanthropic agencies, or health care providers. Thus, direct public and private funding of health care and uncompensated care fills the gap between the care a child receives and the care that is paid for by insurance or families themselves.

## LIMITATIONS OF PRIVATE HEALTH INSURANCE

The fact that a child is covered by a private health insurance policy does not necessarily imply that the insurance provides adequate coverage, especially for catastrophic expenses. The extent to which a child's family is exposed to out-of-pocket expenses for health care depends on five components of the insurance plan:

1. *limits on covered services*—limits on the type or number of insured services, such as preventive visits, home care, or maximum number of hospital days;
2. *first dollar deductible*—the amount (which may vary by type of benefit) that the beneficiary must pay each year before he or she is eligible for coverage;
3. *coinsurance rate*—the percentage of the cost of covered services for which the beneficiary is responsible;
4. *catastrophic stop-loss on out-of-pocket expenses*—typically an annual upper limit on the beneficiary's out-of-pocket payments for insured services; and
5. *overall plan maximums*—limits on the total amount the insurer will pay out on the policy, calculated either as annual, per episode, or lifetime limits:

Exposure to catastrophic health care expenses depends largely on features four and five: the cata-

strophic stop-loss coverage and overall plan maximum.

The most recent population-based survey of insurance coverage, the 1977 National Medical Care Expenditure Survey, found that about 50 million children under 18 years of age had private health insurance. About 41 million (84 percent) of the children with private insurance had major medical coverage rather than basic benefit plans.<sup>10</sup> Less than one-quarter (23 percent) of the children with major medical coverage in 1977 had overall lifetime plan maximums that exceeded \$250,000 (165).

In the decade since 1977, private health insurance has undergone major changes in all of the components listed above. Since there has been no population-based survey of insurance coverage, however, the best recent evidence available on private insurance coverage is from surveys of employer-based private-sector group health plans.

<sup>10</sup>Major medical coverage provides for an array of services and usually includes an annual deductible, coinsurance requirements, and maximum benefit limits. By comparison, basic benefit plans usually provide first-dollar coverage but cover only a very narrow set of services (e. g., hospital, surgical).

These surveys indicate that as of 1984, over three-fourths of all employer-based private-sector plans (and employees) were subject to some kind of overall plan maximum; more than half of all employees had policies with lifetime maximum limits of \$500,000 or less (105,185,271,718,768).<sup>11</sup> Although data on new group health insurance policies written by insurance companies in 1984 show a dramatic trend toward higher overall lifetime maximum limits (263), this trend will change the averages very gradually.

The situation is somewhat better with respect to catastrophic stop-loss coverage. In 1984, more than three-fourths of employer-sponsored group plans and employees had an annual catastrophic limit on out-of-pocket expenses. Catastrophic limits function only up to the maximum benefit limits of the policies. Furthermore, since catastrophic limits refer only to benefits covered under the policy, coverage of catastrophic expenses depends in part on the benefit limitations.

<sup>11</sup>FOX and Yoshpe reported in 1986 that 67 percent of plans had maximums and that less than 20 percent of plans had lifetime maximums under \$500,000 (185). They surveyed a small number (60) of employers, however, and their sample may have been biased because it was drawn from a data source listing firms with net asset values above a specific threshold, suggesting that even the smaller firms in the sample are disproportionately wealthy (185).

Benefit limitations can put a family at risk for expenses even when catastrophic stop-loss coverage exists and can also discourage families from seeking care in settings that are not covered under their insurance policies. In 1984, for example, almost one-half of employees in medium and large business establishments were without any home health care benefits (718). Although home health benefits have been introduced increasingly in the recent past—between 1980 and 1982, for example, 11 percent of employer-based plans in a survey of large firms reported adding such benefits (105)—it appears that many children would not be eligible for home health benefits under their current plans.

Little is known about the extent to which private insurance covers preventive health services, such as health supervision visits or immunizations, for children. Experts agree that coverage of preventive services is infrequently offered. Even when such coverage is included in the benefit package, however, the nearly universal existence of first-dollar deductible requirements limits the effective coverage for these services.

<sup>12</sup>About 90 percent of all employer-based private health plans have deductibles of \$100 or more (768).

## MEDICAID: FEATURES THAT POSE BARRIERS TO ACCESS

Medicaid is a federally aided, State-administered program that provides medical assistance to an estimated 23 million low-income people (106). Operating within Federal guidelines, each State designs and administers its own Medicaid program. Thus, Medicaid eligibility requirements, services offered, and methods and levels of payment to providers vary widely among the States. The adequacy of Medicaid in ensuring access to health care for poor children and other eligible people depends on these State-specific features. At least 50 percent of each State's Medicaid expenditures are paid by the Federal Government using State-specific matching formulas (106). Overall, the Federal contribution in fiscal year 1987 will be about 54 percent of the total national Medicaid expenditure of \$48.2 billion (465).

For children who are eligible for Medicaid, some federally mandated components of the program facilitate access to health care. States are required to include as benefits to their eligible populations a range of services including nursing home and home care, as well as hospital, physician, and laboratory and X-ray services. Furthermore, Medicaid is unique in its commitment to preventive health care for children through the Early and Periodic Screening, Diagnosis, and Treatment (EPSDT) program. EPSDT is a program that combines informing, outreach, health screening, followup care for detected conditions, and case management. Each State is required to offer EPSDT services to all Medicaid-eligible children and youth under 21. Medicaid children pay no coinsurance for services received and, except



in States with recently initiated waiver programs, are free to choose their provider (subject, of course, to the willingness of the provider to serve them).

Despite the features of Medicaid that encourage access, the access that poor children actually have to health care services is limited by powerful barriers imposed through both Federal requirements and State decisions. These barriers work through four features of Medicaid:

1. eligibility requirements,
2. covered services and limitations,
3. policies governing payment to health care providers, and
4. administrative practices.

The barriers in each of these areas are discussed in turn below.

### Eligibility Requirements

Eligibility for Medicaid is mandated by Federal statute for some groups of people and is at the option of the State for others. In general, Congress has been expanding Medicaid eligibility for children since 1984. Today, therefore, all children up to 3½ years old whose family incomes fall within the State limits for Aid to Families With Dependent Children (AFDC)—even though they may not be eligible for AFDC because of their family structure or parent's employment status—are entitled to Medicaid. By July 1988, as mandated by the Omnibus Reconciliation Act of 1987 (OBRA-87) (Public Law 100-203), Medicaid eligibility will have been extended to all children through age 6 whose family incomes and resources fall within AFDC limits.

Eligibility for Medicaid among young children varies a great deal among the States because need and payment standards for the AFDC program are determined by individual States. In 1985, the State AFDC eligibility levels for a family of three ranged from 16 to 97 percent of the Federal poverty level, with a median of 45 percent (104). Thus, although Medicaid eligibility for very young children no longer depends on categorical criteria such as disability or an absent parent, the income and resource criteria underlying eligibility are still varied, and, in many States, stringent. In 1986,

less than half of all children under 13 years of age living in poverty were covered by Medicaid.<sup>13</sup>

Older children and children in families with incomes above AFDC eligibility levels are eligible for Medicaid only if they either fall into a category mandated by Federal law or meet criteria for coverage under an optional State-specific program. Under Federal law, children under 21 are "categorically" eligible for Medicaid if they are eligible for AFDC, are in foster care under Title IV-E of the Social Security Act, or are blind or disabled and eligible for Supplemental Security Income. States have the option to offer Medicaid to children of families that are eligible for AFDC but are not receiving it; in 1986, 26 States exercised this option (674). States also have the option to offer Medicaid to "medically needy" children who would be categorically eligible for Medicaid but whose income and resources lie above the AFDC need standards. Each State has a right to designate its own medical, need, income and resource standards, but a State's medically needy standards cannot exceed 133 percent of the State's AFDC income and resource standards. Thus, even in States that offer medically needy programs—35 States in 1986 (674)—Medicaid eligibility under these programs varies with AFDC standards.

OBRA-87, passed in December 1987, gave States the authority to expand Medicaid eligibility, beginning in July 1988, to all children through 8 years of age whose family incomes are below the Federal poverty level and to infants whose family incomes are less than 185 percent of the Federal poverty level. 14 Individual States can choose any income standard they want provided it is below the poverty line. Furthermore, individual States need not extend Medicaid coverage all the way through 8 years of age. If a State chooses to cover pregnant women, however, it must cover children at least up to the age of 2, and vice versa. For poor children's access to health care, the new authority granted to the States by OBRA-87 is a

<sup>13</sup>According to the 1986 Current Population Survey, 49 percent of all children under 13 years of age in poverty were covered by Medicaid, Medicare, or the Civilian Health and Medical Program of the Uniformed Services (632).

<sup>14</sup>The 1987 Federal poverty level is \$11,203 for a family of four (382).

major breakthrough. The availability of this optional coverage, however, will probably increase the variation among States in Medicaid coverage for children.

## Covered Services and Limitations

States are required by Federal law to offer inpatient and outpatient hospital services, physician services, EPSDT for children under 21, family planning services and supplies, and a wide range of other services<sup>15</sup> to “categorically needy” Medicaid recipients; and they may choose to provide preventive services and any of a number of other optional services.<sup>16</sup> At the same time, however, States can and do establish limitations on the frequency and number of services.

States may also construct special programs that target a specific and more limited package of services to a particular group of “medically needy” persons. State medically needy programs are required by Federal law to provide ambulatory services to children under age 18 and prenatal and delivery services to pregnant women (184). Virtually all States with programs covering medically needy children have provided the same range of benefits available to children who are categorically needy (184).

Since 1981, States have had the option of applying for waivers to provide a wide range of community-based services necessary to keep people who would otherwise be institutionalized in their homes. Some States have used these waivers to provide services to chronically ill children who would be in institutions (664).

Although the list of Medicaid-covered services appears to be comprehensive, particularly if a State offers many of the optional services, individual States have imposed limits on the availability of covered services through a variety of

regulations governing the frequency and settings of use.<sup>17</sup> These limitations have been imposed for the purpose of controlling Medicaid outlays. To the extent that they reduce unnecessary use of services, limitations on the frequency and settings of use of services do not constitute barriers to access. As discussed below, however, the limitations are often rigidly designed and enforced, and thus are likely to pose problems for some children.

States have used a variety of mechanisms to control the use of hospitals by Medicaid recipients. Two particularly important ones are limits on the length of hospital stay or total number of days of care covered annually. In 1986, 11 States limited the number of days of hospital care for which they would pay (674). For some children, such as premature babies needing neonatal intensive care or chronically ill technology-dependent children requiring 24-hour ventilator assistance, these limitations on days of care are extremely restrictive (664). An analysis of the effects of inpatient controls on hospitalization rates for Medicaid children in 1980 did not find significant effects for any specific individual controls (413); that study, however, did not take account of the fact that hospital use may be restricted through a combination of control strategies.

Some States restrict visits to physicians by Medicaid recipients. In 1986, 12 States imposed some ceiling on the annual number of ambulatory care visits allowed to Medicaid recipients, ranging from 2 to 36 ambulatory visits per year (674). State limitations on ambulatory visits do not apply to visits under Medicaid’s EPSDT program. Thus, for a child who has been screened under EPSDT and found to be in need of treatment, the limitations do not apply.

Finally, many States limit the use of services by denying coverage of certain procedures. At present, for example, most States do not reimburse for tocodynamometry—the use of an ambulatory monitoring device to detect premature onset of labor in pregnant women. (See app. F.) Refusals to cover specific procedures are not nec-

<sup>15</sup>Other required services include laboratory and X-ray procedures, skilled nursing facilities for persons over 21, home health care services for those entitled to skilled nursing care, rural health clinic services, and nurse midwife services.

<sup>16</sup>Optional services include clinic services; drugs; intermediate care facilities; eyeglasses; skilled nursing facilities for those under 21; rehabilitative services; prosthetic devices; private duty nursing; inpatient psychiatric care for children or the elderly; and physical, occupational, and speech therapies.

<sup>17</sup>The availability of Medicaid-covered services has also been curtailed by restrictions on the methods and level of payment of providers. Medicaid payment policies are discussed in a subsequent section of this chapter.

essarily indicators of poor access to needed services. To the extent that evidence about the effectiveness of a service is unfavorable or unavailable, a State may have good reason to deny coverage for that service. There have been no studies of differences between Medicaid children and non-Medicaid children in rates of use of procedures for which there is a consensus among medical experts regarding the procedure's usefulness.

### **Policies Governing Payment to Providers**

Throughout the history of Medicaid, States have attempted to control expenditures by controlling the methods and rates of payment for services delivered to Medicaid patients. States have always had wide latitude in determining the method and levels of payment for physicians' services, and in the early and mid-1970s, a number of States, including most States with large Medicaid populations, began to control payments to physicians (278). The trend toward greater control of physician payment has intensified since 1981 (278). Hospital inpatient care, on the other hand, became a serious target for payment control only with the passage of the Omnibus Reconciliation Act of 1981 (OBRA-81) (Public Law 97-3.5). Before then, most States followed Medicare's retrospective cost-based reimbursement system, largely because of administrative barriers to the development of an alternative payment method (278). OBRA-81 broadened States' latitude to deviate from Medicare's principles of reimbursement for hospital care, and States have since taken new initiatives to control payment for inpatient services. Recent State initiatives to control hospital inpatient payment and physician payment and the implications of these initiatives for children's access to care are described in greater detail below.

#### **Physician Payment Controls**

Physician fees have always been subject to limitations under Medicaid (278). The Federal Government, by never imposing a specific method of payment for physicians, has allowed States to experiment with alternative approaches to limiting expenditures for physicians' services. Although

most States began with a system based on charge screens similar to Medicare's "customary, prevailing, and reasonable" system, by 1986, 35 States had adopted fee schedules for physicians (674). Several of the other States have stopped regularly updating their charge screens, and so their fees have become tighter over time.

In general, Medicaid fees for physicians lie well below those paid by Medicare, which are in turn lower than those paid by the private sector. In 1979, for example, 30 States paid physicians Medicaid fees that were only 90 percent (or less) of Medicare fees, and only 3 States paid fees higher than Medicare fees (277). Since 1979, the level of Medicaid fees relative to private fees has deteriorated. Between 1982 and 1984, for example, the physicians' services component of the Consumer Price Index increased 13.2 percent, while the median Medicaid fee for a brief office examination remained virtually unchanged (278).<sup>18</sup>

What do these restrictive payment levels mean for Medicaid recipients' access to medical care? Theoretically, the Medicaid fee level should influence physicians' willingness to treat Medicaid patients; the lower the fee, the less willing physicians would be to serve Medicaid patients. An economic model of physicians' practices predicts that if Medicaid patients cannot obtain all the services they would like to from physicians' practices at existing fee levels, then decreasing the Medicaid fee relative to the private fee will reduce the supply of services to Medicaid enrollees (266). The same model also predicts that, all other things being equal, an increase in private patients' demand for physicians' services or in physicians' practice costs will reduce the amount of care that physicians are willing to provide to Medicaid patients; an increase in the supply of physicians, on the other hand, will increase the amount of care that physicians will provide to Medicaid patients.

Empirical studies of physician participation in Medicaid have supported this theory (266,431, 489). In one study of the relationship between low Medicaid payment rates for visits relative to pri-

<sup>18</sup>Some States experienced actual reductions in Medicaid payment levels, while others had increases. For example, in Arkansas, the fee for a brief office exam increased by 14.2 percent, from \$9.20 to \$12, while in Mississippi, it decreased by 31.7 percent, from \$9 to \$4.20 (673).

vate fees and the number of physician visits by Medicaid children, investigators found that overall use rates were not affected, but the site of care was (384). With more stringent Medicaid fees, Medicaid children received more of their care in hospital outpatient departments and clinics and less in physicians' offices.

Are the current Medicaid fees paid to physicians so low as to seriously jeopardize the availability of physicians willing to serve Medicaid children? We can say very little about the question of physician participation in Medicaid and its relationship to access. If acceptable access means the ability of a Medicaid patient to find a qualified doctor within reasonable time and distance (not necessarily a doctor of the patient's own choosing), then participation in Medicaid by all physicians is not necessary. Yet it is difficult to measure the extent to which Medicaid children are able to find qualified participating doctors willing to serve them.

Available evidence on physician participation in Medicaid, summarized in appendix E, has serious limitations. As discussed in appendix E, it is difficult to measure the extent of physician participation in Medicaid. Most of what is known is based on national surveys of physicians (5,430, 431,489,593)—and these data probably overestimate the rate of physician participation.

Despite their limitations, however, data from surveys of physicians do permit reasonably valid observations about trends in participation over time and across specialties and geographic region. It appears from these data that there is wide variation in pediatrician participation across States and geographic regions.

It also appears that pediatricians' participation in Medicaid has not deteriorated in the recent past despite the relative decline in Medicaid fees paid to physicians and increases in practice costs. In fact, from 1978 to 1984, pediatrician participation in Medicaid actually increased slightly. Whether trends in participation have been continuing in the same direction in the past few years, however, is not known. The question of how the opposing forces of increased physician supply and increased practice costs are playing out in terms of physicians' willingness to serve Medicaid patients today cannot be answered at present. Be-

cause of the high interstate and interregional variation in physician participation in Medicaid, however, it is very likely that some populations of Medicaid children cannot receive care from private pediatric services, while others are able to obtain qualified services.

### **Hospital Inpatient Payment Controls**

As of June 1985, 37 States had abandoned retrospective cost-based reimbursement for inpatient services (366) and replaced it with some type of prospective hospital payment system, whereby rates of payment are specified in advance and hospitals receive the specified amount regardless of what is done for the patient. Thirteen of the thirty-seven States had adopted prospective per-case payment, paying a fixed amount for each Medicaid admission. Twenty-one States had adopted prospective per-diem payment, paying a fixed amount for each day a patient is hospitalized. The three other States used some sort of prospective budget review or negotiation approach to setting rates.

There is little evidence on how these alternative payment methods affect the use of hospital care by children. One study of AFDC children's hospital use in 1980 found that the operation of a hospital payment scheme different from the Medicare cost-reimbursement principles had no statistically significant impact on these children's hospital use (413).

The impact of hospital inpatient payment controls on access to care for Medicaid beneficiaries depends not only on the method of payment, but also, and perhaps largely, on the payment level. If payment levels are so low that they do not cover the costs of treating Medicaid patients, then hospitals have incentives not to offer services for these patients. On the other hand, even under a per-case payment system, if the Medicaid payment level is high enough on the average to result in an operating surplus, then hospitals would be inclined to serve Medicaid patients. Some observers have argued that the use of prospective per-case payment by Medicaid agencies has created serious problems for hospitals with neonatal inten-

sive care units because the methods used to adjust for the seriousness of these cases are insufficiently sensitive.<sup>19</sup>

### Administrative Procedures

The fourth major area in which Medicaid falls short of its promise is in the use of administrative procedures that delay or deter the receipt of health services by eligible children.

In a 13-State survey of pediatricians conducted in 1983, 46 percent of respondents considered the complexity of Medicaid program regulations to be “very important” problems of Medicaid; 52 percent considered the unpredictability of Medicaid payments to be very important (18). To the

extent that children’s access is affected by participation rates, these problems have serious implications for access.

Receipt of early or timely care depends on families’ being informed of and understanding the meaning of their eligibility for Medicaid. The consequences of expanding eligibility for young children under OBRA-87 may depend in a fundamental way on these families’ being informed of their eligibility and encouraged to make use of it. There are anecdotal examples of States failing to make minimal efforts to inform providers or patients of their likely eligibility for Medicaid. For example, although the State of Georgia has three Medicaid waivers to provide for eligibility for technology-dependent children living at home, neither families nor hospital discharge planners have been informed of the waivers. Indeed, even among the Medicaid agency staff, there is much confusion and misinformation about whether additional children may be covered (664).

<sup>19</sup>See OTA’s 1987 case study on neonatal intensive care for low birthweight infants (665) for a discussion of this issue.

## ALTERNATIVES TO PRIVATE AND PUBLIC HEALTH INSURANCE FOR CHILDREN

A number of Federal programs directly fund or provide health care for children. Among them are the following programs which are discussed briefly below:

- the Maternal and Child Health services (MCH) block grant,
- the Preventive Health and Health Services (PHHS) block grant,
- Head Start,
- community health centers (CHCs),
- migrant health centers (MHCs), and
- the Indian Health Service (IHS).

### Maternal and Child Health Services Block Grant

Authorized under Title V of the Social Security Act, the MCH block grant provides health services to mothers and children. The block grant was created as part of OBRA-81 (Public Law 97-35) and consolidated Federal funding for several categorical programs: maternal and child health

services, crippled children’s services, Supplemental Security Income (SSI) services for disabled children, prevention of lead-based paint poisoning, testing for genetic diseases, prevention of sudden infant death syndrome, hemophilia treatment centers, and prevention of adolescent pregnancy.

The Federal agency that administers MCH block grants is the Health Resources and Services Administration of the Public Health Service. It is up to each State, however, to decide what services MCH block grant funds are used for. Instead of operating as an insurance program, Federal block grants are awarded to the States, which in turn provide grants directly to public and private providers of maternal and child health care or crippled children’s services (209,541).

Federal and State funds for maternal and child health services have decreased markedly throughout the 1980s (see ch. 2). Expenditures for specific services (e. g., prenatal care, well-child care) under the Title V MCH block grant program are

nearly impossible to identify, largely because the Federal Government does not require the collection or reporting of data on such expenditures. This problem is exacerbated by the fact that there are no requirements regarding minimum services and eligibility. As a consequence, very little is known about who receives what types of services under the MCH block grant (209).

### **Preventive Health and Health Services Block Grant**

Like the MCH block grant, the PHHS block grant was created as part of OBRA-81. The PHHS block grant consolidated funding for eight categorical grants: health education and risk reduction, comprehensive public health services, emergency medical services, home health services, rodent control, community- and school-based fluoridation, detection and prevention of hypertension, and rape crisis and prevention services.

The emphasis of the PHHS block grant is different from that of the MCH block grant. No PHHS funds go toward handicapped children's services, very little PHHS money is spent on maternal and child health, and a much greater percentage of PHHS money is spent on nonpersonal health services. Of \$68.2 million for PHHS spent by 46 State health agencies in 1984, \$41.7 million (61 percent) was for personal health services, \$7.3 million (10.7 percent) was for environmental health, and \$11.8 million (17 percent) was for health resources (511). The Federal agency that administers the PHHS block grant is the Centers for Disease Control, but each State retains its own decisionmaking authority over how the funds are distributed for the various services (511).

### **Head Start**

Project Head Start, begun in 1965, provides educational, social, nutritional, and medical services to low-income preschool children. The program is overseen by the Administration for Children, Youth, and Families within the Office of Human Development Services of the U.S. Department of Health and Human Services, but it is administered at the local level by Head Start agencies. A total of 1,305 Head Start programs in the United States serve *452,000* children (676). The

Federal budget for Head Start was over \$1 billion in 1986 (676).

Medical services provided in the Head Start program include a complete examination (including vision and hearing tests), identification of handicapping conditions, immunizations, a dental exam, mental health services, and nutritional services. Followup treatment is provided for any health problems that are identified. Fifty percent of the children in Head Start are enrolled in EPSDT and get their medical care paid for through that program (676).

### **Community Health Centers**

CHCs are part of the primary care program administered by the Bureau of Health Care Delivery and Assistance within the Health Resources and Services Administration of the U.S. Department of Health and Human Services. The goal of CHCs is to provide primary health care to medically underserved areas. As of 1984, there were 600 CHCs with 700 satellite clinics, serving over 6 million people (60 percent of whom were below the Federal poverty level, and 25 percent with incomes between 100 and 200 percent of the Federal poverty level). One observer reports that nearly half of all CHC users are completely uninsured (543).

A wide range of services is available through CHCs (224). Certain services, called "primary health services," are provided by all CHCs. These include, for example, preventive health services (e.g., prenatal care, family planning), diagnostic care, emergency care, and transportation. Other services, called "supplemental health services," are provided at the grantee's option. Such services include hospital care, health education, and dental and vision care, among others.

Services are provided on a sliding fee pay scale based on income and family size, with families living below the Federal poverty level eligible for free care, and CHCs are required to seek third-party reimbursement (Medicaid, Medicare, private insurance) if available. The CHC program is a grant program, authorized under Section 330 of the Public Health Service Act, with a 1987 Federal budget of \$400 million (696). Federal funding in real dollars for CHCs has declined markedly

since 1981 (see ch. 2). CHCs also receive some funding from nonprofit groups (224).

### Migrant Health Centers

Like CHCs, MHCs are part of the primary care program administered by the Bureau of Health Care Delivery and Assistance. MHCs provide primary health care to migrant and seasonal farm workers and their families. There are 122 MHCs operating approximately 378 clinics that serve over 450,000 people. In 1987, the Federal appropriation for the MHC program was \$45.4 million. Nearly two-thirds of the MHCs also receive funds from the CHC program (695).

### Indian Health Service

IHS, a part of the Public Health Service, provides health care services to American Indian and Alaska Native children at no cost to the individ-

ual patient or patient's family. The services provided by IHS include inpatient and ambulatory medical services, dental care, mental health and alcoholism services, preventive health (immunizations and environmental services such as sanitation and water safety), health education, and Indian health manpower development programs (662). IHS provides these services through its network of IHS-owned hospitals, health centers, and clinics, or indirectly, by purchasing services that are not available from IHS facilities through contracts with private providers (662).

In fiscal year 1987, the Federal IHS was appropriated \$858 million, including \$737 million for clinical services and \$64 million for preventive health (449). According to the 1980 U.S. census, children represent 32 percent of the Indian population. That means that about 300,000 Indian children (of the 960,000 eligible Indians in 1985) receive health care from IHS (662).

## CONCLUSIONS

This chapter has examined the evidence on the relationship between family income and health insurance status and the availability and use of health care services by American children. Low income and lack of adequate health insurance go together, so that children of poor and near-poor families use fewer health care services than do children of middle-class families. Nationally, between 14 and 19 percent of American children have no health insurance whatsoever. About 42 percent of all uninsured children have family incomes below the poverty line. Low-income children without insurance coverage use substantially fewer health care services than do either privately insured children or Medicaid children, although Medicaid does not appear to eliminate all differences in the use of services between poor and non-poor children. The sicker the child, the stronger the effect of income on the frequency of use of health services.

The use of medical care by children is exquisitely sensitive to the cost of obtaining that care, particularly in relation to the parents' ability to pay. Children of poor families that have to pay

for care see physicians less often than those who have free care, and it appears that parents are not generally able to discriminate between visits that are highly effective in treating the child's health problem and those that are not: both kinds of visits decline equally. The same phenomenon exists for children of nonpoor families, but the size of the decline is much smaller.

The Medicaid program offers some relief from the double burdens of poverty and illness for the very poorest segment of children. But it is clear that this care is delivered in settings that differ markedly from those available to middle-class Americans. Medicaid children receive care from hospitals and clinics, while nonpoor children receive care from private physician practices. Whether the quality of such care is higher in one setting than another is unknown, but it can be said that Medicaid children are either not encouraged or not enabled to seek out care as often as nonpoor children.

If the goal of the Medicaid program was to give poor children access to the same kind of medical care available to nonpoor children, it has certainly

not been met. Impediments to serving Medicaid children exist in the form of limitations on covered services, administrative barriers, and, especially, stringent physician payment policies. Although the available evidence suggests that access to pediatricians has not declined substantially in the past 5 years in the United States as a whole, that access has not been high during the entire period, and continued stringency in payment rates can only put more pressure on access in the future.

Other federally supported programs that provide direct care to poor children, particularly to

the uninsured, have been subject to funding cutbacks throughout the 1980s when spending is adjusted for inflation. For example, between 1978 and 1986, Federal appropriations for maternal and child health services declined (in 1978 dollars) by 43 percent; for CHCs by 11 percent; and for MHCs by 33 percent. When the increase in the population without health insurance is considered, the implications for children's access to care are not encouraging.



Part II

# **Prevention of Childhood Illness: Selected Topics**

---

Chapter 4  
**Prenatal Care**

# CONTENTS

	<i>Page</i>
Introduction .....	73
Recommended Components of Prenatal Care .....	73
Use of Prenatal Care.... ..	75
Effectiveness of Prenatal Care .....	75
Problems in Interpreting the Evidence .....	76
Studies of the Effectiveness of Prenatal Care .....	77
Conclusions About the Effectiveness of Prenatal Care .....	80
Cost-Effectiveness of Expanding Medicaid to All Pregnant Women in Poverty . . .	80
Impact of Expanded Medicaid Coverage on the Use of Prenatal Care .....	82
Incremental Costs of Early prenatal Care. ....	83
Savings From the Prevention of Low Birthweight Births .....	83
Required Level of Effectiveness of Prenatal Care .....	85
Access to Prenatal Care: The Role of Third-Party Payment and Alternative	
Funding Sources .....	86
Medicaid .....	87
Private Insurance .....	88
Alternatives to Public and Private Insurance .....	89
Conclusions .....	90

## Figure

<i>Figure No.</i>	<i>Page</i>
4-1. Assumptions in OTA's Base Case Analysis About Changes in the Use of First-Trimester Prenatal Care .....	82

## Tables

<i>Table No.</i>	<i>Page</i>
4-1. Summary of 17 Selected Studies of the Effects of Programs Offering Augmented Prenatal Care .....	79
4-2. Net Incremental Health Care Costs of a Low Birthweight Birth .....	85

# Prenatal Care

## INTRODUCTION

Prenatal care is a type of health care aimed at improving and maintaining maternal and child health. Such care is provided at the earliest possible point—during pregnancy—and thus has the potential for significantly shaping the health of a human being from the very beginning.

---

<sup>1</sup>Prenatal care consists of health services delivered from conception to labor. Related services include *intrapartum care* (received during labor and delivery) and *postpartum care* (rendered immediately following delivery to the sixth week after birth). Prenatal care and intrapartum care combined are referred to as *maternity care*. Definitions of the period for *perinatal care* vary, but in general, this period overlaps the pre- and post-delivery date by several weeks.

The chapter summarizes a wide variety of information on prenatal care. First, it reviews the recommendations of the United States' and other countries' professional groups regarding the content of prenatal care. Then, it reports information on the timing and frequency of visits among subgroups of the U.S. population. Previous studies examining the effectiveness and cost-effectiveness of prenatal care are critiqued and findings summarized. This chapter also presents the findings of OTA's cost-effectiveness analysis of expanding Medicaid to all pregnant women in poverty. The concluding sections of the chapter analyze the role of third-party payment in facilitating access to prenatal care and discuss the implications of OTA's analysis for public policy.

## RECOMMENDED COMPONENTS OF PRENATAL CARE

Prenatal care encompasses a wide range of preventive, diagnostic, and therapeutic services delivered throughout the course of pregnancy with the goal of both a healthy baby and a healthy

mother. The actual care that pregnant women receive varies widely, depending on the number of visits the woman has, as well as on the specific interventions that are applied. Preventive interventions include screening for potentially harmful conditions in the mother and fetus, education and counseling, and sometimes nutritional supplements. Diagnostic and therapeutic interventions represent responses to and followup of problems identified either through symptoms or screening.

Various professional groups in the United States and other countries have provided guidelines for the content of prenatal care, particularly for the preventive elements of such care.<sup>2</sup> Available guidelines cover the prenatal visit schedule, specific assessment and screening procedures, edu-



Photo credit. March of Dimes Birth Defects Foundation

Although early and comprehensive prenatal care is clearly effective, the specific components that make a difference are not fully understood.

---

<sup>2</sup>For a discussion of recommendations by professional groups and experts in the United States, Canada, and Great Britain, see the background paper prepared for OTA by Lorraine Klerman and Helen Burst, entitled "Evidence of the Effectiveness of Recommended Antepartum Care Components" (341).

cation and counseling activities, and nutritional supplementation. The guidelines issued jointly by the American College of Obstetricians and Gynecologists (ACOG) and the American Academy of Pediatrics (AAP) (22,25) call for prenatal care visits to begin as early in the first trimester of pregnancy as possible and to continue every 4 weeks until the 28th week, every 2 to 3 weeks thereafter until the 36th week, and weekly thereafter. This schedule translates into 13 to 15 prenatal visits over the course of a normal pregnancy of between 37 and 40 weeks gestation.

The visit schedule recommended by the Canadian Task Force on the Periodic Health Examination is the same schedule as that of the Americans (89,90). The Royal College of Obstetricians and Gynecologists (RCOG) in Great Britain, on the other hand, recommends substantially fewer visits for women with normal pregnancies. The RCOG schedule calls for a total of seven to nine prenatal visits at various points in pregnancy and beginning at 12 weeks gestation (552). This schedule is based on the concept of "shared antenatal care," in which responsibility for providing services is shared among obstetricians, general practitioners, and midwives. Only three of the nine recommended visits in the RCOG schedule involve an obstetrician. The rest are handled by a combination of the general practitioner and midwives.

For some specific services, there is widespread agreement among the American, Canadian, and British professional societies. The need for determining blood group and screening for antibodies in Rh-negative women, for example, is something that all groups recognize. Screening for syphilis and gonorrhea at the initial visit is another thing they all recommend (341). For other tests, however, there is substantial disagreement about policy among the countries' professional societies. Thus, for example, the use of ultrasound is not recommended as a routine screening examination in pregnancy by the American or Canadian groups, but is recommended by the British at 16 to 18 weeks gestation. The Canadian Task Force on the Periodic Health Examination is the only group that currently recommends routine testing of all pregnant women for chlamydial infections.

The differences among the various professional groups' recommendations reflect in part a lack of definitive evidence regarding the incremental contributions of additional prenatal interventions or visits at particular points in pregnancy. They also reflect the philosophies of the different health systems in which the professional groups practice. In addition, as advances in medical technologies alter both the effectiveness and cost of services, professional standard-setting groups may react at different speeds to new evidence. One new technique for which evidence is only now accumulating, for example, is called "ambulatory tocodynamometry." This technique allows noninvasive ambulatory monitoring of uterine contractions in women at risk for premature labor and may enhance the effectiveness of the available therapies to reduce the incidence of premature birth (see app. F). So far, no professional society has issued guidelines regarding its use.

Professionals disagree not only about the amount and content of prenatal care visits for normal pregnancies, but also about which pregnancies are high-risk and how these should be handled. Women with medical histories or conditions that suggest elevated risk obviously justify closer monitoring during pregnancy than other women do, but there are no widely agreed upon guidelines for the appropriate scope of services under each circumstance. Neither are there generally accepted standards for women who are at elevated risk of poor outcomes because of social or demographic risk factors (e. g., adolescents or poor women).

The lack of generally accepted standards for the content of prenatal care for high-risk women reflects the conflicting evidence about the importance of specific interventions. Later in this chapter, OTA reviews the evidence on the effectiveness of prenatal care in improving birth outcomes, but it is important to note that that evidence is limited to assessments of the effect of earlier and more frequent prenatal visits on birth outcomes or of the effect of programs that offer packages of augmented prenatal care services to women in demographically defined high-risk groups. The precise content of the care that is offered is often undocumented.

## USE OF PRENATAL CARE

How closely do American women adhere to U.S. professional groups' recommendations for the timing and frequency of prenatal care? In 1984, 20 percent of white babies and 39 percent of black babies in the United States were born to mothers who had not had their first visit for prenatal care by the end of the first trimester of pregnancy (712). The mothers of 5 percent of white and 10 percent of black babies born in 1984 had not had a prenatal care visit before the 7th month of pregnancy (712). From 1981 to 1984, the percentage of women obtaining late or no prenatal care in this country increased: for blacks, the percentage increased from 9.1 percent in 1981 to 10 percent in 1984; for whites, the percentage increased more modestly—from 4.3 percent in 1981 to 4.6 percent in 1984.

Most mothers of both races in the United States fail to receive the 13 to 15 prenatal visits recommended by American professional groups. Among mothers with full-term pregnancies, only 33 percent of whites and 23 percent of blacks had 13 or more prenatal visits in 1984 (712).

The timing of the first prenatal visit varies widely among different U.S. population subgroups. Ingram and colleagues compared 10 groups of women defined by race, marital status, maternal age, and educational attainment in 5 years between 1970 and 1983 (295). Unmarried teenagers with less than a high school education were the least likely to obtain early prenatal care, while older married mothers with more than a high school education were the most likely to ob-

tain it. These findings held for both whites and blacks. Thus, for example, in 1983, about 45 percent of unmarried teenagers who did not graduate from high school initiated prenatal care in the first trimester of pregnancy; the comparable figure for older married mothers with more than a high school education was 80 percent.

As expected, poverty status is also related to American women's use of prenatal care services. In 1980, two-thirds of women with family incomes below 150 percent of the U.S. poverty level initiated care in the first trimester, as compared to over 80 percent of those with higher family incomes (598). Similarly, women with low incomes were three to four times more likely to receive late or no prenatal care than women with incomes above 150 percent of the poverty level.

To summarize, the receipt of early and frequent prenatal care by American women varies widely depending on the demographic and economic group to which a woman belongs. To the extent that early and frequent prenatal care affects the outcome of pregnancy, these variations contribute to the observed intergroup differences in rates of low birthweight and infant mortality. Although it appears that the majority of American women actually make fewer visits for prenatal care than is recommended by American physician groups, the differentials by income, age, race, and education suggest that targeting effective prenatal care services to the women in high-risk groups holds promise for improving pregnancy outcomes.

## EFFECTIVENESS OF PRENATAL CARE

This section summarizes the evidence on the effectiveness of prenatal care in altering two critical aspects of infant health: low birthweight and neonatal mortality. Low birthweight (under 2,500 grams) is a good predictor of infant mortality (see ch. 2) and is also associated with high rates of chronic and disabling illness and costly medical care. Neonatal mortality, independent of birthweight, is also a good indicator of the overall

health of newborns and maybe directly affected by the nature of prenatal care that women receives

Because prenatal care includes not only preventive interventions such as screening and counsel-

<sup>3</sup>Low birthweight and neonatal mortality are both strongly correlated with another outcome measure—premature birth (defined as birth at 37 weeks gestation or earlier). This measure of outcome is problematic, however, because current methods of dating gestational age are imprecise and are also improving over time.

ing but also treatment when needed, it is bound to be effective in altering the health of some mothers or infants. Treatment of gestational diabetes or hemolytic disorders, for example, is critical to healthy outcomes for both mother and infant. Yet, if frequent routine screening for a particular condition does not offer any advantage in terms of allowing more effective treatment or better management of labor and delivery than would seeking care when symptoms develop, the value of such screening is dubious. Thus, the real question of effectiveness is not whether prenatal care makes any difference to child health, but exactly which preventive measures—monitoring, screening, education and counseling, or nutritional supplements—are effective and at what intervals in the course of a normal pregnancy they are most effectively applied.

This question can be addressed at various levels of detail, ranging from examination of every possible preventive component of each prenatal care visit to a general assessment of the effects of more care v. less care, as measured by the number of prenatal visits, early initiation of care, or receipt of enriched services through special programs. Although an overall assessment of the effectiveness of prenatal care would ideally build on evidence regarding individual components, it is beyond the scope of this assessment to examine the effectiveness of individual components.<sup>4</sup> Instead, the large body of evidence accumulated on the impact of early, more frequent, or enriched prenatal services on low birthweight and neonatal mortality will be the basis for this analysis,

### Problems in Interpreting the Evidence

An ideal study of any prenatal care regimen would be prospective, with randomized assignment of patients to experimental and control

<sup>4</sup>The Public Health Service has established an expert panel on the content of prenatal care, with the objective of examining the usefulness of specific components of prenatal care. The work of the panel is currently in progress. For other information on the effectiveness of individual components of prenatal care, see the background paper prepared for OTA by Lorraine Klerman and Helen Burst reviewing the evidence on effectiveness of chlamydia testing, routine ultrasound screening, smoking cessation programs, and nutritional supplementation (552). The effectiveness of ambulatory tocodynamometry, a new technique for detecting premature labor in high-risk women, is discussed in app. F in this report.

groups. This ideal is rarely achieved in practice, however, because it would be unethical to withhold early or frequent prenatal care from women seeking it. Even in programs offering enriched services, randomized assignment is rarely achieved. In only one published study—a comparison of a program of home visits with standard prenatal care (469)—were subjects randomly assigned to experimental and control groups. All other studies of the impact of prenatal care on infants' health depart to one degree or another from the experimental ideal.

Not surprisingly, then, the validity of all studies of the impact of prenatal care on infants' health is questionable to some degree. The critical threat to validity is the problem of self-selection bias—i.e., the likelihood that women who seek more care, earlier care, or enriched services are inherently different in terms of their health risks from women who do not.

Two kinds of self-selection bias exist in studies of prenatal care. The most familiar form of self-selection bias follows the logic that women who seek prenatal care early and often routinely behave in healthy ways, of which early receipt of prenatal care is but one reflection. Women who receive earlier and more prenatal care, for example, may also be less likely to smoke cigarettes or abuse alcohol (218). These women are probably healthy on the whole and thus are likely to be at lower than average risk of poor outcomes. A study in which this kind of “favorable selection” operates would tend to *overestimate* the effectiveness of prenatal care.

The second form of self-selection operates to bias the results of a study in the opposite direction. In this case, women who experience a problem with their pregnancy or have information that leads them to expect problems (e.g., a poor pregnancy history) would tend to seek care early and often. These women are likely to be at higher than average risk of poor outcomes. A study in which this kind of “adverse selection” occurs would tend to *underestimate* the effectiveness of prenatal care.

As a consequence of self-selection bias, simple comparisons between users and nonusers of prenatal care, or between more frequent and less frequent use, are unacceptable. Researchers have

used various methods to control for self-selection bias. Some use multivariate techniques in which variables thought to be associated with favorable selection (e. g., income, education, smoking behavior) and adverse selection (e.g., preexisting health problems, complications of pregnancy, prior fetal or infant death) are entered into the analysis as control variables along with measures of prenatal care use. In studies of programs of enriched care, pregnancy outcomes of women who are eligible for a program are often compared with those of a group of similar but ineligible women. If carefully selected, the comparison group can provide reasonable validity. Nevertheless, the question always remains whether the self-selection bias has been adequately controlled in all such studies, and lacking a gold standard by which such adjustments can be judged, one can never be completely confident that a study's results are valid.

Thus, although there is a substantial body of literature on the effectiveness of prenatal care, the interpretation of this literature ultimately requires judgments about its validity. Individuals who would apply the strictest standards of validity probably would not accept any of the evidence—whether pro or con—as sufficient. Yet policy decisions regarding prenatal care need to be made even in the face of imperfect information. Therefore, OTA has taken a somewhat more relaxed position with regard to validity. The findings of more than 55 studies of the effectiveness of prenatal care need not be ignored because they only imperfectly control for self-selection biases. Rather, each study can be assessed both for the degree to which it has successfully controlled for these biases and for the strength of its findings. The results of such an assessment are summarized below.

### Studies of the Effectiveness of Prenatal Care

Studies of prenatal care fall into two general categories:

1. those based on birth and death records (i.e., vital records); and
2. those evaluating programs offering enriched or augmented services.

Studies in the first category have the advantage of large sample sizes, but these databases offer limited information on prenatal care use and mothers' characteristics; typically, information on prenatal care use is limited to number of visits or trimester in which care began. Studies in the second category often use well-selected comparison groups and sometimes have access to more extensive information on patterns of prenatal care use; however, these evaluations typically compare care that is generally available to women in the community with more comprehensive programs, and it is difficult to generalize from these studies about the value of more v. less prenatal care of the kind generally available.

### Studies Based on Vital Records

Numerous studies of births and deaths in hospitals, cities, counties, States, and the Nation as a whole have found a positive relationship between the use of prenatal care and birth outcomes. Of 21 multivariate studies of the effect of prenatal care on birthweight that controlled in some way for maternal demographic or medical risks, for example, 18 found evidence of a statistically significant positive effect in at least some groups of women. (See table G-1 in app. G for detailed descriptions of these studies.) Similarly, of 15 controlled studies of the effects of prenatal care on neonatal mortality, 11 found a statistically significant negative relationship between neonatal mortality and the use of prenatal care. (See table G-1 in app. G.)

Among studies finding that prenatal care had a positive effect on birth outcomes, the size of the effect varied widely because of differences in measures of prenatal care and control variables selected for the analysis. A 1981 study of births in Baltimore, Maryland, that controlled for several demographic and medical risk factors found, for example, that women who received adequate prenatal care<sup>5</sup> were about 1½ times more likely to deliver normal weight babies than those who did not (573). Another study of births in 1977 that controlled only for mother's race and education found that mothers receiving no prenatal care

<sup>5</sup>Adequate care was defined by an index of adequacy of care first developed by Kessner (328) and modified by others.



were 2½ times as likely to deliver a low birth-weight baby (227a).

Five recent analyses of prenatal care using data from vital records have applied an analytic technique known as instrumental variables to control for adverse selection bias. These studies uniformly find even stronger positive effects of prenatal care on neonatal mortality and birth-weight than are found with traditional multivariate techniques. (See table G-2 in app. G for a summary of studies using instrumental variables.) Because these studies generally do not adequately control for favorable selection bias, however, they can be expected to overestimate the effects of prenatal care on birth outcomes.

### **Studies of the Effectiveness of Programs Offering Augmented Prenatal Care**

For the past 20 years, a number of Federal and State-initiated programs have offered prenatal care services that differ in scope and mix of services from those routinely available in the community. These programs typically offer a variety of supplementary services to target groups of high risk women, usually teenagers or poor women. For example, Maternity and Infant Care projects, the Improved Child Health Project, and Improved Pregnancy Outcome projects were established by the Children's Bureau and through Title V of the Social Security Act of 1935 to improve the delivery of care to the generally high-risk and underserved populations of poor women and adolescents (128,212,395). State initiatives with similar goals, such as the Obstetrical Access Project in California (615) and other local and hospital-specific programs were also established. These programs were developed to address unequal access to prenatal services or a perceived need for more comprehensive care for high-risk women. In addition to providing routine medical services during pregnancy, these initiatives include a wide variety of supplementary services such as out-

reach,<sup>7</sup> formal education and counseling, coordination of auxiliary support services, transportation to and from medical visits, and/or home visitation.

OTA found 25 studies of the effectiveness of programs offering augmented prenatal care services. (See table G-3 in app. G.) The target groups for the majority of these programs are teenagers or poor women. Most studies compare the outcomes of births to women enrolled in a particular enriched care program with the outcomes observed in a selected comparison group of women receiving care elsewhere. Thus, these studies examine the incremental benefit of augmented care over and above services received by the comparison group.

The studies of the effectiveness of augmented prenatal care programs have found that publicly funded comprehensive prenatal care programs, such as Maternity and Infant Care projects, the Improved Child Health Project, and Improved Pregnancy Outcomes projects, increase the use of prenatal care among certain groups of poor women and adolescents. More pregnant women get care early and often through these programs. Studies of augmented prenatal care programs, however, show a less consistent effect on birth outcomes than was found in studies based on vital records data. Some significant findings were observed for specific subgroups of the target populations, such as adolescents and women at high risk for poor pregnancy outcomes. For example, four of six studies of augmented services for pregnant adolescents found that such care reduced the frequency of low birthweight and premature births. For teenagers and women at high risk, Maternity and Infant Care projects, the Improved Child Health Project, and Improved Pregnancy Outcomes projects may provide an appropriate mix of routine and specialized care. Poor women at average or low risk, however, may not receive much incremental benefit from these comprehensive programs over and above the benefit of the care they would routinely receive.

<sup>6</sup>In general, the instrumental variables technique attempts to correct for adverse selection bias by replacing the observed value of prenatal care with a predicted value derived from a regression of prenatal care on explanatory variables that are uncorrelated with the health status of the mother. Thus, the predicted prenatal care variable is also assumed to be uncorrelated with health status. This predicted prenatal care variable is then used in a second-stage regression to predict its effect on the outcome of pregnancy.

<sup>7</sup>Outreach generally means two types of services that have different goals: to increase access and/or to improve medical care compliance. For example, in some programs, outreach refers to efforts to enroll pregnant women early in gestation. In other programs, outreach focuses on getting enrolled patients to keep their appointments and to follow medical regimens or advice.

The relationship between early or more frequent prenatal care and birth outcomes appears to be much more tenuous in this group of studies than it was in the studies based on vital records. Some of the studies of augmented care found improvements in the initiation of care among program participants but no effects of the program on birth outcomes. OTA analyzed 17 studies of programs for poor women or teenagers for which information on either outreach services or time of initiation of care was available for both an experimental and comparison group (see table 4-1). Overall, only about one-half of these 17 studies found that augmented prenatal care services had significant impacts on birthweight or neonatal mortality. In 7 of the 17 programs, the experimental group receiving augmented services initiated prenatal care earlier than the comparison group; in 4 of the 7, augmented prenatal care was found to have significant positive effects on birth outcomes. Of the 17 programs offering augmented prenatal care services, 11 appeared to have an outreach component designed to enroll women into care early in their pregnancies. Information on when care began was available for 9 of the 11

programs. Six of the nine were successful in bringing more women into care early, but only three of the six with successful outreach and other supplementary services showed an impact on birth outcomes.

One reason for the lack of consistent results among the studies may be that the studies represent a diverse mix of prenatal interventions with different levels of effectiveness. Even under the rubric of Maternity and Infant Care projects, for example, services delivered in one geographic area may be quite different from those provided in another.

In many studies, no information was provided regarding the scope of services received by comparison groups. Investigators assumed that women in the comparison group received less care than women in the augmented programs. In fact, because the comparison groups also tend to comprise poor women, some of them may have been enrolled in comparable programs of specialized care. Thus, in some studies the differences between the augmented care and comparison services may not have been great.

**Table 4-1.—Summary of 17 Selected Studies of the Effects of Programs Offering Augmented Prenatal Care<sup>a,b</sup>**

Program characteristics	Impact on initiation of care			Total number of studies
	No differences between experimental and comparison group	Difference favors experimental group	No information	
<b>Outreach and extra services:</b>				
Number of studies . . . . .	1	4	0	5
Number with significant effect on birth outcomes <sup>c</sup> . . . . .	0	1	0	1
<b>Extra services (may include outreach):</b>				
Number of studies . . . . .	2	2	2	6
Number with significant effect on birth outcomes <sup>c</sup> . . . . .	2	2	0	4
<b>Extra services only:</b>				
Number of studies . . . . .	1	1	4	6
Number with significant effect on birth outcomes <sup>c</sup> . . . . .	1	1	2	4
Total number of studies . . . . .	4	7	6	17
Total number of studies with significant effects on birth outcomes <sup>c</sup> . . . . .	3	4	2	9

<sup>a</sup>Programs offering augmented prenatal care are programs that provide supplemental services in addition to prenatal medical care. These programs provide one or more of the following types of special services: outreach, transportation, nurse home visitation, nutrition and social services, health education, followup of missed appointments, case management/coordination of services, and dental care.

<sup>b</sup>This table displays results from 17 of the 25 studies of augmented prenatal care programs that appear in table G-3 in appendix G of this report. Eight of the twenty-five in table G-3 were excluded from this table for the following reasons: 1) the study did not include a comparison group that received an alternative form of care, 2) the study examined employee-based health maintenance organization programs of care, or 3) the study did not report information on outreach and initiation of care.

<sup>c</sup>Birth outcomes include low birthweight and neonatal mortality.

<sup>d</sup>Outreach in this context means efforts to bring patients into care early in pregnancy.

SOURCE: Office of Technology Assessment, 1988.

The most important explanation for the mixed results is the limited power of the experiments. The power of a statistical test—i.e., the probability that a specified difference between the experimental and comparison groups will be detected in the experiment—depends on the significance level selected, the size of the effect that one wishes to detect, and the sample size (113). Very large sample sizes are needed for adequate power to detect a small but potentially important difference between program participants and nonparticipants. Most studies do not have a large enough sample size to detect a difference in birthweight of the magnitude required for the costs of prenatal care to be outweighed by savings in the costs of treating low birthweight babies.<sup>a</sup>

Six studies referred to in table 4-1 examined augmented programs that included extra services but no outreach aimed at getting women into care early. Four of the six showed significant effects on birth outcomes. These findings suggest that provision of extra services to adolescents and high-risk women may be effective in improving birth outcomes. In some cases, the availability of supplementary services appears to compensate for failure to improve patterns of initiation of prenatal care. For example, home visit services may be a key component of augmented care. Although the

<sup>a</sup>To illustrate, OTA conducted a power analysis on data presented in Peoples, et al. (486). That study examined an augmented care program that succeeded in bringing more black women into care early; however, no significant difference in the low birthweight rate was found between the experimental and comparison groups. Applying conventional levels of statistical significance and power (0.05 and 0.80 respectively), OTA found that, given the observed differences in the use of first-trimester care, the Peoples, et al., study would need a minimum of 10,000 participants in each group to detect a difference in low birthweight rates equal to that detected by Joyce (i.e., every 1-percent increase in the number of women receiving first-trimester care decreases the low birthweight rate by 0.045 percentage points)(311). The actual sample sizes in the Peoples, et al., study ranged from 297 to 1,254.

evidence is limited, such services for adolescents and high-risk women appear to improve birth outcomes, especially birthweight (169,433,469,725).

## Conclusions About the Effectiveness of Prenatal Care

The weight of the evidence on the effectiveness of prenatal care, both from studies based on vital records and from studies of programs offering augmented prenatal care services, supports the contention that birth outcomes can be improved with earlier or more comprehensive prenatal care. Indeed, given the design problems inherent in many studies of programs offering augmented services, it is noteworthy that so many of them did detect effects on birthweight or neonatal mortality. The evidence appears to support the value of both early and frequent prenatal care and the provision of enhanced services to adolescents and high-risk women.

Although the evidence clearly supports the effectiveness of prenatal care, it is less revealing about the size of the effect that can be expected from increasing the quantity or quality of prenatal care received by any segment of the population. The studies based on vital records data control for self-selection biases to varying degrees and only very imperfectly at best; one cannot know how strong the two opposing biases (adverse and favorable selection) are or to what extent each has been accounted for in any study. The next section presents OTA's analysis of the effect size required if an expansion of Medicaid prenatal care benefits to all pregnant women in poverty is to pay for itself in net savings in U.S. health care costs. That effect size is then compared to the findings of several reasonably well-designed effectiveness studies to ascertain how reasonable it is to expect such an effect.

## COST-EFFECTIVENESS OF EXPANDING MEDICAID TO ALL PREGNANT WOMEN IN POVERTY

If prenatal care can improve birth outcomes, the logical next question is whether a specific strategy to increase access to effective services is worth its costs. OTA examined the net effect on health

care costs of expanding Medicaid eligibility to all pregnant women in poverty in 1986.<sup>9</sup>The Om-

<sup>9</sup>Other studies of the cost-effectiveness of prenatal care have examined the net costs of strategies involving augmented services or

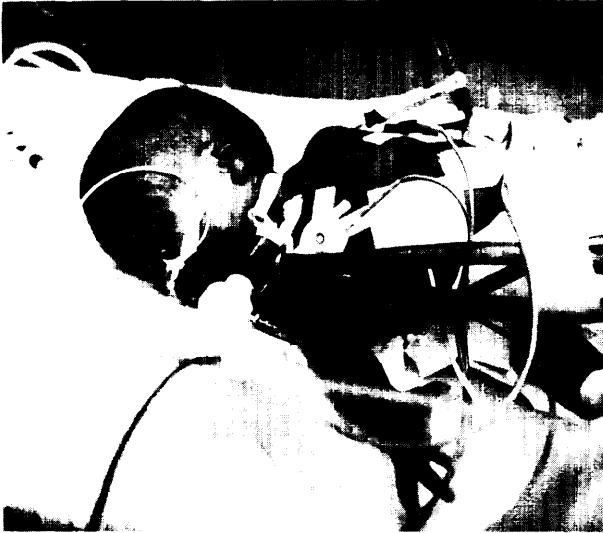

Photo credit March of Dimes Birth Defects Foundation

Some of the costs of treating low birthweight babies with neonatal intensive care can be prevented with early prenatal care.

nibus Budget Reconciliation Act of 1986 (OBRA-86) (Public Law 99-509) gave States the option of expanding eligibility to pregnant women whose family incomes are below the U.S. poverty level but above the State's Aid to Families With Dependent Children (AFDC) standards of need (420). By January 1, 1988, 26 States had elected to exercise that option (271a).

OTA's analysis presented here is concerned with the net costs or savings of expanding eligibility that accrue to the U.S. health care system as a whole, not solely to the Medicaid program. Although Medicaid program administrators must be concerned with budgetary impacts of their policies, the most appropriate stance from a policy perspective is to assess the net costs of a specific strategy to society—not to a particular program. In the case of a program extending Medicaid benefits to all pregnant women in poverty, Medicaid would pay for services that had previously been paid for by patients, private insurers, philanthropic organizations, other government agencies, and providers themselves. These transfers of

expanded benefits to pregnant women. Most such studies look at net costs to a public program (e. g., Medicaid) and are based on estimates of effectiveness taken from a single study. See table C-4 in app. G for a review of cost-effectiveness studies of prenatal care.

responsibility for payment are not trivial,<sup>10</sup> but they cannot be the sole or even principal guide for public policy.

Because low birthweight is such a costly condition to treat, both in the short run (with neonatal intensive care) and in the long run (with services to chronically ill and disabled children), the costs of prenatal care must be considered against the potential savings in these treatment costs from reducing low birthweight. Thus, the potential for saving net health care costs depends in a critical way on the estimates of effectiveness of prenatal care used in the analysis. Although available evidence generally supports the contention that early or more prenatal care does improve birth outcomes, it does not provide unequivocal quantitative estimates of the effect of prenatal care on low birthweight.

OTA's approach in this analysis, therefore, was to calculate the reduction in the rate of low birthweight that would be necessary to balance the extra prenatal care costs with equal savings in the short- and long-run costs of treating low birthweight children. This figure was then compared to the evidence on the effectiveness of prenatal care to determine whether the level of effectiveness required for costs to be outweighed by savings is reasonable to expect from the Medicaid expansion strategy. If expansion of prenatal care to all pregnant women in poverty is not cost-saving to the U.S. health care system, its costs would then need to be weighed against its effectiveness in saving lives and preventing the chronic illness and disability that is associated with low birthweight.

OTA's analysis has three major components:

- the impact of expanded Medicaid coverage on the use of prenatal care by pregnant women in poverty,
- the extra costs of providing the additional prenatal care, and
- the savings associated with prevention of a low birthweight birth,

Each is discussed below.

<sup>10</sup>The Medicaid program costs associated with this policy were estimated by the Congressional Budget Office (649).

### Impact of Expanded Medicaid Coverage on the Use of Prenatal Care

The Congressional Budget Office estimated that 194,000 pregnant women with incomes below the poverty level would become eligible for Medicaid if all States adopted the option under OBRA-86 (649). About 113,000 of these women would carry private insurance, and the other 81,000 would be uninsured .11

There are numerous ways to measure changes in the amount and quality of prenatal care consumed, but OTA's analysis focuses on increases in the frequency of care in the first trimester of pregnancy. Information on the use of prenatal care by poor women was drawn from the 1982 National Survey of Family Growth (708).

Figure 4-1 summarizes the assumptions made in OTA's analysis about expected changes in the frequency of first-trimester care for the target population as a whole .12 The left-hand column shows the approximate distribution of care by trimester in the target population without expanded Medicaid coverage. Among women in the target population, 42 percent do not get first-trimester care. OTA assumed that 44 percent of these women would shift to first-trimester care if they were eligible for Medicaid. 13 Equal percentages of those originally receiving second- and third-trimester care or no care were assumed to shift

Figure 4-1.—Assumptions in OTA's Base Case Analysis About Changes in the Use of First-Trimester Prenatal Care

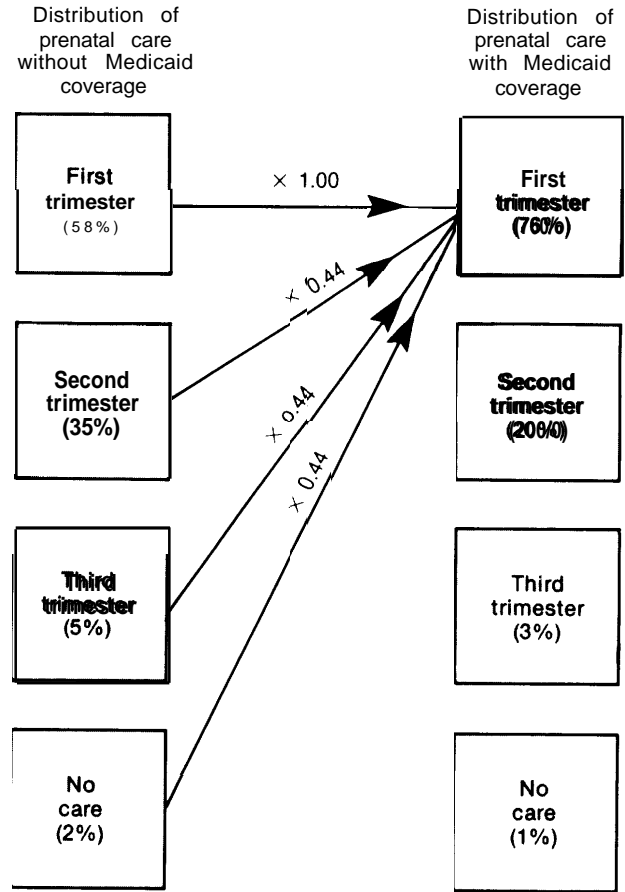

SOURCE: Office of Technology Assessment, 1988

<sup>11</sup>Prior to gaining Medicaid eligibility, pregnant women in the target population would either be covered by private insurance or uninsured. For women with private insurance, Medicaid would pay for maternity services not covered by private plans and all coinsurance and deductible amounts. For the uninsured, Medicaid would cover all maternity care. The Congressional Budget Office assumed that 90 percent of the women without private health insurance and 60 percent of those with private insurance would enroll in Medicaid (649).

<sup>12</sup>The 1982 National Survey of Family Growth divided women into five categories according to source of payment for delivery. Three of these categories were relevant to OTA's analysis: the privately insured, the uninsured, and Medicaid recipients. The OBRA-86 target population comprises privately insured (58 percent) and uninsured women (42 percent). On the basis of National Survey of Family Growth data, OTA computed a weighted average of first-trimester use by privately insured and uninsured women to estimate first-trimester use in the target population as a whole.

<sup>13</sup>According to other data from the 1982 National Survey of Family Growth (708), 44 percent of Medicaid recipients get first-trimester care.

to first-trimester care.<sup>14</sup> Overall, 18.5 percent of the target population ( $0.42 \times 0.44$ ) who would otherwise not obtain first-trimester care would begin care in the first trimester if they became eligible for Medicaid.

OTA assumed that all changes in the pattern of prenatal care use would be shifts to first-trimester care. No adjustments were made for shifting from third-trimester care to second-trimester care, for example. These assumptions

<sup>14</sup>The National Survey of Family Growth data (708) did not separate initiation of care in the third trimester from no care. For cost calculations, OTA made separate estimates of the number of pregnant women in each of these two groups. Based on Texas data for a Medicaid population (399), OTA assumed that 25 percent of those in the third-trimester/no-care group actually received no care.

may have resulted in an overestimation of both the total incremental costs and the effectiveness of prenatal care. (See app. G for further information on expected changes in the use of prenatal care.)

### Incremental Costs of Early Prenatal Care

To estimate the incremental costs of providing early prenatal care to the new users, OTA assumed that prenatal care commencing in the first trimester of pregnancy would include 3 more visits than prenatal care beginning in the second trimester; 6 more visits than prenatal care beginning in the third trimester; and 12 more visits than prenatal care received by women who had previously gone with no prenatal care (312).

OTA estimated the cost of these extra physician visits from a 1986 survey of physician fees (334). The incremental per person cost of first-trimester care over second-trimester care was estimated to be \$90; the incremental per person cost of first-trimester care over third-trimester care to be \$180; and the incremental cost of first-trimester care over no care at all to be \$380.<sup>15</sup>

Using these assumptions, OTA estimated that net national prenatal care costs associated with the additional prenatal care received by the target population in 1986 would be \$4 million.

### Savings From the Prevention of Low Birthweight Births

Preventing low weight births saves costly care in the initial hospitalization of low birthweight babies, in subsequent rehospitalizations for which low birthweight babies are disproportionately at risk, in more frequent and intensive health care due to a high incidence of chronic illness and disability in low birthweight babies, and in long-term

costs associated with institutional or foster care and special education for more seriously disabled children.

The costs of these kinds of health care cannot be estimated with a great deal of precision. Consequently, OTA estimated a range within which such costs are very likely to lie. The net additional costs incurred in the treatment of low birthweight babies over the costs incurred for normal birthweight babies was estimated for three major categories:

1. costs of initial hospitalization (including hospital costs and physician fees);
2. costs of rehospitalizations in the first year of life (hospital costs only); and
3. long-term costs of institutional care, foster care, early intervention, special education and adult services provided from ages 1 to 35 for surviving disabled low birthweight babies.

### Cost of Initial Hospitalization

Data on hospital costs for newborn care by birthweight category are available from the State of Maryland (294).<sup>16</sup> Including both routine newborn care and neonatal intensive care costs, the average cost per hospital stay for a low birthweight infant in 1986 was \$5,894 (in 1986 dollars). For babies weighing more than 2,500 grams, the average cost per discharge was \$658. Thus, the extra cost of hospital care for a low birthweight baby was \$5,236 in 1986.

The results of a recent study have suggested that the costs of neonatal intensive care might be reduced by discharging babies sooner without negative impacts on infant health (72). In that study, the net savings from the program were 25.6 percent of hospital and physician charges. Using these results as a rough guide, the costs of treating low birthweight newborns in the hospital might be reduced by about 25 percent. In that case, the extra costs of initial hospitalization associated with low birthweight might be reduced to \$3,763.

<sup>15</sup>The per visit rates (\$50 for an initial visit and \$30 for each revisit) were based on obstetrician office visit charges, which tend to be higher than similar charges for physicians in other specialty areas who also provide prenatal care (e. g., family practitioners and general practitioners; see ref. 334 J. Thus, the costs of prenatal care may be somewhat overestimated given that prenatal care is not exclusively provided by obstetricians.

<sup>16</sup>In 1986, the average hospital cost per admission in Maryland was within one-half percent of the national average cost per admission (493 J).

OTA's analysis used this amount as the lower bound of the range of net newborn hospitalization costs.

Not only are costs incurred for hospital care in the newborn period, but costs are also incurred for the visits physicians make to newborn babies in the hospital. Data on physician visits to newborns are not available, but several studies and reports from individual institutions indicate that physician charges for care to infants in neonatal intensive care units lie somewhere in the range of 10 to 20 percent of total hospital charges (330,494, 497,736). This range of rates was applied to the Maryland hospital cost data.<sup>17</sup>

#### Cost of Rehospitalizations

Low birthweight infants have higher rates of respiratory, gastrointestinal, and infectious illness than do infants born at normal weights (411,665). McCormick and colleagues reported on rehospitalization rates by birthweight in the first year of life in eight regions of the country in 1978-79 (411). Nineteen percent of low birthweight infants who survived the first year, as compared to 8.4 percent of normal birthweight babies, were rehospitalized at least once during the first year of life. Days spent in the hospital averaged 2.1 for low birthweight infants compared to 0.7 for normal birthweight infants.<sup>18</sup> Thus, each low birthweight birth accounted for an average 1.5 extra days in the hospital after the initial hospitalization.

In 1986, the national average daily cost for a hospital stay was \$535 (26). Thus, the extra cost of rehospitalization in the first year was roughly \$800 per low birthweight birth. This is a conservative estimate for three reasons. First, the daily cost of an infant's hospital stay is probably higher than the average across all patients. Second, the rates of rehospitalization were based on the experience of children who survived infancy. Those who survived the initial hospitalization but did not survive infancy were likely to have very high

rates of hospitalization. Finally, this estimate does not include the fees paid to physicians for visits to rehospitalized infants.

#### Long-Term Health Care Costs

In addition to the extra burden of short-term medical care associated with these children, long-term costs result from early intervention programs,<sup>19</sup> special education, and, sometimes, institutional or foster care.

OTA's analysis makes certain assumptions regarding the types of care that children will receive over their lifetimes and the costs of that care (as specified below). In particular, it is assumed that:

- all infants surviving at 1 year will survive to age 35, regardless of their level of disability;
- costs of care received are calculated only to age 35;
- the severity of developmental disability as evaluated at age 1 is constant through age 35; and
- the costs of services (i. e., early intervention, special education, and institutional or foster care), by level of disability, are the same as the costs of these services provided to severely and moderately mentally retarded people.

Many assumptions were necessary regarding the kinds of care that disabled children would receive over their lifetimes, the costs of providing different levels of care, and the discount rate that should be applied to costs incurred in more distant years. Appendix G contains a detailed description of OTA's analysis of long-term costs and of all assumptions underlying the estimates of long-term costs. In brief the expected net long-term (until age 35) cost of low birthweight is between approximately \$9,000 and \$23,000 per birth. Or, restated, the net long-term savings in

<sup>17</sup>Maryland's hospital cost data were converted to charges by applying the statewide ratio of charges to cost. Physician charges were then calculated from that amount.

<sup>18</sup>This estimate is the average across all births, not just survivors. Estimates were adjusted to account for survival rates in the low and normal weight categories.

<sup>19</sup>Early intervention programs are broadly defined by the Education of the Handicapped Act Amendments of 1986 (Public Law 99-457) as developmental services provided to handicapped infants or toddlers. These services include: family training, counseling, and home visits; special instruction; speech pathology and audiology; occupational therapy; physical therapy; psychological services; case management services; medical services only for diagnostic or evaluation purposes; early identification, screening, and assessment services; and health services necessary to enable the infant or toddler to benefit from the other early intervention services.

health care costs that would be gained by preventing each low birthweight birth (i. e., by moving it to the normal weight category) lie somewhere in the range of \$9,000 to \$23,000.

#### Net Health Care Savings Per Averted Low Birthweight Birth

Table 4-2 summarizes the net incremental costs associated with each low birthweight birth or, alternatively, the net savings associated with the prevention of each such birth. Estimated net savings per averted low birthweight birth range from about \$14,000 to \$30,000.

**Table 4-2.—Net Incremental Health Care Costs of a Low Birthweight Birth**

	Low-cost estimate	High-cost estimate
Initial hospitalization cost:		
• Hospital costs . . . . .	\$3,763	\$ 5,236
• Physician costs . . . . .	475	1,487
Total . . . . .	\$4,238	\$6,723
Rehospitalization costs in first year (hospital costs only) . . . . .	\$ 802	\$ 802
Long-term costs of treating low birthweight . . . . .	\$9,000	<b>\$23,000</b>
Total net incremental costs . . . . .	\$14,040	\$30,525

SOURCE: Office of Technology Assessment, 1988

### Required Level of Effectiveness of Prenatal Care

If Medicaid were extended to all pregnant women in poverty, how effective would early prenatal care have to be for the estimated \$4 million costs to be outweighed by savings from the prevention of low birthweight births? For health care costs to break even, early prenatal care among the 194,000 newly eligible women would have to prevent between 133 and 286 low birthweight births. If the low birthweight rate (i. e., the percentage of live births with birthweights of 2,500 grams or less) in the target population is about 10.2 percent,<sup>20</sup> the number of low birthweight births would have to decline by between

0.7 and 1.4 percent; the low birthweight rate in the target population would have to decline by between 0.07 and 0.20 percentage points to a rate of between 10 and 10.13 percent.

The reduction in the low birthweight rate would be concentrated in the subset of the target population whose use of prenatal care changed as a result of expanded benefits. Overall, 18.5 percent of the newly eligible women, or 35,890 women, are assumed to switch from later or no prenatal care to first-trimester care as a result of the expansion of Medicaid eligibility. If these women began with a low birthweight rate of 10.2 percent, then the low birthweight rate among them would have to decline by between 0.4 and 0.8 percentage points to a rate of between 9.4 and 9.8 percent.

Given the available information on the effectiveness of prenatal care, is it reasonable to expect reductions of this magnitude in the low birthweight rate? The evidence on the impact of earlier or more prenatal care on birthweight suggests that it is. The quantitative results of four studies with relatively good control over self-selection provide some perspective on what can be expected from programs that increase access to early prenatal care for poor women (149,311,600,659).

In a national study of live births in the United States in 1974, Eisner and colleagues found that after controlling for maternal age, marital status, maternal education, prior pregnancy interval, birth order, and prior pregnancy losses, women who received no prenatal care were between two and five times more likely to deliver a low birthweight baby, depending on the mother's race and the number of prior pregnancies, than were women who had received some prenatal care prior to delivery (149). Taking the most conservative estimate, these results imply that receipt of some prenatal care reduces the probability of low birthweight by 50 percent. This difference is many times greater than the required difference in OTA's analysis, but the comparison was between some care and no care, not between first-trimester care and later care. Getting some prenatal care may be more important to birthweight than getting early care.

In a 1981-82 study of births to mothers who were Medicaid recipients in Missouri, the ade-

<sup>20</sup>National data on the low birthweight rate among poor women are unavailable, but the low birthweight rate among women with less than 12 years completed years of schooling is 10.2 percent (709).



quacy of prenatal care (measured by an index based on trimester in which care began and number of visits adjusted for gestational age at birth) was found to be related to the low birthweight rate (659). In 1981, women receiving adequate prenatal care had a low birthweight rate of 10.6 percent as compared to 12.6 percent for women whose prenatal care was judged to be inadequate. (Similar differences were found in 1982. ) Thus, moving from the inadequate to the adequate care category implied a reduction of 16 percent in the probability of a low birthweight birth. This percentage reduction is at least double the percentage reduction in the low birthweight rate among new users of early prenatal care (4 to 8 percent) that is required for net savings to accrue to the health care system. Apart from the fact that all births were to Medicaid recipients, however, this study had no controls for self-selection biases.

Joyce analyzed the low birthweight rate in U.S. counties from 1976 to 1978, controlling for the rate of use of family planning by teenagers, the abortion rate, the availability of neonatal intensive care units, resident's smoking rates, the rate of births to teenagers, the birth rate of older and high-risk women, and the population density of the county (311). For whites, every 1-percent increase in the proportion of women receiving first-trimester care decreased the low birthweight rate by 0.029 percentage points. An increase of 18.5 percent in the percentage of women getting first-trimester care (as predicted in OTA's analysis) would correspond to a decrease of 0.5 percentage points in the low birthweight rate. This is more than twice the percentage point decrease required for health costs to break even in OTA's analysis (i. e., between 0.07 and 0.20 percentage points). Although Joyce's study is a county-level analysis, which can mask relationships occurring at the individual level, its findings strongly support the conclusion that the Medicaid expansion

of prenatal care would be cost-saving to the U.S. health care system if adopted nationally.

In a study of low-income women who gave birth in a Cleveland hospital, a group of women who were eligible for a Maternity and Infant Care project because of their county of residence was compared with a group who resided in a county with similar socioeconomic and demographic characteristics but whose residents were not eligible for the program (600). Almost 48 percent of the program participants registered for care in the first trimester, as compared to 35 percent of women in the comparison group. The low birthweight rate was 11.7 in the program participants and 14.0 in the comparison group. Thus, a difference of 13 percentage points in first-trimester use was associated with a difference of more than 3 percentage points in the low birthweight rate. The decline observed in this study is more than three times the percentage point decline required among new users in OTA's analysis (i.e., between 0.4 and 0.8 percentage points). Of course, some part of the differences may have been due to either more intensive services offered to the program women once they did register or systematic differences in the patient populations (e.g., some pregnant women residing in the county without the program may have been motivated to seek care at a hospital offering good services). The magnitude of the effect, however, seems to leave enough leeway to account for such potential biases.

In summary, the evidence from four studies that relate early receipt of prenatal care to birthweight strongly suggests that the effect size that might be reasonably expected from increasing the use of early prenatal care is at least as great as that required to justify early care on the basis of net savings to the health care system. That early prenatal care will also prevent some infant deaths (though the number cannot be predicted with any certainty) further enhances its cost-effectiveness.

## **ACCESS TO PRENATAL CARE: THE ROLE OF THIRD-PARTY PAYMENT AND ALTERNATIVE FUNDING SOURCES**

The ability to pay for health care services is an important determinant of who receives care (653).

Two major insurance options are available to pay for maternity care. Medicaid is the major public

financing program for pregnant women who are poor. Private insurance also provides maternity care coverage for women at all income levels. Two major financing alternatives to public and private insurance coverage for maternity care are the Maternal and Child Health (MCH) services block grant program and community health centers (CHCs). Available information regarding eligibility, benefits, and reimbursement under each source of funding is summarized below. A broader discussion of these funding sources, particularly as they pertain directly to children, is presented in chapter 3,

## Medicaid

### Eligibility

Medicaid eligibility takes one of two major forms. Historically, automatic categorical eligibility for poor women has been directly tied to eligibility for cash assistance through the AFDC program. In addition, States have the option to cover a wide range of groups through medically needy provisions. Medically needy programs include “. . . people who are not recipients of cash assistance, but who fit into one of the categories of people covered by the cash assistance programs and whose income and assets fall within the medically needy standards or who spend-down, because of their medical bills, to the medically needy standards” (674).

Requirements and options for Medicaid eligibility have gone through a number of important changes during the 1980s. Under the Omnibus Budget Reconciliation Act of 1981 (OBRA-81) (Public Law 97-35), the changes resulted in the loss of Medicaid coverage and eligibility for substantial numbers of poor people. Between 1975 and 1984, the percentage of the poor covered by Medicaid dropped from 63 to 46 percent (544). In 1984 and again in 1986 and 1987, however, Congress enacted legislation that reversed some of the Medicaid eligibility restrictions under OBRA-81 (104,544). Medicaid coverage is currently mandated for all pregnant women with family incomes and resources below State AFDC financial eligibility requirements. OBRA-87 (Public Law 100-203) allows States the option of providing maternity care benefits to all pregnant women whose family incomes are at or below 185 percent of the Federal poverty level.

Anecdotal data suggest that even when women are eligible, the Medicaid enrollment process itself can be a formidable barrier to the receipt of timely care. States have 45 days to process an application for Medicaid, but additional delays can be encountered when applications are incomplete or when other impediments arise. A General Accounting Office survey of poor women in 32 communities who gave birth found that about 6 percent of women who attempted to enroll for Medicaid experienced long delays in receiving notification of eligibility. The median time between application and a determination of eligibility for these women was 8 weeks (653). Furthermore, many health care providers have been reluctant to offer care to women in anticipation of their eligibility for Medicaid, because providers have feared retroactive denial of eligibility and nonpayment for the services rendered (185). Under OBRA-86, a “qualified provider” can provide services to women presumed to be eligible and be guaranteed of Medicaid reimbursement even if eligibility is ultimately denied. “Qualified” providers include health departments, hospitals, and clinics. The “presumptive eligibility” clause is not applicable to private physicians’ practices. Thus, the presumptive eligibility clause of OBRA-86 appears to channel pregnant women who are probably eligible for Medicaid into sources of prenatal care other than private practices,

Some local providers have tried to institute policies that help overcome barriers to the timely receipt of prenatal care. One study found that when hospitals provide resources to help uninsured patients enroll in Medicaid and verification procedures are relaxed, poor women initiate care earlier in pregnancy (309). Barriers in the Medicaid enrollment process may encourage women to seek care through non-Medicaid programs and may in part explain why poor women who should be eligible for Medicaid sometimes fail to enroll and remain uninsured.

### Benefits

Under Medicaid, some services are mandated, while others are optional. Also, States may place limits on the extent of both required and optional services which can be billed to Medicaid. Required services include inpatient and outpatient hospi-

tal care, physician care, laboratory tests, X-rays, family planning, and nurse midwife services<sup>21</sup> among others. Clinic services, prescription drugs, diagnostic and screening services, and dental care are optional services.

Some observers contend that these optional services are important features of comprehensive prenatal care and, in many States, are unavailable (209). In 1985, for example, five States did not cover services provided by clinics, a major source of health care for poor women. Ten States set limits on the number of outpatient hospital visits<sup>22</sup> and physician visits that could be reimbursed by Medicaid; these limits were less than the 12 to 13 prenatal care visits recommended by the American College of Obstetricians and Gynecologists or would have precluded frequent visits during the third trimester (209). Pregnant adolescents may be able to avoid some of these restrictions on benefits by virtue of their eligibility for extended care through the Early and Periodic Screening, Diagnosis, and Treatment (EPSDT) program within Medicaid. It is unclear, however, how many States utilize EPSDT to provide more comprehensive services to pregnant teens (209).

The Consolidated Omnibus Budget Reconciliation Act of 1985 (COBRA) (Public Law 99-272) expanded service-related benefits for pregnant women in three ways (104). First, it mandated an additional 60 days postpartum coverage for all women whose Medicaid eligibility was based solely on their pregnancy status. Second, COBRA permitted States to provide enriched services to pregnant women without extending such benefits to other Medicaid eligibles. Finally, it permitted case-management services (e. g., outreach, referral, and service coordination) to be provided to recipients.

### Physician Participation in Medicaid

**Physicians' refusal to accept Medicaid reimbursement** for maternity care in private practice settings has been widely considered to be a ma-

ajor barrier to poor women's obtaining prenatal care. Only one recent study directly assessed this issue. In a 1983 national probability sample survey of private physicians likely to provide reproductive health services, the Alan Guttmacher Institute found that among physicians who actually provide obstetric care, 56 percent reported that they accepted Medicaid reimbursement (473).<sup>23</sup>

Reasons given for low Medicaid participation rates among physicians include low reimbursement rates and onerous administrative procedures. Data on physician participation presented in appendix E clearly indicate that fees for obstetrical care paid by Medicaid are losing ground to private fees.

Furthermore, payment by Medicaid tends to be delayed because of administrative procedures. Most States reimburse for Medicaid-financed maternity care through a global fee covering prenatal, delivery, and postpartum care. Physicians generally cannot bill Medicaid for such care until after the delivery, a requirement that in some cases delays reimbursement for a year or more. Additionally, in some States, doctors must receive prior authorization for the delivery of certain types of services, thereby increasing the paperwork involved in serving Medicaid recipients (431).

### Private Insurance

Private health insurance in the United States is largely provided through employers. For women who work, such insurance is often available directly; for other women, it maybe available indirectly via family coverage purchased through the workplace by a parent or spouse. In 1984, about 67 percent of women aged 15 to 44 were covered by a group health insurance plan (209). Group coverage is strongly related to income level. In 1984, over 80 percent of women with family incomes at or above 250 percent of the Federal poverty level were covered by a group plan, as compared to only 17 percent of women with family incomes at or below the Federal poverty level.

<sup>23</sup>Other data are also available, but they do not specifically address physician acceptance of Medicaid reimbursement for maternity care. See app. E for a review of the evidence on physician participation in Medicaid.

<sup>21</sup>A State's Medicaid plan must provide coverage of nurse midwife services for the categorically needy to the extent that nurse midwives are authorized to practice under State law or regulation (42 CFR 440.210).

<sup>22</sup>In a survey of 30 States, Rosenbaum (542) found that 24 States also placed some limit on covered inpatient hospital days.

In 1978, Congress passed the Pregnancy Discrimination Act (Public Law 95-555), changing requirements for maternity care benefits in group health insurance plans. This law required employers who offered health insurance to provide maternity care benefits in the same manner. Firms with fewer than 15 employees and individual insurance policies were exempted from the law's requirements (209).

Maternity care benefits vary from policy to policy, although detailed information on these benefits is sketchy (209,543). Most insurance plans provide some coverage for laboratory tests and drugs, but information regarding coverage for special diagnostic procedures such as ultrasound or amniocentesis is generally unavailable. Data on the number of prenatal care visits that insurance plans will reimburse are also unavailable. Hospital room and board charges usually make up the bulk of maternity care expenses. In 1980, almost all coverage for such charges was limited by a deductible or coinsurance requirements or had an individual benefit maximum (105).

### **Alternatives to Public and Private Insurance**

Some poor women are able to obtain prenatal care without the benefit of Medicaid or private insurance coverage. Typically, they must rely on health care providers who offer reduced fee schedules or who provide a certain amount of uncompensated care. Services for many poor women are provided by CHCs and are also often financed through the MCH block grant program.

### **Maternal and Child Health Services Block Grant Program**

The MCH block grant program represents the major Federal maternity care funding alternative to public and private insurance. The MCH block grant consolidated seven health programs for women and children: maternal and child health, services for disabled children receiving supplemental security income, prevention of lead poisoning, genetic diseases, sudden infant death syndrome, hemophilia treatment, and prevention of adolescent pregnancy (209). Federal MCH block grants are awarded to the States, which in turn provide

grants directly to public and private providers of maternal and child health care or crippled children's services (209,541).

States have wide latitude in establishing who is eligible for services and what those services can be. Expenditures for specific services (e.g., prenatal care v. well-child care) under the MCH block grant program are nearly impossible to identify, largely because the Federal Government does not require the collection or reporting of pertinent data. This problem is exacerbated by the fact that there are no requirements regarding minimum services and eligibility. As a consequence, very little is known about who receives what types of services under the MCH block grant (209).

### **Community Health Centers**

The CHC program is one of the largest categorical grant programs, providing maternal and child health care, as well as other services, to residents of medically underserved areas (224). In fiscal year 1985, CHCs received \$383 million in Federal funding (772) (see ch. 2). Rosenbaum (543) reports that nearly half of all CHC users are completely without health insurance. In addition, over one-quarter (28.6 percent) of CHC users are in their childbearing years.

CHCs offer a wide range of services (224). Certain services, called "primary health services," are provided by all CHCs. These include preventive health services (e.g., perinatal care, family planning), diagnostic care, emergency care, and transportation. Other services, called "supplemental health services," are provided at the grantee's option. Such services include hospital care, health education, and dental and vision care, among others. Charges for care received at CHCs are usually assessed on a sliding fee scale, with families living below the Federal poverty level eligible for free care.

### **Strengths and Limitations of Alternative Mechanisms for Financing Maternity Care**

A critical question for the development of policy regarding prenatal care is which approach is the most effective in increasing access to prenatal care services:

1. an insurance program such as Medicaid?
2. Federal grants to States, which in turn distribute funds to local providers, such as the MCH block grant? or
3. direct grants to health care providers such as the current CHC program model?

## CONCLUSIONS

Taken together, the weight of the evidence on both routine prenatal care and augmented prenatal care suggests that birth outcomes can be improved when women receive earlier or more comprehensive prenatal care. Although available studies of the effectiveness of prenatal care generally support the contention that prenatal care does improve birth outcomes, they do not provide definitive quantitative estimates of these effects.

OTA examined how costs to the U.S. health care system (not just to Medicaid) and birth outcomes would be affected by a policy of making pregnant women in poverty universally eligible for Medicaid. Such a policy could be implemented if every State were to expand eligibility to all pregnant women with incomes up to the poverty line, or if Congress were to require, rather than permit, States to provide such coverage. OTA calculated what percentage reduction in the low birthweight rate would be necessary to balance the extra prenatal care costs with equal savings in short- and long-term health care costs. This estimate was then compared to available evidence on the effectiveness of prenatal care to determine

Which approach encourages the most effective provision of maternity care? OTA was unable to locate any studies that addressed these important questions.

whether the estimate lies within reasonable bounds.

Overall, OTA found, offering Medicaid eligibility to all pregnant women in poverty would cause an additional 18.5 percent of women in this category to initiate prenatal care in the first trimester of pregnancy. Nationally, the extra prenatal care would cost about \$4 million per year. Expected short- and long-term savings in health care costs associated with the prevention of each low birthweight birth are so great (between \$14,000 and \$30,000), however, that prenatal care would need to have only marginal effects on birthweight to be justified on cost grounds alone. The required level of effectiveness for the breakeven point is well below the order of magnitude of the effects found in several reasonably well-designed studies of prenatal care. In addition, by reducing the incidence of low birthweight, better prenatal care for poor women would also save some (though relatively few) infant lives, and prenatal care may have effects on infant mortality independent of its effects on birthweight.

Chapter 5

# **Newborn Screening for Congenital Disorders**

# CONTENTS

	<i>Page</i>
<b>Introduction</b> .....	<b>93</b>
<b>Factors Affecting the Effectiveness of Newborn Screening</b> .....	<b>97</b>
<b>Percentage of Affected Infants Detected</b> .....	<b>98</b>
<b>Organization and Management of Newborn Screening Services</b> .....	<b>98</b>
<b>Timing and Number of Newborn Blood Specimens</b> . .....	<b>100</b>
<b>Laboratory Performance: Quality Assurance and Proficiency Testing Programs</b> . . . . . +.....	<b>102</b>
<b>Cost-Effectiveness of Seven Newborn Screening Strategies.</b> . .....	<b>103</b>
<b>Components of OTA's Cost-Effectiveness Analysis</b> . .....	<b>105</b>
<b>Findings of the Base Case Analysis</b> . . . . .	<b>106</b>
<b>Components and Findings of the Sensitivity Analysis</b> . . . . .	<b>108</b>
<b>Conclusions</b> . . . . .	<b>109</b>
<b>Costs of Laboratory Testing for Four Additional Disorders</b> . . . . .	<b>111</b>
<b>Biotinidase Deficiency</b> . . . . .	<b>111</b>
<b>Sickle Cell Anemia</b> . . . . .	<b>112</b>
<b>Cystic Fibrosis</b> . . . . .	<b>112</b>
<b>Congenital Adrenal Hyperplasia</b> . . . . .	<b>112</b>
<b>Financing and Reimbursement for Newborn Screening and Treatment</b> . .....	<b>112</b>
<b>Conclusions</b> . . . . .	<b>4. ... &lt;114</b>

## Box

<i>Box No.</i>	<i>Page</i>
<b>s-A. Process of Newborn Screening and Treatment.</b> .....	<b>97</b>

## Figure

<i>Figure No.</i>	<i>Page</i>
<b>s-1. Newborn Screening Strategies Compared in OTA's Cost-Effectiveness Analysis</b> . . . . .	<b>104</b>

## Tables

<i>Table No.</i>	<i>Page</i>
<b>5-1. Nine Congenital Disorders Currently Detectable by Newborn Screening</b> . . .	<b>94</b>
<b>5-2. Effectiveness of Newborn Screening and Early Treatment for Nine Congenital Disorders</b> . . . . . + .....	<b>95</b>
<b>5-3. Percentage of Affected Infants Detected by Newborn Screening for Five Congenital Disorders</b> . . . . .	<b>99</b>
<b>5-4. Effectiveness and Health Care Savings of Newborn Screening Strategy I Compared to No Screening.</b> .....	<b>107</b>
<b>S-S. Incremental Effectiveness and Health Care Costs of Newborn Screening Strategies Compared to Strategy I</b> .....	<b>107</b>
<b>5-6. Sensitivity Analysis: Net Health Care Savings and Number of Cases Detected by Strategy I Compared to No Screening.</b> . . . . .	<b>110</b>
<b>5-7. Sensitivity Analysis: Incremental Effectiveness and Health Care Costs of Newborn Screening Strategies Compared to Strategy I</b> . . . . .	<b>110</b>

# Newborn Screening for Congenital Disorders

## INTRODUCTION

The screening of large populations of newborns for congenital disorders began as a public health activity in 1961 with screening for phenylketonuria (PKU). PKU, an inherited disorder of metabolism of the amino acid phenylalanine, occurs in about 1 in 10,000 to 1 in 15,000 infants and is associated with severe mental retardation unless treated. The goal of newborn screening for this disorder is to detect the condition in the first week of life, confirm the diagnosis, and initiate treatment before 2 to 4 weeks of age. If the treatment is begun by this time and maintained at least throughout the child's development, the irreversible mental retardation that is the natural consequence of untreated PKU can be avoided.

Newborn screening has generally been limited to diseases such as PKU that are not clinically recognizable in time to treat before severe and irreversible consequences have occurred (57,442). These are diseases that are present throughout the life of an affected individual, do not get better (and often worsen) with time, and can result in severe mental retardation, physical disabilities, and even sudden death if untreated in the first days or weeks after birth. Although the number of conditions that fall into this category is small, and each of these conditions is relatively rare, newborn screening followed by early and sustained treatment can make the crucial difference in affected infants. Information about the incidence and natural course of PKU, congenital hypothyroidism, galactosemia, maple syrup urine disease (MSUD), and several other disorders that can be detected through tests on a blood specimen taken in the neonatal period are summarized in table s-1. I

<sup>1</sup> More detailed information about these and other disorders is presented in app. H.



Photo credit: March of Dimes Birth Defects Foundation

Screening newborns for certain congenital disorders can serve a critical function — alerting physicians to the need for treatment of infants who may not yet show signs or symptoms of a disorder.

In most States, newborn screening is mandated by law, except in the case of parental refusal on religious or other grounds. In a few States (North



**Table 5-1.—Nine Congenital Disorders Detectable by Newborn Screening**

Disorder	Approximate Incidence per 100,000 births	Problem	Natural course without adequate treatment
Phenylketonuria (PKU)	7	Impaired metabolism of the amino acid phenylalanine	Severe mental retardation, shortened lifespan
Congenital hypothyroidism (CH)	29	Deficiency of the hormone thyroxine needed for brain development and physical growth	Mental retardation, physical abnormalities, premature death, abnormal growth
Galactosemia (GA)	2	Deficiency of the enzyme needed to metabolize galactose, a type of sugar in milk	Life-threatening septicemia and liver damage in infancy; mental retardation and cataracts in survivors; leads to death if untreated
Maple syrup urine disease (MSUD)	0.4	Deficiency of the enzyme needed to metabolize branched-chain amino acids	Life-threatening acidemia and neurologic dysfunction in infancy, mental retardation in few survivors; leads to death if untreated
Homocystinuria (HC)	0.5	Deficiency of the enzyme needed to metabolize the amino acid homocystine	Developmental retardation, dislocation of ocular lenses, life-threatening thrombosis, skeletal manifestations
Biotinidase deficiency (BD)	3	Deficiency of the enzyme needed to metabolize the B vitamin biotin	Life-threatening neurologic dysfunction, developmental delay and hearing loss in survivors (milder and asymptomatic cases may occur)
Sickle cell anemia (SCA)	32	Abnormality of the red blood cells that causes them to be sickle-shaped	Life-threatening infections especially in infancy, chronic hemolytic anemia and vaso-occlusive crises in childhood and adulthood, risk of premature death, shortened lifespan
Cystic fibrosis (CF)	40	Disorder of the exocrine glands whose cause is unknown	Poor growth, digestive problems, life-threatening chronic obstructive lung disease with recurrent pneumonia; risk of death in early adulthood
Congenital adrenal hyperplasia (CAH)	5	Inability to produce the hormones needed to manage stress and to control, salt content of tissues, combined with the excessive buildup of male hormones	Life-threatening salt-wasting crises for some in infancy, reproductive dysfunction, and abnormal physical development

SOURCE Office of Technology Assessment, 1988

Carolina, Delaware, Vermont, and the District of Columbia) newborn screening is voluntary (32). Newborn screening for PKU and another condition—congenital hypothyroidism—is now conducted in all 50 States and the District of Columbia. Congenital hypothyroidism, resulting in a deficiency of the hormone thyroxine, is much more common than PKU, affecting about 1 in 3,000 to 1 in 4,000 infants. Like PKU, this disorder can cause permanent brain damage if untreated or treated too late. In addition to offering the tests for PKU and congenital hypothyroidism, some States offer tests for other disorders: 35 States test for galactosemia, 24 States test for MSUD, and 22 States test for homocystinuria (640a).<sup>2</sup> Galactosemia, MSUD, and homocystinuria are less

common than PKU, but all of them have serious adverse consequences if left untreated.

Recently, the scope of routine newborn screening has expanded to include tests for several additional diseases, some of which are more common in certain populations than PKU, but not all of which are as treatable as PKU. An increasing number of programs have begun pilot screening projects for biotinidase deficiency and sickle cell anemia, and a small number of programs are beginning to screen for cystic fibrosis and congenital adrenal hyperplasia. OTA found that as of 1986, approximately 18 States were screening for biotinidase deficiency, 9 States were offering tests for sickle cell anemia, 3 States were offering tests for cystic fibrosis, and at least 2 States were screening for congenital adrenal hyperplasia. Information about the effectiveness of newborn screening and treatment for these and other congenital disorders is presented in table 5-2.

<sup>2</sup>A few programs also offer screening tests for a number of other rare metabolic disorders, such as tyrosinemia or histidinemia.

**Table 5-2.—Effectiveness of Newborn Screening and Early Treatment for Nine Congenital Disorders**

Disorder	Optimal screening time after birth	Treatment following screening	Effectiveness of screening and early treatment
Phenylketonuria (PKU)	3-5 days	Phenylalanine-restricted dietary products continued indefinitely	Normal mental and physical development
Congenital hypothyroidism (CH)	3-5 days	Thyroxine supplements indefinitely	Normal mental and physical development
Galactosemia (GA)	Before 5 days (or in cord blood taken at birth)	Elimination of galactose-containing foods indefinitely	Life saved in neonatal period, normal mental and physical development in majority of cases. coordination and speech problems; gonadal failure in some females
Maple syrup urine disease (MSUD)	1-5 days	Dietary restriction of branched-chain amino acids indefinitely	Life saved in neonatal period normal mental and physical development, risk of sudden death at a later age in some cases
Homocystinuria (HC)	3-4 weeks	Dietary restriction of methionine and supplementation of cystine and vitamin B <sub>6</sub> indefinitely	Normal mental development, some physical problems may remain
Biotinidase deficiency (BD)	Before 5 days	Oral biotin supplements	Life saved in neonatal period for some or avoidance of neurologic damage
Sickle cell anemia (SCA)	1st week	Prophylactic penicillin and pneumococcal vaccine, ongoing supportive therapy	Reduce risk of death in infancy and early childhood from complications of infection
Cystic fibrosis (CF)	1st week	Prophylactic vitamin and salt supplements, pancreatic enzyme replacement therapy, antibiotics, supportive respiratory therapy	May improve growth and development in childhood, long-term effects under investigation
Congenital adrenal hyperplasia (CAH)	2-5 days	Intravenous salt solution, hormone therapy	Life saved in neonatal period for some, aid sex assignment in infant girls with CAH. normal sexual development

SOURCE: Office of Technology Assessment 1988

In some cases, infants with biotinidase deficiency and some forms of congenital adrenal hyperplasia are at risk of sudden death if not immediately treated, often before physicians are able to make clinical diagnoses of their conditions. In these situations, newborn screening can serve a critical function—alerting physicians to the need for treatment in infants who may not yet show specific signs of their conditions. In general, however, little is known about the natural history of either biotinidase deficiency or congenital adrenal hyperplasia. For example, it is not known how many infants with biotinidase deficiency are at risk of sudden death and how many have a less severe form of the disease that does not require treatment. Congenital adrenal hyperplasia takes at least two forms, one requiring immediate life-sustaining treatment and another form that does not require such treatment and may be diagnosed clinically. Although some infants with biotinidase deficiency and congenital adrenal hyperplasia can certainly be helped by early diagnosis through

newborn screening, there is still not enough information available to judge whether screening of all infants for either of these conditions is desirable, and how the benefits of such screening compare to the benefits from newborn screening for other treatable conditions.

For sickle cell anemia and cystic fibrosis, treatment that will entirely prevent the major long-term disabilities characteristic of these disorders does not exist. In the case of sickle cell anemia, however, newborn screening may have an important intermediate goal. A certain percentage of infants with sickle cell anemia are at risk of overwhelming infection and sudden death in the first few years of life. If their sickle cell disease is identified before infection occurs, affected infants can be given prophylactic antibiotics that significantly reduce the risk of infection and lower the overall mortality rate from the disease in early life (198). For patients who have passed this critical period, there is no hard evidence that screening and diag-

nosis in the first few weeks of life leads to improved long-term survival. Nevertheless, some observers think that the effectiveness of prophylactic antibiotics to prevent infection in infants with presymptomatic cases of sickle cell anemia is probably a sufficient reason to include testing for sickle cell anemia in routine newborn screening. The issues of the long-term value and cost-effectiveness of early diagnosis and treatment of sickle cell anemia, however, remain to be resolved.

A similar situation exists with respect to newborn screening for cystic fibrosis. In recent years, earlier and more intensive treatment following clinical diagnosis of patients with cystic fibrosis has contributed to a generally longer survival among these individuals, who now live to early adulthood rather than dying in early childhood as patients did several decades ago. A variety of clinical observations suggest that early awareness of cystic fibrosis allows improvement in certain aspects of patients' physical condition—notably, in their early nutritional status (472). The major factor in long-term survival of patients with cystic fibrosis, however, is chronic lung disease; whether newborn screening and even earlier treatment will improve survival above the current average survival of 20 to 25 years is not known, although a controlled clinical trial being conducted in Wisconsin may help resolve the issue.<sup>3</sup>

The next section of this chapter describes the factors that influence the effectiveness of newborn screening. There are two distinct aspects of the overall effectiveness of newborn screening in detecting and treating affected infants. One aspect is the effectiveness of the screening test and the

<sup>3</sup>The controlled clinical trial being conducted in the Wisconsin Cystic Fibrosis Centers is seeking to evaluate the potential pulmonary benefits, as well as the potential psychological risks, of newborn screening for cystic fibrosis (166). One-half the newborn population of the State will be screened at random, and newborns identified as having cystic fibrosis will be enrolled in a comprehensive evaluation and treatment protocol. At the end of 3.5 years, infants identified as having cystic fibrosis by the newborn screening test will be compared with age-matched patients diagnosed through conventional medical channels, and their health status will be monitored for at least another 3.5 years. Any differences in pulmonary status between the two groups at the end of this period may then be assumed to have resulted from the age at which the children were first diagnosed. Where possible, a controlled clinical trial such as this can be valuable in assessing the benefits and risks of a particular screening test before it is adopted on a routine basis in newborn screening programs.

overall screening process in detecting affected infants in need of treatment. This aspect includes how well the screening program coordinates abnormal laboratory findings with confirmatory diagnosis and initiation of adequate treatment. Another aspect is the efficacy of available treatments. Without effective treatment available to alter the natural course of the disease, early screening would be ineffective at best, and possibly even harmful. The discussion below addresses mainly the first aspect, but several issues pertaining to the treatment of specific diseases are discussed in appendix H and elsewhere in this chapter.

Using the best information available on the effectiveness and costs of screening for specific disorders, OTA performed a cost-effectiveness analysis of a basic strategy for newborn screening compared to no screening and of six expanded strategies compared to the basic strategy. The basic strategy consists of a one-specimen testing process to identify cases of PKU and congenital hypothyroidism. The expanded strategies include testing for additional selected congenital diseases and more intensive testing for PKU and congenital hypothyroidism. All of the various screening strategies involve combinations of tests for two or more of the following five disorders: PKU, congenital hypothyroidism, homocystinuria, galactosemia, and MSUD.

Tests for biotinidase deficiency, sickle cell anemia, cystic fibrosis, and congenital adrenal hyperplasia are not included in the strategies considered in the cost-effectiveness analysis. An increasing number of newborn screening programs have begun pilot screening projects for biotinidase deficiency and sickle cell anemia, and a small number of such programs are beginning to screen for congenital adrenal hyperplasia and cystic fibrosis. However, there is insufficient information on the long-term costs and effects of screening for these conditions to analyze the cost-effectiveness of strategies involving tests for these disorders. Nevertheless, this chapter does provide information on the costs of detecting these disorders in ongoing screening programs.

The chapter also discusses the financing of newborn screening and treatment programs. It emphasizes, in particular, the recent changes in the overall level of Federal support for such programs.

## FACTORS AFFECTING THE EFFECTIVENESS OF NEWBORN SCREENING

As described in box 5-A, newborn screening seeks to identify biochemical abnormalities that suggest the presence of disease in affected but as yet asymptomatic infants. Infants who test positive in the initial screening test can be evaluated further to diagnose the specific disorder and to determine the best mode of therapy. Since for most of the disorders targeted by newborn screening, treatment must begin in the first 2 to 3 weeks of life (as in PKU and congenital hypothyroidism) or even the first few days of life (as in galactosemia, MSUD, and congenital adrenal hyperplasia), there is a premium on identifying affected cases early, rapidly, and unambiguously.

The effectiveness of newborn screening in identifying affected infants depends in part on the abil-

ity of the screening program to collect blood specimens from all infants and to perform the tests properly and in time to initiate treatment. Potential errors in the overall screening process include not collecting blood specimens as needed; losing specimens in transit; collecting specimens too early or too late; reporting errors; and lack of adequate followup testing. Thus, the organization and management of newborn screening services, the timing and number of newborn blood specimens, and laboratory performance have major bearing on the effectiveness of newborn screening. Even without errors such as those just mentioned, however, there would still be upper limits on the technical ability of a newborn screening program to detect all affected infants, since none

### Box 5-A.—Process of Newborn Screening and Treatment

The process of newborn screening involves collecting a few drops of blood from an infant's heel onto specially designed filter paper with accompanying information including the infant's name, date of birth, and other relevant data. The specimen is usually collected just prior to the infant's discharge from the hospital nursery or, for nonhospital births, during the first week of life.

Once the blood spots have dried, the filter paper is sent to a screening laboratory where specimens are analyzed using procedures and equipment designed to handle many samples simultaneously. (A medium-sized newborn screening program may screen 40,000 to 50,000 infants annually; larger programs, particularly those regional in scope, screen 100,000 to 150,000 specimens annually.) The distinction between affected and normal infants is either qualitative (presence or absence of a protein, for example) or quantitative (greater or lesser concentration of a chemical in the blood), although the distinction is made within certain bounds of sensitivity and specificity.<sup>1</sup> The test procedure used in newborn screening has to be sufficiently reliable and valid for use on a large-scale basis (280,281).

If the screening test result reveals an abnormality, the program staff notifies the family's physician or refers the family to a qualified specialist. The screening program may or may not be responsible for coordinating diagnostic services or treatment for infants with abnormal screening results. Followup services typically involve long-term treatment and evaluation and are guided by various health professionals, including pediatricians, geneticists, nutritionists, nurses, and social workers. The screening program may develop specific protocols for the treatment of unusual or rare diseases (378). It is usually the responsibility of the screening program to keep long-term records of the screening results and actions following identification of affected infants.

The initiation of timely treatment and provision of adequate followup requires close coordination among the various components of the screening program: the hospital of birth, the screening laboratory, the infant's family and physician, and specialists at an appropriate diagnostic and treatment center who oversee long-term treatment and monitoring. Therapy for diseases detected through newborn screening usually continues throughout an individual's lifetime.

<sup>1</sup>Sensitivity is a measure of the accuracy of a screening or diagnostic test in correctly identifying those who have the disease in question; specificity is a measure of the accuracy of such a test in correctly identifying those who do not have the disease.

of the tests have complete sensitivity (i.e., the ability to classify correctly all affected infants as affected). Therefore, this section focuses not only on technical sensitivity of the tests used in newborn screening, but also on the organization and delivery of screening services that affect the effectiveness of newborn screening in practice.

### Percentage of Affected Infants Detected

Data on the overall sensitivity and specificity of the tests for PKU and congenital hypothyroidism (two tests which have been in use for over 10 years) are not collected or evaluated on a national basis. The accuracy of these newborn tests in identifying blood samples with abnormal levels of phenylalanine or thyroxine, however, is generally considered to be very good. Estimates of the sensitivity and specificity of the tests for PKU and congenital hypothyroidism in practical use have been reported by various individual newborn screening programs, but the estimates vary, depending in part on the size of the program and how the tests are conducted. Furthermore, biological variation among individuals with a given condition makes it difficult to distinguish precisely between normal and abnormal findings, and the same result can be interpreted in different ways in different laboratories. In the case of tests to detect PKU, for example, the sensitivity depends on factors such as the cutoff point above which a sample is considered to have an abnormal amount of phenylalanine and also on the age of the infant when the blood sample was taken.

If there is limited information on the sensitivity of newborn screening tests for PKU and congenital hypothyroidism, there is even less information on the sensitivity of the newer tests for other conditions such as biotinidase deficiency, cystic fibrosis, and congenital adrenal hyperplasia. Like missed cases of PKU and congenital hypothyroidism, missed cases of these other conditions do not necessarily come to the attention of the appropriate State agency or to a central national office such as the Centers for Disease Control (CDC).

Lacking accurate data on sensitivity in a technical context as well as a broader context, OTA consulted with experts in newborn screening pro-

grams and in academic genetics and pediatrics departments to develop estimates and ranges for the percentage of affected infants detected by five newborn screening tests. Estimated incidence rates for PKU, congenital hypothyroidism, galactosemia, MSUD, and homocystinuria, along with estimated percentages of affected infants found by these tests on first and second specimens are shown in table 5-3. The estimates in the table reflect these experts' consensus regarding the technical sensitivity of the tests plus practical considerations in applying the tests to large populations. In MSUD testing, for example, the sensitivity of the test may generally be high, but MSUD is so rapidly fatal that, in practice, the test may not always be performed and reported in time to initiate effective treatment.

### Organization and Management of Newborn Screening Services

Canada and the United States are the only developed countries offering newborn screening that do not have a *national* screening program.<sup>4</sup> In the absence of a national newborn screening program or national set of minimum standards, each State has taken a slightly different approach to providing screening services. A few States have joined with neighboring States to form regional programs that together account for the screening of about 20 percent of births each year (279). Currently, there are three regional programs in the United States:

1. the New England regional program (covering Massachusetts, Rhode Island, Connecticut, Maine, and New Hampshire);
2. the Rocky Mountain States regional program (covering Colorado, Arizona, and Wyoming); and
3. the Pacific Northwest regional program (covering Oregon, Idaho, Nevada, and Alaska).

Although each of these regional programs has a central screening laboratory and coordinating center clinical followup services are provided at local medical centers.

<sup>4</sup>Approximately 30 countries outside the United States also offer newborn screening services for various diseases (640a).

**Table 5-3.—Percentage of Affected Infants Detected by Newborn Screening for Five Congenital Disorders<sup>a</sup>**

Disorder	Incidence of the disorder		Percentage of affected cases found (sensitivity)			
			On first screening test		On second screening test	
	Median	Range	Median	Range	Median	Range
Phenylketonuria (PKU)	1 in 12,000	1 in 10,000 to 1 in 15,000	960/0	94-97%	99 %/0	98-1 00°/o
Congenital hypothyroidism (CH)	1 in 3,500	1 in 3,000 to 1 in 4,000	93 %/0	90-95 %/0	99 %/0	95-1 00 %/0
Galactosemia (GA)	1 in 62,000	1 in 40,000 to 1 in 80,000	850/0	80-900/0	—	—
Maple syrup urine disease (MSUD)	1 in 227,000	1 in 200,000 to 1 in 300,000	850/0	80-900/0	—	—
Homocystinuria (HC)	1 in 150,000	1 in 100,000 to 1 in 300,000	—	.	80 0/0	75-850/0

<sup>a</sup>OTA solicited the estimates presented in this table for use in the cost-effectiveness analysis of seven newborn screening strategies, which is presented in this chapter. See text for discussion of sources.

SOURCE: Office of Technology Assessment, 1988.

The majority of infants—about 71 percent—are covered by newborn screening programs in individual States. Most State newborn screening programs do have a centralized screening laboratory, but only some (e.g., California) have an organized program of services linking the laboratory with followup, treatment, and monitoring. A few States, together accounting for about 9 percent of all births, operate without a central laboratory or a centrally organized program. These States (e.g., Nebraska, South Dakota, Oklahoma, and Hawaii) rely on an informal network of individual families, physicians, and a combination of public and private laboratories to provide screening and followup.

Because of the particular requirements and difficulties inherent in newborn screening, it seems reasonable that a coordinated system of services would provide the optimal organization for ensuring that all infants are satisfactorily screened and that affected infants are followed up and treated. In a 1975 publication, the National Academy of Sciences recommended the development in the United States of regional screening programs based on an area's birth rate rather than its State boundaries, particularly in areas where low population densities and low budgets would restrict access to high-quality screening services (442). Other sources have also recommended centralizing laboratories and coordinating various components of screening programs (e.g., 31,53). There is no ongoing system in place, however,

to assist States in implementing these recommendations and in developing coordinated screening programs.

In some areas, the lack of a coordinated network of services may be reducing the overall effectiveness of newborn screening by putting infants at risk for not being screened or for not receiving appropriate treatment. There are no national data on the number of infants at risk, however, because there is no central system for collecting comprehensive data with which to monitor and compare the outcomes of newborn screening in the State and regional programs. If a system were to be established, several specific indicators of effectiveness could be used to evaluate the performance of screening programs—e.g., the percentage of infants screened in a given area, the time that elapses between the completion of the screening tests and the initiation of treatment, and the frequency of “errors” in the process (from collecting unsatisfactory specimens to actually failing to identify an affected child).

A recent study of errors in the process and analysis of newborn screening specimens in Oregon's program suggests that collecting and monitoring such data on a national basis may be important (647). Using data from a computer-based surveillance system designed to track individual infants through the screening process and to monitor screening practices of individual hospitals, birth centers, and home deliveries, Tuerck and colleagues found that over one-half (58 percent) of

the 23,717 specimens collected in Oregon over a recent 4-month period were submitted with one or more screening practice “errors” (647). Any one of these errors, if uncorrected, could have allowed an affected child to go undetected and untreated or could have caused a serious delay in diagnosis and treatment. The five categories of errors, in order of frequency were:

1. 28.2 percent of the specimens had omissions of demographic information on the screening card (e. g., no name or unreadable information);
2. 27.7 percent of the specimens were taken at suboptimal times (e. g., the first one taken before 24 hours of age and the second taken after 14 days of age);
3. 22.9 percent were not retested as required by the State of Oregon;
4. 16.2 percent of the specimens took longer than 5 days to go from the birthing facility to the screening laboratory; and
5. 0.6 percent were unsatisfactory for testing, usually caused by poor techniques for blood collection.

A retrospective study that surveyed screening laboratory directors in 49 States identified 76 missed cases of PKU and congenital hypothyroidism that occurred during the history of the programs (279). The primary causes identified were the following: laboratory procedures (45 percent); errors in followup (16 percent); specimen collection errors, mostly the lack of an initial specimen (14 percent); false negative results<sup>5</sup> due to biologic variation in disease expression (11 percent); and unidentified causes (14 percent). Although the investigators reported that 76 missed cases was probably an underestimate of the actual number of missed cases, these data do give a rough indication of the types of errors (mostly “human” errors) that allow affected infants to escape detection and treatment.

<sup>5</sup> false negative is an affected person lease incorrectly identified by a test as not having the condition.

## Timing and Number of Newborn Blood Specimens

### Optimal Timing of Blood Specimen Collection

The optimal time for collecting a blood specimen for newborn screening during the newborn hospitalization<sup>6</sup> depends on the characteristics of the disorders for which infants will be screened. The optimal time for collection is the earliest point at which the biochemical markers for the targeted disorders are present in the blood in high enough or low enough amounts (depending on the disorder) to identify the disorders accurately. As affected infants progress, these markers become more and more unmistakable, but irreversible symptoms may begin to occur. In PKU screening, for example, testing too early (e.g., in the first day of life) could miss an infant with the disease for biological reasons, and testing too late (e.g., in the second or third week of life) could lead to starting treatment too late to avert the severe long-term consequences of the disease.

Another consideration is that when tests for several disorders are performed on the same sample, the optimal times for the different assays may not overlap sufficiently to permit equally reliable results for each test. While testing at 3 to 5 days of life is usually considered optimal for PKU screening, testing for homocystinuria, for example, using the same blood sample would detect only about one-half of infants with homocystinuria; testing at 3 to 4 weeks, rather than in the first week, is considered optimal for detecting homocystinuria.

### Number of Specimens

A single blood specimen collected from infants before discharge from the hospital has generally been considered sufficient in screening for PKU

<sup>6</sup> The vast majority of U.S. infants are born in hospitals (712), and the collection of blood specimens for newborn screening is a routine procedure before infants are discharged. Births that occur outside of hospitals are difficult to monitor, and although birth attendants are instructed to collect a specimen, enforcement is difficult, even if testing is mandatory.

and congenital hypothyroidism.<sup>7</sup> Two recent developments have cast doubt, however, on the adequacy of a single specimen to test for PKU and congenital hypothyroidism. These developments, discussed below, have led some people to advocate the collection of a second blood specimen during the second or third weeks of an infant's life. A second specimen can be collected from an infant either during a well-child visit to a physician or nurse practitioner or during an outpatient visit to a hospital. In Oregon, the collection of a second blood specimen is mandatory at the time of the first well-child visit between 2 and 6 weeks of age (325) and is achieved in about 85 to 90 percent of infants (81).

**PKU Testing.**—One development that casts doubt on the adequacy of a single specimen for newborn screening for PKU testing is the trend toward discharging an increasing percentage of newborns from the hospital before the optimal time for testing for PKU at about 3 to 5 days of age. In 1985, an estimated 41.4 percent of infants born in U.S. hospitals were discharged from the hospital nursery before the third day of life—an increase from 30.9 percent of infants in 1980 (707). The increasing percentage of blood specimens being taken in the first 1 or 2 days of life may increase the probability that tests on infants with PKU will be falsely negative, possibly causing some infants with PKU to escape detection and treatment.<sup>8</sup> Since serum phenylalanine levels in PKU cases rise steadily over the first few days of

life and the difference between phenylalanine levels in normal and PKU infants increases with each day of life, some analysts suggested that up to 16 percent of infants with PKU could be missed for biologic reasons if tests were performed on blood specimens taken before the infant was 24 hours old (282,283,409).

So far, empirical data have not borne out these analysts' predictions (377,423,576). Although the available data are from clinics and institutions that care for children with mental disabilities and may underestimate the number of missed cases of PKU (because once a child is mentally retarded, the underlying cause may not be determined and reported as PKU), in practice, phenylalanine levels in PKU infants are usually higher than in normal infants even on the first day of life, and various technical adjustments can be made to raise the sensitivity of the assays used to identify PKU in first day samples (409,574). Thus, it does not appear likely that the collection of blood samples around 24 hours of age would result in missed cases of classic PKU as a result of low phenylalanine levels in the blood on the first day. Even so, however, an infant with PKU might be missed by the screening system for other reasons (e.g., because the infant was not being screened at all, or because the infant's first blood specimen was lost in transit).

One way of gaining assurance that infants with PKU are not being missed on the first test is to obtain a second blood specimen for retesting all infants. Experience in the Texas and Oregon screening programs, which perform a second screen on a majority of infants, suggests that the probability of missing PKU infants on the first test is low, because no additional cases of PKU have been found via tests on second blood specimens (81,640).

**Congenital Hypothyroidism Testing.**—A development that casts doubt on the adequacy of a single specimen in newborn screening for hypothyroidism is preliminary evidence that an additional 5 to 10 percent of infants with congenital hypothyroidism can be detected by second testing at 3 to 4 weeks of age—these are affected infants with no biochemical signs of congenital hypothyroidism on the first specimen taken during the first week of life (359,376); the severity of the hypothy-

<sup>7</sup>In some instances, second specimens have to be collected because of problems with the first specimen, but such instances are fairly uncommon. Reasons to collect a second specimen include failure of a lab to receive a first specimen, not enough blood present in the first specimen to complete the tests, incomplete demographic information on the specimen card (missing age of the infant when the sample was taken, illegible name, etc.), or a filter paper that contains anything other than the infant's blood.

<sup>8</sup>OTA is unaware of any cases of PKU that have been documented as being missed for this reason, but the theoretical probability that cases of PKU could be missed because of early hospital discharge of newborns is an important issue for newborn screening programs. Screening programs may be legally responsible for detecting all affected infants in the region covered—a fact that provides additional incentive to do as much as possible to identify all affected cases. Although routinely collecting a second specimen on all infants may be one of the most comprehensive approaches to guard against missed cases, this approach is certain to increase costs associated with newborn screening. It would have the advantage, however, of detecting diseases such as homocystinuria, which are not normally detectable in the first screening test.



roidism in the additional infants compared to the infants identified in the first test is still unknown. Several screening programs (e.g., Texas) routinely use a second specimen for hypothyroidism testing.

### **Laboratory Performance: Quality Assurance and Proficiency Testing Programs**

The consequences of failing to identify an abnormal blood specimen, leading to a failure to diagnose and treat, can be catastrophic for infants with diseases such as PKU, congenital hypothyroidism, galactosemia, MSUD, biotinidase deficiency, and congenital adrenal hyperplasia. Furthermore, missed cases of PKU and congenital hypothyroidism have led to lawsuits against the State in which the infant was screened, the attending physician, the hospital of birth, or the Federal Government (in the case of a military birth) (279).<sup>9</sup> The reasons for missed cases are diverse and involve errors in many stages of the process, from specimen collection, to laboratory analysis, to followup and treatment (279).

One step newborn screening laboratories can take to improve the reliability of their laboratory results and to maintain high-quality technical performance is to participate in proficiency testing or broader external quality assurance programs. Proficiency testing provides an opportunity for a laboratory to have an external check on its ability to identify abnormal specimens and recognize normal specimens. Such a check is especially important in low-volume laboratories in testing their laboratory ability to identify particularly rare conditions. By participating in proficiency testing on a regular basis, a laboratory can judge and compare its methods and test kits against others for precision and accuracy. In a broader sense, quality assurance programs, which include proficiency testing, facilitate the identification of laboratories

<sup>9</sup>Thus far, 20 to 25 lawsuits involving missed cases of PKU or congenital hypothyroidism have been brought to trial in the United States. Some of these cases have resulted in financial settlements as high as \$4 million (601). Each of these cases involved brain damage that could have been avoided by treatment if the children had been identified accurately in newborn screening. Settlements in such cases typically cover the cost of caring for a mentally retarded child, the economic value of the child's lost potential earnings throughout his lifetime, and may also include financial compensation for conscious pain and suffering (601).

that are encountering technical problems and, through the combined experience of many participating laboratories, help to improve laboratory performance.

The major effort in external quality assurance for newborn screening programs in the United States has been that undertaken by CDC. To assist States in developing and maintaining high levels of accuracy and precision in their newborn screening programs, CDC operates two services:

1. a quality assurance program designed for newborn screening programs (called the "Standardization Program to Improve Laboratory Screening for Hypothyroidism, Phenylketonuria, and Other Inborn Metabolic Disorders"), and as part of that,
2. a proficiency testing program for newborn screening laboratories.<sup>10</sup>

The quality assurance program, which is jointly funded by CDC and the Health Resources and Services Administration, seeks to promote standards of good laboratory practice. Its objectives are to ensure that newborn screening laboratories accurately identify all cases of metabolic disorders in time to initiate treatment. Laboratory participation in CDC's quality assurance program for newborn screening is voluntary.

One of the central features of the quality assurance program operated by CDC is the production and distribution of quality control materials to laboratories for their internal use in maintaining the accuracy and precision of their screening tests for PKU and congenital hypothyroidism. This service is provided free of charge to State laboratories. Quality control materials are also provided to manufacturers to assist them in standardizing their equipment or testing kits (324).

CDC's proficiency testing service for newborn screening laboratories is one feature of an extensive proficiency testing program operated by CDC pursuant to the Clinical Laboratory Improvement Act of 1967 (Public Law 90-174, 42 U.S.C.). Newborn screening laboratories that qualify under the act's provisions as "interstate laboratories" (e.g.,

<sup>10</sup>CDC discontinued its proficiency testing service for clinical laboratories in general in 1986, but it decided to retain these services for newborn screening for PKU and congenital hypothyroidism testing (592).

the Pacific Northwest and the New England regional programs) are required to participate in the program. Newborn screening laboratories that do not accept specimens across State boundaries may voluntarily participate in the CDC proficiency testing service for newborn screening, but they are not required to do so. Currently, almost all State newborn screening programs use CDC's proficiency testing service.

Although many observers believe that CDC's quality assurance program is an essential component of the process of newborn screening (324), no empirical studies have been done to measure the impact of the program on the effectiveness of

newborn screening in detecting and treating affected infants. According to interim data from a CDC analysis, however, the overall precision of newborn screening as measured by proficiency test results has improved in the past 5 years (64). Thirty-three percent of all PKU proficiency testing results in the first quarter of 1981 were more than 25 percent away from the consensus target value; by the end of 1985, the figure had dropped to 7.6 percent. This decrease in the range of values obtained from the participating laboratories indicates a general improvement in reliability among laboratories using different procedures (592).

## COST= EFFECTIVENESS OF SEVEN NEWBORN SCREENING STRATEGIES

Available studies of the cost-effectiveness of various strategies for newborn screening have compared the cost of laboratory detection of PKU (47,85,471,621,729), congenital hypothyroidism (46,368), or several metabolic disorders together (123,650,727) with the averted costs to society associated with caring for a mentally retarded child. Most of the studies have omitted the costs of specimen collection and long term followup, and few of them applied a discount rate to future costs of treatment or institutional care. None of the studies has considered the costs and effectiveness of collecting a second specimen for additional screening. All of these studies have suggested that newborn screening for PKU, congenital hypothyroidism, and the rarer disorders result in a large cost savings to society in general.

OTA performed a cost-effectiveness analysis of the basic strategy for newborn screening—a one-specimen screening protocol for PKU and congenital hypothyroidism—compared to no screening and of six alternative newborn screening strategies compared to the basic strategy for screening. For the basic strategy, OTA ascertained the net costs or savings to the U.S. health care system and net effectiveness in identifying cases of PKU and congenital hypothyroidism requiring treatment. For the expanded strategies, OTA ascertained the incremental costs associated with detecting addi-

tional cases of selected congenital diseases beyond those detected in the basic strategy.

The seven newborn screening strategies considered in OTA's cost-effectiveness analysis are depicted in figure 5-1. These strategies vary with respect to two key features—the number of specimens tested and the types of congenital disorders tested for—but all of them involve various combinations of tests for two or more of the following five disorders: PKU, congenital hypothyroidism, homocystinuria, galactosemia, and MSUD. The costs and effectiveness of tests for biotinidase deficiency, sickle cell anemia, cystic fibrosis, and congenital adrenal hyperplasia are not included in the cost-effectiveness analysis, although OTA obtained preliminary information on the costs of adding tests for these four conditions to an ongoing screening program.

The basic screening strategy, Strategy I, involves the collection of a single blood specimen to test for PKU and congenital hypothyroidism and is compared in OTA's analysis to no screening at all. Since all 50 States and the District of Columbia offer newborn screening for PKU *and* congenital hypothyroidism, Strategy I (screening for PKU and congenital hypothyroidism using one specimen) reflects the minimum situation common to all U.S. newborn screening programs, and the

**Figure 5-1 .—Newborn Screening Strategies Compared in OTA’s Cost-Effectiveness Analysis**

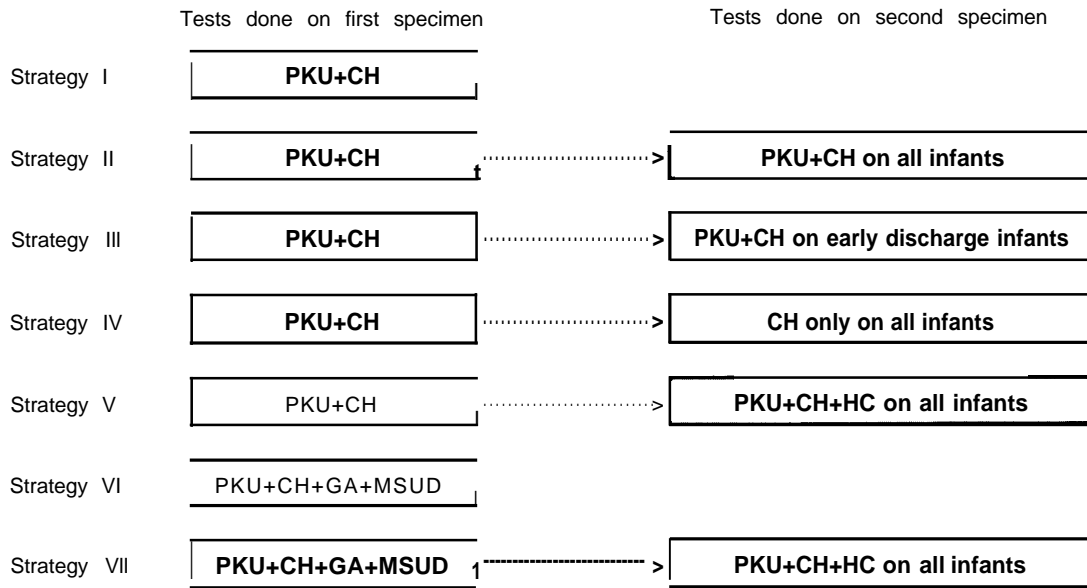

Abbreviations PKU - phenylketonuria; CH - congenital hypothyroidism, GA galactosemia; MSUD - maple syrup urine disease; HC = homocystinuria  
 SOURCE Office of Technology Assessment. 1988

other strategies reflect additional screening options some programs have taken. Accordingly, choices by screening programs are likely to be made not between some expanded screening strategy and no screening at all, but between a one-specimen strategy for PKU and congenital hypothyroidism (Strategy I) and expanded one- or two-test strategies (e. g., Strategies II through VII). Therefore, each of the other six screening strategies is compared to Strategy I rather than to no screening.

Strategies II, III, IV, and V follow an initial blood specimen to test for PKU and congenital hypothyroidism with a second specimen (the disorders tested for in the second specimen vary). Strategy VI uses a single specimen to test for four disorders (PKU, congenital hypothyroidism, galactosemia, and MSUD). Strategy VII, which is the most comprehensive screening strategy of all, uses a first specimen to test for four disorders (PKU, congenital hypothyroidism, galactosemia, and MSUD), then a second specimen to test for three disorders (PKU, congenital hypothyroidism, and homocystinuria).

For the basic strategy, OTA calculated net health care costs or savings to society per 100,000

infants screened. For comparisons of expanded screening strategies with Strategy I, OTA calculated the net incremental cost per extra case detected. All costs in OTA’s analysis were expressed in 1986 dollars. In calculating net health care costs, OTA considered the costs of blood specimen collection, and laboratory detection, and medical treatment as well as costs of foster care, institutional care, and special education that would be averted by early treatment of affected infants. The value of avoiding premature death from the targeted conditions was not quantified in dollar terms. As a measure of effectiveness, OTA used the number of cases of targeted disorders detected and treated per 100,000 infants screened, and for the expanded strategies, the number of extra cases detected by these approaches. In all the analyses, this measure of effectiveness is used as a reasonable, though imperfect, proxy for the number of children whose lives would have been greatly diminished in quality or whose deaths would have occurred in childhood if their disorders had not been detected by newborn screening.

OTA’s cost-effectiveness analysis included both a base case analysis and a sensitivity analysis. The

base case used what OTA deemed to be most likely values for major variables. The sensitivity analysis tested the sensitivity of the results to changes in assumptions about these variables. OTA estimated ranges for the major variables and then grouped together “worst case” and “best case” assumptions in the two parts of the sensitivity analysis.

### Components of OTA’s Cost-Effectiveness Analysis

Basic information on the data used in OTA’s analysis of seven newborn screening strategies is presented below. For more detailed information on the data and methods used in the analysis, see appendix I.

#### Effectiveness Estimates

Estimates of the effectiveness of newborn screening for the five disorders were presented in the previous section. In the base case, OTA used the median incidence estimate and the median of the estimated percentage of affected infants detected shown in table 5-3. As noted earlier, these estimates represent a consensus of experts in the field and are the best estimates available.

#### Cost Estimates

OTA’s estimate of the average costs of collecting a blood specimen from a newborn in the hospital was based on data from a time study at three Wisconsin hospitals (47). OTA estimated the average cost of collecting a first specimen in the hospital to be \$6.07. Unlike first specimens, the majority of second specimens are likely to be collected outside a hospital, possibly during a well-child visit at the physician’s office or clinic. In the absence of data on the costs of specimen collection performed in a physician’s office, OTA assumed in the base case that the cost of collecting a second blood specimen would be equal to the cost of collecting the first.

The resource costs of detecting the five disorders (PKU, congenital hypothyroidism, galactosemia, MSUD, and homocystinuria) through newborn screening were estimated for OTA’s analysis on the basis of data provided by three State newborn screening programs: Washington (609), Wiscon-

sin (259), and Iowa (256). Since single-specimen tests for PKU and congenital hypothyroidism are available in all States, OTA combined costs for PKU and congenital hypothyroidism tests into a single estimate. In the base case analysis, OTA used the mean of the range of the combined cost of detecting these two disorders. The range was from \$3.88 to \$8.16 per specimen, giving a mean cost of \$5.65. The mean of the range of the cost of detecting galactosemia and MSUD was also used in the base case. With a range from \$1.25 to \$1.60 per specimen, the mean detection cost for galactosemia was \$1.43; the range for MSUD was \$0.98 to \$1.84, giving a mean detection cost for MSUD of \$1.41. Only one estimate for homocystinuria testing was available from the data provided by the three State programs, and that figure, \$0.93 per specimen, was used in the base case.

OTA’s estimate of the costs of treatment for PKU and congenital hypothyroidism was derived from a study of PKU by Barden and colleagues (47) and from a study of congenital hypothyroidism by Barden and Kessel (46) and inflated to 1986 values: \$107,712 undiscounted total treatment costs for PKU and \$14,837 undiscounted total treatment costs for congenital hypothyroidism. Barden and colleagues discounted PKU and congenital hypothyroidism treatment costs to present value using a 7- and a 10-percent discount rate: for PKU treatment, \$53,855 at a 7-percent discount rate and \$42,670 at a 10-percent rate; and for congenital hypothyroidism treatment, \$4,260 at a 7-percent discount rate and \$3,588 at a 10-percent rate. The discount rate applied to future costs in OTA’s base case was 7 percent. The sensitivity analysis used both a 7- and a 10-percent discount rate.

Data on treatment costs for galactosemia, MSUD, and homocystinuria comparable to data on treatment costs for PKU and congenital hypothyroidism are not available in the literature. Children with galactosemia need no special supplemental diet—just avoidance of foods containing galactose. In OTA’s analysis, the costs of treatment for galactosemia were assumed to be close to the costs of treatment for congenital hypothyroidism mentioned above (46), because both these disorders include minor costs for medication and long-term costs of clinical care and monitoring. Treatment

costs for MSUD and homocystinuria in OTA's analysis were assumed to be approximated by the costs of long-term PKU treatment (47), which includes costs for a special diet and also long-term clinical care and monitoring.

In estimating the *health care costs averted* by newborn screening and treatment for PKU, OTA's analysis focused on the averted costs of custodial care and institutionalization and the averted costs of special education. OTA's estimate of the average net costs of residential care and special education for PKU was derived from Barden and colleagues (47) and inflated to 1986 values (see app. I for more details).

In estimating the health care costs averted by screening and treatment of congenital hypothyroidism, OTA focused similarly on averted costs of custodial care and institutionalization associated with mental retardation in individuals with untreated congenital hypothyroidism, with data derived from Barden and colleagues (46). In OTA's analysis, the averted costs of custodial care and institutionalization for individuals with untreated congenital hypothyroidism were combined with the averted costs of special education for untreated individuals and discounted to present value.

The health care costs averted by screening and treatment of galactosemia, MSUD, or homocystinuria are more difficult to quantify than those averted by screening and treatment of PKU and congenital hypothyroidism. No data are currently available to estimate the cost of the progressive deterioration and almost certain death that occur in the majority of cases of galactosemia or MSUD, or the long-term disabilities and risk of premature death that occur in cases of homocystinuria. Consequently, although OTA's analysis does quantify the costs of screening and treatment for these three conditions, it does not quantify the costs averted by screening and treatment for these conditions.

## Findings of the Base Case Analysis

OTA's base case analysis indicates that, in comparison to no screening, Strategy I results in a net *savings* to the U.S. health care system of over \$3.2 million per 100,000 infants screened. This strategy results in the detection of 34.6 cases of PKU

and congenital hypothyroidism per 100,000 infants screened. For each of the cases identified and treated, net health care savings to society are approximately \$93,000 (see table 5-4). The net health care savings associated with Strategy I in comparison to no screening result from the detection and treatment of infants with PKU or congenital hypothyroidism who would have required custodial care or special education had their disorders not been treated.

OTA's base case analysis shows that each of the expanded strategies for screening are both more effective in detecting affected infants and more costly than Strategy I.<sup>11</sup> The number of additional cases of congenital disorders detected and the incremental costs incurred (i. e., the reductions in societal health care savings achieved by Strategy I) by six expanded newborn screening strategies in comparison to Strategy I are shown in table 5-5.

Strategy II (a first specimen to test for PKU and congenital hypothyroidism and then a second specimen to test for PKU and congenital hypothyroidism on all infants) detects 36.6 affected cases per 100,000 infants screened—or 2 cases more than Strategy I. The net incremental health care cost (i. e., loss of savings) per extra case detected and treated via this approach compared to Strategy I is very high—about \$466,000.

Strategy III (a first specimen to test for PKU and congenital hypothyroidism and then a second specimen to test for these disorders only in infants discharged early from the hospital whose blood specimens were collected before 3 days of age—41 percent of infants in 1985) results in the detection of 1.3 more affected cases per 100,000 infants screened than Strategy I. The net incremental cost per extra case detected and treated via this approach compared to Strategy I is approximately \$253,000.

Strategy IV (a two-specimen strategy that involves a first specimen to test for PKU and congenital hypothyroidism and a second specimen to

<sup>11</sup>It should be noted, however, that each of the expanded screening strategies would result in a net savings to the health care system if they were compared to no screening at all, but in each case the net savings would be lower than that obtained for the basic strategy.

**Table 5-4.—Effectiveness and Health Care Savings of Newborn Screening Strategy I Compared to No Screening (1986 dollars)**

	Number of cases detected per 100,000 infants screened	Net health care savings per 100,000 infants screened	Net health care savings per case detected and treated
Strategy (1st test for PKU and CH only) v. No screening	34.6	\$3,218,000	\$93,000

Abbreviations: PKU = phenylketonuria; CH = congenital hypothyroidism  
SOURCE Office of Technology Assessment 1988

**Table 5-5.—Incremental Effectiveness and Health Care Costs of Newborn Screening Strategies Compared to Strategy I (1986 dollars)**

Strategies compared	Number of extra cases detected per 100,000 infants screened	Net incremental costs per extra case detected and treated
Strategy II (1st test for PKU and CH followed by 2nd test for PKU and CH on all infants) v. Strategy I . . . . .	2.0	\$466,000
Strategy III (1st test for PKU and CH followed by 2nd test for PKU and CH on early discharge infants only) v. Strategy I . . . . .	1.3	\$253,000
Strategy IV (1st test for PKU and CH followed by 2nd test for CH only on all infants) v. Strategy I . . . . .	1.7	\$432,000
Strategy V (1st test for PKU and CH followed by 2nd test for PKU, CH, and HC on all infants) v. Strategy I . . . . .	2.5	\$421,000
Strategy VI (1st test for PKU, CH, GA, and MSUD) v. Strategy I . . . . .	18	\$173,000
Strategy VII (1st test for PKU, CH, GA, and MSUD followed by 2nd test for PKU, CH, and HC) v. Strategy I . . . . .	4.3	\$317,000

Abbreviations: PKU = phenylketonuria; CH = congenital hypothyroidism; HC = homocystinuria; GA = galactosemia; MSUD = maple syrup urine disease.  
SOURCE Office of Technology Assessment, 1988

test for congenital hypothyroidism only) results in the detection of 36.3 affected cases, or 1.7 extra cases over Strategy I. The incremental cost of each case detected and treated via this approach compared to Strategy I is quite high—about **\$432,000**.

Strategy V, another two-specimen strategy, follows a first specimen for PKU and congenital hypothyroidism with a second specimen for these two disorders plus homocystinuria. Homocystinuria is the one condition of the five disorders considered in this analysis that is not optimally detected during the first week of life, so if a second specimen is being collected for PKU and congenital hypothyroidism, it might be advantageous to test for homocystinuria on the second round. Strategy V detects **2.5 cases** more per **100,000** infants screened than Strategy I.

The net incremental cost of detecting and treating an extra case via Strategy V relative to Strategy I is fairly high—approximately **\$421,000**. It is important to note, however, that in calculat-

ing the incremental costs associated with Strategy V, OTA did not include the costs averted by detecting and treating infants afflicted with homocystinuria (due to lack of available data); the inclusion of data on these averted costs, were such data available, would probably reduce the incremental costs associated with this strategy.

Strategy VI (a single-specimen strategy that adds tests for galactosemia and MSUD to the first specimen used to test for PKU and congenital hypothyroidism) detects 1.8 more cases per 100,000 infants screened than Strategy I. The net incremental health care cost per extra case found and treated by Strategy VI compared to Strategy I is low compared to the other strategies—about **\$173,000**. *The net* incremental cost associated with detecting additional cases via Strategy VI, in fact, is lower than the incremental costs associated with detecting additional cases via Strategies II, III, IV, or V—an observation that suggests that detecting extra cases by adding tests to an initial specimen for PKU and congenital hypothyroidism is less costly than detecting extra cases via a second

specimen. The cost of collecting additional specimens adds significantly to the incremental costs of the two-specimen strategies OTA considered.

Strategy VII involves all of the newborn screening tests considered in this analysis: a first specimen to test for PKU, congenital hypothyroidism, galactosemia, and MSUD, and a second specimen to test all infants for PKU, congenital hypothyroidism, and homocystinuria. Strategy VII detects almost 39 affected infants per 100,000 screened, or 4.3 more cases than Strategy I. The net incremental cost of detecting and treating an extra case via Strategy VII is rather high—approximately **\$317,000**.

### Components and Findings of the Sensitivity Analysis

To test the sensitivity of the results of OTA's base case analysis of newborn screening strategies to changes in estimates of major variables—i.e., specimen collection costs, laboratory testing costs, percentage of affected cases detected, and discount rates—OTA examined the application of possible ranges of estimates for these variables in a sensitivity analysis. The estimates that were most favorable to the overall cost-effectiveness of newborn screening were combined in a “best” case analysis, and the least favorable estimates were combined into a “worst” case analysis. OTA performed best case and worst case analyses only for the four screening strategies with the most differences among them: Strategies I, II, VI, and VII.

#### Components of the Sensitivity Analysis

To vary the effectiveness of newborn screening, OTA varied the estimated percentage of affected infants detected by newborn screening (which reflects ranges in reported incidence as well as practical limitations on detection). The lowest of the range of estimated percentage rates for particular disorders were used in the worst case; the highest of the range of estimated percentage rates were used in the best case (see table 5-3).

To vary the costs of specimen collection in the sensitivity analysis, OTA used one approach to vary costs for the two one-specimen screening

strategies (Strategies I and VI) and a different approach to vary them for the two two-specimen strategies (Strategies II and VII). For the one-specimen strategies (I and VI), the cost of specimen collection used in the base case was varied by 50 percent: 50-percent higher (worst case) and 50-percent lower (best case). For the two-specimen strategies (II and VII), the cost of the first specimen collection was retained from the base case analysis, but the cost of the second specimen collection was varied: in the worst case, the cost of second specimen collection was assumed to be the same as collecting the first specimen; in the best case, it was assumed to be 25-percent lower.

To vary screening and treatment costs and discount rates, OTA used the same approach for all four strategies being compared:

- *Newborn screening and treatment costs:* The lowest estimate derived from data provided by one of the three State newborn screening programs was used in the best case; the highest estimate of the three was used in the worst case (see app. I).
- *Discount rate applied to future costs:* A 7-percent discount rate was applied to future costs in the best case; a 10-percent discount rate was used in the worst case.<sup>12</sup>

Together, all these changes in assumptions alter the expected number of cases detected per 100,000 infants screened and the costs of detection, treatment, and untreated disease. For an example of the calculation OTA used to arrive at an estimate of the overall costs or savings achieved by screening, see appendix I.

#### Findings of the Sensitivity Analysis

In the base case analysis, the net savings to the health care system associated with Strategy I (a single specimen for PKU and congenital hypothyroidism) compared to no screening was about \$3.2 million per 100,000 infants screened. As shown in table 5-6, net savings from Strategy I compared to no screening remain positive over the entire

<sup>12</sup>In general, costs that occur in the future are reduced more when a higher discount rate is used. Since averted costs of untreated disease are much greater than costs of preventive treatment, the use of a higher discount rate is appropriate for the worst case analysis since it lowers the averted costs.

range of assumptions tested, though they are as high as \$4.5 million per 100,000 infants screened in the best case and as low as \$626,000 per 100,000 infants screened in the worst case. Whereas 34.6 cases were detected per 100,000 infants screened by Strategy I in the base case, 41.3 cases are detected in the best case and only 28.8 are detected in the worst case.

Table 5-7 shows the incremental cost per extra case detected by Strategies II, VI, and VII, each compared to Strategy I. For Strategy VI (a single test strategy for PKU, congenital hypothyroidism, galactosemia, and MSUD), the sensitivity analysis shows that the incremental cost per each extra case detected by Strategy VI varies from \$277,000 in the worst case and \$85,000 in the best case, compared to \$173,000 in the base case analysis.

Strategies II and VII are both two-specimen testing strategies. For Strategy II (a first test for PKU and congenital hypothyroidism followed by a second test for PKU and congenital hypothyroidism on all infants), the incremental costs per extra case detected compared to Strategy I are about \$620,000 in the worst case and \$453,000 in the best case (see table 5-7), compared to \$466,000 in the base case analysis.

In Strategy VII (a first test for PKU, congenital hypothyroidism, galactosemia, and MSUD, followed by a second test for PKU, congenital hypothyroidism, and homocystinuria), the sensitivity analysis shows incremental costs per extra case found by Strategy VII compared to Strategy I are about \$474,000 in the worst case and \$218,000 in the best case, whereas the base case analysis estimated incremental costs of \$317,000 per extra case detected and treated.

The results of the sensitivity analysis represent extremes in the range of possible results, and it is unlikely that all the worst factors (or best factors) would occur together in a single situation. The sensitivity analysis shows, however, that the incremental costs of detecting additional infants with congenital disease are still somewhat high even under the most favorable situations, and can become substantially higher under the worst situations. It is worth noting, however, that under the best case assumptions, the cost of Strategy VI,

the cost of detecting an extra case in an expanded one-specimen strategy to test for two additional disorders, is low relative to the costs of many therapies currently considered standard medical procedure. The \$85,000 needed to detect an extra case of galactosemia or MSUD in Strategy VI (and with the best case assumptions) would buy an entire lifetime for a child with one of these disorders, compared to, for example, expenditures (in 1986 dollars) of about \$28,000 (162) to \$40,000 (98) per life-year gained from heart transplantation for congestive heart failure, or \$36,500 (530) per life-year gained from hemodialysis for end-stage renal disease.

## Conclusions

In OTA's calculations, the costs of specimen collection and screening are important components of cost. By reducing the numbers of laboratories and avoiding duplication of fixed costs and highly trained personnel, costs of laboratory testing would probably be reduced. It follows that centralization of laboratories could make a substantial difference in the overall cost-effectiveness of newborn screening. Of the three State programs that provided data, the highest unit screening cost used in OTA's analysis was derived from the State program that had the lowest specimen volume, despite total overall costs similar to those of the other programs that provided data.

OTA's base case analysis compared the costs of screening by various expanded strategies with the consequences of doing less screening. This analysis showed that collecting additional specimens from a large portion of infants, whether to detect some percentage of extra cases of PKU, congenital hypothyroidism, or homocystinuria, or as a precautionary measure to guard against missed cases, is undoubtedly a costly strategy.

Only about one-half of all States screen for homocystinuria and MSUD, and about one-third screen for galactosemia, even though screening tests and treatment for these conditions have been available for many years. The rarity of these conditions is probably the main reason for their comparative unpopularity among screening programs. That rarity translates into high net costs of detecting each additional case, as reflected in OTA's



**Table 5-6.—Sensitivity Analysis: Net Health Care Savings and Number of Cases Detected by Strategy I Compared to No Screening (1986 dollars)**

Strategy	Sensitivity analysis					
	Base case		Worst case		Best case	
	Net health care savings per 100,000 Infants screened	Number of cases detected per 100,000 Infants screened	Net health care savings per 100,000 infants screened	Number of cases detected per 100,000 Infants screened	Net health care savings per 100,000 infants screened	Number of cases detected per 100,000 infants screened
Strategy I (1st test for PKU and CH only) v No screening	\$3,218,000	346	\$626,000	288	\$4,562,000	413

Abbreviations PKU = phenylketonuria CH = congenital hypothyroidism

SOURCE Office of Technology Assessment 1988

**Table 5-7.—Sensitivity Analysis: Incremental Effectiveness and Health Care Costs of Newborn Screening Strategies Compared to Strategy 1 (1986 dollars)**

Strategies compared	Sensitivity analysis					
	Base case		Worst case		Best case	
	Number of extra cases detected per 100,000 Infants screened	Net Incremental cost per extra case detected & treated	Number of extra cases detected per 100,000 infants screened	Net Incremental cost per extra case detected & treated	Number of extra cases detected per 100,000 infants screened	Net Incremental cost per extra case detected & treated
Strategy II (1st test for PKU and CH followed by 2d test for PKU and CH on all Infants) v Strategy I	20	\$466,000	16	\$620,000	20	\$453,000
Strategy VI (1st test for PKU, CH, GA, and MSUD) v Strategy I	18	\$173,000	13	\$277,000	29	\$85,000
Strategy VII (1st test for PKU, CH, GA, and MSUD followed by 2d test for PKU, CH and HC) v Strategy I	4.3	\$317,000	31	\$474,000	57	\$218,000

Abbreviations PKU = phenylketonuria CH = congenital hypothyroidism HC = homocystinuria GA = galactosemia MSUD = maple syrup urine disease

SOURCE Office of Technology Assessment 1988

analysis. Whether it is worth \$100,000 or more to detect an additional case of one of the treatable congenital disorders is, of course, a question that can only be answered in the context of larger societal decisions.

OTA's analysis incorporates the strategies that have been in use for many years in newborn

screening programs. Estimated net costs might be quite different, however, if new tests for additional disorders were considered. Combinations of tests other than the ones considered in OTA's analysis could change both the net costs and savings resulting from newborn screening and the incremental costs of detecting extra cases of congenital disease.

## **COSTS OF LABORATORY TESTING FOR FOUR ADDITIONAL DISORDERS**

Four additional disorders not examined in OTA's cost-effectiveness analysis—biotinidase deficiency, sickle cell anemia, cystic fibrosis, and congenital adrenal hyperplasia—are being considered for inclusion in an increasing number of newborn screening programs. Screening for sickle cell anemia, in particular, is gaining widespread support as a result of recent evidence linking early detection and treatment of the disease with reduced mortality among infants with the disease in the first few years of life.

Few evaluations of the sensitivity and specificity of the screening tests and of the long-term value of early detection and treatment of biotinidase deficiency, congenital adrenal hyperplasia, sickle cell anemia, and cystic fibrosis have been conducted, so data on the long-term effectiveness of screening for these four disorders are unavailable. In the absence of more data on effectiveness, estimates of the cost of screening and treatment, not to mention costs averted by screening, would be incomplete at best. For that reason, OTA did not evaluate tests for these disorders in its cost-effectiveness analysis of newborn screening strategies. Since many newborn screening programs are incorporating these tests, however, preliminary cost estimates of detection are presented in this chapter. Cost estimates presented below are limited by the lack of sources of data; since only a few programs are screening for the disorders, and fewer have available cost information, the data below may not reflect representative additional costs of detecting these disorders.

OTA asked four State screening programs (Maryland, Iowa, Washington, and Colorado) to

identify and value the resources needed to test for the four additional disorders using the same blood specimens collected for PKU and congenital hypothyroidism (216,252,255,609). On the assumption that the tests for the four disorders would be added to the specimens for PKU and congenital hypothyroidism, the costs reported show no costs of additional specimen collection. Despite efforts to standardize the estimates, there may be somewhat more variability among programs in the methods used to derive costs of testing for the four disorders discussed below than to derive costs of testing for PKU, congenital hypothyroidism, galactosemia, homocystinuria, and MSUD.

### **Biotinidase Deficiency**

Data from Maryland's newborn screening program suggest that testing for biotinidase deficiency adds about \$0.11 to the unit costs of laboratory testing for PKU and congenital hypothyroidism (216). With an approximate incidence rate for this deficiency of 1 in 45,000 live births, screening for biotinidase deficiency would yield approximately 2 to 3 infants with the disease per 100,000 screened.

Infants with biotinidase deficiency cannot recycle the B vitamin biotin, and treatment involves the oral administration of biotin. Experience to date suggests that such treatment saves severely affected infants from sudden death and prevents various kinds of neurologic damage in infants with milder cases. How many infants with milder cases could have been treated as effectively on the basis of a later clinical diagnosis without screening is not known.

## Sickle Cell Anemia

Data from Iowa's newborn screening program suggest that screening for sickle cell anemia would add about \$3.51 per infant screened to the cost of PKU and congenital hypothyroidism screening (255).<sup>3</sup> In the general population, approximately 32 cases of sickle cell anemia would be expected in 100,000 infants screened (the incidence among black newborns is about 1 in 500; 1984 census data indicate that approximately 16 percent of the total number of live births in the United States are black) (712).<sup>4</sup>

Many of the infants with sickle cell anemia are at risk for overwhelming infection and sudden death in the first year or two of life. Newborn screening, followed by the use of prophylactic antibiotics, may allow for a significant reduction of this risk (198). Implications for later treatment of infants diagnosed by newborn screening are unknown.

## Cystic Fibrosis

Screening for cystic fibrosis would yield approximately 40 affected infants per 100,000 infants

<sup>3</sup>This estimate may be high because of the size of and cost allocation methods employed by the Iowa program.

<sup>4</sup>As noted earlier, the incidence of sickle cell anemia is higher among blacks and in people of Mediterranean and Middle Eastern descent. Screening for the disease in high-risk populations with a higher incidence of the disease will obviously yield different costs and effectiveness results than those yielded by screening in the general population.

screened at an estimated additional cost of \$1.32 per specimen screened, according to data from the Rocky Mountain States Regional Program (252). The most immediate potential benefit to presymptomatic diagnosis of cystic fibrosis may be the treatment of nutritional deficiencies which place some affected infants at high risk for neonatal death and impair the growth and development of other infants with cystic fibrosis.

Screening for cystic fibrosis is currently being performed on a pilot basis in a few States. It is unknown whether early diagnosis and treatment for cystic fibrosis improves long-term outcomes.

## Congenital Adrenal Hyperplasia

It would cost an additional \$1.50 per infant screened to include testing for congenital adrenal hyperplasia in an ongoing screening program, according to data derived from the Washington State program (609). Screening for congenital adrenal hyperplasia would detect approximately 4 infants with the disease in 100,000 infants screened. Approximately half of the afflicted infants would have been at high risk for sudden death due to salt-wasting crises. Screening and early treatment can prevent such neonatal deaths. Infants with congenital adrenal hyperplasia who are not at risk for salt-wasting can benefit from accurate early diagnosis and treatment by receiving hormone therapy, possibly averting abnormal gender orientation and reproductive problems later in life.

## FINANCING AND REIMBURSEMENT FOR NEWBORN SCREENING AND TREATMENT

State newborn screening and treatment programs are funded by a combination of Federal, State, and private sources. Since the passage of the Omnibus Budget Reconciliation Act of 1981 (OBRA-81), (Public Law 97-35) establishing the Maternal and Child Health (MCH) block grant under Title V of the Social Security Act, Federal funds for newborn screening have been included in the MCH block grants.<sup>5</sup> For every \$0.75 of

<sup>5</sup>For more information on the MCH block grant program, see chs. 3 and 6.

State funds spent on maternal and child health services, \$1.00 of Federal funds is contributed. The total authorization for the MCH block grants was set at \$373 million under OBRA-81. MCH block grant funds were appropriated in two parts: 85 percent to be transferred directly to the States, and 15 percent to be set aside for special projects (in a Federal program entitled "Special Projects of Regional and National Significance"). Funding for certain genetic services was specified under the special projects portion of the budget, but the

States could also use the general block grant funds to support their newborn screening programs (182),

The Deficit Reduction Act of 1984 (Public Law 98-369) raised the authorization for MCH block grants to \$478 million. For fiscal year 1987, the Omnibus Reconciliation Act of 1986 (OBRA-86), (Public Law 99-509) increased the authorization for the MCH block grant to \$553 million. That act designated a percentage of the additional funds authorized for the MCH block grants (\$75 million in fiscal year 1987) to be used for newborn screening for "sickle cell anemia and other genetic disorders." The percentage was set at 7 percent in fiscal year 1987 (or \$5.25 million), 8 percent in fiscal year 1988, and 9 percent in fiscal year 1989. If these funds for screening are appropriated as outlined, newborn screening, particularly for sickle cell anemia, could be expanded in many State screening programs under the Division of Maternal and Child Health's general oversight provisions.

An increasing number of State newborn screening programs are charging user fees for the tests they perform. Currently, 12 States specify in their enabling legislation that a charge may be levied, and others specify the exact amount that may be charged (32). Reported charges, which are not necessarily related to actual costs, range from about \$3 to \$24<sup>16</sup> per infant screened in State and private laboratories (32,562,592).

The costs to a family of newborn screening services are usually reimbursable under private insurance plans as well as various public programs, depending on the individual plan operating in the State. Under Medicaid, reimbursement for newborn screening is generally included in reimbursement for overall perinatal care. Newborn screening programs or hospitals may have to absorb the cost of screening if the family is unable to pay or if funds cannot be collected from the third party.

In contrast to the relatively small, one-time fee for the screening test (if one is charged at all), the costs of treatment are incurred over a long period of time in each case. Treatment for PKU, for example, consists of an essential dietary product that is initiated in the first weeks of the child's life and continues to be used through adolescence and, in some cases, indefinitely. Total cost of the special PKU formula over the first 20 years of a patient's life has been estimated at \$58,270 (47), or about \$3,000 per year. Similar dietary regimens are used to treat individuals with homocystinuria and MSUD.

Such dietary treatment is not normally reimbursed as medication or medical treatment, so standard health insurance may not cover the costs. Various sources of third-party payment aside from standard health insurance are available in general, but the availability of these sources varies widely among States and even within States. Some families may have access to programs that provide the diet for all patients regardless of ability to pay. In the long run, most families probably rely on a combination of different sources and may bear the entire cost of the diet during periods in which no reimbursement is available. Some families may discontinue the diet. In young children, however, going off the diet is highly likely to cause mental retardation. In older children, even brief gaps in maintenance of the diet therapy may diminish performance and alter the child's demeanor (12). For women with PKU, there is an additional problem. If women with PKU have gone off the diet before or during their childbearing years, it may be more difficult to ensure that they resume it before conception, especially if they are not aware of the significant risks to their fetus if they are not on the diet.

A survey of sources of reimbursement for the PKU diet showed that the State health agency was the sole or major source of third-party funds for PKU treatment in 54 out of 98 newborn screening programs surveyed, but that a variety of other sources were also used, each contributing a minor portion of the reimbursement: the Crippled Children's Program; Medicaid; the Women, Infants, and Children (WIC) program; military sources; private health insurance; the patient's family; the treatment clinic; and the formula manufacturer

<sup>16</sup>The State with the \$24 charge also includes the cost of followup and initiation of treatment in this charge (345).



*Photo credit: Association for Retarded Citizens of the United States*

Kammy and Sheila McGrath, poster children for 1961-62, are sisters who were born with PKU. Sheila is severely retarded. Mental retardation was avoided in Kammy, her younger sister, because newborn screening detected her disorder and allowed the prompt initiation of a special preventive diet.

## CONCLUSIONS

Since newborn screening is organized at the State level, there are in practice about as many different strategies for screening as there are programs. OTA's analysis examined the net health care costs and effectiveness of the basic strategy common to all newborn screening programs and then calculated the incremental costs and effectiveness of six expanded strategies for screening compared to that basic strategy. The basic strategy—screening all infants using one specimen for PKU and congenital hypothyroidism—resulted in net health care savings of about \$3.2 million per

(570). In some cases, the WIC program covers the cost of the diet for PKU women during their pregnancy, but not before or after pregnancy. PKU formula is covered under Medicaid in some States (e.g., California, Colorado, and Washington), and is variably classified as a medical supply, a special medical item, a drug, or as a component of enteral or parenteral nutrition programs. In Wisconsin (where Medicaid does not cover the PKU formula), a \$3 "surcharge" is added to newborn screening charges for all infants to cover the cost of the formula and diet for those who need them, which places the cost on users of the program (i.e., the childbearing population) rather than general taxpayers (Wise, Assembly Bill 550, Act 157, 1983).

In some of the smaller States, or in some States without coordinated screening programs, the individual physician caring for the PKU child sometimes can become a key figure in obtaining reimbursement for the PKU diet. Moreover, differences in medical opinion about the number of years that a patient should remain on the diet can lead to different levels of advocacy on the part of physicians in securing long-term and consistent funding for the diet. In some cases, then, access to these sources of funding may be determined largely by the degree to which the individual physician or screening director becomes involved in the process.

100,000 infants screened and in the identification and treatment of about 34 infants with PKU and congenital hypothyroidism per 100,000 infants screened. These figures represent a net savings of about \$93,000 per case detected and treated. Under the best case and worst assumptions used in OTA's sensitivity analysis, the net savings per case detected and treated would amount to at best, \$110,000, and at worst, \$22,000.

While most State screening programs probably started with PKU testing and later added congen-

ital hypothyroidism testing, many programs have gradually expanded their activities over the last 10 years to include collection of second specimens or testing for galactosemia, homocystinuria, and/or MSUD. Each of the strategies involving a single-specimen with additional tests or involving two specimens detects more cases of congenital disorders than does the single specimen with tests for PKU and congenital hypothyroidism alone. In choosing among the various expanded strategies for detecting extra cases of congenital disorders, however, newborn screening programs have to take into account the incremental costs that are incurred through these approaches. OTA's analysis found that the incremental costs of any of the two-specimen strategies compared to the basic one-specimen strategy were quite high, ranging from \$253,000 to \$466,000 per extra case found and treated. The least costly strategy for detecting extra cases beyond those found in a single specimen to test for PKU and congenital hypothyroidism involved the addition of extra tests (i.e., for galactosemia and MSUD) onto the first specimen.

Overall, the data presented in OTA's analysis suggest that the basic newborn screening strategy—i.e., screening for PKU and congenital hypothyroidism in a single specimen—is less costly than no screening at all and that the six expanded screening strategies OTA considered in its analysis incur substantial additional costs. Since all State screening programs have at least adopted the basic strategy for newborn screening, the potential net savings nationwide have been large: testing for PKU and congenital hypothyroidism using a single specimen from each infant results in net savings to the U.S. health care sector of about \$120 million per year assuming that 3.7 million infants are screened in a given year. Many States have expanded screening beyond this basic strategy, however, and since these expanded strategies are costly, the actual savings to the health care sector are somewhat diminished.

Regardless of the strategy chosen for a particular newborn screening program, aspects of the organization and delivery of the services can have a major impact on the costs and effectiveness of screening. Foremost among them is laboratory costs, which are directly influenced by the effi-

ciency of the testing procedures. It is plausible that centralization of laboratory facilities for all States or multi-State regions could reduce the duplication of fixed costs, such as capital equipment, and could make better use of highly trained personnel. In addition, decentralized laboratories are less likely to encounter abnormal test results—a significant disadvantage in developing the expertise necessary to correctly identify cases of very rare diseases. At present, some States do not have centralized laboratories, although the trend in recent years has been toward the consolidation of facilities for newborn screening into one laboratory per State. For some States with small populations, however, even one centralized laboratory may not be the best use of resources and expertise; such States should be encouraged to form regional laboratories with neighboring States, while maintaining their own followup and treatment facilities on a local level.

Critical to the effectiveness of newborn screening are such tasks as ensuring the completeness of screening and the followup of positive screening tests. The accomplishment of both tasks is probably more difficult and less reliable in a screening program that lacks a tightly coordinated system of screening, followup, and treatment services. Data on the frequency and types of errors that can occur are emerging in a few programs. It would be particularly useful, however, to collect and compare data on the completeness and accuracy of screening across all the States' programs on an ongoing basis.

Newborn screening is currently expanding in scope to include tests for diseases such as sickle cell anemia, congenital adrenal hyperplasia, cystic fibrosis, and biotinidase deficiency, and tests for these conditions are rapidly being incorporated into routine screening practices. These diseases have little in common, except that in some cases, they can be life-threatening before appropriate medical care can be obtained. In these cases, newborn screening can provide essential early warning and treatment. In other cases, the benefit of earlier diagnosis and access to specialized treatment may be a demonstrable improvement in prognosis and course of the disease. At present, such tests appear promising, but reliable information to determine the overall value of newborn

screening for these four conditions compared to the effectiveness of their diagnosis and treatment through standard medical channels is still lacking. As data do become available, it would be useful to compare the incremental effectiveness and costs of incorporating these tests into various newborn screening strategies, such as the ones considered in this chapter.

For the established screening tests, the OTA analysis has shown that more screening, while leading to additional cases detected, can be quite costly, although some of this cost can be reduced

by modifying the screening protocols (e.g., performing the additional tests on the first specimen, without obtaining a second specimen from each infant). State screening programs should proceed cautiously with screening for biotinidase deficiency, sickle cell anemia, cystic fibrosis, and congenital adrenal hyperplasia. Concurrently, the Federal Government might put as a priority the collection and evaluation of data that would allow careful analysis in future of costs as well as effectiveness of widespread screening for these disorders.

---

Chapter 6

# Well-Child Care



# CONTENTS

	<i>Page</i>
<b>Introduction</b> . . . . .	<b>119</b>
Recommendations Regarding the Frequency and Content of Well-Child Care . . . . .	120
Frequency and Timing of Periodic Well-Child Care Visits . . . . .	120
Immunization. . . . .	122
Screening Tests.. . . . .	124
Anticipatory Guidance . . . . .	124
Effectiveness of Well-Child Care. . . . .	126
Effectiveness of Well-Child Care as a Whole. . . . .	126
Effectiveness of Five Specific Components of Well-Child Care. . . . .	130
Cost-Effectiveness of Childhood Immunization . . . + . . . . .	133
Literature Review. . . . .	133
Impact of Vaccine Costs on Estimates of Net Cost Savings . . . . .	134
Conclusions About the Cost-Effectiveness of Childhood Immunization ... ..	135
Financing and Availability of Well-Child Care Services . . . . .	136
Private insurance Coverage of Well-Child Care Services . . . . .	136
Medicaid Coverage of Well-Child Care for Eligible Poor Children . . . . .	136
Public Direct Subsidies for Well-Child Care . . . . .	137
Access to Well-Child Care: Children's Immunization Status . . . . .	140
Conclusions . . . . .	144

## Tables

<i>Table No.</i>	<i>Page</i>
6-1. <b>Recommendations Regarding the Number of Well-Child Care Visits</b> . . . . .	<b>121</b>
6-2* <b>Recommendations Regarding Schedules for Active Immunization of Normal Infants and Children</b> . . . . .	<b>123</b>
6-3. <b>Recommendations Regarding Physical and Developmental Evaluations for Well-Child Care</b> . . . . .	<b>125</b>
6-4. <b>Recommendations Regarding the Performance of Specified Screening Tests in Well-Child Care</b> . . . . .	<b>126</b>
6-5. <b>Impact of Vaccine Prices on the Cost-Effectiveness of Pertussis Vaccine</b> ... ..	<b>135</b>
6-6. <b>Percentage of School-Entry-Aged U.S. Children Immunized, 1980/81 to 1985/86.</b> . . . . .	<b>142</b>
6-7. <b>Percentage of 2-Year-Old U.S. Children Immunized, 1979 and 1985</b> . . . . .	<b>142</b>
6-8. <b>Percentage of 1-to 4-Year-Olds and 5- to 6-Year-Olds Immunized by Race, 1985.</b> . . . . .	<b>143</b>
6-9. <b>Percentage of 1-to 4-Year-Olds and 5- to 6-Year-Olds Immunized by Place of Residence, 1985</b> . . . . .	<b>143</b>

## INTRODUCTION

“Well-child care” encompasses a variety of preventive health services offered by physicians or other health professionals at defined points in a child’s life (227). Beginning as early as the second or third week after birth and extending into adulthood, well-child care services include physical examinations and other tests that screen for illness or developmental problems, immunizations against polio and other diseases, health education, and parental guidance.

The most obvious objective of well-child care is to prevent morbidity<sup>2</sup> or premature death by immunizing a child or identifying an illness early enough to intervene with effective therapy. Other goals that have been proposed for well-child care include support and reassurance for families of young children and the provision of a “medical home” in the event that illness develops (103).

The extent to which these intermediate objectives ultimately affect children’s health status is difficult to trace. Nevertheless, it is widely believed that a continuous relationship between the patient and a single source of medical care has beneficial effects (103,179), including greater patient satisfaction, improved adherence to medical regimens, and more effective and less costly acute care when it is needed (103,179 ).<sup>3</sup>

The provision of well-child care and other medical services (e. g., acute and ill child care) at the same site potentially enhances a child’s continuity of care. Conversely, access to a continuous

source of medical care may increase the likelihood that a child will get the full complement of well-child care (10,67,68). Thus, it is difficult to untangle the effects of well-child care from the effects of improved continuity of care.

Well-child care services can be, and often are, delivered in settings that are completely separate from physician practices. School-based screening programs and immunization clinics are examples of such settings. The effectiveness of specific procedures may vary with the setting and system of care in which they are provided. For example, screening in schools may be less effective than screening in physicians’ practices if the schools’ linkages with necessary followup medical care are weak. On the other hand, not all physicians may use the most effective screening techniques. The evidence on the effectiveness of well-child care should be interpreted in light of these potential differences by setting. In any case, delivery of well-child care in settings that are unconnected with the delivery of other primary care services does not promote continuity of care and whatever health benefits or satisfaction it confers.

This chapter summarizes a variety of professional recommendations on the content of well-child care from birth through 11 years of age. It also reviews the evidence on the effectiveness of well-child care as a whole and of five specific components of well-child care. The five components were selected to illustrate the kinds of evidence available on the effectiveness of commonly recommended procedures and are not a comprehensive list of well-child care components. The chapter also examines evidence on the cost-effectiveness of childhood immunizations. Most other aspects of well-child care have not been scrutinized for cost-effectiveness because of the difficulty of establishing their effectiveness. Finally, the chapter addresses issues in the financing and delivery of these services to young children and their implications for children’s access to effective well-child care.

<sup>1</sup> Parts of this chapter are based on a paper prepared under contract to OTA by Charles Homer, entitled “Evaluation of the Evidence on the Effectiveness of Well-Child Care for Children” (284).

<sup>2</sup> In recent years, morbidity has increasingly come to include not only physical illness but also any deviation from a child’s full physical, cognitive, emotional, and social health potential (247).

<sup>3</sup> Evidence to support this contention is equivocal. Patient satisfaction and adherence to prescribed medical regimens appear to increase with greater continuity of care, whereas a significant effect of continuity on health outcomes and costs has not been demonstrated. For a comprehensive review of the literature on continuity of care, see S.S. Flint, “The Impact of Continuity of Care on the Utilization and Cost of Pediatric Care in a Medicaid Population” (170).



Photo credit: Scottish Rite Children's Hospital

A well-child care visit includes a review of the child's medical history, a physical assessment, a developmental and behavioral assessment, immunization when necessary, and anticipatory guidance.

## RECOMMENDATIONS REGARDING THE FREQUENCY AND CONTENT OF WELL-CHILD CARE

A typical well-child care visit to a health care provider takes approximately 10 to 12 minutes (521). The American Academy of Pediatrics (AAP) recommends that a well-child care visit include the following components:

1. an initial or interval medical history,
2. a physical assessment,
3. a developmental and behavioral assessment, and
4. anticipatory guidance (17).

At some well-child care visits, immunizations are administered. Following the visit with the health care provider, a number of specific screening measures may be undertaken. These include such things as vision screening and tuberculosis testing.

Several professional bodies in the United States and selected other Western nations have made recommendations regarding the frequency and content of well-child care and immunizations. Their recommendations are reviewed below.

### Frequency and Timing of Periodic Well-Child Care Visits

Recommendations concerning the frequency and timing of well-child visits vary substantially among Western nations, among States within the United States, and even over time within any particular recommending organization. The specific recommendations of a variety of groups—AAP, the Canadian Task Force on the Periodic Health Examination, the Canadian Pediatric Society, and three British groups concerned with well-child care—are outlined in table 6-1.4

In general, the various guidelines demonstrate the following characteristics:

<sup>4</sup>The British Pediatric Association Working Group is in the process of formulating its recommendations. Those presented here are based on the judgment of the chairman and vice-chairman of that group. These are their personal views and not those of the British Pediatric Association Working Group.

Table 6-1.— Recommendations Regarding the Number of Well-Child Care Visits (for children 1 month to 11 years of age)

	Number of well-child visits recommended by age of child			
	1-6 months	7-12 months	1-4 years	5-11 years
<b>United States:</b>				
AA?, 1977 <sup>a</sup> .....	4	1	4	3
AAP, 1981 <sup>b</sup> .....	4	2	5	4
AAP, 1985 <sup>c</sup> .....	4	2	5	4
<b>Canada:</b>				
Task Force on the Periodic Health Examination, 1979 <sup>d</sup> .....	4	2	3	2
Canadian Pediatric Society, 1983 <sup>e</sup> .....	4	2	4	4
<b>Great Britain:</b>				
Court Committee, 1976 <sup>f</sup> .....	1	1	3	Not included
Royal College of General Practitioners/British Medical Association, 1984 <sup>g</sup> .....	1	1	2	Not included
Chair and Vice Chair of Working Party on Developmental Surveillance in Childhood, 1987 <sup>h</sup> .....	1	1	2 †	Not included

<sup>a</sup>Committee on Standards of Child Health Care, American Academy of Pediatrics, *Standards of Child Health Care*, 3rd ed. (Evanston, IL 1977)

<sup>b</sup>Committee on Practice and Ambulatory Medicine, American Academy of Pediatrics, "Guidelines for Health Supervision of Children and Youth," Information sheet, Elk Grove Village, IL, 1981

<sup>c</sup>American Academy of Pediatrics, *Guidelines for Health Supervision* (Elk Grove Village, IL:1985).

<sup>d</sup>Task Force on the Periodic Health Examination, Health Services and Health Promotion Branch, Canadian Department of National Health and Welfare, *The Periodic Health Examination, 1979* (Ottawa, ON Canadian Department of National Health and Welfare, 1979)

<sup>e</sup>Canadian Paediatric Society, *Child Health Care Guidelines* (Ottawa, ON: March 1983).

<sup>f</sup>British Committee on Child Health Services (S D M Court, Chair), *Fit for the Future* (London, England Her Majesty's Stationery Office, 1976)

<sup>g</sup>Royal College of General Practitioners and the General Medical Services Committee of the British Medical Association, *Handbook of Preventive Care for Pre-school Children* (London, England, Royal College of General Practitioners, 1984)

<sup>h</sup>D Hall, Chair, and A Macfarlane, Vice Chair, British Paediatric Association Working Party on Developmental Surveillance in Childhood, personal communication, London/Oxford, England, February 1987 (These are the personal opinions of Drs. Hall and Macfarlane and do not reflect the final position of the working party)

† Full physical evaluation recommended at age 3/2, home assessment by nurse of walking and language use at 2 also recommended; screening tests for hearing and vision recommended before school entrance, with physical examination only if not performed at earlier time

SOURCE Office of Technology Assessment, 1988

- more visits recommended in the United States than in Great Britain (although most likely fewer visits in the United States than are commonly provided in other Western European nations);
- recommendations for a more focused physical examination than in the past;
- increased concern with identifying behavioral and developmental problems, coupled recently, especially in Great Britain, with increased recognition of the difficulties in reliably and validly identifying such problems; and
- a lack of consensus, especially apparent among the States, concerning the appropriate populations for screening procedures, the optimal age for the administration of such procedures, and the frequency of their use.

Several caveats should be kept in mind when making comparisons between recommended American and British schedules. Infants and children in the United Kingdom do not routinely receive immunizations from their physician; the British schedules, therefore, do not include immuniza-

tion visits. In England, from the time of the creation of the National Health Service until the mid-1970s, preventive child care services were provided separately from other medical services. Since the mid-1970s, however, there has been more emphasis on the provision of well-child care and other medical care in a common setting (e.g., a general practitioner's office).

In comparing recommendations within the North American continent, one must consider the dramatically differing perspectives of the recommending bodies. In the United States, for example, the expenses of Medicaid's Early and Periodic Screening, Diagnosis, and Treatment (EPSDT) program are partly borne by the States. Thus, EPSDT recommendations for frequency of visits and mandated screening reflect not simply medical judgment but political and economic judgments of what each State is willing to spend for child health services for the poor.<sup>5</sup> In recent years, the number of EPSDT screening visits recommended for children from 1 month to 11 years of age has

<sup>5</sup>See p. 136 for a description of Medicaid's EPSDT program.

ranged from 7 visits in Alaska to as many as 18 visits in Indiana and West Virginia (284).

Whereas State EPSDT administrators may have a tendency to restrict services, AAP is likely to be expansive. Though primarily seeking to advance the health of children, AAP also represents the professional needs of its pediatrician members. AAP has relied on expert judgment to formulate its recommendations. It admits that its recommended schedule is rather arbitrary in nature but contends that the recommendations constitute a minimum desirable standard for normal children. Nevertheless, AAP's recommendations have stirred controversy even within the pediatric community (275).

The Canadian Task Force on the Periodic Health Examination represents an entirely different perspective on the provision of preventive care. This body, which included representatives from a variety of disciplines, was charged with making recommendations for periodic health examination by the Deputy Ministers of Health of Canada. The only recommended child health interventions for children beyond the neonatal period that the task force considered to have good evidence to support inclusion in well-child care visits were immunizations and dental examinations. Other recommended interventions, including anticipatory guidance and developmental evaluation, were considered to be backed by poor evidence in support of their inclusion in a periodic health examination, although they might be recommended on other grounds (89).

The recommendations of the Canadian Pediatric Society were strongly influenced by the AAP recommendations (402); they were also influenced by the recommendations of the Canadian Task Force on the Periodic Health Examination.

The existence of wide variations in recommended well-child services, although understandable in light of the differing health care systems and varied organizational perspectives, nonetheless reflects the lack of good evidence supporting any one program of care over another.

## Immunization

Immunization is perhaps the most fundamental component of well-child care. AAP and other

groups recommend that children in the United States be routinely vaccinated against eight diseases:

- polio,
- diphtheria,
- tetanus,
- pertussis (whooping cough),
- measles,
- mumps,
- rubella (German measles), and
- *Haemophilus influenzae b* (Hib).

Polio vaccinations are administered by an oral vaccine that is commonly referred to as "OPV" (oral polio vaccine). Diphtheria, tetanus, and pertussis vaccinations are usually administered in one shot known as "DTP," and measles, mumps, and rubella vaccinations are similarly administered in a shot known as "MMR." The new Hib vaccine is a polysaccharide vaccine for the prevention of Hib infection, the leading cause of bacterial meningitis. It has been licensed since April 1985 (109). A varicella (chickenpox) vaccine maybe licensed for use within the next year (287).

Table 6-2 charts the schedules for active immunization of normal infants and children recommended by various U. S., Canadian, and British sources. Immunization schedules are recommended in the United States by the three groups:

- the Immunization Practices Advisory Committee (ACIP) of the U.S. Public Health Service (690);
- the Committee on Infectious Diseases of AAP (17); and
- the Commission on Public Health and Scientific Affairs of the American Academy of Family Physicians (14).<sup>6</sup>

Until September 1986, when ACIP announced a slight change in its schedule (discussed below), all three U.S. groups recommended identical childhood immunization schedules. The schedule recommended by the Canadian National Advisory Committee on Immunization was identical to that of the United States prior to 1986, but the

<sup>6</sup>A fourth U.S. body, the U.S. Preventive Services Task Force recently published its recommendations for immunization, but did not recommend specific schedules. It found that "there is good evidence to support recommendation" of childhood immunizations for poliomyelitis, DTP, MMR, and Hib (358).

Table 6-2.—Recommendations Regarding Schedules for Active Immunization of Normal Infants and Children

	Recommended schedule by type of vaccine			
	MMR	OPV	DTP	Hib
<b>United States:</b>				
ACIP, 1986 <sup>a</sup>	15 months	4 doses— 2, 4, and 15 months, and 4-6 years	5 doses— 2, 4, 6, and 15 months, and 4-6 years	24 months
AAP, 1985 <sup>b</sup>	15 months	4 doses— 2, 4, and 18 months, and 4-6 years	5 doses— 2, 4, 6, and 18 months, and 4-6 years	24 months
AAFP, 1987 <sup>c</sup>	15 months	4 doses— 2, 4, and 15 or 18 months, and 4-6 years	5 doses— 2, 4, 6, and 15 or 18 months, and 4-6 years	24 months
<b>Canada:</b>				
Task Force on the Periodic Health Examination, 1979 <sup>d</sup>	12-15 months	5 doses— 2, 4, 6, and 18 months, and 5-6 years	5 doses— 2, 4, 6, and 18 months, and 5-6 years	
National Advisory Committee on Immunization, 1984 <sup>e</sup>	12 months	5 doses— 2, 4, 6, and 18 months, and 4-6 years	5 doses— 2, 4, 6, and 18 months, and 4-6 years	24 months <sup>f</sup>
<b>Great Britain:</b>				
Joint Committee on Vaccination and Immunisation, 1984 <sup>g</sup>	Measles—at 1-2 years Rubella—all girls at 10-14 years	4 doses— 3, 4½ to 5, 8½ to 11 months, and at school entry	4 doses— 3, 4½ to 5, 8½ to 11 months, and at school entry	—

Abbreviations ACIP = Immunization Practices Advisory Committee; MMR = measles, mumps, and rubella live virus vaccine, OPV = oral poliovirus live vaccine, DTP = diphtheria, tetanus, and pertussis vaccine, Hib = *Haemophilus influenzae b* polysaccharide vaccine; AAP = American Academy of Pediatrics, AAFP = American Academy of Family Physicians

<sup>a</sup>Centers for Disease Control, Public Health Service, U.S. Department of Health and Human Services, "New Recommended Schedule for Active Immunization of Normal Infants and Children," *Morbidity and Mortality Weekly Report* 35(37):577-579, Sept 19, 1986.

<sup>b</sup>American Academy of Pediatrics, *Guidelines for Health Supervision* (Elk Grove, IL: 1985).

<sup>c</sup>American Academy of Family Physicians, *Recommended Immunization Schedule for Children* brochure, revised January 1987.

<sup>d</sup>Task Force on the Periodic Health Examination, Health Services and Promotion Branch, Canadian Department of National Health and Welfare, *The Periodic Health Examination, 1979* (Ottawa, ON: Canadian Department of Health and Welfare, 1979).

<sup>e</sup>National Advisory Commission on Immunization, *A Guide to Immunization for Canadians* (Ottawa, ON: Ministry of Supply and Services, 1984).

<sup>f</sup>This dose may be omitted if live (oral) polio vaccine is being used.

<sup>g</sup>Added to recommendations on Mar 1, 1988, *Canadian Diseases Weekly Report*, "National Advisory Committee on Immunization (NACI) Statement on *Haemophilus b* Polysaccharide Vaccine," *Canadian Diseases Weekly Report* 12(9):33-35, 1988.

<sup>h</sup>Joint Committee on Vaccination and Immunisation for the Secretary of State for Social Services, the Secretary of State for Scotland and the Secretary of State for Wales, Welsh Office, Scottish Home and Health Department, British Department of Health and Social Services, *Immunisation Against Infectious Disease* (London, England) Crown Copyright, 1984).

SOURCE Office of Technology Assessment, 1988

British schedule differed (e.g., the British did not recommend vaccination against mumps).

In September of 1986, ACIP announced a new recommended schedule calling for the simultaneous administration of MMR, DTP, and OPV to all children at 15 months of age, rather than the administration of MMR at 15 months and DTP and OPV at 18 months (690). ACIP cited three potential benefits from the revised childhood immunization schedule:

1. a decrease in the number of health-care provider visits required for immunization during the second year of life,
2. an accompanying decrease in costs, and

3. an increase in the percentage of children who are fully or partially immunized by 24 months of age (690).

After ACIP revised its schedule, the American Academy of Family Physicians revised its recommended schedule to allow the administration of DTP and OPV at 15 or 18 months of age (289). AAP did not change its recommended schedule, but it will be noting that MMR, DTP, and OPV can be administered simultaneously at 15 months (19).

The Hib polysaccharide vaccine was added to the list of childhood vaccines recommended by ACIP and AAP in 1985 (111). ACIP and AAP

groups recommend Hib immunization of all children at 24 months of age and immunization of older children up to 5 years of age who have not already received the Hib vaccine at 24 months. On the basis of clinical trials, ACIP has recommended Hib immunization of children in known high-risk groups (e.g., immunocompromised children, children who attend day care) at 18 months of age (684). AAP has not formally recommended use of the vaccine in high-risk groups of 18 to 23 months of age (109).

As of February 1987, over 8 million doses of the Hib polysaccharide vaccine had been distributed in the United States (108). The availability and use of this vaccine is an important initial step toward eliminating Hib infections. Each year Hib accounts for an estimated 12,000 cases of bacterial meningitis, primarily in children under 5 years of age, and also accounts for 6,000 other invasive Hib infections, such as pneumonia and epiglottitis (99). A 5-percent Hib mortality rate results in approximately 900 deaths each year to children under 5 years of age (684).

Because three-fourths of all Hib cases occur in children under 24 months of age, the current Hib polysaccharide vaccine is only an interim measure until a new Hib vaccine that is fully effective for children under 24 months of age can be developed and licensed (684). A Hib polysaccharide-protein-conjugate vaccine, currently under development, may meet this need. Clinical studies in infants have demonstrated that the conjugate vaccine appears to be safe and more effective than the current Hib vaccine (109,161).

## Screening Tests

Specific screening tests are often performed at well-child visits.<sup>7</sup> Table 6-3 summarizes the physical and developmental evaluations recommended

<sup>7</sup>For a discussion of newborn screening, see ch.5 and app. H.

by AAP and other professional groups for children 1 month to 11 years of age. A physical examination involves a series of diagnostic tests intended to detect a variety of medical conditions. Some specific physical diagnostic procedures are the Ortolani maneuver for identification of congenital dysplasia of the hip, forward bending for detection of scoliosis, patch testing for discovery of strabismus, and abdominal palpation for detection of tumors. The developmental screening tool most widely used and recommended for use by child health personnel is the Denver Developmental Screening Test (DDST) or one of its adaptations—the DDST-S or the Parents' Developmental Questionnaire (96,184).

Table 6-4 lists the schedules recommended by U. S., Canadian, and British groups for specific hearing, vision, blood count, tuberculosis, and urinalysis screening tests recommended in well-child care.

## Anticipatory Guidance

In the context of well-child care, anticipatory guidance is the provision of education, information, or counseling in order to influence a parent's or child's behavior and thus favorably influence the child's health. It includes everything from traditional medical guidance (e.g., admonitions to avoid contact with children with certain communicable diseases) and nutritional advice to suggestions for appropriate management of the child at specific developmental ages and information about behaviors (e.g., smoking and alcohol use) that adversely affect health.

Medical practitioners traditionally do not spend much time in providing anticipatory guidance. One study found that pediatricians spent 8.4 percent of the time of a well-child visit (only 50 to 60 seconds) providing anticipatory guidance; furthermore, the percentage diminished with increasing patient age (521).

**Table 6-3.—Recommendations Regarding Physical and Developmental Evaluations for Well-Child Care (for children 1 month to 11 years of age)**

	Physical evaluation	Developmental evaluation
<b>United States:</b>		
AAP, 1981 <sup>a</sup>	"At each visit, a complete physical examination is essential"	"By history and appropriate physical examination. If suspicious, by specific objective developmental testing . . ."
AAP, 1985 <sup>b</sup>	Specific evaluations recommended at each age. No mention of exam at 9, 12, and 15 month visits other than growth measurements	Detailed developmental and behavioral guidelines provided at each age, with note of specific items for concern.
<b>Canada:</b>		
Task Force on the Periodic Health Examination, 1979 <sup>c</sup>	Specific physical exam measures recommended for most visits. Complete exams not recommended	PDQ or DDST recommended most visits before age 2½; review history of behavior problems ages 2½, 4, 5, 10; assess parent-child interaction 18 months to 21/2 years
Canadian Pediatric Society, 1983 <sup>d</sup>	Complete physical exam recommended at each visit. Specific items emphasized at particular times	Behavioral history each exam. Language screening 7 times. School performance evaluation yearly beginning age 5.
<b>Great Britain:</b>		
Court Committee, 1976 <sup>e</sup>	Full examination at 6 weeks and pre-school; focused exams at other times	Review development at age 7 months, 18 months, 2½ and 4½ years
Royal College of General Practitioners/British Medical Association, 1984 <sup>f</sup>	Complete physical exam at first visit; brief exam thereafter. Specific points at each visit	Milestone-oriented developmental exam included in each visit
Chair and Vice Chair of Working Party on Developmental Surveillance in Childhood, 1987 <sup>g</sup>	Complete exam at 6 weeks, 8 months, and 3½ years. Focused measures at other times	Brief developmental assessment at 8 months. Home visit at 2 years with brief gross motor and verbal developmental evaluation. "Grave doubts about the value of the neurodevelopmental exam . . ."

Abbreviations: AAP = American Academy of Pediatrics; PDQ = Parents' Developmental Questionnaire; DDST = Denver Developmental Screening Test

<sup>a</sup>Committee on Practice and Ambulatory Medicine, American Academy of Pediatrics, "Guidelines for Health Supervision of Children and Youth," information sheet, Elk Grove Village, IL, 1981

<sup>b</sup>American Academy of Pediatrics, *Guidelines for Health Supervision* (Elk Grove Village, IL 1985)

<sup>c</sup>Task Force on the Periodic Health Examination, Health Services and Promotion Branch, Canadian Department of National Health and Welfare, *The Periodic Health Examination, 1979* (Ottawa, ON: Canadian Department of National Health and Welfare, 1979).

<sup>d</sup>Canadian Pediatric Society *Child Health Care Guidelines* (Ottawa, ON: March 1984)

<sup>e</sup>British Committee on Child Health Services (S. D. M. Court, Chair), *Fit for the Future* (London, England: Her Majesty's Stationery Office, 1976)

<sup>f</sup>Royal College of General Practitioners and the General Medical Services Committee of the British Medical Association, *Handbook of Preventive Care for Pre-school Children* (London, England: Royal College of General Practitioners, 1984)

<sup>g</sup>D. Hall, Chair, A. Macfarlane, Vice Chair, British Paediatric Association Working Party on Development Surveillance in Childhood, personal communication, London/Oxford, England, February 1987. (These are the personal opinions of Drs Hall and Macfarlane and do not reflect the final position of the working party)

SOURCE Office of Technology Assessment, 1988



**Table 6-4.— Recommendations Regarding the Performance of Specified Screening Tests in Well-Child Care (for children 1 month to 11 years of age)**

	Hearing screening	Vision screening	Blood count (Hgb/Hct)	Tuberculosis testing	Urinalysis
<b>United States:</b>					
<b>AAP, 1981<sup>a</sup></b>	4, 5 years <sup>b</sup>	3-6, 8 years <sup>c</sup>	Once each infancy, preschool, school	12 months, then 1-2 years	Once each infancy, preschool, school
AA F, 1985 <sup>d</sup>	5 years <sup>b</sup>	3, 6, 8 years <sup>c</sup>	Optional 9 months	High risk 9, 15 months, 3-5 years	5, 7, 9 years
<b>Canada:</b>					
Task Force on the Periodic Health Examination, 1979 <sup>e</sup>	2½, 5, 10 years <sup>f</sup>	2-5 years	Low SES 9 months	High risk 5 years BCG age 5	Not recommended
Canadian Pediatric Society, 1983 <sup>g</sup>	4, 5 months <sup>h</sup> 3, 5 years	6 months 3-6 years	High risk 9 months 5 years	High risk 9 months	Not recommended
<b>Great Britain:</b>					
Court Committee, 1976 <sup>i</sup>	7 months 4½ years	7 months 2½, 4½ years	Not mentioned	Not mentioned	Not mentioned
Royal College of General Practitioners/British Medical Association, 1984 <sup>j</sup>	7 months 2½ years 4½ years	7 months 2½ years 4½ years	Not mentioned	"BCG when appropriate"	Not mentioned
Chair and Vice Chair of Working Party on Developmental Surveillance in Childhood, 1987 <sup>k</sup>	8 months 4½ years	4½ years	Not mentioned	Not mentioned	Not mentioned

Abbreviations: AAP = American Academy of Pediatrics; SES = socioeconomic status; BCG = Bacillus Calmette-Guérin vaccine for tuberculosis, Hgb/Hct = hemoglobin/hematocrit.

<sup>a</sup>American Academy of Pediatrics, Committee on Practice and Ambulatory Medicine, "Guidelines for Health Supervision of Children and Youth," information sheet, Elk Grove Village, IL, 1981.

<sup>b</sup>Subjective hearing assessment at all visits and hearing evaluation suggested with speech delay.

<sup>c</sup>Subjective assessment at all visits.

<sup>d</sup>American Academy of Pediatrics, *Guidelines for Health Supervision* (Elk Grove Village, IL: 1985).

<sup>e</sup>Task Force on the Periodic Health Examination, Health Services and Promotion Branch, Canadian Department of National Health and Welfare, *The Periodic Health Examination, 1979* (Ottawa, ON: Canadian Department of National Health and Welfare, 1979).

<sup>f</sup>"Clinical exam for hearing"—not clearly specified.

<sup>g</sup>Canadian Pediatric Society, *Child Health Care Guidelines* (Ottawa, ON: March, 1983).

<sup>h</sup>Method not specified.

<sup>i</sup>Great Britain, Committee on Child Health Services (S. D.M. Court, chair), *Fit for the Future* (London, England: Her Majesty's Stationery Office, 1976).

<sup>j</sup>Royal College of General Practitioners and the General Medical Services Committee of the British Medical Association, *Handbook of Preventive Care for Pre-school Children* (London, England: Royal College of General Practitioners, 1984).

<sup>k</sup>D. Hall, Chair, and A. Macfarlane, Vice Chair, British Pediatric Association Working Party on Developmental Surveillance in Childhood, London/Oxford, England, personal communication, February 1987. (These are the personal opinions of Drs. Hall and Macfarlane and do not reflect the final position of the working party.)

SOURCE: Office of Technology Assessment, 1988.

## EFFECTIVENESS OF WELL-CHILD CARE

The effectiveness of well-child care can be considered in two ways. One way is to consider the effectiveness of well-child care as a whole. The other is to consider the effectiveness of specific components of well-child care.

### Effectiveness of Well-Child Care as a Whole

The literature on the effectiveness of well-child care has been reviewed repeatedly over the past 30 years (95,103,353,379,549,578,770). Although the body of literature on which the reviews have been based has changed little, available reviews have drawn dramatically different conclusions,

ranging from profound doubts about the effectiveness of well-child care to ringing endorsements. This difference in conclusions probably reflects the political context of each review more than the considered body of knowledge.

Although the appropriate goal for well-child care is improvement in a child's health status, positing such a goal presents a substantial risk of failure in judging the effectiveness of such care. The health status of children in particular (and the population in general) is far more strongly determined by social and economic factors than by the nature of medical care (60,66,549); hence, the contribution that well-child care can make to

health outcomes is likely to be modest, and studies to detect these modest contributions must be based on very large samples. Few available studies of the effectiveness of well-child care have had very large samples.

Studies that provide insight into the effectiveness of well-child care as a whole fall into five categories:

1. studies of the effect of varying schedules for the frequency of well-child care visits,
2. studies of the effect of comprehensive care programs that offered well-child care and other health services to poor children in the 1960s and early 1970s,
3. evaluations of Medicaid's well-child care program—the EPSDT program,
4. comparisons of children's health outcomes in different types of health service delivery or insurance programs, and
5. evaluations of services specifically aimed at improving behavioral/developmental outcomes among children.

Studies in each of these categories are discussed in more detail below. None of them directly address the question of the overall effectiveness of well-child care.

The literature evaluating the effectiveness of well-child care as a whole is summarized in the first five tables in appendix J. Overall, a review of available studies suggests three general conclusions. First, there is no evidence to support the contention that well-child care as now performed has an overall effect on childhood mortality or morbidity. On the other hand, one would not expect much evidence because the sample sizes used in these studies have all been inadequate to identify even a 50-percent change in the frequency of mortality. Moreover, the measures of morbidity in most, if not all studies, have been poorly suited to the pediatric population.

Second, some evidence supports the contention that participation in comprehensive child health care, which includes, but is not limited to, well-child care services, can reduce the frequency of hospitalization for acute medical illnesses (336). The inferences that can be drawn from this observation, however, are limited. From a cost perspec-

tive, the decreased frequency of acute hospitalization may be balanced by an increase in surgical admissions for “corrective” procedures.

Third, few studies have adequately considered the effect of well-child care on developmental/social functioning outcomes, but the evidence that exists suggests that well-child care as performed exerts little influence on these outcomes (97,102, 121,232). Some studies with substantial limitations in generalizability or internal validity<sup>8</sup> imply that modifications in the practice of well-child care may have a positive effect on some measures of social functioning.

### **Studies of the Effect of Varying the Frequency of Well-Child Care Visits**

The impact of reducing the frequency of recommended well-child care visits for low-risk children has been specifically considered in two studies (204,274). Neither study found any ill health effects associated with a decrease in the frequency of scheduled well-child visits.

There is a major difficulty in interpreting both of these studies, however—namely, additional unscheduled well-child visits by the children randomized to the lower number of scheduled visits. In one study, infants scheduled for fewer visits were seen three additional times by the office nurses for immunizations and the parents were given informal advice and consultation (274). In the other study, families randomized to the lower frequency group made an average of 1.25 unscheduled well-child visits in the first 2 years of life; at the same time, families randomized to the higher frequency group averaged almost three fewer visits than scheduled. Thus, the average number of well-child visits in the first 2 years of life was 6.19 for the lower frequency group and 7.89 for the higher frequency group—a smaller difference than anticipated in the study design (204).

### **Studies of the Effect of Comprehensive Care Programs in the 1960s and 1970s**

A dramatic expansion in health services for the poor found concrete expression during the 1960s

<sup>8</sup>Internal validity is a measure of the extent to which study results reflect the true relationship of a risk factor (e. g., treatment or technology) to the outcome of interest in study subjects (660).

in the creation of a variety of “comprehensive care” programs for low-income children. The precise character of comprehensive care programs varied, but in most instances, they consisted of personal health services provided by a pediatrician in concert with a social worker and nurse and often included availability of after-hours consultation and continuity of provider over time. Some programs included augmented outreach activities, such as home visiting and case management.

Evaluating comprehensive care programs, which provide diagnosis and treatment of acute and chronic illness, is not the same as evaluating well-child care. Several evaluations of comprehensive care programs did find, however, that children’s use of well-child care services increased with participation in comprehensive care programs; therefore, evaluations of the effectiveness of comprehensive care programs have some bearing on the overall issue of the effectiveness of well-child care.

The net result of the studies of comprehensive care programs is ambiguous. Some studies found improvement in school attendance (315), hospitalization rates (336), incidence of rheumatic fever (214), and greater parental satisfaction with care (10). Other studies, however, found conflicting results, showing that comprehensive care programs had no effect on school attendance (432), utilization of health services (540), or immunization, or health status (10,69,215).

#### Evaluations of Medicaid’s EPSDT Program

Medicaid’s EPSDT is a federally funded, State-administered program that mandates screening of Medicaid-eligible infants and children for any illnesses, abnormalities, or treatable conditions and referral for definitive treatment (544). Because most State EPSDT programs follow guidelines similar to the AAP’s 1981 Guidelines *for Health Supervision* (though with fewer scheduled visits) (20), one would expect that evaluations of the effectiveness of EPSDT in improving the health of poor children would reflect on the effectiveness of well-child care generally.

Unfortunately, the outcome measure used in the two available evaluations of EPSDT—the number of “abnormalities” detected in a screening or the number of “referrals” made (i. e., the number of abnormalities which are deemed to merit a refer-

ral for treatment)—is difficult to interpret. Both evaluations reported a decline in the detection of abnormalities with a child’s time in the EPSDT program (298,321), although in one study (298), the decline became apparent only after adjusting for a general trend toward increased case finding. Because no specific information is provided about the precise nature or remediability of these “abnormalities,” the importance of a reduction in abnormalities/referrals is difficult to interpret. “Thus, the evidence regarding the effectiveness of well-child care that these two studies of the EPSDT program can contribute is limited at best.

#### Comparisons of Child Health Outcomes in Different Health Service Delivery Systems and Insurance Programs

Different systems of care—e.g., solo or group practices, fee-for-service systems, or prepaid health maintenance organization (HMO) type programs—offer different levels of well-child care. If health outcomes are improved in systems that provide more well-child care, one could infer, at least within limits, that well-child care is effective. Two major studies have sought to evaluate the effectiveness of well-child care by examining health outcomes of children in different health delivery systems (329,726).

The first study was undertaken by Kessner and colleagues in the early 1970s in Washington, DC (329). The health outcome measures used in this study—intended to reflect short-term outcomes that both had intrinsic health significance and were amenable to medical intervention—were iron-deficiency anemia, visual disorders, middle-ear infection (acute and chronic), and hearing loss. The investigators found that, after adjustments were made for social class differences in who used different types of providers, there were no differences in any measure of “health status.”<sup>10</sup>

<sup>9</sup>Additional caveats in interpreting the effectiveness of EPSDT are brought to light by Reis’s review of unpublished Division of Maternal and Child Health evaluation projects (520). These projects demonstrate great variability in the proportion of the eligible population that is actually screened and in the proportion of those screened who are identified as having a problem.

<sup>10</sup>A reanalysis of the Kessner data found that users of both prepaid programs and outpatient department clinics had slightly better health status measures than users of solo practitioners (144). The differences were small, however, and may have been due more to the characteristics of the practitioners themselves than to the effectiveness of well-child care.

Investigators in the second major study, a Rand study, randomly assigned children to one of several health insurance plans that offered varying percentages of cost-sharing or free care (726).<sup>1</sup> Health outcome measures used in the Rand study included measures of physiologic health (anemia, hay fever, middle-ear fluid, hearing loss, and visual acuity); limitations in daily activities; mental health perceptions; and general health perceptions. Among children in the different insurance plans, the investigators found no statistically significant differences for any health outcome. The only potentially clinically significant difference they noted between children in the free care and children in the cost-sharing group was the prevalence of anemia among poor children who were anemic at the start of the study.

The relevance of the Rand report's findings to the evaluation of well-child care depends, as does that of Kessner's findings, on whether the different groups of children received different amounts of well-child care. The partial results of the utilization data for children that have been presented (370) suggest that children in cost-sharing plans did use fewer well-child services than children in free care.

The Rand study has been extensively critiqued (244,611) because of the substantial attrition (40 percent) of the initial study group and the small sample size. Critics argue that the health outcome measures used in the Rand study (with the exception of anemia) may not be responsive to medical therapy and that the study did not consider social functioning outcomes. Furthermore, although differences in health outcomes between the poor children in free care versus poor children in cost-sharing plans were not statistically significant, the poor children in cost-sharing plans "were in worse health at the end of the experiment than those in the free plan on six of the eight health measures" (611).

Considering both the original reports and the critiques together, one can reasonably conclude that cost-sharing reduces utilization of both preventive and illness-related services and that this reduction is unlikely to affect adversely the physical/physiologic health of low-risk populations.

<sup>1</sup>The Rand study is described further in ch. 2.

The data are consistent with the hypothesis that cost-sharing adversely affects some measures of health status among the poor, although this is far from definitive. The specific effect of reducing the use of health services on developmental/social functioning remains unexamined.

#### Studies of the Effect of Well-Child Care on Child Behavioral/Developmental Outcomes

The studies that have examined the global effectiveness of well-child care have not considered behavioral and developmental outcomes to any significant extent. However, one study did specifically examine how different styles of well-child care as practiced in clinical settings influence behavioral and developmental outcomes; also, a variety of studies have examined how special types of well-child care might affect such outcomes.

One study compared the influence of pediatricians using different degrees of teaching effort in their well-child care on a variety of maternal and child behavioral and developmental outcomes (102). This study found a strong correlation between teaching effort and maternal knowledge and a small but significant correlation between teaching effort and the mother's self-reported level of positive interaction with her child. On the other hand, the study found that increased teaching was correlated with increased reported behavior problems among children; it found no correlation between teaching effort and formally measured developmental test results. This study is limited by a small sample primarily drawn from middle-class children, but on the whole, its methodological limitations probably minimized the reported effects of the teaching efforts.

The other studies examining the effect of well-child care on developmental and behavioral outcomes are more appropriately considered efficacy studies. In the most methodologically sophisticated of these studies, the intervention consisted of targeted counseling during well-child visits (97). This study found that after 6 months, the group that received counseling ranked higher on scales of maternal-infant interaction than the group that did not receive counseling. No differences in Bayley developmental test scores were noted.

Two other studies of augmented behavior counseling also found small effects (121,232). One found fewer fears in the intervention group than in the control group, little difference in developmental test results, and significant worsening in the intervention group in their responses to the “early school personality questionnaire” (121). The other found differences in early IQ tests that increased up to age 3 and decreased thereafter (although sample attrition may have biased these findings) (232). A variety of measures of self-confidence also showed improved results in the experimental group. However, the extensive nature of the intervention in the latter study—far broader than current ideas of the content of well-child care—makes it incorrect to generalize to the effectiveness of well-child care.

### **Conclusions About the Effectiveness of Well-Child Care as a Whole**

The literature evaluating the effectiveness of well-child care is perhaps more remarkable for its limitations than for its findings. No evidence supports the contention that well-child care (other than immunization) significantly influences mortality or morbidity among children or that it enhances the development of a child’s social competence. On the other hand, sample sizes have been uniformly too small and followup too brief to identify mortality changes; the available measures of childhood morbidity have been inadequate and most investigators have not even looked at developmental outcomes. The particular importance of the outcome measures examined to date and their duration of impact have not been evaluated. For these reasons, expert opinion and good intentions rather than scientific data must be used to guide the provision of well-child care. Participation in well-child care does seem to provide substantial satisfaction to both parents and providers, and the value of their satisfaction should not be overlooked.

### **Effectiveness of Five Specific Components of Well-Child Care**

Given that the evidence on the effectiveness of well-child care as a whole is very sparse, it is worth looking at the components of well-child care to ascertain whether evidence on these pro-

cedures allows for judgments about their effectiveness. OTA selected five specific components of the well-child visit for a review of the available evidence:

1. the general physical examination,
2. the Denver Developmental Screening Test (DDST),
3. screening to detect iron deficiency (anemia),
4. screening to detect hearing deficits, and
5. anticipatory guidance on child safety restraint use.

The evidence on three of these components—the physical examination, the DDST, and anticipatory guidance on child safety restraints—is summarized in appendix J. Other components of well-child care—including vision screening and dental examinations—are not reviewed in the discussion that follows. The purpose of the discussion of the effectiveness of specific components of well-child care below is not to be comprehensive, but to illustrate the kinds of evidence available on the effectiveness of commonly recommended procedures.

The effectiveness of one component of well-child care—childhood immunization—is well established. Childhood immunizations for poliomyelitis, DTP, MMR, and Hib clearly prevent illness or premature death due to certain diseases (358).

#### **General Physical Examination**

The general physical examination is a series of diagnostic tests intended to detect a variety of medical conditions. The literature evaluating the physical examination in well-child care is summarized in table J-6 in appendix J. In general, the literature does not endorse the usefulness of the exam. The exam detected previously unknown abnormalities in 1 to 3 percent of routine exams of preschool and 5 percent of school-aged children (30, 464,770). Followup exams resulted in fewer newly diagnosed conditions than initial exams, with 1 out of every 251 exams yielding new information (771). Studies comparing exams by physicians with exams or screening of school-age children by other health professionals (e. g., nurses or technicians) found that many more abnormalities were detected in school-based screening programs than by physicians (129,221,347,746). Many of the abnormalities detected in these studies were vision

or hearing abnormalities on which the physicians may have placed little emphasis, knowing that they would be performed at school.

All but one of the studies examining the effectiveness of the general physical examination (with or without screening measures for hearing or vision defects) concluded the exam has little merit. The most glaring weaknesses of available studies are that none of the studies test the validity of either positive or negative findings obtained on examination and that none examine the clinical usefulness of finding physical abnormalities. (In one study of the physical examination in infants, over one-half of the abnormalities found were already known to the parent.) Therefore, it is not possible to gauge the effectiveness of the exam.<sup>12</sup>

#### The Denver Developmental Screening Test (DDST)

The most widely used and recommended developmental screening tool for use by child health personnel is the DDST or one of its adaptations—the DDST-S or the Parents' Developmental Questionnaire (15,96,187). The primary purpose of administering the DDST is to identify children likely to have later problems so that interventions can be used early enough to prevent the problems, although other reasons include reassuring parents that their child is normal.

The cumulative evidence suggests that the DDST, when administered immediately prior to school entry, has fair ability to predict developmental abnormalities accurately (87,88,524,629) (see table J-7 in app. J). The very limited evidence presented to date, however, does not support the assumption that detection of a problem will result in improvement in school performance; indeed, the parents of children with problems seem to worry more with no improvement in outcome (87).

OTA found no specific studies on whether identification of developmental delay through the use of the DDST for children of preschool age is a

<sup>12</sup>OTA did not review studies examining the effectiveness of specific physical diagnostic procedures, such as the Ortolani maneuver for identification of congenital dysplasia of the hip, forward bending for detection of scoliosis, patch testing for discovery of strabismus, or abdominal palpation for detection of tumors. Given the focused nature of these examinations, their effectiveness should be easier to clarify than that of the general examination.

useful effort. The recent results of programs offering early intervention are encouraging (568,587,749), but eligibility for participation in these programs is usually determined by the socioeconomic and demographic characteristics of the child's family rather than by the child's developmental scores. If the use of the DDST, or comparable tests, is to be recommended in the context of well-child care, this recommendation must be based on intuitive or philosophic rather than scientific grounds.

#### Screening To Detect Iron Deficiency (Anemia)

Anemia is a condition that exists when the level of hemoglobin in a person's blood drops below 11 grams per deciliter of whole blood (186), signifying a reduction in the oxygen-carrying capacity of the blood. In unselected populations of children, the overwhelmingly predominant cause of anemia is iron deficiency (186). Indeed, screening for anemia in infancy and childhood is recommended, in large measure, as a screen for iron deficiency.

The prevalence of anemia in a population has long been used as a measure of that population's health status, socioeconomic status, and quality of medical care (186,327). From 10 to 40 percent of infants 12 to 24 months old (depending on race and socioeconomic status) are somewhat anemic (292), although severe anemia is far less prevalent (728).

Studies differ on whether being anemic per se is harmful (388,500). Available studies do suggest—but not definitively—that iron deficiency results in lowered developmental/ intelligence quotients (131,132,386,387,388,474,475,599,737,741). Most studies suggest that iron therapy results in short-term improvement on developmental tests for clearly iron-deficient and anemic children, but some studies have not supported this conclusion, and longer term effects are even more uncertain.

Iron therapy rapidly corrects anemia and the biochemical markers associated with iron deficiency, although for many children, the improvements would occur (though more slowly) without therapy (132). Various studies have shown that iron therapy sometimes, though not always, reduces deficiencies in mental performance in iron-deficient children (132,386,388).

Even assuming the seriousness of iron deficiency and the effectiveness of treatment, there are problems in establishing a screening criterion for iron deficiency. The accepted standard for diagnosis of iron deficiency is response of at least 1 gram of hemoglobin per deciliter of blood to a therapeutic regimen of iron (517,599). Other tests for identifying iron deficiency also exist, but have not been tested in an unselected American population against the diagnostic standard. A study of anemic children in military families found that no single commonly used cutoff level for hemoglobin identified many more than half of the children who responded to iron therapy (141,517). Another study found that pretreatment hemoglobin level per se was the best indicator (highest sensitivity and specificity) of subsequent response to iron therapy; the FEP (free erythrocyte protoporphyrin) also performed well, especially as a screening test for more severe iron deficiency (331).

Given the potential seriousness of the defects induced by iron deficiency and the ease of addressing the hematologic manifestations, continued early identification of high-risk infants (e.g., those of low socioeconomic status) with either a capillary hemoglobin/hematocrit or FEP appears reasonable, with a liberal threshold (e. g., hemoglobin of less than 11.5 grams or FEP greater than 35 micrograms per deciliter of whole blood) for institution of a trial of iron therapy.

#### Screening for Hearing Deficits in Preschoolers

AAP and other bodies concerned with hearing-impaired children recommend a threefold approach to the early detection of children with hearing problems (15):

1. identification of high-risk newborns through application of risk criteria,<sup>13</sup>
2. identification of infants and toddlers through monitoring of speech and language develop-

- ment (possibly including use of formal speech and language screening instruments), and
3. identification of preschoolers through the use of some form of formal hearing screening test.

Although the greatest burden of severe hearing loss occurs in the perinatal period, screening newborns is difficult; screening in preschoolers is relatively easy, and the focus here is on the effectiveness of screening for hearing deficits in preschoolers.

Approximately 5 to 10 percent of preschool and early school-age children have at least temporary hearing impairment as a result of the presence of middle-ear fluid (168,174,348,463). Most cases of middle-ear effusion resolve spontaneously or with the help of antibiotics over a period of weeks to months (93,400,478). Surgical drainage is also effective, although it involves risk and expense and the duration of hearing improvement may be brief (73). Whether children who experience middle-ear effusion suffer long-term problems in speech and language skills or are at increased risk for subsequent learning and behavioral disorders remains an open question. Severe bilateral conductive hearing losses, particularly at earlier stages of language development, probably do cause short-term speech and language delays (478,730).

Preschoolers are in most cases screened through the use of pure-tone audiometry, which involves having the children listen to sounds across a range of frequencies and indicating when they hear the sound. A Canadian group that tried to assess the utility of community preschool screening found that such screening was not associated with a significant decrease in the prevalence of hearing deficits (168). The failure of the screening program was ascribed to the limited effectiveness of interventions for the treatment of middle-ear effusion.

Issues surrounding the early identification of hearing deficits through screening in early childhood are surprisingly complex. Pure-tone audiometry, when properly performed, is a sensitive and specific means for detecting hearing deficits. Given the uncertain impact of most of these deficits, and the vagaries of treatment efficacy, however, whether preschool children are better off for having been tested also remains unknown.

<sup>13</sup>AAP and the Joint Committee on Infant Hearing Screening currently recommend a set of criteria for identifying high-risk infants in need of screening for hearing deficits (284). Infants who meet one or more of the criteria are referred for extensive diagnostic audiologic evaluation. The precise sensitivity and specificity of these screening tests and their optimal combination for early identification of hearing deficits are controversial (6,492).

### Anticipatory Guidance on Child Safety Restraint Use<sup>14</sup>

The provision by a health care provider of anticipatory guidance on injury prevention—specifically, guidance on the use of child safety restraints in motor vehicles—offers an excellent opportunity to evaluate the effectiveness of this aspect of well-child care. First, the outcome measure—proper use of child safety restraints—is objective. Second, the scientific underpinnings of the recommendation are clear—proper use of an approved child safety restraint will almost certainly reduce the child's likelihood of death or injury due to motor vehicle accident (538). The same degree of certainty does not exist regarding the

<sup>14</sup>For more information on preventing accidental injuries in children, see ch. 7.

value of advice about the precise timing and order of introduction of solid foods for infants or about means for preventing or modifying behavioral problems.

Studies of the use of child safety restraints in motor vehicles are summarized in table J-8 in appendix J and discussed in chapter 7. The more methodologically sophisticated studies of the impact of anticipatory guidance on the use of child safety restraints in automobiles failed to demonstrate a substantial effect, although the findings indicate that pediatricians can accelerate use of infant restraints in those likely to use such restraints eventually (523). Whether the limited efficacy of physician counseling in increasing proper use of infant restraints can be generalized to all of anticipatory guidance as usually performed is doubtful.

## COST-EFFECTIVENESS OF CHILDHOOD IMMUNIZATION

The effectiveness and safety of a vaccine is extensively tested before it is approved for marketing. Consequently, in contrast to the five components of well-child care discussed previously, the effectiveness of the currently available childhood vaccines is well understood. The remaining question is whether childhood immunization is cost-effective—i.e., whether the costs of immunization are worth the benefits they confer. The literature is richly laden with research on the cost-effectiveness of specific immunization protocols. That literature is discussed below.

### Literature Review

Many studies have analyzed the costs and effectiveness of the vaccines that are recommended for routine use in this country. Some of the more recent economic evaluations of childhood vaccination programs are summarized in table J-9 in appendix J. These studies show that childhood immunization not only yields considerable disease-reduction benefits but also offers substantial economic benefits—i. e., savings in costs that would have been incurred had the disease and its complications not been prevented (13,37,62,110,150,164,260,272,350,351,404,505,567,748,758)



Photo credit: Bristol-Myers, Evansville, IN

Childhood immunization programs bring about both reduction of disease and substantial economic benefit.

A study of measles vaccination during the first 20 years of the vaccine's licensure (1963 to 1982) found that it provided the United States an estimated net savings<sup>15</sup> of \$5.1 billion in direct and indirect costs<sup>16</sup> (62). Pertussis vaccination also

<sup>15</sup>Savings are calculated differently across studies. Some researchers include only medical costs averted, while others also estimate the value of reductions in lost productivity from the disease.

<sup>16</sup>"Direct costs and benefits" refer to medical costs incurred or averted. "Indirect costs or benefits" refer to the economic value of lost productivity incurred or averted.



confers substantial net economic benefits. A recent study found that over a 6-year period for a hypothetical cohort of 1 million children, a pertussis vaccination program prevented over 92,000 cases; in addition, such a program saved a total of \$44 million in direct lifetime medical costs for the cohort of 1 million children (272).

Combining single vaccines into one vaccine for multiple diseases improves the economic benefits of vaccination by decreasing the cost of vaccine administration. In 1983, the use of a combined MMR vaccine rather than individual vaccines for measles, mumps, and rubella saved \$60 million in direct medical costs and increased productivity (748).

A study of Hib vaccination found net savings in societal medical care costs (110). That study also assessed the cost and effectiveness of administering Hib vaccine to young children at different ages. The most cost-effective Hib vaccination strategy proved to be immunization at 18 months of age, with net medical care savings of \$30.7 million. Hib vaccination at 24 months of age was also cost saving, but with a net savings of only \$1.1 million. The considerable difference in cost savings was due to the study's assumption that the 18-month Hib vaccination would be administered at the same physician visit as the already routine DTP vaccine, thus avoiding the administrative cost of an additional doctor visit that would be required at 24 months (110). The adoption of ACIP's recent recommendation to move the 18-month DTP and OPV immunizations to the 15-month visit would mean that the cost of an 18-month Hib vaccination would have to include the cost of an additional doctor visit. Assuming a \$10 office visit cost, including the cost of a doctor visit would increase the 18-month Hib vaccination cost by about \$30 million, which would nearly erase the reported net savings to an 18-month strategy. If the researchers had estimated the office visit fee at \$15, Hib vaccination would no longer provide net savings in health care costs at either 18 or 24 months, but would still confer substantial medical benefits in reduced morbidity and mortality.

Critics of the Hib vaccination study have also observed that it is based on the assumption that the Hib polysaccharide vaccine is effective in the 18- to 23-month-old population (220). A randomized controlled trial of clinical efficacy conducted in Finland found that the Hib vaccine was 90 percent efficacious in children 24 months or older (483). However, the data for that study were insufficient to determine efficacy for the subgroup of children immunized at 18 to 23 months (220). The Hib polysaccharide vaccine is clearly not efficacious in children under 18 months of age (482).

A more recent study of Hib vaccination found that universal vaccination at 24 months resulted in net savings of \$4 million (260), compared to \$1.1 million in the earlier study (110). In broadening the analysis to include indirect costs and benefits (i.e., lost lifetime earnings due to Hib), the investigators found that the 24-month strategy would result in a net savings of \$64.8 million.

A newly developed varicella (chickenpox) vaccine may soon be licensed for use in high-risk groups in the United States (505). One study found that over a 30-year period, a childhood varicella vaccination program would result in a net savings of \$252 million in direct medical costs (505). However, this study did not consider the possible increased risk of disease in adults, in whom the disease is more serious. 17 If vaccinating all children against varicella does not place adults at increased risk of disease, then there would be substantial direct medical cost savings by implementing such an addition to the childhood immunization program (505).

### **Impact of Vaccine Costs on Estimates of Net Cost Savings**

Over the past few years, as a result of the vaccine liability crisis, vaccine prices have risen dramatically (654). The burden of liability litigation

<sup>17</sup>Concern has been raised about the long-term efficacy of the varicella vaccine (743). Varicella (chickenpox) is much more severe when contracted during adulthood than during childhood. Critics assert that vaccinating all children against varicella could leave those children at increased risk of susceptibility in later years (75).

imposed on vaccine manufacturers has caused several manufacturers to pull out of the market and others to dramatically raise vaccine prices. The primary problem is the uncertain legal environment that manufacturers face regarding lawsuits over adverse reactions to vaccines (three-fifths of which are over the DTP vaccine (654)).

OTA analyzed the sensitivity of the results of the most recent pertussis cost-effectiveness study (272) to assumptions about increased current pertussis-component prices. The 1984 cost-effectiveness study assumed that the cost of pertussis vaccine was \$0.03 per dose, and found the ratio of savings in direct medical costs to the costs of a pertussis vaccination program to be 11.1 to 1 (272). Subsequently, as a result of the vaccine liability crisis, the cost of the pertussis vaccine rose sharply. In 1987, the Federal Government paid \$7.69 per dose for the pertussis component of the DTP vaccine, and the private sector price was \$8.92 (739), most of which was added to cover the costs of legal liability (287). If the study's calculations are adjusted to reflect these current prices, the ratio of savings in direct medical costs to the costs of a pertussis vaccination program drops from 11.1:1 to 1.29:1 at the government price and to 1.13:1 at the private sector price (see table 6-5). A ratio of 1.0:1.0 means that a vaccine pays for itself in reductions in direct medical care costs alone. At the government price and

even at the private sector price, therefore, DTP still pays for itself in reductions in direct medical care costs alone.

### Conclusions About the Cost-Effectiveness of Childhood Immunization

The cost-effectiveness of childhood vaccines is well established in the literature—indeed, such vaccines not only confer medical benefits but are cost-saving. Two recent cost-effectiveness studies demonstrate that the new Hib vaccine is cost-saving as well. Despite a rapid rise in price, the most controversial vaccine—DTP vaccine—continues to be cost-saving. As vaccine prices increase, however, costs saved with childhood immunization programs diminish. Thus, developments with regard to the current vaccine liability crisis will have an impact on whether childhood immunizations continue to be cost-saving.

New technologies on the horizon also will have an impact on the cost-effectiveness of childhood immunizations. Two new DTP vaccines developed by the U.S. National Institutes of Health and Japanese researchers could substantially reduce the number and seriousness of adverse reactions to the pertussis component of the vaccine. A reduction in adverse reactions could decrease the amount of corresponding litigation and ultimately reduce vaccine prices.

**Table 6-5.—Impact of Vaccine Prices on the Cost-Effectiveness of Pertussis Vaccine**

Pertussis vaccine price per dose <sup>a</sup>	Savings-to-cost ratio <sup>b</sup>	Cost reduction in net medical costs attributable to pertussis vaccine
Price estimated by Hinman and Koplan, 1984 <sup>c</sup> . . . . . \$0.03	11.1:1	820/0
Federal Government price in 1987 . . . . . \$7.69	1.29:1	20%/0
Private sector price in 1987 . . . . . \$8.92	1.13:1	180/0

<sup>a</sup>Price of DTP vaccine minus price of diphtheria and tetanus components of the vaccine

<sup>b</sup>Ratio of savings in direct medical costs to the costs of pertussis vaccine

<sup>c</sup>A. R. Hinman and J. P. Koplan, "Pertussis and Pertussis Vaccine: Reanalysis of Benefits, Risks, and Costs," *JAMA* 251(23):3109-3113, 1984

SOURCE: P. Home, Division of Immunization, Centers for Disease Control, Public Health Service, U.S. Department of Health and Human Services, personal communication, Atlanta, GA, January 1987; Washington Report on Medicine and Health, "Lederle, Connaught Drop DPT Prices," *Washington Report on Medicine and Health* 41(20) 2, May 18, 1987; and OTA calculations.

## FINANCING AND AVAILABILITY OF WELL-CHILD CARE SERVICES

Children with private health insurance in the United States, with the exception of children in HMOs, are seldom covered for well-child care services. As discussed below, however, the Federal Government supports well-child care services through a variety of programs, ranging from Medicaid to childhood immunization programs.

The discussion of the availability of well-child services below focuses on the most clearly effective and cost-effective component: childhood immunization. Children in the United States are routinely immunized against polio and several other diseases. In part because States have laws requiring proof of immunization prior to school entry, the percentage of children entering schools who have had their basic immunizations in the United States is very high. In contrast, immunization levels of children at 2 years of age are well below the objectives for 1990 set by the U.S. Public Health Service.

### Private Insurance Coverage of Well-Child Care Services

Preventive health services such as well-child care visits or childhood immunizations are infrequently a benefit under private health insurance plans. Only recently have some insurers offered preventive health plans for privately insured children (405). Even when coverage of preventive services is included in a benefit package, however, effective coverage is limited by the nearly universal existence of first-dollar deductible requirements.<sup>18</sup>

In contrast, virtually all HMOs provide preventive health services in their insurance plans. Indeed, the provision of well-child care is required of HMOs for them to be federally qualified. (One-half of all HMOs are federally qualified (297).) As of January 1, 1987, 28 million people in the United States were enrolled in HMOs, accounting for 11.7 percent of the U.S. population (264). Furthermore, the number of HMO enrollees is growing rapidly (a rate of 25 percent per year at the end of 1986) (264).

<sup>18</sup>About 90 percent of all employer-based private health plans have deductibles of \$100 or more (768).

### Medicaid Coverage of Well-Child Care for Eligible Poor Children

As the major third-party payer for health care of very poor children, Medicaid's policies toward the provision of well-child care have a great deal to do with how much and what kinds of services these children receive. Although under one-half of all children in poverty are eligible for Medicaid (see ch. 3), the children who are eligible are covered for a range of well-child care services that greatly exceeds those services covered by private insurance plans.

Well-child care is provided to Medicaid children through two avenues. In some States, the State covers well-child care visits under its basic Medicaid plan. As of 1985, 32 States explicitly allowed private practitioners to bill for routine pediatric examinations (544), and others may allow this practice by lax utilization controls. " In all States, well-child care services are covered through the EPSDT program. The EPSDT program is a federally mandated program of preventive and comprehensive services that States must make available to all categorically eligible Medicaid children. It is intended to be a comprehensive system that combines screening for health problems with outreach, followup care, and case management to ensure that health problems identified in screening visits are actually addressed.

The EPSDT program was established by Congress in 1967 but was implemented exceedingly slowly by both the Federal Government and the States (10,544). Final regulations governing the implementation of the program did not take effect until January 1985. During this long period, States proceeded at varying speeds to set up EPSDT programs. State EPSDT programs vary in their design and organization, and in most States, EPSDT services have been used by only a minority of Medicaid-eligible children (508).

<sup>19</sup>Not much is known about the amount, kinds, or quality of services rendered in this way, but in one State (Michigan) about 7 percent of physician and ambulatory care visits reimbursed by Medicaid for children in families receiving Aid to Families With Dependent Children in 1983 were for routine checkups (469).



Photo credit. March of Dimes Birth Defects Foundation

Medicaid's Early and Periodic Screening, Diagnosis, and Treatment program is the major third-party payer for well-child care of very poor children.

The legislative mandate and Federal regulations for EPSDT do not require a particular organization, but they do specify requirements such as the following for the structure of the delivery of care and, to a lesser extent, the content of that care:

- informing eligible clients of the availability of EPSDT services;
- providing transportation and appointment scheduling assistance;
- providing screening services to children that include regularly scheduled examinations and evaluations of physical and mental health;
- providing diagnostic and treatment services for any problems uncovered in a child's screening visit, if the services are covered in the State's Medicaid plan;<sup>20</sup> and
- setting standards and a system for achieving timeliness of provision of EPSDT services.

<sup>20</sup>Vision, dental, and hearing treatment must be supplied to screened children regardless of whether they are covered in the State's plan (49 FR 43654),

In all 50 States, the families of children eligible for EPSDT are informed at the point at which application is made for Medicaid benefits, but 30 States make additional outreach efforts such as scheduling a visit at the time of initial application or recruiting through Head Start programs, day-care centers, and hospitals (508). Such outreach efforts were originally encouraged by EPSDT legislation, which paid at a higher Federal matching rate for administrative costs associated with EPSDT than the Federal matching rate for the regular Medicaid program. In 1981, however, that extra match was eliminated.

Despite many innovative attempts by States to enhance children's participation in the EPSDT program, it remains unclear what approaches work for specific kinds of populations. An evaluation of 15 demonstration programs in both 1972 and 1978 was unable to identify strategies that were particularly successful in increasing the low rates at which children were screened (519). In fiscal year 1985, only 18 percent of the eligible population was screened, the same percentage as had been screened in fiscal year 1981 (508).

Once a child is entered into the EPSDT program, the first encounter is the screening visit. Depending on the State, the screening visit may be to a private physician's office (in Wisconsin, 70 percent of all screens are performed by private physicians), a health department screening clinic (in Michigan, over 90 percent of all screens take place in public clinics), or some other provider (508). If a health problem is identified in a screening visit, the child is referred for further diagnosis and treatment. Referrals requiring a followup visit, either to the screening clinic or to another provider, tend to reduce the rate of resolution of problems identified on the screen (519).<sup>21</sup>

The 1985 Federal EPSDT regulations gave States incentives to develop arrangements with "continuing-care providers," who would be required to provide the full range of EPSDT screening, diagnosis, treatment, and referral for followup services as well as all physician services under

<sup>21</sup>Federal regulations require that immunizations be provided at the time of screening if medically necessary and appropriate.

Medicaid.<sup>22</sup> The goal of the regulations was to improve the continuity of care provided to Medicaid children. States appear to be entering into these continuing-care agreements as part of a more general effort to enroll Medicaid recipients in primary care case-management plans authorized by the Omnibus Budget Reconciliation Act of 1981 (Public Law 97-35) (544). Most of these continuing-care arrangements are with private physician practices or HMOs, although some States are recruiting publicly funded clinics (544). About 8 percent of EPSDT eligible children were enrolled in continuing-care arrangements in 1986 (273).

Several important issues regarding Medicaid's policy with respect to EPSDT have been raised by critics of the program. Several of them are discussed in turn below.

**Adequacy of State EPSDT Protocols.—Most States (42 of 46 surveyed in 1985) have established schedules for well-child care visits under EPSDT that involve fewer visits than the number currently recommended by AAP (544). Little is known about the impact of fewer well-child visits on health outcomes. Indeed, most nonpoor children do not receive the full complement of well-child visits recommended by AAP. However, it is impossible to say whether a schedule with less frequent visits is acceptable for poor children, who are more likely than nonpoor children to have health problems.**

**Discontinuity of Care Due to Volatility of Eligibility for Medicaid.—A large proportion of the children eligible for Medicaid are eligible for only a part of a year (86). If a lapse in Medicaid eligibility prevents a child from continuing in the care of a health care provider that the child has been using while under Medicaid, this situation may disrupt continuity of care. Some observers argue that States should make greater efforts to enlist publicly funded clinics that serve Medicaid-ineligible populations—e.g., community health centers or public outpatient clinics—as EPSDT continuing-care providers (544). If such clinics were EPSDT continuing-care providers, then**

when children lost their Medicaid eligibility, their continuity of care could be maintained with the same clinic. Of course, this approach would mean channeling Medicaid children to a health care delivery system separate from that used by other, more affluent children.

**Need To Recruit Private Providers Into the EPSDT Program.—**The low screening ratios for Medicaid children under EPSDT appear to result in part from low participation by private physicians in the EPSDT program. Two States found that enhanced efforts to recruit private providers into the EPSDT program increased the screening ratio (401,732). It is not clear, though, whether such changes reflect a real increase in the amount of well-child care provided or merely a switch from the provision of such services under the regular Medicaid program to the EPSDT program. Private physicians' provision of EPSDT screens may reduce physical barriers to these services, enhance the doctor-patient relationship, and improve access to episodic acute care. On the other hand, some private physicians may be less able to provide a comprehensive array of services than a publicly funded clinic.

**EPSDT v. Regular Medicaid Coverage of Well-Child Care Services.—**The poor rates of participation in EPSDT by eligible children clearly understate the use of and access to well-child care services among these children. Many of these children receive well-child care services through the regular Medicaid program, presumably from a private physician or publicly funded clinic. For children who are not served under EPSDT continuing-care agreements, the use of the regular Medicaid program may enhance the continuity of care and their access to acute care. On the other hand, EPSDT services include augmented vision, hearing, dental, and sometimes other services not available through the regular Medicaid program. Indeed, under EPSDT (unlike the rest of Medicaid), a State may provide virtually any services it wishes on an as-needed basis to children, provided the need for the services was identified through an EPSDT screening examination (49 FR 43654, 42 CFR 441.57).<sup>23</sup>

<sup>22</sup>Provision of dental services under these arrangements is optional, but if the continuing care provider chooses not to provide such services, then the provider must refer recipients to the Medicaid EPSDT agency to obtain these services (49 FR 43654; 42 CFR 441.60(a) (4)).

<sup>23</sup>One State uses the EPSDT program to provide home services to technology-dependent children (664).

To some extent, the development of EPSDT continuing-care arrangements by States should mitigate the problems related to the separation of regular Medicaid services from EPSDT services and bring together the two sets of services. In many areas, however, the growth of continuing-care arrangements is likely to be slow, and the choice is between providing well-child care for low-income children through channels that are convenient to private practitioners (i. e., regular Medicaid) or through channels that are subject to more monitoring and control over the quality of services (EPSDT programs).

### **Public Direct Subsidies for Well= Child Care**

A number of public programs provide or support childhood immunization services and other well-child care. A childhood immunization program that is a coordinated Federal, State, and local effort provides vaccines for approximately one-half of the children in the United States. There exists no similar coordinated effort for other well-child care; rather, well-child care for some children is obtained (or financed) through many different Federal programs.

### **Federal Support for Childhood Immunization**

**Approximately one-half of all childhood vaccines** are delivered by the public sector; the other half are delivered by the private sector (654). Vaccine manufacturers have three primary markets for their vaccines:

1. bulk and consolidated contract sales to the Federal Government,
2. bulk sales to State and local governments, and
3. retail sales to hospitals, clinics, and physicians (654).

Through the purchase of vaccines and through other research, operational, and surveillance programs, the Federal Government plays a leading role in the effort to immunize U.S. children against diseases preventable by immunization. Vaccinations are actually provided to children at the State and local level, however.

The Federal Government became involved in immunization programs for children in the 1950s, when Congress passed the Poliomyelitis Vaccination Assistance Act of 1955 (Public Law 84-377). Since then, the Federal role has been expanded, most notably through the Vaccination Assistance Act of 1962 (Public Law 87-868)—a law which provided for Federal grants to States and localities for vaccination programs. The Communicable Disease Control Amendments of 1970 (Public Law 91-464), through a newly created Section 317 of the Public Health Services Act, provided the Federal Government with authority to assist State and local governments in the prevention and control of communicable diseases. Under Section 317, States receive Federal grants for the purchase and delivery of vaccines based primarily on their population, income, public sector involvement in vaccine administration, past levels of disease, and other factors (50). States then use the grant money to purchase vaccines and deliver the vaccines through their local public health structure or, if no public health structure is available, through private physicians (286). States may be awarded vaccines in lieu of cash if so requested (50).

Several U.S. Government establishments have vaccine-related responsibilities. The National Institute of Allergy and Infectious Diseases, one of the National Institutes of Health, is involved in vaccine research and development, primarily through funding basic and epidemiological research. The Food and Drug Administration's Center for Drugs and Biologics is responsible for the licensing and testing of vaccine manufacturers and their products (658). The Center for Disease Control's (CDC) Division of Immunization is responsible for developing and implementing national goals and activities for childhood immunization,

Operating under Section 317 of the Public Health Services Act, CDC coordinates the distribution of Federal funds to State and local health departments for the purchase of vaccines. The level of Federal funding under Section 317 was increased from \$56.9 million in 1986 to \$87.5 million in 1987—in an attempt to compensate for increases in vaccine costs and births, to include the Hib vaccine in the Federal purchase program, and to establish a 6-month stockpile of childhood vaccines (286). CDC also negotiates consolidated pur-

chase contracts with manufacturers—contracts that realize savings that States could not achieve on their own. Finally, in addition to making grants to States, CDC 1) provides statistical, promotional, educational, and epidemiological assistance, as well as consultation to State and local health departments; 2) conducts a nationwide disease surveillance program; 3) monitors national immunization levels and adverse events occurring in the public sector; 4) maintains a stockpile of vaccines and injector equipment in case of epidemics or the disruption of vaccine supply; and 5) develops guidelines for the use of vaccines (654,682).

#### Other Federal Support for Well-Child Care

Federal support for well-child care goes beyond support for childhood immunization. As discussed below, well-child care for children in low-income families or special demographic categories is provided or funded by several Federal programs:

- the Maternal and Child Health (MCH) block grant program,
- the Preventive Health and Health Services (PHHS) block grant program,
- the Head Start program,
- community health centers (CHCs) and migrant health centers (MHCs), and
- the Indian Health Service (IHS) of the Public Health Service.

Because these programs provide more than well-child care, they are also discussed in more general terms in chapter 3.

The MCH block grant is used to provide health services to mothers and children, including well-child care and immunizations. It is up to each State, however, to decide exactly which services MCH funds are used for. Six States reported using MCH block grant funds for immunization in 1985, spending a total of \$670,000 (512). Information on MCH funding of other well-child care services is not available,

PHHS block grant funds are used to provide comprehensive public health services, including well-child care and immunization. Each State retains its own decisionmaking authority over how the funds are distributed for the various services

(512). Eight States reported using PHHS block grant funds for immunization in 1985, spending a total of \$730,000 (512). Information on PHHS funding of other well-child care services is not available.

Medical services provided in the Head Start program include a complete examination, including vision and hearing tests, identification of handicapping conditions, immunizations, and a dental exam. In 1985-86, 96 percent of the children enrolled in Head Start had completed all of the required immunizations and 97 percent of the children enrolled had completed medical screening, including all of the appropriate tests (675).

CHCs and MHCs are part of the Federal primary care program administered by the Bureau of Health Care Delivery and Assistance, an organizational component of the Health Resources and Services Administration. The goal of CHCs is to provide primary health care, including well-child care and immunizations, to medically underserved areas. MHCs provide primary health care, including well-child care services, to migrant and seasonal farm workers and their families.

For Indian children, IHS provides both well-child care and immunizations. IHS has been very successful in immunizing American Indian and Alaska Native children. In 1982, it achieved its goal of immunizing 90 percent of these children, attaining the Federal target level set by the 1977 Childhood Immunization Initiative, and it has maintained that level ever since (513).

#### **Access to Well-Child Care: Children's Immunization Status**

There is very little evidence on the use of well-child care services in various segments of society. A study based on the Rand health insurance experiment (see ch. 3) found that 7 percent of infants had received no well-child care in the first 18 months of life, only 45 percent had received three doses of polio and DTP vaccines, and 60 percent had received the MMR vaccine (389); however, this study was based on a very small sample size (97 subjects). Another study based on the 1980 National Medical Care Utilization and Expenditure Survey found that privately insured

individuals “rarely use preventive services at the rates indicated by medical guidelines. Only HMO enrollees are likely to use services at medically recommended levels” (45).

The most direct evidence on the use of well-child care services pertains to children’s immunization status. Immunization, of course, is only one component of well-child care. Although it is relatively easy to report on children’s immunization status, data on immunization status do not necessarily reflect children’s access to the whole array of well-child care services. At least in certain groups of children, though, a lack of immunization—the most clearly cost-effective well-child care service—implies poor access to other well-child services.

The following discussion examines U.S. children’s access to immunization services and assesses the immunization status of those children. The areas covered include the U.S. objectives for childhood immunization levels, the present immunization status of U.S. children, comparison to other industrialized countries, and gaps in access to immunization among American children.

### Variations in Children’s Immunization Status by Age

**What level** of immunization in a population is enough? The minimum level necessary to maintain herd immunity (the level of immunity that must be attained to prevent epidemics of vaccine-preventable diseases in a specific population) varies for each childhood disease. In general, if a high percentage (80 to 90 percent) of a population is immunized against a disease, there is little likelihood that the disease will be introduced into the population and infect the unimmunized individuals. For tetanus, there is no herd immunity; therefore, immunization of the entire population is necessary for complete protection.

In December 1980, the U.S. Public Health Service laid out the following two objectives as national goals for 1990:

1. that at least 95 percent of children in licensed day-care centers and kindergarten through grade 12 be fully immunized, and

2. that at least 90 percent of children have their basic immunization series by age 2 (679).

A November 1986 midcourse review of the Nation’s progress towards these goals found that the immunization status of U.S. children in the 1980s is better than it has ever been before (716).

The goal of immunizing 95 percent of U.S. children in licensed day-care centers and in kindergarten through grade 12 will probably be achieved by 1990. Immunization levels for school-age children for the 1984-85 school year were 88 percent or higher (716). Immunization levels for school-entry-aged children (5- and 6-year-olds) have consistently been in the 91- to 94-percent range throughout the 1980s, very close to the 1990 target level of 95 percent (693) (see table 6-6). This high degree of success is primarily due to the fact that all States have laws requiring proof of immunization prior to school entry (49). Reported immunization levels for children in licensed day-care centers are also nearing the target level of 95 percent. In 1985-86, according to the Licensed Day Care Center Facilities Immunization Survey, day-care centers reported that 93 percent or more children had had their basic immunization series (590).

In contrast, immunization levels for U.S. children at 2 years of age are well below the 1990 objectives and have shown little progress since 1980.<sup>24</sup> With the exception of DTP immunization levels for 3+ doses, the immunization levels for 2-year-olds are well below the 1990 target of 90 percent (see table 6-7). In 1985, just over one-half of 2-year-olds had had four or more doses of DTP as recommended by ACIP’s schedule. From 1979 to 1985, immunization levels among 2-year-olds rose the most for the mumps vaccine (which had the lowest level to begin with); immunization levels for rubella vaccine among 2-year-olds actually declined slightly (see table 6-7).

<sup>24</sup>The best available national data for this age group comes from the U.S. Immunization Survey conducted by the Census Bureau for CDC. The total sample for the survey is based on the respondents recall, and there is a subsample based on the respondent referring to an immunization record as the source of immunization history. The subsample constitutes approximately one-third of the total sample (146).



**Table 6-6.—Percentage of School-Entry-Aged<sup>a</sup> U.S. Children Immunized, 1980/81 to 1985/86**

Vaccination	Percentage immunized by year					
	1980/81	1981/82	1982/83	1983/84	1984/85	1985/86
Polio (3+ doses) . . . . .	95 %/0	96/0	97%	97 %/0	97 %/0	96/0
DTP (3+ doses) . . . . .	96	96	96	97	97	96
Measles . . . . .	96	97	97	98	98	97
Mumps . . . . .	92	95	96	97	97	96
Rubella . . . . .	96	97	97	98	98	97
All vaccines <sup>b</sup> . . . . .	NA	NA	91	93	94	93

Abbreviation: DTP = diphtheria, tetanus, and pertussis vaccine

NA = not available

<sup>a</sup>Five- to six-year-olds

<sup>b</sup>The percentages shown in this line represent the weighted average of the individual vaccine percentage, but it may be an Unrepresentative sample because not all States reported overall percentages

SOURCE U S Department of Health and Human Services, Public Health Service, Centers for Disease Control, unpublished data from the U S School Entry Immunization Survey, 1980/81-1986, Atlanta, GA, 1987

**Table 6-7.—Percentage of 2-Year-Old U.S. Children Immunized, 1979 and 1985**

Vaccination	Percentage immunized by year	
	1979	1985
Polio (3+ doses) . . . . .	76.30/0	76.70/0
DTP (3+ doses) . . . . .	82.1	85.8
(4+ doses) . . . . .	53.6	55.7
Measles . . . . .	80.8	81.7
Mumps . . . . .	70.1	78.9
Rubella . . . . .	80.0	77.3

Abbreviation: DTP = diphtheria, tetanus, and pertussis vaccine

SOURCE U S Department of Health and Human Services, Public Health Service, Centers for Disease Control, unpublished data from the U S Immunization Survey, 1979/1986, Atlanta, GA, 1987

The United States has significantly lower immunization levels for infants than several other industrialized countries have. The percentage of infants (0 to 1 year of age) in the United States who are fully immunized against DTP (37.4 percent) is less than one-half the percentage in the United Kingdom (84 percent), Canada (80 percent), Sweden (94 percent, DT only), France (95 percent), Spain (97 percent), Italy (99 percent, DT only), and Israel (95 percent) (723,765).

Why has the United States been so successful at achieving the school-age immunization objectives, yet less successful with the preschool age population? In contrast to school-age children, preschool children lack a universal point (e.g., school entry) at which immunization can be required. Day care is the most common point of access for immunization in preschoolers, and most States have already enacted laws that require proof of immunization in order to attend day care (686). However, five States do not have such re-

quirements and five other States have no enforcement clause for the requirements that they do have (686). And even in States where laws exist, their effect is weakened by the fact that the requirements apply only to licensed day-care facilities, which care for an estimated 20 percent of children under age 6 with working parents (the other 80 percent are in informal day care of some kind) (526).

### Variations in Children's Immunization Status by Race and Location

Although it is apparent that the United States enjoys high levels of immunization as a whole, though not as high as they should be for very young children, considerable differences persist with respect to race and geographic location. National survey data indicate that differences exist between white and nonwhite as well as between urban poverty areas and suburban and rural areas.

Table 6-8 illustrates that whites have higher immunization levels than nonwhites in both the preschool and school-entry child populations. For children aged 1 to 4 in 1985, the differential ranged from as high as 16 percent for polio vaccination to 10.9 percent for measles and rubella (see table 6-8). For children aged 5 to 6 in 1985, the range was from 12.1 percent for polio (3+ doses) to 8.4 percent for DTP (3+ doses) (table 6-9).<sup>25</sup> Immu-

<sup>25</sup>The figures for DTP and OPV (oral polio vaccine) in 5- and 6-year-olds are the percentage of children with three or more doses, the number used in the data as the minimally acceptable level for immunity. In fact, however, three or more doses may or may not

**Table 6-8.— Percentage of 1- to 4-Year-Olds and 5- to 6-Year-Olds Immunized by Race, 1985**

Vaccine	Percentage Immunized by race		
	All races	White	Nonwhite
<b>1- to 4-year-olds:</b>			
Polio (3+ doses)	75.7 %	77.5 %	61.5 %
DTP (3+ doses)	87.0	88.5	75.2
Measles <sup>a</sup>	76.9	78.1	67.2
Mumps <sup>a</sup>	75.5	77.1	62.7
Rubella <sup>a</sup>	73.8	75.0	64.1
<b>5- to 6-year-olds:</b>			
Polio (3+ doses)	<b>87.3%</b>	<b>88.6 %</b>	<b>76.5 %</b>
Polio (4+ doses)	71.3	73.2	54.5
DTP (3+ doses)	93.4	94.3	85.9
DTP (4+ doses)	85.1	86.6	71.8
Measles <sup>a</sup>	89.0	90.0	80.0
Mumps <sup>a</sup>	88.7	89.7	80.4
Rubella <sup>a</sup>	84.7	85.9	74.1

Abbreviation: DTP diphtheria, tetanus and pertussis vaccine  
<sup>a</sup>Measles mumps and rubella levels are not identical because some States do not require vaccination against mumps and/or rubella

SOURCE U S Department of Health and Human Services Public Health Service Centers for Disease Control unpublished data from the U S Immunization Survey 1979 1986 Atlanta GA 1987

be an adequate cutoff, depending on when each dose is administered. The primary series of vaccination against polio has three doses. The fourth booster dose may not be necessary if the child has not followed the recommended schedule and received the third dose after the fourth birthday (681). Four doses of DTP make up the primary vaccination series, and the fifth booster shot is required unless the fourth dose was received after a child's fourth birthday which means that the recommended schedule was not followed. For a measure of the percentage of children that are following the recommended

nization levels for nonwhites with 4 or more doses drops considerably, as low as 54.5 percent for OPV in 1985.

The geographical distribution of immunization levels in 1985 are presented in table 6-9. Immunization levels in central cities are substantially lower than in non-central-city regions for both preschool age and school-entry age children. In 1985, 31 percent of preschoolers living in central cities were not adequately immunized against polio; 30 percent against mumps. Almost one-fifth of 5- to 6-year-old children living in central cities have not received three or more doses of polio vaccine, the minimally acceptable level for immunity. Nearly two-fifths of that group have not received the optimal four or more doses of polio vaccine. Many illegal aliens living in central cities are unimmunized (287). The Immigration Reform and Control Act of 1986 (Public Law 99-603) may bring these children into the public health system and improve immunization levels in central cities.

immunization schedule, therefore, it is appropriate to look at those who have received four or more doses of DTP and OPV. Although it is possible not to follow the recommended schedule and still be immune to disease, the highest degree of immunity achieved when the recommended schedule is followed.

**Table 6-9.— Percentage of 1- to 4-Year-Olds and 5- to 6-Year-Olds Immunized by Place of Residence, 1985**

Vaccine	Percentage immunized in SMSAs		Percentage immunized in non-SMSA areas
	Central cities	Other SMSA areas	
<b>1. to 4-year-olds:</b>			
Polio (3+ doses)	68.9%	79.6 %	75.9 %
DTP (3+ doses)	79.6	89.7	88.6
Measles <sup>a</sup>	73.5	76.7	79.0
Mumps <sup>a</sup>	70.5	76.8	77.0
Rubella <sup>a</sup>	70.4	75.0	74.6
<b>5- to 6-year-olds:</b>			
Polio (3+ doses)	81.6 %	91.0 %	86.7 %
Polio (4+ doses)	63.8	<b>74.2</b>	72.4
DTP (3+ doses)	87.5	<b>96.5</b>	93.5
DTP (4+ doses)	77.1	<b>88.5</b>	86.0
Measles <sup>a</sup>	81.6	<b>90.7</b>	91.2
Mumps <sup>a</sup>	81.4	90.6	90.7
Rubella <sup>a</sup>	75.0	88.7	85.9

Abbreviations: DTP diphtheria tetanus, and pertussis vaccine SMSA Standard Metropolitan Statistical Area  
<sup>a</sup>Measles mumps and rubella levels are not identical because some States do not require vaccination against mumps and/or rubella

SOURCE U S Department of Health and Human Services Public Health Service Centers for Disease Control unpublished data from the U S Immunization Survey 1979 1986 Atlanta GA, 1987

The lower levels of immunization in central cities indicate a higher susceptibility to outbreaks of vaccine-preventable diseases. New York City experienced outbreaks of rubella each spring from 1983 to 1985. There were 184 cases reported for 1985 (691). In the first 6 months of 1986, there

were 80 outbreaks of measles, the largest occurring in New York City (688). Despite the high overall levels of immunization in the United States, there is a need to close the gap in levels between central cities and non-central cities to better control vaccine-preventable childhood diseases.

## CONCLUSIONS

Of the components of well-child care examined in this chapter, immunization is the one proven to be cost-effective and cost-saving. A schedule of well-child care visits that corresponds to at least the recommended schedule for childhood immunization, therefore, is cost-effective and probably cost-saving. Such a schedule would include only 7 well-child care visits for normal infants and children in the first 6 years of life rather than the 13 visits currently recommended by AAP.

Whether more well-child care visits than the number required for childhood immunizations would be cost-effective is unknown, because researchers have yet to be able to document the effectiveness of the nonimmunization aspects of well-child care in terms of improved health outcomes. To formulate recommended schedules of well-child care visits, AAP and other recommend-

ing bodies have relied on expert opinion regarding the effectiveness of nonimmunization components of well-child care (284). It may be that well-child care has but a modest effect on health outcomes that is undetectable by the research designs employed to date. Giving a child access to a continuous source of medical care and providing support and reassurance for families of young children are proposed as benefits of well-child care. In the absence of clearer evidence regarding the effects of the nonimmunization aspects of well-child care on children's health outcomes, the effects of these factors on children's health are difficult to evaluate. Consequently, decisions regarding the appropriate number of well-child visits requires consideration of both the objective and subjective factors,

Chapter 7

# **Prevention of Accidental Childhood Injuries**

# CONTENTS

	<i>Page</i>
<b>Introduction</b> .....	<b>147</b>
<b>The Problem of Accidental Injuries</b> .....	<b>147</b>
<b>Causes of Accidental Injuries in Children of Different Ages</b> . . . . .	<b>149</b>
<b>Social and Economic Differences in Accident Rates</b> . . . . .	<b>149</b>
<b>Injury Epidemiology and the Identification of Countermeasures</b> .. ...	<b>150</b>
<b>Effectiveness of Prevention Strategies</b> . . . . .	<b>152</b>
<b>Persuasion/Education</b> . . . . .	<b>152</b>
<b>Regulation of Behavior</b> . . . . .	<b>154</b>
<b>Automatic Protection</b> . . . . .	<b>157</b>
<b>The Costs of Accident Prevention</b> . . . . .	<b>160</b>
<b>Federal Agencies Involved in Prevention Efforts</b> . . . . .	<b>161</b>
<b>Conclusions</b> . . . . .	<b>163</b>

## Boxes

<i>Box NO.</i>	<i>Page</i>
<b>7-A. Example of a Successful Strategy To Prevent Fatal Childhood Injuries From Falls</b> . . . . .	<b>158</b>
<b>7-B. Federal Injury Prevention Assistance</b> . . . . .	<b>162</b>

## Figure

<i>Figure No.</i>	<i>Page</i>
<b>7-1. Attenuation of the Effect of a Public Education Program</b> . . . . .	<b>153</b>

## Tables

<i>Table No.</i>	<i>Page</i>
<b>7-1. Number of Accidental Fatalities in Children Under Age 15, by Age Group and Type of Accident, 1984</b> . . . . .	<b>148</b>
<b>7-2. Preventing Motor-Vehicle/Child-Pedestrian Injuries: Potential Targets for Accident Intervention</b> . . . . .	<b>150</b>
<b>7-3. General Countermeasures to Hazards: Examples of Their Application to Two Specific Hazards</b> . . . . .	<b>151</b>
<b>7-4. Comparison of Child Safety Restraint Laws in 50 States and the District of Columbia, June 1987</b> . . . . .	<b>156</b>

# Prevention of Accidental Childhood Injuries<sup>1</sup>

## INTRODUCTION

Accidental injuries are the leading cause of death in children after the first few months of life.<sup>2</sup> In 1984, 7,850 children under age 15 died as a result of such injuries (713). The exact number of children who are treated in emergency rooms or hospitalized for accidental injuries is not known. However, accidental and other injuries clearly account for a substantial proportion of the medical care received by children in hospitals. Children under age 15 make nearly 10 million emergency room visits due to injuries each year, and about 1 in every 130 children each year is hospitalized for injury (538). At current rates, about 1 of every 9 children born today will be hospitalized for injury before the age of 15. Although these statistics do include child abuse and self-inflicted injuries, the vast majority of injuries sustained by children are accidental (38).

The prominence of injuries as a cause of death and disability in children is largely due to society's success in reducing the incidence of severe

<sup>1</sup>This chapter is based in part on a background paper on unintentional injuries prepared for OTA by L.S. Robertson (538). OTA, however, takes full responsibility for the use of that information in this chapter and for the use of the phrase "accidental injuries" rather than "unintentional injuries."

<sup>2</sup>To describe accidental injuries, many people prefer the label "unintentional injuries" because they believe that the term "accidental" implies unavailability, OTA has chosen to use the term "accidental injuries" for two reasons. One is that it is the term more commonly used by the general public. The other is that many researchers in the field of child abuse argue that the term "unintentional injuries" does not in fact exclude all injuries due to child abuse, because some child abuse is unintentional.

infectious diseases, not to an increase in injuries themselves. In fact, many interventions to prevent and treat accidental injuries have met with considerable success, and accidental deaths among children under age 15 have been declining. Whereas there were 11,736 accidental deaths among children under age 15 in 1975 (1 per 4,632 children) (534), there were 9,703 such deaths in 1980 (1 per 5,286 children) (452); and only 7,850 such deaths in 1984 (1 per 6,606 children) (713).<sup>3</sup>

This chapter describes the magnitude of the problem of accidental childhood injuries, the major causes of accidental injuries, the groups of children such injuries affect, and an epidemiological model for examining the causes of these injuries and conceptualizing interventions. The bulk of the chapter considers the effectiveness of specific strategies in preventing accidental injuries. These strategies fall into three general categories:

1. persuasion/education,
2. regulation of behavior, and
3. automatic protection.

Finally, the chapter considers the costs of accident prevention and the role of the Federal Government in this area.

<sup>3</sup>A small part of the decrease during this period may be due to the fact that the overall child population was declining at the same time.

## THE PROBLEM OF ACCIDENTAL INJURIES

As a group, injuries (accidental and other) are the leading cause of potential years of life lost before age **65 (685)**. In infants under age 1, injuries are the second leading cause of death (after death

due to conditions present at birth); and in all other children under age 15, they are the leading cause of death (**451**). In 1984, as shown in table 7-1, most of the accidental fatalities in children under

age 15 resulted from vehicle-related accidents. Drowning and fires/burns were also prominent causes of death among children in this age group.

More is known about fatal accidental injuries than about accidents that do not result in death. The fatality statistics in table 7-I are compiled from death certificates and published by the National Center for Health Statistics (NCHS). As described in appendix K, there are five major national sources of accidental injury data, each with limitations:

1. death certificates,
2. hospital discharge abstracts,
3. hospital emergency room reports,
4. national health survey data, and
5. traffic accident data.

None of these sources provides reliable national estimates of hospitalization for injuries. Death certificates include information on the cause of death and thus can yield injury fatality statistics such as those in table 7-1. Similar national data on hospitalizations by cause of injury, however, are not available. Hospital discharge abstracts do pro-

vide information on what types of injuries patients admitted to the hospital have (e. g., fractures, burns), but these abstracts do not typically provide any information on injury causes (or even information on whether injuries are accidental or not). Emergency room data are collected consistently only for injuries associated with products under the surveillance of the Consumer Product Safety Commission (CPSC). And, similarly, neither health survey data nor traffic accident data are both specific and comprehensive.

Even though there are no national data on hospitalizations for childhood injuries, there are some State-specific data. Data from Massachusetts for the year 1980-81, for example, indicate an annual rate of hospital admissions due to injury of 7.7 per 1,000 children aged 0 to 19 and an emergency room treatment rate of 216 per 1,000 children (234). North Carolina has reported a similar injury hospitalization rate of 8 admissions per 1,000 children aged 0 to 19 in 1980 (554). These data suggest ratios of about 45 hospitalizations and 1,271 emergency room treatments for each death. Nationally, these figures imply that approximately 353,000 hospitalizations and nearly 10 million

**Table 7.1.—Number of Accidental Fatalities in Children Under Age 15, by Age Group and Type of Accident, 1984**

Type of accident	Number of fatalities by age group					
	0-4 yr			5-9 yr	10-14 yr	Total, 0-14 yr
	< 1 yr	1-4 yr	Total, 0-4 yr			
<b>Vehicle-related accidents:</b>						
Motor vehicle accidents . . . . .	161	977	1,138	1,016	1,247	3,401
<i>Person killed:</i>						
Motor vehicle occupant . . . . .	115	349	464	289	420	1,173
Pedestrian . . . . .	14	502	516	488	321	1,325
Pedal cycle occupant . . . . .	0	17	17	109	218	344
Motorcycle occupant . . . . .	0	4	4	22	98	124
Other/unspecified . . . . .	32	105	137	108	190	435
Air, rail, and water craft accidents. . . . .	1	31	32	31	75	138
Other vehicle accidents . . . . .	0	9	9	17	24	50
<b>Non-vehicle-related accidents:</b>						
Fires and burns . . . . .	139	641	780	325	183	1,288
Drowning . . . . .	70	556	626	229	265	1,120
Choking <sup>a</sup> . . . . .	153	118	271	17	28	316
Firearms and explosives . . . . .	0	39	39	69	190	298
Falls . . . . .	28	86	114	27	41	182
Poisoning . . . . .	21	77	98	22	34	154
Medical accident. . . . .	40	31	71	11	9	91
All other . . . . .	225	249	474	151	187	812
<b>Total fatalities . . . . .</b>	<b>838</b>	<b>2,814</b>	<b>3,652</b>	<b>1,915</b>	<b>2,283</b>	<b>7,850</b>

<sup>a</sup>Does not include smothering.

SOURCE National Center for Health Statistics, Public Health Service, U S Department of Health and Human Services, unpublished data on accidental fatalities among children, 1987

emergency treatments annually are due to childhood injuries. Approximately **4,700** children under age 17 experience bed-disabling injuries<sup>4</sup> each year (705).

Childhood accidents are very costly to society, even after the tremendous social and emotional costs of death and disability are excluded. NCHS estimated that in **1980**, injury and poisonings (accidental and nonaccidental) accounted for 13.3 percent of acute medical care costs for children under age 17, or nearly \$2 billion (**479**). Accidental injuries probably account for most of this cost, which does not include long-term care costs or nonmedical costs.

A detailed study of accidental and other injuries among Massachusetts children aged **0 to 19** estimated that in 1982, the annual direct cost of injuries for their hospital and emergency care alone was **\$81.6 million (39)**. This figure implies annual hospital and emergency care costs of **\$48** per child (in 1982 dollars). Physician and non-hospital acute medical care costs were not included in the study. For the approximately **67 million** children aged **0 to 19** in the United States in 1982, \$48 per year would translate into over \$3.2 billion per year (in 1982 dollars).

Roughly 90 percent of the injuries in the Massachusetts study were accidental.<sup>5</sup> Applying this percentage to the above NCHS and Massachusetts cost figures for all injuries suggests that national acute care medical costs for accidental injuries would be an estimated \$1.8 to \$2.88 billion (in 1982 dollars). These figures do not include all acute costs and are several years old. A better rough approximation of the present national acute medical costs of accidental injuries in children, therefore, is **\$2 to \$3.2 billion** each year. If long-term care costs were included, the estimated costs of accidental injuries would be substantially greater.

<sup>4</sup>A bed-disabling injury is defined as an injury resulting in at least one day during which a person must stay in bed.

<sup>5</sup>Rough preliminary estimates suggest that approximately 2 to 3 percent of emergency room visits for injury and 10 to 15 percent of hospitalizations were due to assaults and self-inflicted injuries (38). The extent of misrecording the cause of injury is unknown, but it seems reasonable to assume that 90 percent of all emergency room and hospital inpatient costs incurred by injured children stemmed from accidental injuries.

## Causes of Accidental Injuries in Children of Different Ages

As table 7-1 suggests, particular types of accidental deaths tend to cluster in specific age groups. Death from choking, for example, is most common in infancy. Deaths due to poisonings, falls, and drownings are most common in preschoolers (ages 1 to 4). Deaths from firearms and explosives are rare in very young children (under age 5), but are the third leading cause of accidental death in older children (ages **10 to 14**). Motor-vehicle-related deaths are fairly constant across age groups under age 15, but the injured party varies considerably across groups. Most infants killed in motor vehicle collisions are occupants of the vehicle, whereas preschoolers killed in such collisions are likely to be pedestrians hit by an automobile, and older schoolchildren are often bicyclists.

The clustering of accident types in different age groups reflects the fact that rates of specific kinds of accidents depend substantially on a child's stage of growth and development (**527**). Infants and toddlers are particularly susceptible to household accidents associated with their increasing motor development and drive to explore the environment. In contrast, accidental injuries in teenagers over age 15 (a topic not addressed in this chapter) are often correlated with risk-taking behavior, such as participation in contact sports and unsafe driving practices. Boys have consistently higher rates of accidental injuries than girls (**41,527**), but researchers have generally resisted speculating on the reason for this difference.

## Social and Economic Differences in Accident Rates

Social and economic differences in accident rates also exist. One study of infant morbidity found, for example, that infants with very young mothers had significantly higher accident rates than infants with older mothers (**635**). In general, persons with lower incomes have higher injury-related mortality rates than wealthier persons (**527**), perhaps in part because lower income people may lack the necessary education or resources to modify their home and neighborhood environ-



ments. One study found that fire-related deaths in urban children were particularly strongly correlated with income (757). Low incomes are also sometimes associated with isolated rural populations that may be exposed to greater than average hazards (farm machinery, poor roads, high-speed travel) and a lack of quick emergency response (527). A few particular types of accidents (e.g., deaths due to drowning in private swimming pools) are more likely to occur in wealthier populations than in lower income populations.

### Injury Epidemiology and the Identification of Countermeasures

The epidemiology of injuries' has been approached in a manner similar to that used to characterize acute infectious diseases (527). In the case of an infectious disease (e. g., malaria), a disease-producing agent (e.g., a malarial parasite) is transmitted by a vehicle (e. g., a mosquito) to a person (or other host), who then becomes infected. Similarly, in the case of an injury, the agent of the injury is transmitted by some vehicle to a person, who then becomes injured. The "agent" of an injury is some form of energy, such as heat or mechanical energy. (Drowning or other forms of asphyxiation are caused by too little energy, rather than by too much. ) The "vehicle" may be a cigarette (causing a fire), a car, the water in a swimming pool, a poisonous household cleaner, or gravity (the vehicle for a fall).

<sup>1</sup>Injury epidemiology attempts to describe the characteristics of injuries and the factors that contribute to them.

Injury epidemiology focuses on the full range of factors affecting the injury before, while, and after the injury happened that could have prevented it or reduced its severity. Once these specific factors have been identified, they may suggest interventions that can be employed before, during, or after an event. A matrix such as that shown in table 7-2 can be used to show potential targets for intervention (239).

In identifying interventions to reduce accidental childhood injuries, surveillance research—i.e., research into how specific injuries are clustered in time and space—is a potentially useful tool. In the case of child pedestrian injuries, for example, surveillance research could investigate where and when the injuries most frequently occurred; what the children were doing when they were injured; the characteristics and conditions of the automobiles involved; the actions and conditions of the drivers; and the medical response and treatment available after the injuries occurred. The results of such research might even suggest the areas most susceptible to intervention (e. g., a specific intersection near a school where placing a crossing guard could reduce injuries).

Countermeasures are usually based on considerably less information than that illustrated in this example. Lack of detailed surveillance data hinders both the identification of a cluster of accidental injuries and the evaluation of an intervention to decrease the number of such injuries (58).

In a slightly different approach to identifying interventions, Haddon identified 10 general coun-

**Table 7-2.—Preventing Motor. Vehicle/Child. Pedestrian Injuries: Potential Targets for Accident Intervention**

Phases	Targets for intervention		
	Human factors	Vehicle factors <sup>a</sup>	Environmental factors
Before an accident . . . .	Hazardous activity, such as playing in traffic	Braking capacity of vehicles; condition of brakes	Parked vehicles and other obstructing objects
During an accident . . . .	Conditions of children that might increase trauma damage (e.g., hemophilia)	Sharp objects and edges on front of car; high bumpers	Hard road surfaces and other objects; street designs that increase exposure to vehicles
After an accident . . . . .	First-aid abilities of bystanders	Property damage (irrelevant to injury)	Rapidity of response and adequacy of emergency medical system

<sup>a</sup>The term "vehicle factors" in this matrix refers to a vehicle in the sense of an agent of transmission rather than a mode of transportation. See discussion in text.

SOURCE Office of Technology Assessment, 1988, based on a background paper by L. S. Robertson, "Childhood Injuries: Knowledge and Strategies for Prevention," prepared for Office of Technology Assessment, U. S. Congress, Washington, DC, February 1987.

countermeasures applicable to a variety of hazards, whether physical, chemical, or biological (238). Table 7-3 lists these general countermeasures and specific examples of countermeasures applicable to two types of accidental injuries. All 10 general countermeasures may not be applicable to every injury type, but a systematic review of each may suggest countermeasures that are potentially more effective or efficient than traditional measures. Various authors have used Haddon's conceptualization of countermeasures to suggest numerous options for a wide variety of injuries (136, 167,240,424,533,535,618 ).

Although a general conceptual analysis such as Haddon's is useful for identifying potential inter-

ventions, it cannot be used to estimate the relative necessity, effectiveness, cost, or feasibility of undertaking any particular option. In an area where most drownings occur in rivers or oceans, requiring fencing around private pools, for example, is likely to have little effect on drowning deaths. Similarly, if most children who drown know how to swim, increasing swimming education may be a relatively ineffective strategy. Furthermore, without adequate research on the effect of such training, there is no guarantee that the training will not increase the total amount of swimming and actually increase the number of deaths. It is in answering these questions that surveillance research and other research on the effectiveness of various options find their utility.

**Table 7-3.—General Countermeasures to Hazards: Examples of Their Application to Two Specific Hazards**

General countermeasure	Examples of countermeasures to address specific hazards	
	Example 1: Preventing drowning and submersion injury	Example 2: Preventing medication Poisoning in small children
1. Prevent creation (or accumulation) of hazard	Prohibit private, unsupervised swimming pools	Reduce use of drugs: get rid of old medications
2. Reduce amount of hazard	Reduce the number or permitted depth of private, unsupervised pools	Prescribe or package less medication per bottle
3. Prevent the release of the existing hazard	Teach all children to swim	Discourage medications in homes with small children
4. Modify the release of the hazard	Place sensors in dams and levees to signal appropriate release of water	Use coating on tablets to delay absorption; allow time for treatment
5. Separate hazard in time and space from those to be protected	Place playgrounds at a distance from streams, lakes, or pools	Keep medications in high or locked cabinet
6. Place physical barrier between hazard and those to be protected	Fence swimming pools; fence playgrounds near streams, lakes, or pools	Use child-resistant packaging
7. Modify relevant basic qualities of the hazard	Not applicable—water is not modifiable in any acceptable way	Make tablets too large for children to swallow; make liquids very unpalatable
8. Make that which is to be protected more resistant to the hazard	Encourage children to exercise to increase lung capacity	Educate children regarding dangers of medications
9. Begin to counter the damage already done by the hazard	Place underwater lights in pools; train lifeguards and parents in resuscitation	Educate the public regarding use of keeping ipecac and activated charcoal in every home
10. Stabilize, repair, and rehabilitate the object of the damage	Improve treatment and rehabilitation services to near-drowning victims	Train emergency personnel in poison identification and treatment techniques

SOURCES Modified from W Haddon, Jr., "On The Escape of Tigers An Ecologic Note," *Technology Review* 72:44, 1970, L S Robertson "Childhood Injuries Knowledge and Strategies for Prevention," paper prepared for Office of Technology Assessment, U S Congress, Washington DC, February 1987 and P Steele and D A Spyker "Poisonings" *Ped Clin N Am* 32(1) 77-86 1985

## EFFECTIVENESS OF PREVENTION STRATEGIES

There are three broad *strategies* for preventing accidental injuries in children:

1. **Persuasion/education:** persuading people to increase their self-protection (e. g., through education or reminders to use seatbelts).
2. **Regulation of behavior:** requiring people to increase their self-protection (e. g., by passing laws requiring the use of seatbelts).
3. **Automatic protection:** providing automatic protection from injury through product or environmental design (e.g., by designing automobiles so that a person is automatically seatbelted when in the vehicle) (451,531).

In terms of the matrix in table 7-2, all of these strategies focus on the period either before or during an accident, rather than after an accident.<sup>7</sup> In general, the first two strategies target human factors for intervention and are usually implemented at the State or local level. The strategy of automatic protection, on the other hand, generally targets “vehicle” (i. e., transmission agent) factors or large-scale environmental factors and can often be implemented nationally.<sup>8</sup>

The following discussion examines the effectiveness of these three general strategies in the context of specific *interventions* to prevent selected kinds of childhood injuries. An intervention, as used here, is a way of increasing the use of a preventive technology (e.g., a media campaign to increase smoke detector use, or the establishment of an agency to regulate potentially injurious products). Assessing the comparative effectiveness of alternative strategies depends on the effectiveness of the particular interventions. Such assessment is complicated by the fact that the interventions themselves vary in effectiveness, and by the fact that different strategies (e.g., education and regulation) may be combined in one intervention (e.g., a program that both teaches peo-

ple how to install smoke detectors and requires their installation).

*The critical outcomes of an intervention are the number of accidental injuries prevented and changes in the severity of such injuries.* But many evaluations of accident prevention programs are not designed to capture these outcomes (or cannot attribute the outcome to the intervention). The necessary data may not be obtainable or may be prohibitively expensive; or, the target population for the intervention may be so small that effects on injuries cannot be detected or attributed to the intervention with any statistical significance (58). Consequently, many studies report intermediate outcomes (e.g., the installation of a safety device).

The problem of attributing critical outcomes to the intervention employed is particularly acute for educational interventions. Figure 7-1 illustrates the effect of a public education program for preventing burns if two-thirds of the population at each step in the education process went on to the next step. Not all of those in the target population are exposed to the educational messages, and not all of those who are exposed actually comprehend the messages. Even smaller numbers of people change their behavior. The ultimate effect of the program in reducing injuries would be expected to be very small; it might be undetectable even if the study were designed to measure it.

### Persuasion/Education

Persuasion as a strategy to prevent childhood accidents is the historical cornerstone of injury prevention, but its success varies and is widely debated. Although educational programs can be relatively inexpensive and do not typically encounter the political resistance that regulatory programs often do, they tend to have only modest effects at best. One major educational program for older teens—driver education in public schools—has actually increased the incidence of accidental injury (539).<sup>9</sup> This experience suggests that sim-

<sup>7</sup>Postevent environmental factors that can reduce the severity of injury (e. g., rapid trained emergency response ) are not included in the preventive strategies discussed here.

<sup>8</sup>Classification of interventions into three general preventive strategies is a useful way to think about interventions, but, of course, a particular intervention may borrow from two or even all three strategies. For example, a landlord could be required by law to change a tenant’s environment,

<sup>9</sup>In Connecticut, when a driver education program was dropped from nine school districts following the elimination of State funding for the program, licensure and crashes of 16- and 17-year-olds in those nine districts, unlike districts that maintained the program

**Figure 7-1.—Attenuation of the Effect of a Public Education Program**

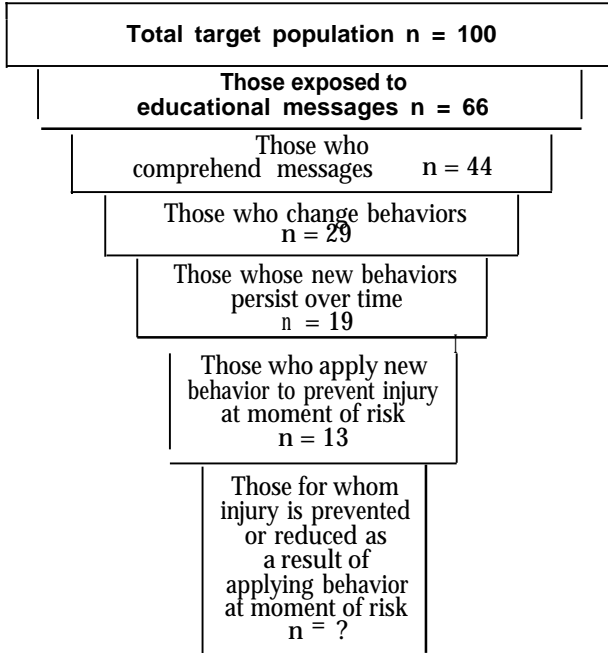

SOURCE Adapted from E McLoughlin, C.J. Vince, A M Lee, et al , Project Burn Prevent Ion Outcome and Implications, " American Journal of Public Health 72(3) 241-247, 1982

ilar educational programs for younger children (e.g., swimming lessons) may not reduce injuries if education results in increased exposure to a hazard.

The effectiveness of persuasion as a strategy often depends on the frequency of the behavior that one is attempting to change. In general, the more frequent the behavior that people must change in order to protect themselves or their children and the greater the effort required to change it, the less effective will be programs to persuade them to do so (41,531).

### Motor-Vehicle-Related Injuries

Before laws were passed requiring the use of child restraints in automobiles, several programs sought to increase voluntary use of this preven-

through local funding, declined precipitously (532). A Canadian study found that motor vehicle crash rates of teenage drivers were much more strongly correlated with age than with driver education and experience. Newly licensed 18-year-olds had roughly the same crash rates as 18-year-olds with 2 years of driving experience. both groups of 18-year-olds had much lower crash rates than newly licensed 16-year-olds (535).

tive technology. Two studies showed some success. One, a controlled study of pediatric practices, found a modest short-term increase in the use of child restraints among families whose pediatricians prescribed the restraints and demonstrated their proper use (523). In a second study, mothers of newborns who were randomly selected to receive a free child restraint used the restraints more than both mothers who were given only educational materials and those given neither information nor free restraints (522). The improvement was modest, about a 7- to 8-percent increase in use compared to the control group.

Attempts to reduce child pedestrian injuries have generally focused on teaching children appropriate pedestrian behavior (or to avoid crossing streets altogether) (235). Although some studies of these interventions indicate that children acquire pedestrian skills easily (774), others are more cautious. One such study used model cars and roads to teach children pedestrian skills. After training, less than half the children remembered to look for turning cars, and a substantial number of children (half the 6-year-olds and 25 percent of 9-year-olds) did not remember to stay in the crosswalk. On the positive side, an education program in three cities resulted in a 20- to 30-percent reduction in child pedestrian injuries involving children darting into the street (509). This program used film and television spots to teach children to stop and look for moving vehicles.

### Fire-Related Injuries

The wide variation in outcomes that can result from different persuasive strategies is well demonstrated by programs to prevent fire-related injuries (although presumably other factors entered into the outcomes as well). In one experimental program, pediatricians counseled families regarding the importance of smoke detectors. The counseled group increased the proportion of correctly installed detectors by 41 percent, while the uncounseled control group did not change behavior (429). In Missouri, a community awareness program using media, school, and group presentations succeeded in decreasing burn deaths by an apparent 43 percent (although probably not all of the decrease was due to the education program)

(197). A community awareness program in two Massachusetts communities, on the other hand, increased self-reported knowledge of preventive actions but had no detectable effect on the number of burns (416).

A Baltimore, Maryland, program to increase smoke detector use gave free detectors to people who requested them. In a study of 231 people randomly selected from among the 3,720 recipients, investigators found that 92 percent of their detectors were actually installed, and 88 percent were operating correctly 4 to 9 months later (217). Furthermore, the recipients were highly concentrated in areas of the city with the greatest fire-injury rates.

### **Other Home Injuries**

Many injuries, particularly to very young children, occur at home. But "safety-proofing" homes has proved difficult to do (134). The fact that an educator may be trying to change many behaviors and environmental factors simultaneously (e. g., storage of hazardous products; use of window locks; lowering of water heater settings) may contribute to reduced impact of the message and a lower probability of compliance (134).

In one program aimed at reducing home injuries associated with 10 categories of household items, a prepaid health plan furnished parents with information regarding appropriate use and storage of these hazardous items at the time of a pediatric health care visit (135). In a followup telephone call, parents claimed to have made many of the items inaccessible to children. An on-site inspection of homes, however, showed no difference in access to hazardous items compared to access in a control group of families who had received no information.

In contrast, a Massachusetts home inspection program that used family counseling at the time of a sanitary code inspection to educate parents, with the inspectors actually installing some safety devices themselves, showed significant improvements in reduction of household hazards in the inspected homes when compared with homes in a control group (191).

Pediatricians are a common source of safety education for parents, although most pediatricians

actually spend little time in injury prevention counseling (521). An American Academy of Pediatrics program known as TIPP (The Injury Prevention Program) encourages pediatricians to educate parents about accident prevention by providing the physician with a schedule for introducing injury topics to families and with materials on these topics suitable for general distribution.

When pediatric counseling is extensive, it can sometimes have an effect. In a group of families where parents were given written materials regarding falls, were counseled by a pediatrician, and were exposed to reminders at each visit, falls occurred in 10 percent of infants during the subsequent year compared to 17 percent in a comparison group that did not receive the messages (355). In another study, families who were counseled by pediatricians regarding six categories of household hazards had significantly fewer hazards apparent at followup than families in a control group (51).

Poison information centers are a longstanding and effective intervention to prevent serious injury (100,178). Their primary purpose is to reduce the severity of poisoning injury by providing information and assistance to parents after a suspected poisoning. Educating parents regarding the use of these centers has been shown to decrease inappropriate use of hospital emergency rooms (100).

### **Regulation of Behavior**

If changes in behavior are effective in preventing injuries, but education is only partially successful in changing behavior, then *requiring* behavioral change may be more effective. Many accident problems, however, are not well suited to a regulatory strategy (e.g., proper storage of household poisons). And since the essence of the regulatory approach is that people's voluntary choices may be contrary to the ideals of public health, regulation of behavior raises issues regarding the relative importance of individual freedom v. public health and public dollars. Still, regulating behavior has been very effective in increasing the use of several technologies, most notably child restraints in automobiles and smoke detectors.

The effect of laws and administrative rules, like the effect of persuasion, depends to some degree

on the frequency of the required behavior. Also important are the public observability of the behavior, the degree to which the behavior is sanctioned by the community, and the ability to enforce the law.

### Motor-Vehicle-Related Injuries

The gradual implementation of individual State laws requiring infant safety restraints in automobiles has provided an opportunity to compare behavior in those States, before and after the laws were implemented, with behavior in States without such laws. Tennessee was the first State to pass such a law (in 1977); it required all children under the age of 4 in parent-owned automobiles to be restrained in an infant or child seat unless they were traveling in an adult's lap. (This exception to the law was later removed.) In the first 3 years after Tennessee's law was implemented, restraint use by children under the age of 4 increased from 8 to 28 percent (753). Fatalities to children in this age group declined by about 50 percent between 1978 and 1983, in parallel with increased enforcement of the law (130). The decrease in fatalities was greater than expected given the observed increase in use of restraints, so factors other than the use of restraints were probably at work as well.

By 1984, all 50 States had enacted laws requiring the use of safety restraints for children in automobiles (29). Several States have, like Tennessee, reported impressive increases in the use of child restraints and decreases in child mortality following implementation of the laws (231,577, 753).<sup>10</sup> No national estimate of injury reduction due to the cumulative effect of child safety restraint laws is available. Undoubtedly, however, these laws contributed to the 36-percent decline in motor vehicle occupant deaths among children under age 5 between 1980 and 1984 (234,713).

Whether as a result of laws or increased consumer awareness, observed use of child safety restraints in automobiles in the United States has increased substantially over the past few years. The National Highway Traffic Safety Administration (NHTSA) reports that use of restraints

<sup>10</sup>Again, some of the decrease in mortality may be due to factors other than restraint laws (3)

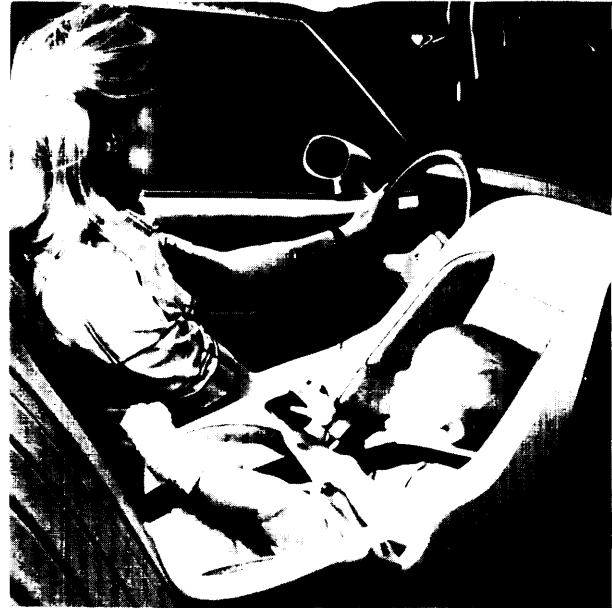

Photo credit: American Association for Automotive Medicine

Infant seats have contributed to substantial reductions in motor-vehicle-related injuries to children,

among children under age 5 more than tripled between 1981 and 1986—from 22.8 percent in 1981 to 75.8 percent in 1986, based on a 19-city observational survey. Furthermore, the percentage of young children who were correctly restrained increased from 17 to 67 percent of all observed children during this period. Engineering improvements that have made child safety restraints easier to use may have contributed to the increase in correctly used restraints (29).

Still, there is considerable room for improving child safety restraint laws. As shown in table 7-4, many States require safety restraints in automobiles only for very young children. Altogether, 38 States have no restraint requirements for children over age 5 (and many States do not require restraints for children over 3 or 4) (719). Most other States have general seatbelt laws that require persons other than very young children to be restrained; a few States do not require seatbelts for adults but do require older children to wear them (719). Laws covering only certain ages and exempting certain vehicles may fail to prevent a substantial number of avoidable deaths. One analysis of motor vehicle occupant fatalities in very

Table 7-4.—Comparison of Child Safety Restraint Laws in 50 States and the District of Columbia, June 1987

State	Year effective	Age required to be restrained	Age required to be in safety seat	Existence of general belt law covering older children?	Selected comments
Alabama	1982	Under 3	Under 3	No	—
Alaska	1985	Under 6	Under 4	No	—
Arizona	1983	Through 4	Through 4	No	a,b,d
Arkansas	1983	Under 5	Under 3	No	—
California	1983	Under 4	Under 4	Yes	a,b
Colorado	1984	Under 4	Under 4	Yes	b
Connecticut	1982	Under 4	Under 4	Yes	—
Delaware	1982	Under 4	Under 4	No	a
District of Columbia	1983	Under 6	Under 3	Yes	—
Florida	1983	Under 6	Under 4	Yes	d
Georgia	1984	Under 4	Under 3	No	—
Hawaii	1983	Under 4	Under 3	Yes	—
Idaho	1985	Under 4	Under 4	Yes	a,b
Illinois	1983	Under 6	Under 4	Yes	a,d
Indiana	1984	Under 5	Under 3	Yes	—
Iowa	1985	Under 6	Under 3	Yes	d
Kansas	1982	Under 4	Under 4	Yes	a,c,d
Kentucky	1982	Under 40"	Under 40"	No	a,b
Louisiana	1984	Under 5	Under 5	Yes	—
Maine	1983	Under 12	Under 4	No	a,d
Maryland	1984	Under 5	Under 3	Yes	—
Massachusetts	1982	Under 12	Under 5	No	d
Michigan	1982	Through 4	Through 4	Yes	—
Minnesota	1983	Under 4	Under 4	Yes	d
Mississippi	1983	Under 2	Under 2	No	—
Missouri	1984	Under 4	Under 4	Yes	—
Montana	1984	Under 4	Under 2	Yes	a,b,d
Nebraska	1983	Under 4	Under 1	No	—
Nevada	1983	Under 5	Under 5	Yes	—
New Hampshire	1983	Under 5	Under 5	No	d
New Jersey	1983	Under 5	Under 5	Yes	—
New Mexico	1983	Under 11	Under 5	Yes	d
New York	1982	Under 10	Under 4	Yes	d
North Carolina	1982	Under 6	Under 3	Yes	d
North Dakota	1984	Through 5	Under 3	No	d
Ohio	1983	Under 4	Under 4	Yes	b
Oklahoma	1983	Under 5	Under 4	Yes	d
Oregon	1984	Under 16	Under 1	Yes	d
Pennsylvania	1984	Under 4	Under 4	No	—
Rhode Island	1980	Through 12	Through 3	No	d
South Carolina	1983	Under 4	Under 4	No	—
South Dakota	1984	Under 5	Under 2	No	d
Tennessee	1978	Under 4	Under 4	Yes	d
Texas	1984	Under 4	Under 2	Yes	—
Utah	1984	Under 5	Under 2	Yes	a
Vermont	1984	Under 5	Under 5	No	d
Virginia	1983	Under 4	Under 3	Yes	d
Washington	1984	Under 5	Under 1	Yes	—
West Virginia	1981	Under 9	Under 3	No	d
Wisconsin	1982	Under 4	Under 2	No	d
Wyoming	1985	Under 3	Under 3	No	b

## KEY TO COMMENTS

- a—Law applies only to parents and legal guardians.  
b—Restraint required for child of specified age or less than 40 pounds.  
c—Kansas law applies only to children riding in the front seat  
d—State has upgraded its original child restraint law This table reflects those revisions

SOURCE US Department of Transportation National Traffic and Highway Safety Administration, unpublished data on child restraint laws. Washington, DC, June 1987 and July 1, 1987

young children (ages 0 to 5) concluded that in some States, up to 43 percent of deaths occurred in children who would not have been covered under restraint laws as of 1984 (636).

The evidence regarding the role of enforcement in improving the effectiveness of restraint use is somewhat conflicting. A few studies of specific enforcement efforts have found that such efforts had little additional effect (535). However, one study of seatbelt use found that Texas had the highest rate of compliance in the Nation, a rate which Texas authorities attributed to vigorous enforcement efforts (518).

### Fire-Related Injuries

The presence of a properly installed and functioning smoke detector is associated with large reductions in the number of deaths from residential fires (415). A national survey found that the proportion of households with smoke detectors increased from 22 percent in 1977, to 46 percent in 1980, to 67 percent in 1982 (722). In specific cases, legislation requiring the installation of smoke detectors in private residences has been associated with decreased deaths. In Montgomery County, Maryland, where smoke detectors are required by law in all residences, the number of working detectors is greater (and the number of residences without detectors smaller) than in nearby (and demographically similar) Fairfax County, Virginia, which does not have such a law. Furthermore, after the law was enacted, fire deaths declined more rapidly in Montgomery County than in Fairfax County (415).

### Other Injuries

Regulation has proved successful in preventing drownings associated with children entering unsupervised swimming pools. The annual pool-associated fatality rate in Honolulu, Hawaii, where fences and childproof gates around pools are required, is approximately one-third that of Brisbane, Australia, which has a similar climate and pool-to-household ratio but no fencing requirement (480).

Bicycle helmets have been proposed as a potential new target for regulation. In 1984, 344 young children died from collisions between

motor vehicles and pedal cycles (bicycles and tricycles) (see table 7-1). In addition, an estimated **582,000** emergency room visits by children were attributable to bicycle-related injuries in 1985 (667). Approximately 14 percent of motor-vehicle/bicycle collisions result in head injuries to the cyclist (190). These figures imply that the use of bicycle helmets might substantially reduce severe injury resulting from bicycle falls and collisions, although valid studies of the relationship between helmet use and bicycle-related injuries do not exist. Helmet use is uncommon among children. An Arizona study found that less than 2 percent of Tucson children commuting to school by bicycle wear helmets (745). To OTA's knowledge, the use of bicycle helmets is not required in any State or municipality in the United States.

It is difficult to separate the effectiveness of regulation alone from the effectiveness of the accompanying education and enforcement. A conscious combination of the three applied to a specific problem, however, can be extremely effective. Box 7-A describes the successful application in New York of a combined strategy to reduce fatal injuries from falls out of windows.

### Automatic Protection

Providing automatic protection avoids the need for individuals to alter their behavior; it requires only a one-time change that does not depend on altering behavior. An airbag installed in an automobile, for example, does not require the individual to "buckle-up" every time he or she gets in the automobile. Automatic protection can be brought about not only by regulating products but also by eliminating hazards in the environment (e. g., dangerous intersections). The design of automobiles, children's products, and medication packages are areas where automatic protection has been widely and successfully implemented to reduce injuries.

For automatic protection to be successful, the manufacturers and producers of potential hazards must be aware of and use technical strategies to reduce the hazardous characteristics of the products. In some cases, a private entity or the government itself can reduce a hazard through environmental changes, such as by providing better



**Box 7-A.—Example of a Successful Strategy To Prevent Fatal Childhood Injuries From Falls**

An effort by the New York City Health Department illustrates the effect that can be obtained by combining good surveillance research, a simple and effective preventive technology, and an intervention that combines persuasive and regulatory strategies. An investigation of 201 fatal falls, conducted between 1965 and 1969, revealed that 61 percent of fatal falls in children under age 15 and 85 percent of those in children under age 5 were falls out of windows. Furthermore, 96 percent of the fatal falls occurred in three of the five boroughs of the city (Bronx, Brooklyn, and Manhattan).

The most feasible technical approach to addressing this problem was identified as the installation of barriers over windows. A campaign was launched in high-risk neighborhoods to persuade parents or landlords to install such barriers (607). Eventually, the Health Department issued regulations requiring landlords to install the barriers whenever they were asked to by tenants. The number of children's deaths due to fatal falls from windows declined dramatically as a result—from 30 to 60 per year in the mid-1960s to 4 in 1980 (55).

After a while, as families moved and children were born in new families, the number of fatal falls from windows increased. In July 1986, the city changed the regulation. It now requires landlords to install barriers in windows in buildings where there are children under age 11, regardless of whether a parent has requested the barrier.

street lighting or installing a traffic signal. Reduction of hazards associated with private products can sometimes be accomplished without regulation if consumers are discriminating enough to choose items that are safer (and sometimes if they are willing to pay more as well). Where such voluntary changes are insufficient, government regulation may be employed to force all manufacturers to meet some standard of safety. Uniform regulation can ensure that producers who want to make their products safer are not placed at a competitive disadvantage when safety features increase production costs, and that consumers need not (or cannot) trade off safety and cost.

## Motor-Vehicle-Related Injuries

Attempts to reduce automobile injuries have included both product and environmental changes. The Motor Vehicle Safety Act of 1966 (Public Law 89-563) required automakers to include certain safety features in 1968 and subsequent model cars.<sup>1</sup> Automobile safety regulations are administered by NHTSA.

Estimates of the effects of these standards, based on comparison of fatalities associated with vehicles to which the standards did or did not apply, indicate approximately 15,000 fewer deaths per year (in all age groups) in the early 1980s than would have occurred without the standards (536). Some of the continued reductions in automobile-associated deaths observed in the 1980s can probably be attributed to the continued attrition of old vehicles that did not meet the standards. The effect of the standards on death rates of children alone has not been estimated.

Automatic restraints (airbags or automatic seatbelts) are a current area of controversy among industry, consumer groups, and government. Such restraints are now provided in a few car models and are currently scheduled to become mandatory by 1990 unless at least two-thirds of the U.S. population resides in States with mandatory seatbelt use by that time.

Other possibilities for improvement also remain. For example, many vehicles still have protrusions such as knobs and tapered dashboards that can cause injury to the faces, heads, and chests of individuals during crashes or sudden braking (752). One study found that 12 percent of children's injuries in motor vehicles occurred in noncrash braking or swerving (4).

Street and highway improvement can also significantly affect vehicle-associated deaths in all age groups—adults as well as children. For example, deaths due to crashes at railroad crossings de-

<sup>1</sup>The safety features included shoulder belts, energy-absorbing steering assemblies, interior padding, seat integrity, and side running lights, among others. Subsequent standards were imposed for hoodlatch, brake fluids, and head restraints (1969); child seating systems and power-operated windows (1971); retread tires and flammability of interior materials (1972); side door and roof strength (1973); one-piece lap and shoulder belts (1974); rear-end fuel system integrity and windshield zone intrusion (1976); and, most recently, eye-level brake lights (1986).

clined by 52 percent between 1974 and 1984, at least in part as a result of railroad crossing improvements brought about by the Highway Safety Act of 1973 (133). Vehicle-associated deaths can be further reduced by such measures as improved road-striping and installation of energy-absorbing materials at selective roadside sites where crashes are likely to occur (357,766,767). Better street design in areas of high-density housing holds potential for reducing the number of child pedestrian deaths (235,528). Federal grants to the States for road construction and site modification to reduce crash incidence and severity are administered by the Federal Highway Administration.

Changes in right-turn-on-red laws and speed reduction are two examples of legal interventions that have been suggested to decrease motor-vehicle-related injuries. A study of motor vehicle accidents after the implementation of right-turn-on-red laws found that the number of child pedestrian injuries was 30-percent higher after the laws were in place, and that most of the increase took place in urban areas (778).

Speed reduction, through enforced speed limits or limited top speed capacity in automobiles, has been widely cited as a way to decrease fatalities (444,535). Recent legislation (Public Law 100-17) permits States to raise speed limits on rural highways to 65 mph. There is evidence that rural areas had higher automobile fatality rates than other areas even before this legislation (43). Future studies can evaluate whether higher legal speed limits in these areas further increase fatality rates.

### **Injuries From Toys and Other Consumer Products**

Toys and other products intended for use by children are subject to voluntary product safety design (by manufacturers) and to consumer product regulation administered by CPSC. That Commission was created in 1972 (Public Law 92-573) and has the authority to promulgate mandatory safety standards for any consumer product that poses an “unreasonable risk” of injury or illness. (The Commission does not have jurisdiction over foods, drugs, tobacco products, firearms, boats, aircraft, or motor vehicles. ) In extreme cases, CPSC can ban products from the market (15 U.S. C. 2052).

The statutes that are administered by CPSC contain wording directing particular attention to products used by children, making this organization the Federal agency most directly involved in regulating children’s products. Bicycles, for example, were one of the first major products for which CPSC developed standards (241 ). The Commission tested 277 toys and children’s products with suspected hazards during fiscal year 1985; 58 percent of the tested products failed to comply with CPSC standards.

The implementation of “childproof” caps on certain drugs and household chemicals is a major success story in product regulation’s effect on child safety. Child poisoning deaths from aspirin declined 80 percent between 1965 (the year that manufacturers voluntarily adopted container caps that were difficult for children to remove) and 1975 (137). The Poison Prevention Packaging Act of 1970 (Public Law 91-601) resulted in further packaging standards, implemented by CPSC between 1972 and 1980. Reported ingestions of the regulated products by children under age 5, measured from the year that a given product was regulated to 1983, declined from between 40 and 90 percent, depending on the product (668). Nonetheless, over 60,000 unintentional ingestions of prescription medications by children under age 5 were reported to poison control centers in 1985 (694). Household solvents, corrosives, and caustics continue to result in a child hospitalization rate of about 5 to 12 per 100,000 children each year for each category of product (645), or an estimated 3,000 to 7,500 children per product type.<sup>12</sup>

CPSC has been the subject of considerable recent controversy. During the 1980s, the Commission has emphasized voluntary rather than mandatory industry standards for unsafe products (622). It has been criticized not only for a lack of mandatory standards for what are perceived as substantial problems (538) but also for its use of cost-benefit calculations when considering product regulation (406) and for its alleged lax enforcement of existing standards (596).

<sup>12</sup>The Consumer Product Safety Commission (CPSC) is not the only Federal regulatory agency involved in the regulation of poisonous products. The Food and Drug Administration, for example, has promoted poison educational materials and has required warning labels on both prescription and over-the-counter drugs.

Recent products with which CPSC has been involved include proposed regulation of all-terrain vehicles and hot water heaters. In the former case, CPSC's own database has documented a dramatic rise in injuries, and the Commission is still debating the appropriate regulatory policy (407). In the case of hot water heaters, addressed by CPSC at

the time of a public petition, the Commission has chosen to rely on voluntary compliance of manufacturers to set temperature settings at levels sufficiently low to prevent scald burns (506). Two products associated with substantial numbers of injuries—cigarettes (causing fires) and firearms—are not within the jurisdiction of CPSC (538).

## THE COSTS OF ACCIDENT PREVENTION

There is very little published information on the costs of accident prevention programs to government agencies (e. g., a State health department) or to producers and consumers. What little cost information exists is largely in the area of Federal regulatory interventions, and it is very controversial.

One study of the effects of Federal regulation on automobile costs, for example, concluded that the cumulative costs of all safety regulations (after accounting for "learning curve" efficiencies) had added approximately \$491 to the cost of manufacturing an automobile (120). According to the researchers, approximately two-thirds of regulatory costs were eventually passed on to consumers (120). This study is considered by some critics to overestimate the costs of automobile regulation, because the source of the study's manufacturing cost data was manufacturers, who have incentives to make the costs of regulation appear high (537).<sup>13</sup>

In contrast to the automatic protection strategy that is the context of Federal regulation by NHTSA and CPSC, behavior-modifying strategies—education and regulation of behavior—tend to be implemented on the State or local level. Many of the costs of educational programs are often borne by State or local health departments. The great advantage of educational interventions is that they are rarely subject to political opposition. On the other hand, costs to individual families—monetary or nonmonetary—often limit

<sup>13</sup>Historically, for example, manufacturers have suggested that adding airbags to automobiles would increase consumer costs from \$290 to \$1,150 (738). Their own costs were estimated at \$135 to \$280 (1982 dollars). Some of the variation in estimates is due to estimates of the volume that would be produced. The large ranges and apparently high anticipated markups for these and other passive restraint systems, however, have suggested to some researchers that costs may be inflated in order to discourage regulation (462).

the effectiveness of educational interventions. The evidence on these interventions presented above tends to suggest that educational programs are more successful when the costs to the family are low or minimized through the provision to families of free safety devices.

Interventions that regulate behavioral change have many of the same costs and characteristics as educational interventions, partly because they still require the acquisition of a device or alteration of habitual behavior. They also usually involve education on some level, if only because the political process often includes attempts to persuade the public (as well as legislators) regarding the desirability (or undesirability) of the law. Passing a law tends to be more expensive if the law is controversial, and the factors that would make a requirement controversial can be the same barriers that might make an education-only intervention ineffective. For example, making bicycle helmets mandatory would probably be controversial, because it would require consumers to purchase helmets; to remember to use them each time they ride bicycles; to monitor helmet use in their children; and to give up the freedom of choice not to wear a helmet. Persuading people to wear helmets voluntarily might be difficult for all of the same reasons except the last.

Enforcement imposes an additional cost on regulatory interventions, but it may well be worth the expense because enforcement seems (at least sometimes) to be an important component of the increased effectiveness of regulation compared to education. Some of the costs of enforcement can be recovered through fines, but imposing a fine merely transfers the cost from the enforcement agency to the fine payer.

Sometimes the costs of adherence to regulations can be very great to consumers. For example, the use of infant seat restraints could be required on commercial aircraft just as it is in automobiles, but the costs of such an intervention might be more than simply the inconvenience and the cost of the restraint. Infants are often permitted by commercial airlines to travel free if they ride on the lap of an adult. An intervention that required parents to use restraints for their infants, therefore, would also require them to purchase an additional ticket (unless the airline had a policy requiring ticket purchase only if the flight were full). Parents might perceive such a requirement as entailing a much greater cost than benefit, particularly if the marginal increase in safety is low.

In summary, most interventions to reduce accidental injuries in children involve some costs—some monetary, some nonmonetary—borne either by governments or directly by people. The nonmonetary costs of compliance with regulations, for example, may lead consumers not to fully comply unless enforcement is rigorous and sanctions are high. Although some nonmonetary costs of compliance can be reduced through education that alters dangerous habitual behavior, successful education programs can also be costly. A full accounting of the costs of specific accident prevention interventions to all parties (not just the program costs) would enhance the development of more cost-effective interventions.

## FEDERAL AGENCIES INVOLVED IN PREVENTION EFFORTS

After a quiescent period, the Federal Government has shown renewed interest in injury prevention during the past few years. In addition to the ongoing efforts of NHTSA and CPSC in motor vehicle and consumer product regulation, there is now significant effort in several agencies toward developing better surveillance systems, promoting research into accident causes and prevention, and assisting States in the implementation of accident prevention programs. Some of the activities of NHTSA, the Centers for Disease Control (CDC), and other Federal agencies in these areas are summarized in box 7-B.

For the most part, the different Federal agencies involved in funding specific programs and projects have different foci. NHTSA has been particularly involved in child restraint projects. CDC, with a recent increase in funding, is providing grants for a wide variety of demonstration and research projects and for three research centers;

these grants include prevention of injuries in all age groups. CDC has also taken the lead in coordinating surveillance efforts. The Division of Maternal and Child Health of the Public Health Service funds demonstration projects on injuries in children and provides program implementation assistance. The National Institute for Child Health and Human Development is focusing on background research into accidental injury.

Most injury demonstration programs are oriented, at least initially, at preventing accidental injuries through behavior modification and are implemented at the State or local level. The local approach is a logical one for many types of accidents. The local environment may contribute to accidents (e. g., high-density housing and child pedestrian accidents), and prevention programs may need to be tailored to local social characteristics.

### Box 7-B.—Federal Injury Prevention Assistance

The Federal Government's primary involvement in the prevention of accidental childhood injuries occurs through the regulation of motor vehicles by the National Highway Traffic Safety Administration (NHTSA) and the regulation of certain consumer products by the Consumer Product Safety Commission (CPSC). In the past few years, however, as a result of increased interest and increased funding, there has been a substantial increase in Federal agencies' support of State and local accidental injury prevention activities. Some of the injury prevention assistance activities by NHTSA and other Federal agencies are outlined below.

**National Highway Traffic Safety Administration (U.S. Department of Transportation) .—In 1985, NHTSA distributed \$15.8 million** in grant money to States for use in child safety restraint programs (538). NHTSA grant money is also used to fund more general activities, such as alcohol countermeasures, emergency medical services, bus driver programs, and pedestrian safety programs,

A 1985 National Academy of Sciences report, *Injury in America* (451), heightened congressional interest in the prevention of injuries, and in 1986, Congress appropriated \$10 million to NHTSA to carry out the recommendations of that report. One of these recommendations was that the Centers for Disease Control (CDC) coordinate Federal injury prevention efforts. Consequently, NHTSA transferred nearly all of this special appropriation to CDC. The language surrounding the appropriation specified that at least half of the money was to be targeted to motor-vehicle-related injury, so NHTSA has worked together with CDC in decisions regarding that funding (29).

**Centers for Disease Control (Public Health Service) .—During the 1970s and early 1980s, CDC awarded small contracts to States and other entities to develop injury control strategies for persons in all age groups. (CDC awarded a total of approximately \$765,000 during this period (538), ) In 1985, CDC increased the number of staff committed to accidental injury prevention projects from 3 to 14 people (566). In early 1986, CDC received the nearly \$10 million in injury prevention funds from NHTSA described above, and the agency consolidated staff from the intentional and unintentional injury divisions. With the \$7.8 million of this money allocated to extramural research, CDC has funded 5 injury research centers and 32 individual research project grants (566).**

**Division of Maternal and Child Health (Public Health Service) .—The Division of Maternal and Child Health funds demonstration projects on various topics, one of which is accidental injury prevention. Until 1986, this agency was the most significant source of Federal funding for projects to prevent non-motor-vehicle-related injuries in children. In fiscal year 1986, the Division of Maternal and Child Health spent just over \$1.5 million of approximately \$71.7 million in total grant funding on prevention of accidental injuries in children (about 8.5 percent of grant funds) (268). Grant topics during fiscal year 1986 included statewide injury prevention programs in Massachusetts, North Carolina, and Wisconsin, and a six-State New England cooperative injury prevention network (697). In fiscal year 1987, the Division of Maternal and Child Health is providing a small amount of additional funding to support the implementation of ongoing injury prevention programs in eight States (268).**

In addition to providing grants, the Division of Maternal and Child Health has produced a guide for States on implementing accidental injury prevention programs. The Division is also joining with NHTSA and CDC in funding a National Commission on Injury Prevention whose mission is to aid States in designing injury prevention programs.

**National Institute for Child Health and Human Development (NICHD) (National Institutes of Health). —NICHD has only recently begun to devote substantial resources to injury research. The Institute held a workshop on accidental injury research needs in September 1986, and it has since funded two projects on injury research methods at a cost of \$450,000 (564).**

NICHD is now in the process of funding injury research, with the intention of focusing on basic mechanisms of injury, NICHD is also providing some funding to support enhanced injury data collection during the upcoming 1988 Child Health Supplement to the National Health Interview Survey (564).

## CONCLUSIONS

Although both numbers and rates of childhood deaths due to injuries have declined, injuries remain the leading cause of death and hospitalization for children over the age of 1. The vast majority of injuries in children are accidental. This fact suggests that there is merit in giving prevention of accidental childhood injuries a high priority in the maintenance of children's health.

The United States has clearly made some progress toward reducing accidental injury fatalities in children—and presumably nonfatal childhood injuries as well. Between 1975 and 1984, the country achieved a 33-percent reduction in accidental fatalities among children under age 15. The decline in deaths from motor-vehicle-related injury is a particularly important part of this achievement, accounting for one-third of the reduction—approximately 1,400 lives saved in 1984 alone (534,713).

Despite this progress, we are still remarkably ignorant about many important facets of injury prevention and program implementation. For instance, very little is known about the costs of alternative preventive interventions (the most startling fact about these costs is that they are almost never discussed). Similarly, although there is good evidence for the effectiveness of specific interventions, there has been little study of the underlying reasons why one educational intervention is effective and another is not; of the marginal benefits of additional preventive technologies or interventions; and of the relative costs and effectiveness of alternative strategies.

This lack of information results in decisionmaking that may be more guess than calculation. How much does it cost to give out free smoke detectors? How much does an educational program to encourage their use cost? What about the costs of requiring their installation and enforcing the regulation with inspections? Which is more effective? Would requiring sprinklers be more effective than requiring smoke detectors? At what cost? What are the marginal costs and benefits to requiring sprinklers in addition to smoke detectors? How much education is needed to make either technology fully effective?

Automatic protection is probably the most effective preventive injury strategy in most instances, because it requires no behavioral change on the part of the consumer. Automatic protection often allows the end users to make a one-time purchase (e.g., an automobile equipped with airbags) but to receive a certain amount of constant protection. The per-unit costs will tend to decline if all products include the protection, and production efficiencies result. Many motor vehicle-related injuries can be prevented by measures amenable to Federal and State regulation, and indeed, such injuries have declined dramatically in parallel with regulatory efforts. Product regulation has likewise been an effective preventive measure. In some cases, however, improved automatic protection may have increasing marginal costs for each increment of added protection.

Strategies that require people to change their behavior, occasionally or habitually, have been generally considered less effective than automatic protection. Regulation of behavior, which can be enforced, is considered by most researchers to be a more effective method of increasing safety-enhancing behavior than merely educating people regarding dangers and appropriate behaviors. Neither education nor regulation is a one-time cost; both require ongoing investments (into re-education, enforcement, or both).

Still, it is difficult to discount education as an important strategy to combat accidental injuries. The literature suggests that the educator, the audience, and the existence of additional incentives are all variables that can affect the success of educational efforts to prevent injury. The disappointing results of many persuasive programs are not failures to communicate: many such programs do increase knowledge regarding dangers. Rather, these programs are relatively ineffective because they often encourage changes in frequent or habitual behavior (behavior considered inconvenient by the parent or child). Education may be an important component of regulatory strategies, both in encouraging the legislative process and as a necessary background to acceptance and proper use of required technologies (177).

Rivara has suggested that 12 currently known or available preventive interventions could, if universally applied, reduce childhood deaths due to injuries by 29 percent (528):

- infant seat restraints in automobiles,
- air bags for front seat motor vehicle occupants,
- helmets for motorcyclists,
- helmets for bicyclists,
- expansion and enforcement of the Poison Prevention Packaging Act,
- barriers around swimming pools,
- self-extinguishing cigarettes,
- smoke detectors,
- elimination of handguns,
- knowledge of the Heimlich maneuver,
- adherence to CPSC regulations, and
- window bars in windows above the first floor.

Other observers have promoted more widespread or mandatory application of such interventions as:

- hot water heater temperatures of no more than 120 degrees Fahrenheit,
- stringent limits on the sales and use of all-terrain vehicles
- “no-right-turn-on-red” laws,
- prohibitions on radar detectors,
- maximum speed limits to car performance, and other extensions of automobile or consumer product safety (538).

Rivara’s estimates of effectiveness rates are limited by the existence of only a few sound evaluations of these interventions. The estimates thus tend to be optimistic. Also, some of these interventions involve additional costs to society or substantial loss of personal choice, issues that need to be taken into account when considering accident prevention policies. Nonetheless, this list of currently available interventions illustrates that progress in accident prevention need not wait.

---

Chapter 8

# Prevention of Child Maltreatment



# CONTENTS

	<i>Page</i>
<b>Introduction</b> . . . . .	<b>167</b>
<b>Defining Child Abuse and Neglect</b> . . . . .	<b>167</b>
Physical Abuse . . . . .	168
Physical Neglect . . . . .	168
Psychological Abuse. . . . .	168
Psychological Neglect. . . . .	168
Sexual Abuse... . . . .	169
<b>Estimated Incidence and Prevalence of Child Maltreatment</b> .... .	<b>169</b>
Estimates Based on Official Reports of Maltreatment . . . . .	169
Estimates Based on Cases of Maltreatment Known to Professionals.. . . .	170
Estimates of Parent-to-Child Violence Based on Household Surveys . . . . .	171
Estimates of Child Sexual Abuse.... . . . .	171
False Reports of Child Maltreatment. . . . .	172
<b>The Causes of Child Maltreatment</b> . . . . .	<b>172</b>
Theories About the Causes of Child Maltreatment . . . . .	172
Child-Related Risk Factors for Maltreatment. . . . .	173
Parental Risk Factors for Maltreatment . . . . .	173
Risk Factors for Child Sexual Abuse.... . . . .	176
<b>The Effects of Child Maltreatment</b> . . . . .	<b>177</b>
The Effects of Child Abuse and Neglect on Maltreated Children . . . . .	177
Financial Costs Attributable to Child Maltreatment . . . . .	178
<b>Effectiveness of Preventive Strategies and Programs</b> . . . . .	<b>179</b>
Effectiveness of 19 Federally Funded Clinical Demonstration Projects . . . . .	179
Effectiveness of Five Home Health Visitor Programs . . . . .	180
<b>Federal and State Funding for the Prevention of Child Maltreatment</b> . . . . .	<b>184</b>
<b>Conclusions</b> . . . . .	<b>185</b>

## Tables

<i>Table No.</i>	<i>Page</i>
<b>8-1. Estimated Rates of Parent-to-Child Violence in U.S. Households, 1985....</b>	<b>171</b>
<b>8-2. Commonly Studied Risk Factors for Child Maltreatment . . . . .</b>	<b>179</b>
<b>8-3. NCCAN Funding for State and Discretionary Grants,     Fiscal Years 1981-86 . . . . .</b>	<b>185</b>

# Prevention of Child Maltreatment<sup>1</sup>

---

## INTRODUCTION

In the two decades since the publication of an influential article entitled "The Battered Child Syndrome" (322), there has been an explosion of concern in professional and lay media with the problem of child maltreatment. The early 1970s brought revisions in the laws mandating the reporting of and broadening the definition of child abuse. The National Center on Child Abuse and Neglect (NCCAN) was established as part of the U.S. Department of Health and Human Services by the Child Abuse Prevention and Treatment Act (Public Law 93-247) in 1974, and in the past decade, it has become the focal point within the Federal Government for addressing the problem of child maltreatment.

Despite concern with the problem, however, reported cases of child maltreatment in this country have increased markedly. Between 1976 and 1985, reports of child maltreatment increased by 180 percent (657). In 1985, 1.9 million cases of child maltreatment were reported to child protective services agencies (657).

## DEFINING CHILD ABUSE AND NEGLECT

Only a modest consensus regarding the definitions of child abuse and neglect exists in the United States. Different States, professional disciplines, and public agencies have defined these phenomena in varying ways (205). All 50 States and the District of Columbia have laws defining child maltreatment and mandating that professionals working with children report suspected cases. Typically, however, the laws are rather vague, leaving a good deal open to interpretation. In general, professionals agree that an act by a parent or caretaker constitutes maltreatment if it involves

This chapter considers several aspects of the problem of child maltreatment. It examines, in turn:

- the definitions of child abuse and neglect,
- estimates of the incidence and prevalence of child maltreatment,
- the causes of child maltreatment,
- the effects of child maltreatment,
- the effectiveness of strategies intended to prevent child maltreatment, and
- Federal and State funding for the prevention of child maltreatment.

In considering the effectiveness of preventive strategies, the focus of the chapter is not on the activities of child protective services agencies that work in conjunction with the legal system to prevent reoccurrences of child maltreatment. (These agencies may also seek to treat the consequences of maltreatment, an important topic outside the purview of this report.) Rather, the focus of this chapter is primarily on innovative preventive programs that could augment the traditional child welfare/legal system.

direct harm or intent to injure, including intentionality without physical injury (e. g., locking a child in a dark closet).

Different forms of child abuse and neglect are frequently categorized in the following groupings:

- physical abuse,
- physical neglect,
- psychological abuse,
- psychological neglect, and
- sexual abuse.

Generally speaking, child abuse implies an act of *commission* that harms a child, child neglect an act of *omission* that harms a child. Beyond that, the way these terms are defined frequently

<sup>1</sup>This chapter is based on a background paper entitled "Child Maltreatment in the United States: Etiology, Impact, and Prevention," prepared for OTA by H. Dubowitz (143).

varies, depending in large measure on who is defining the terms and for what purpose.

### Physical Abuse

Physical abuse is the infliction of physical injuries, although some definitions also include violence that is potentially injurious. Cigarette burns, inflicted fractures, and belt marks are unambiguous examples of physical abuse.

Some individuals use less stringent definitions of physical abuse than others. A pediatrician, for example, might consider corporal punishment of a child to be physically abusive and therefore decide to counsel the child's parents about other disciplinary strategies. A social worker for a State child protective service agency, on the other hand, might require scattered bruising to substantiate a case report. A district attorney interested in prosecuting an abusive parent would probably become involved only if a child sustained serious bodily injuries.

### Physical Neglect

Physical neglect involves the failure to meet a child's fundamental needs (e. g., needs for appropriate nutrition and clothing) or noncompliance with critical medical care. According to one observer, "Leaving an infant in a crib, without changing his diapers and without giving him any contact or stimulation, represents both physical and emotional deprivation: the infant will probably have rashes and sores and might well be developmentally delayed" (65).

Although professionals and lay persons differ in their definition of optimal child rearing, they generally agree when defining inadequate care (499). In some cases—for example, in homeless families—a child may lack some fundamental necessities despite the efforts of the child's parents. Cases such as this, in which it is difficult to assign culpability to individuals, are typically not construed as abuse or neglect.

### Psychological Abuse

Psychological abuse consists of parental behavior that is thought to damage the child's emotional and psychological well-being (192,319). Ex-

amples of a psychologically abusing parent are a rejecting parent who repeatedly communicates his or her angry feelings toward a child or a parent who places inappropriately high expectations and demands on a child.

Again, the definition of psychological abuse depends on the purpose of those defining it. Child mental health professionals might consider certain caretaking behaviors to be abuse if those behaviors damage the optimal psychological development of a child. Child protection agencies, on the other hand, would typically require that a deleterious impact on a child be demonstrated *and* be attributable to the abusive behavior before the case is substantiated. A causal relationship is usually very difficult to prove. Consequently, psychologically abused children who receive attention from child protection agencies tend to represent flagrant cases, often involving other forms of abuse and neglect.

### Psychological Neglect

A lack of attention to the important psychological needs of a child constitutes psychological neglect (750). An infant who is upset might require the affection and attention of a parent or caregiver for comfort; a parent who provides affection appropriately fosters a sense of security and trust in the infant. But if a mother is suffering from postpartum depression, for instance, she may have difficulty responding to her baby's cues. As a result of psychological neglect, her infant may withdraw and feed poorly, eventually developing the syndrome known as "failure to thrive."

Before they will substantiate a case of psychological neglect, child protection agencies typically require, as they do in the case of psychological abuse, that a child exhibit behavior or health problems attributable to deficiencies in care. Child protection agencies' operational definition of neglect is only *partly* based on whether a child's needs are not being attended to as measured against accepted community standards. Generally, these agencies become involved only in cases of psychological neglect that are severe or that involve other forms of maltreatment in addition to psychological neglect.

## Sexual Abuse

Researchers, clinicians, and the legal system have defined sexual abuse in varying ways. The researchers Finkelhor and Araji defined it as “sexual contact that occurs to a child as a result of force, threat, deceit, while unconscious, or through exploitation of an authority relationship, no matter what the age of the partner” (172). Another researcher, Russell, defines sexual abuse broadly to include behavior that does not involve physical contact (556).

Clinicians generally apply somewhat different criteria in defining sexual abuse. Although there seems to be agreement that when physical force and contact are involved in a sexualized manner, sexual abuse has occurred, Finkelhor’s and Araji’s broad definition of sexual abuse is difficult to apply in the clinical setting. Furthermore, at least

in adolescents, evaluating whether a sexual experience has been “unwanted” can be difficult, although some researchers argue that there is little justification for applying different standards to adolescents (769). Sexual abuse that does not involve physical contact is seldom reported to health professionals, aside from rare situations where overt symptoms are apparent and the child or family seek assistance.

Child protective services agencies generally accept as cases only more severe cases of sexual abuse and tend to ignore the vast majority of cases of noncontact sexual abuse. The legal system applies the strictest criteria, generally focusing on those cases where physical signs of sexual abuse are evident.

## ESTIMATED INCIDENCE AND PREVALENCE OF CHILD MALTREATMENT<sup>2</sup>

Estimating the incidence and prevalence of child maltreatment with any precision is very difficult. Estimates vary depending on whether they are based on official reports of child maltreatment to child protective services agencies, on cases known to professionals who deal with abused and neglected children, or on household surveys. Furthermore, the estimates based on these sources are probably too low, but how much too low is hard to say.

### Estimates Based on Official Reports of Maltreatment

Each year since 1974, the American Association for Protecting Children (AAPC) has estimated the incidence of child abuse and neglect on

the basis of official reports of child maltreatment to State child protective services agencies nationwide (23,24). Although not all States and jurisdictions contribute data on individual cases, AAPC surveys all States for information on total number of reports, data sources, and characteristics of the reporting systems. Other recent data on reported child abuse and neglect are available from a national survey conducted by the House Select Committee on Children, Youth, and Families in the 50 States and the District of Columbia (657).

Even as assessments of the reported incidence of child abuse and neglect, the AAPC and House Select Committee studies have several limitations. First, different States use different definitions of child abuse; some States, for example, do not report emotional abuse. Second, some States report maltreatment by the number of families reported; hence, a conversion factor must be used to obtain an estimate of the number of reported children. Third, reports by most States are not an unduplicated count of children; hence, an increase in the number of reports may represent either an

<sup>2</sup>**Incidence** is the frequency of new occurrences of a disease or condition within a defined time interval in a defined population. The incidence rate is the number of new cases of a specified disease or condition divided by the number of people in a population over a specified period of time, usually 1 year. **Prevalence** is the frequency of existing cases of a disease or condition within a defined time interval in a defined population. The prevalence rate is the number of existing cases of a disease or other condition in a defined population at a particular time or over a specified time period.

increase in the number of children or additional reports for the same number or even fewer children. Fourth, States differ in the degree to which reports are substantiated (i. e., investigated and the abuse or neglect confirmed); in 1985, the substantiation rate ranged from a high of 67 percent in Oregon to a low of 25 percent in Iowa and Virginia (657). Fifth, States differ in the degree to which total reports represent all referrals; most States have some screening prior to reporting. Sixth, many States have not collected data by type of maltreatment; thus, for example, data to compare the reported incidence of sexual abuse, physical injury, and neglect are available from only 19 less-populated States for the entire period from 1981 to 1985 (657).

Despite their limitations, the following estimates from AAPC and the House Select Committee on Children, Youth, and Families are presented as key estimates of reported incidence of child maltreatment in the United States (24,657):

- In 1985, an estimated 1.9 million child maltreatment reports were made in the United States, a rate of 30.2 reports per 1,000 children under 18 years of age (assuming no multiple reports per child).
- Between 1976 and 1985, the number of reports of child maltreatment in the United States increased by 180 percent, despite a slight decline in the total child population. Between 1984 and 1985, the number of reports increased 9 percent.
- Reports of sexual abuse increased more than reports of other categories of child maltreatment. Among the 34 States providing complete information for the period, reports of sexual abuse of children increased 23.6 percent from 1984 to 1985; by comparison, reports of physical abuse and neglect of children increased 6.6 percent and 5.0 percent, respectively.

More recent but less complete State data on reported child maltreatment are available from a survey of State reports for 1986 (448). In 1986, according to preliminary estimates projected from data in 34 reporting States (representing 62 percent of all children), there were 2 million reports of child maltreatment nationwide, an increase of

approximately 6 percent over the number of reports recorded during 1985.

In the 34 reporting States in 1986, the survey found 727 reports of children's deaths due to maltreatment (448). This figure represents an increase of 37 percent over the number of deaths reported in 1984 (448). If nonreporting States had the same rate of deaths as reporting States in 1986, child maltreatment caused at least 1,200 children's deaths nationwide that year.

Actually, the number of children's deaths due to maltreatment in 1986 is probably far in excess of the estimate of 1,200 derived from official reports. Estimating the actual number, however, is inherently difficult for two reasons. One is that children's deaths may be coded as due to a variety of causes, and it is often difficult to determine that a given death is due to maltreatment, particularly in cases involving infant deaths and in cases of possible neglect. Second, there is evidence that the number of fatal child abuse cases reported to child protective services is much below the number suggested both by law enforcement data (717) and vital statistics child homicide data (300, 302).

### **Estimates Based on Cases of Maltreatment Known to Professionals**

In an effort to improve on estimates of child maltreatment based solely on officially reported incidents, NCCAN sponsored a national study on the incidence and severity of child abuse and neglect to count the number of cases of child abuse and neglect known to professionals during a 1-year period (677). The NCCAN study used a stratified random sample of 26 counties. Data were obtained from the professional staff of child protective services agencies, as well as from the staff of other agencies throughout each county—local police departments, county public health departments, public schools, short-stay hospitals, and mental health facilities. These professionals were asked to identify any possible cases of child maltreatment known to them, using very clear guidelines to identify behavior as maltreatment. A final determination on whether child maltreatment had actually occurred was made by the NCCAN investigators.

For the United States as a whole, the NCCAN investigators estimated, a total of 1.2 million cases of child abuse and neglect were suspected by professionals for the year May 1979 through April 1980. About 652,000 of these suspected cases met the strict criteria developed by the study as constituting maltreatment.<sup>3</sup> Perhaps the most important finding of the NCCAN study, however, was that only one-third of the cases of maltreatment known to professionals were reported to child protection agencies (677).

### Estimates of Parent-to-Child Violence Based on Household Surveys

Using a household survey to estimate the incidence of parent-to-child violence within families, Straus and Genes estimated in 1985 that 10.7 percent of children in U.S. households experienced severe acts of violence and 1.9 percent experienced very severe violence (625). The Straus and Genes study was based on a national probability sample of 1,428 households with two adults and at least one child. Each household was surveyed by telephone. Respondents were asked to reflect on the past year and to indicate how conflicts between family members were resolved. The instrument used in the Straus and Genes study was the Conflict Tactics Scale, a reasonably valid and reliable instrument for measuring family violence. The scale provides a list of strategies ranging from “discussing the problem” to “using a gun or a knife” and thus allows an assessment of the degree of reasoning, verbal aggression, and physical aggression used in resolving conflicts. The results of the study with regard to rates of parent-to-child violence in U.S. households are presented in table 8-1.

The Straus and Genes study has several limitations. First, the data were based on self-reports of respondents to anonymous telephone interviews; social pressures may have led some individuals to deny their violent behavior, thereby resulting in an underestimate of the incidence of violence. Second, the study included only children between 3 and 17 years of age who were liv-

<sup>3</sup>In most cases of physical neglect, for example, the study definitions required evidence of serious injury or impairment; in contrast, it would be hoped that most child protective services agencies would not require this degree of severity before they intervened.

**Table 8-1.—Estimated Rates of Parent-to-Child Violence in U.S. Households, 1985<sup>a</sup>**

Type of violence	Rate per 1,000 children age 3-17
Minor acts of violence:	
1. Threw something . . . . .	27
2. Pushed, grabbed, shoved. . . . .	307
3. Slapped or spanked . . . . .	549
Severe acts of violence:	
4. Kicked, bit, hit with fist . . . . .	13
5. Hit, tried to hit with something . . . . .	97
6. Beat up . . . . .	6
7. Threatened with gun or knife . . . . .	2
8. Used gun or knife . . . . .	2
Violence indices:	
Overall violence (1-8). . . . .	620
Severe violence (4-8) . . . . .	107
Very severe violence (4, 6, 8). . . . .	19

<sup>a</sup>For two-caretaker households with at least one child 3 to 17 years of age at home

SOURCE M A Straus and R J Genes, “Societal Change and Change in Family Violence From 1975 to 1985 as Revealed by Two National Surveys,” *Journal of Marriage and Family*, 48:465-479, 1986. Copyright (1986) by The National Council of Family Relations, Fairview Community School Center, 1910 West County Road B, Suite 147 Roseville, MN 55113

ing with two adults over the age of 18. Because it excluded two important groups of children at high-risk for maltreatment—namely, children under age 3 and children living with a single parent—the study probably underestimates the incidence of parent-to-child violence.

In 1975, Straus, Genes, and Steinmetz had conducted a household survey similar to the one just mentioned (626). A comparison of the two surveys indicated that while the overall level of violence remained stable in the 1975-85 period, the amount of severe and very severe violence decreased substantially. From 1975 to 1985, the rate of very severe parent-to-child violence declined from 36 to 19 incidents per 1,000 children. This decline cannot be attributed to methodological differences between the two surveys. Rather, the decline is probably due to the combination of an increase in reluctance to report severe violence and real changes in behavior (624). Although the decrease in severe violence is encouraging, an extremely high level of violence against children persists. The authors estimate that 1.5 million children aged 0 to 17 in two-parent families were subject to very severe violence in 1984 (624).

### Estimates of Child Sexual Abuse

Sexual abuse appears to be the fastest growing component of reported child abuse, rising from

a rate of 0.09 reports per 1,000 children in 1976 to 1.6 reports per 1,000 children in 1984 (657).

More useful estimates are from studies of the prevalence of child sexual abuse. Such studies survey adults about their childhood sexual experiences. Reported prevalence rates range from 6 to 62 percent throughout childhood for girls and from 3 to 31 percent for boys (172). Using a very conservative childhood sexual abuse prevalence rate of 5 percent obtained from various community surveys, Finkelhor and Hotaling (173) estimate that something on the order of 150,000 to 200,000 new cases of child sexual abuse occur each year.

### **False Reports of Child Maltreatment**

Social workers screen out or fail to substantiate approximately 58 percent of case reports of child abuse and neglect (24). Clear evidence of maltreatment may be lacking either because no maltreatment occurred or because an investigation was too limited to uncover it. In general, child protective services staff are undertrained and overwhelmed; while attempting to meet great demands with inadequate resources, they raise their thresholds for accepting cases. Although some reports of child maltreatment are certainly made when no maltreatment has occurred, there also seems little doubt that some cases screened out or not substantiated by child protective services are, in fact, cases of maltreatment.

On the other side of this issue is the possibility of increasing rates of falsely reported child abuse,

particularly sexual abuse (308). Some have claimed that a number of false allegations are made in the context of divorce. A recent survey of domestic relations courts conducted by the Association of Family and Conciliation Courts and the American Bar Association found that the courts are encountering a small but growing number of sexual abuse allegations. Nevertheless, "the number of sexual abuse charges arising during divorce and/or custody/visitation disputes is small in absolute number and as a percentage of all contested cases" (641). A study of suspected child abuse cases reported in Denver between 1983 and 1985 found that only 6 percent of alleged sexual abuse cases were based on deliberately false reports (308). Thus, false reports are not likely to be affecting the trends in reporting to any great extent.

The problem of a small number of false or fictitious reports of child maltreatment should be counterbalanced by what is probably a much greater number of cases that remain secret within the family and are never brought to the attention of professionals. Clinicians have found that sexual abuse victims frequently delay disclosure of their abuse for substantial periods, and many probably never reveal their painful pasts. Given the privacy of the family, it is inherently difficult to determine that an event (i.e., an act of child abuse) has occurred (267). This situation makes it particularly difficult to measure the success of maltreatment prevention programs.

## **THE CAUSES OF CHILD MALTREATMENT**

Identifying the causes of child maltreatment is difficult. Various theories have been used to account for the problem, and various risk factors have been studied by researchers. As the following discussion indicates, however, for many of the factors often thought of as contributing causes of child maltreatment, the supporting evidence is either absent, minimal, or inconsistent.

### **Theories About the Causes of Child Maltreatment**

The researchers who first began to address the problem of child abuse focused on the psycho-

pathological traits of the child-abusing parent (188,421,617). In some sense, this focus seems reasonable. One expects that no normal person would deliberately hurt a child; hence, any person who does abuse children must suffer from some kind of mental illness.

Other theories have also been utilized to explain child abuse, including social learning theory, cognitive development theory, and environmental stress theory. Social learning theory posits that child abuse is learned behavior. Children who have experienced abusive and violent childhoods transfer this "learning" to their families of desti-

nation. Cognitive development theory suggests that many caretakers of children simply have not learned what constitutes normal child development, reasonable expectations for children, and what parental responses are appropriate. Environmental stress theory emphasizes that child abuse results from stressful life conditions and events outside the individual, including poverty, unemployment, social isolation, and a violent environment (459).

Each of these theories is consistent with one or more of the many factors that are viewed as contributing to child abuse and neglect. Table 8-2 identifies a number of risk factors commonly studied by researchers in the field. No single theory (or set of related risk factors), however, seems to explain the diversity of maltreating families and their circumstances. The risk factors for one kind

of abuse may be quite different from the risk factors for other types of abuse. Sexual abuse, in particular, stems from different factors. Consequently, sexual abuse is discussed in a separate section below.

Much of our current understanding of child maltreatment is based on data from identified cases. To the extent that these cases fail to reflect the true phenomenon or only one part of it, this “knowledge” is a misrepresentation. As shown below, a comparison of risk factors for child maltreatment derived from different data sources illustrates that many of these factors are artifacts of the reporting system. Much of the research is exploratory and descriptive, and many of the studies use design methods that have major deficiencies (498).

**Table 8-2.—Commonly Studied Risk Factors for Child Maltreatment<sup>a</sup>**

<b>Individual-level risk factors:</b>
Age of child
Perinatal problems
Child's health status
The “difficult” child
Age of parent
Parent's history of abuse as a child
Parental intelligence
Parental psychopathology
Parental awareness
Parental perceptions of their child
Parental knowledge of child development
Disciplinary strategies used by parents
<b>Family -level risk factors:</b>
Stress
Single parenthood
Number of children
Spacing of children
Living conditions
Substance abuse
Family supports
A new baby
Other family violence and relationships
<b>Community-level risk factors:</b>
Community impoverishment
Social isolation
<b>Societal-level risk factors:</b>
Ethnicity
Attitudes toward violence
Attitudes toward children
Poverty
Unemployment

<sup>a</sup>Sexual abuse excluded

SOURCE Adapted from H. Dubowitz, “Child Maltreatment in the United States: Etiology, Impact and Prevention,” prepared for the Office of Technology Assessment, U.S. Congress, Washington, DC, October 1986.

## Child-Related Risk Factors for Maltreatment

An extensive review of research studies indicates that a child's characteristics do not predict child maltreatment (143). In fact, observed correlations between characteristics of the child and maltreatment may reflect the results of maltreatment rather than its causes.

It does appear true, however, that very young children are especially vulnerable to severe physical abuse. AAPC's report on official child neglect and abuse reports in 1984 indicated the following average ages: 7.3 years for all maltreated children; 5.3 years for children with major physical injuries; 8.1 years for emotionally maltreated children (24). AAPC's report for the year 1983 found that 64 percent of abused children with major physical injuries and 37 percent with minor ones were under 6 years of age (23). Similarly, Straus, Genes, and Steinmetz's household survey of how families resolved conflicts found that substantial physical force was most likely to be used against children under age 5 or against 15- to 17-year-olds (626).

## Parental Risk Factors for Maltreatment

AAPC has consistently reported that the average age of perpetrators of child maltreatment is about 31 years (24)—a figure that implies that



many maltreating parents are older parents, not just teenage mothers. A study in Georgia found that teenage motherhood was a risk factor for being reported—i.e., a factor that contributed to greater surveillance—but not additional risk for child abuse (299).

There appears to be little support for the hypothesis that abusive parents are less intelligent than other parents, despite its intuitive appeal (613). Studies of parental perceptions of their children as well as parental knowledge of child development have yielded mixed or contradictory results (143). If there is any relationship between intelligence and maltreatment, it is probably with neglect rather than abuse (148,613).

The data concerning drug and alcohol abuse in child-abusing parents and their families remain ambiguous. Some studies have reported an association (44), while others have failed to find any difference between abusing and nonabusing parents in their drug or alcohol use (11,291). These conflicting findings might be explained by the differences in the assessment measures used. Clinical experience suggests that alcohol and drug abuse is an important factor in domestic violence. It is presumably difficult for the alcoholic or heroin-addicted parent to care for a child adequately. Child neglect, if not abuse, must be a frequent concern.

Some researchers have suggested that the birth of a new baby is an important source of potential stress, since family members need to adjust (335,471). Many prevention programs have focused on this early period to support families (222,588). The failure to establish early rapport between parent and child, i.e., poor parent-infant bonding, has been suggested as a contributor to subsequent maltreatment (180). Experts have suggested that newborns who are separated from their parents, and children who are not securely attached to their parent, are at risk for maltreatment (180,200). Olds and Henderson recently completed a review of controlled studies of this topic (470). Although the results of the studies were not entirely consistent, the reviewers concluded that it is unrealistic to expect a few extra minutes or hours of contact between high-risk parents and their newborns to substantially alter the

reactions to stressful life circumstances over the succeeding years (470).

It now appears that while the “bonding issue” made a valuable contribution toward humanizing obstetric care, its critical importance has been overstated. There are other opportunities for attachment to develop, and a problem with early bonding is at most likely to be a modest contributor to subsequent maltreatment (586).

With respect to race and ethnicity, studies based on reports of maltreatment made to child protective services agencies have shown the ethnic minorities, the less educated, and the poor to be overrepresented (203,299). A study that only considered substantiated cases of child maltreatment found that blacks had the highest rates, followed by Mexican-Americans and whites (365). This result was supported by a secondary analysis of the same data that controlled for social class and community characteristics.

A number of studies have documented that minority groups and the poor are susceptible to being labeled as maltreaters, largely because of professional stereotypes and bias (199,466). Straus, Genes, and Steinmetz’s national household survey of family violence (626) found little difference between black and white families in self-reported rates of violence.

Four other parental factors are often mentioned as possible risk factors for child maltreatment: parental mental illness, single parenthood, history of abuse as a child, social isolation, and poverty and unemployment. Some of the evidence concerning each of these factors is presented below.

### **Parental Mental Illness**

Early work in the field of child maltreatment centered around parental mental illness, and several studies described the psychotic traits of child-abusing parents (88,421,617). Later work, however, showed that most abusive parents were not psychotic (608), and no single abusive psychological profile or pattern has been found to exist. Indeed, a British study of abusive parents found that only 1 in 10 had a definable psychiatric condition, a rate comparable to the rest of the population (595). A review of studies comparing abu-

sive and nonabusive parents did not find any differences in underlying personality attributes or traits “beyond general descriptions of displeasure in the parenting *role* and stress-related complaints” (761).

### Single Parenthood

In 1984, 37 percent of the families reported for child maltreatment—as compared with 23 percent of all U.S. families with children under age 18—had a single female as the head of the household (24). Several studies have identified single parenthood as a significant risk factor for child abuse (76,561). The problem with these studies, however, is that they failed to control for an obvious correlate of single-parent households—namely, poverty. It is likely that the mixed results of various studies are due to this uncontrolled factor. It is also likely that case reporting rates are higher for single parents because of biases in child protective services.

### Parental History of Abuse as a Child

The intergenerational transmission of child abuse has been the subject of a great deal of controversy. Generally, retrospective studies of the parents of children currently identified as abused have found a relatively high prevalence of parents who themselves had been abused as children (202,226). *No* comparison groups have been studied, however. Furthermore, the view that “violence begets violence” has been challenged by Gil and other researchers, who found that only 14 percent of mothers and 7 percent of fathers in identified maltreating families had a history of being abused (11,202,203).

Prospective studies that have examined the parenting practices of parents who were abused as children are more helpful. In a 25-year longitudinal study, Miller and Challas found that 45 percent of persons abused as children were rated as not abusing their own children; in contrast, 47 percent of persons who were not abused as children were found to have some potential for abuse (427). Another study found that over 80 percent of previously abused parents did not abuse their infants (291).

Straus has reported interesting differences in the transmission of violent behavior depending on the age at which the children (now parents) were physically punished, and by whom (623). He found that teenagers who were punished by their mothers were less abusive of their offspring than teenagers punished by their fathers. In addition, Straus noted:

. . . parents whose *fathers* hit them as teenagers have a child abuse rate which is one-third higher than parents who were under equally high stress that year, but who did not experience . . . violence directed against them as teenagers. The difference between the effect of having been hit by one’s mother versus by one’s father suggests that violence by the father against a teenage child is a more influential role model for violent behavior which the child will later display under stress (623).

Of course, some portion of what appears to be intergenerational transmission of violence may be due to the continuity of poverty from one generation to the next—i.e., extremely poor children are likely to head poor or near-poor families in the next generation. Hence, it is necessary to control for this third factor in both the family of origin and in the family of destination.

### Social Isolation

It is argued that social supports promote a sense of identity, self-esteem, and physical well-being and help the individual cope with stressful events (74). In this context, it is not surprising that isolation has been considered to be an important contributory factor to child maltreatment (193).

Various studies have found that social isolation and a lack of support networks play a role in maltreating families (152,467,614,731). The correlation of single parent status and high residential mobility with child maltreatment is often thought of as additional indirect evidence in support of the social isolation hypothesis. A recent critical review of studies found, however, that there was little evidence that lack of social support plays a significant role in the origins of physical abuse (575). That review indicated stronger evidence that lack of social support characterized parents who neglected their children, although it is diffi-

cult to tell whether the social isolation is a cause of the neglect or another manifestation of the poor psychological resources of these families.

### Poverty and Unemployment

In 1984, 48 percent of families reported to State agencies for child maltreatment were receiving public assistance (24). Numerous studies have shown that the poor and minority groups are treated differently from others by professionals working in the child abuse field, and that this bias is at least partly responsible for the increased identification and reporting of child maltreatment in poor families (254,318,466). The argument that follows from this position is that maltreatment is underreported in middle and upper classes, and that there is no true association between poverty and actual maltreatment, only an association with reported maltreatment.

Straus, et al.'s 1975 national survey of how conflicts were resolved in families that had not been identified as maltreating argues otherwise (626). A finding of that survey was that poorer families had the highest rates of violence. Poor families earning under \$6,000 a year reported twice as much violence as families earning over \$20,000. Still, there is the possibility that middle and upper income families were more reluctant than poor families to disclose their violent behavior.

In a Georgia study of confirmed fatal child abuse cases between 1975 and 1979, however, children receiving Aid to Families With Dependent Children (AFDC) were four times more likely to suffer fatal child abuse than children not receiving AFDC (301). Of the different forms of child maltreatment, neglect appears most strongly correlated with low socioeconomic status (206). In one study, 57 percent of the neglect group, compared to 19 to 27 percent of the other maltreating groups, relied on public assistance (582).

On balance, it seems reasonable to conclude that although some poor people are unfairly reported for maltreatment (and some middle and upper class families go undetected), there is an important association between poverty and child maltreatment (484). It is important to recognize, though, that most poor people do not abuse or neglect their children.

Economic factors other than poverty have also been found to be important. In a reanalysis of Gil's data, Light found unemployment to be the most powerful predictor of child maltreatment (381). A number of studies have documented an association between areas with high unemployment rates and an increased incidence in child maltreatment (112,195,196). These findings are supported by Steinberg, et al.'s longitudinal study, which tested whether undesirable economic change led to child maltreatment (620). In this study, analysis of data over a 30-month period revealed an increase in child abuse following periods of high job loss, and this finding was replicated in two metropolitan communities.

### Summary of Evidence on Parental Risk Factors for Child Maltreatment

**The most important parental risk factors for child maltreatment are those related to poverty and unemployment and a history of abuse as a child. Indeed, it may be that a history of being abused as a child is related in part to past poverty and unemployment.** Many of the other factors that are often thought of as contributing to child maltreatment—parent-child bonding, ethnicity, parental mental illness, and single parenthood—do not seem to be important factors, particularly when social class is controlled.

### Risk Factors for Child Sexual Abuse<sup>4</sup>

The causal underpinnings of sexual abuse are quite different from other forms of child maltreatment, although some overlap exists. Several interacting contributory factors are responsible, rather than single causes.

In an analysis of eight community-based random sample surveys, Finkelhor and Araji found that 71 percent of all respondents who said they were sexually abused as children were girls and 29 percent **were boys** (172). The median age of onset of abuse of girls was consistently between 10 and 11 years. When the risk for each year of age was calculated, a substantial increase occurred at 6 years with an estimated risk of 1.49 percent (i.e., 1.49 per 100 6-year-old girls are abused), and

<sup>4</sup>This section is largely derived from Finkelhor and Araji's recent book entitled *A Source Book on Child Sexual Abuse* (172).

again at age 10, with a risk of 3.76. For girls between 10 and 12 years of age, the risk of being victimized is more than double the average rate for all girls between 1 and 18 years.

Finkelhor and Araji's review lists several studies that reported an increased rate of sexual abuse among women who lived without their natural mothers or fathers at some time during childhood (171,490,557). Four of six studies found the presence of a nonbiologically related father to be a significant risk factor for abuse (170,230,557,763).

## THE EFFECTS OF CHILD MALTREATMENT

The effects of child maltreatment on children can be physically and emotionally devastating. Some of the direct effects of maltreatment on abused and neglected children are discussed below. Also discussed are some estimates of the societal costs for medical and foster care of maltreated children.

### Effects of Child Abuse and Neglect on Maltreated Children

There is no typical abused child. There is also no direct relationship between specific forms of child abuse and specific developmental outcomes, since an array of individual and environmental factors account for the varying effects of abuse on children. (Many followup studies of maltreated children have found that such children have an increased incidence of social and emotional problems, but it is often difficult to discern whether these problems preceded or resulted from the maltreatment.) Despite the variety of outcomes, however, the effects of abuse on maltreated children are generally negative.

Many maltreated children have no overt evidence of physical injury. For example, in 1984 three-quarters of reported children had no injuries (24). As medical expertise and sophistication in the field of child maltreatment increase, however, more subtle injuries are being diagnosed. This development is well illustrated by the application of new knowledge in the clinical detection of sexual abuse (157,606,764). Almost any trau-

matic physical injury—e.g., injuries to the eye, fracture of the teeth, and rupture of an intra-abdominal organ—can result from physical maltreatment (151). The most extreme outcome, of course, is death.

One study found that 2.3 percent of daughters growing up with biological fathers had been sexually abused by them, as compared to 17 percent of girls growing up with stepfathers (557). In addition, the nature of the abuse from stepfathers was more severe and more violent.

Social class probably is not a significant factor for sexual abuse (116,320,326). Studies have consistently found similar rates of sexual abuse for blacks and whites (326,490,677),

Neglect can also have deleterious medical effects. Neglected children have been found to have poorer medical care with more frequent lapses (e.g., in their immunizations) than children in a comparison group (228). Ingestions of poisonous substances have been associated with family dysfunction and lack of supervision (59,598). Some children who exhibit nonorganic failure to grow and develop as expected for their age and sex have been neglected by their parents.

Generally, bruises will fade, welts will resolve, burns and lacerations will heal. The most common and most important lasting effects of child maltreatment are often psychological. Although research on the psychological and developmental effects of maltreatment is sorely lacking (1), some studies of abused children indicate that they have more aggression and behavioral problems than children who have not been abused. Abused children often have an impaired ability to develop a sense of trust in others. Some of them develop cognitive deficits. Abused children frequently manifest a general air of depression, unhappiness, and sadness (143).

Among the psychological effects of child sexual abuse (i. e., outcomes manifesting within 2 years of the abuse) are anger, hostility, and sex-

ual problems (157,606,764). Most studies of the long-term effects indicate that depression is an important symptom among women who were molested as children. Other long-term effects include suicide attempts, sleep problems, diminished self-esteem, fear and hostility towards men and women, enduring rage toward parents, and difficulties with adult sexual functioning (143).

Long-term effects of child abuse and neglect may include juvenile and adult crime. A remarkable 40-year longitudinal study in eastern Massachusetts has followed the lives of **232** males raised in that area from the time the subjects were between 5 and 9 years old (410). The researchers gathered extensive information from the subjects' elementary school teachers and assessments made by social workers who visited the boys' homes twice a month for 5½ years. They subsequently gathered information for the study from court, mental hospital, and clinic records; death records; and a questionnaire mailed to the 98 percent of subjects who were successfully traced. The investigators found that one in five (20 percent) of the "abused and neglected" boys had been convicted of a serious juvenile crime. Among "rejected" children, the percentage of those who had been convicted of a serious juvenile crime was even higher (**29** percent). By comparison, relatively few (**7** percent) of the boys from "loving" families had been convicted of such a crime.

The association between maltreatment and adult crime was studied by Lewis and colleagues (379a). Almost one-half of the 97 neglected or abused children studied had become criminal, alcoholic, mentally ill, or died before reaching 53 years of age. There were no significant differences between those who were maltreated and those who were not in terms of occupational status, marital status, alcoholism, or use of physical punishment on their children.

In summary, the outlook for maltreated children is not good. While some children appear to be invulnerable, and on most measures there is a wide range of outcomes, research findings and clinical experience attest to significant physical, cognitive, and emotional harm. There is little comfort in observing that some studies found few differences in outcomes between maltreated children and children from violent and impoverished

neighborhoods (152) or from distressed families involved with child welfare agencies (762).

### **Financial Costs Attributable to Child Maltreatment**

Some, though by no means all, of the financial costs incurred nationally and attributable to child maltreatment in 1983 have been estimated by Daro (125). According to AAPC data, in 1983, an estimated 23,648 children in the United States experienced serious physical injury due to maltreatment, including brain damage, skull fractures, bone fractures, internal injuries, poisoning, and burns (23). Assuming that half of these children required hospitalization for 5.2 days (the mean length of stay for children with fractures), Daro calculated that inpatient medical costs for these children exceeded \$20 million. Rehabilitation and special education services in the year following the maltreatment, according to Dare, cost an estimated \$7 million (125).

Daro also calculated the short- and long-term costs of foster care associated with child maltreatment in 1983 (125), although her estimates of foster care costs are probably too high. Daro assumed that 75 percent of all confirmed maltreatment case reports to child protective services agencies in 1983 resulted in a child's spending at least some amount of time in foster care. This assumption yielded an estimate that there were **554,254** foster care placements in 1983, with an estimated first-year cost of \$1.9 billion and long-term costs of \$27 billion (125). According to AAPC data for 1984, only about 18 percent of newly opened child protective services cases were placed in foster care (**24**). If this AAPC estimate is accurate, then Dare's estimates of foster care costs are too high by a magnitude of four. Adjusting her cost estimates downward by a magnitude of four, however, still yields enormous costs for the foster care of children maltreated in 1983—first-year costs of \$475 million and long-term costs of \$6.77 billion.

Unmeasured long-run costs of child maltreatment are the cost of increased juvenile delinquency and adult crime that disproportionately occurs in victims of maltreatment. Estimates of these costs have not been attempted, but they are likely to be high.

## EFFECTIVENESS OF PREVENTIVE STRATEGIES AND PROGRAMS<sup>5</sup>

The previous section described the enormous human and financial costs associated with child maltreatment. The question is what can be done to prevent such maltreatment?

Strategies to prevent child maltreatment are generally of two types:

- c strategies intended to prevent reoccurrences of maltreatment in children who have already been abused or neglected, and
- strategies that seek to prevent initial instances of child maltreatment in high-risk families.

Traditional preventive efforts have generally sought to prevent reoccurrences of maltreatment, primarily through social case work. In all 50 States, child protective services agencies are required by law to respond to reports of alleged child maltreatment, and their mandate is to ensure the protection and adequate care of children. Typically, this task involves regular monitoring of family situations and efforts to enhance family functioning, such as supportive counseling and referrals to local resources. In instances of serious injury or risk to a child, child protective services agencies have the authority, after obtaining judicial consent, to remove children from their families and temporarily place them in substitute care.

The fact that reported child maltreatment rates in this country have been rising suggests that the traditional combination of social and legal services—at least in its present form—cannot cope with the magnitude of the problem. Social workers must deal with large caseloads and legal ambiguities, and the legal system must struggle with adapting rules developed to protect individual rights to family interfunctional problems. The remainder of this chapter, therefore, examines some innovative interventions that go beyond these traditional methods.

<sup>5</sup>The child maltreatment prevention programs described in this section are directed almost exclusively at parents or stepparents. Given the harmful effects of maltreatment on affected children, there is a clear need for treatment of maltreated children. Some evidence argues that an element common to all terms of child maltreatment is psychological maltreatment (258). The organization and effectiveness of children's mental health treatment services are discussed in a recent OTA background paper entitled *Children Mental Health Problems and Services* (bb31).

The previous discussion of the causes of child maltreatment suggests various strategies for intervention. Strategies to prevent maltreatment by changing factors for which research has demonstrated little or no causal impact on child maltreatment (e. g., parental mental illness) are not likely to be effective. Strategies to prevent child maltreatment by reducing poverty-related stress and violent responses to that stress are likely to be more effective. The stress associated with these conditions might be ameliorated by referring families to agencies that offer aid in obtaining such things as food stamps, Medicaid, and employment.

Given all the interest in preventing child maltreatment in this country, it is remarkable that relatively few child maltreatment prevention programs have been rigorously evaluated to ascertain their short- and long-term outcomes. Furthermore, in the assessments of prevention strategies that exist, the outcome measures (e. g., change in knowledge about child development, change in clinicians' estimates of propensity for maltreatment, or children's prediction of their responses to a hypothetical abusive incident) have generally been rather remote proxies for child maltreatment. Assessments of prevention programs in the area of sexual abuse have not examined outcomes in terms of actual behavior and the occurrence of subsequent sexual abuse. Another typical flaw in the evaluation of child maltreatment prevention programs is the absence of appropriately matched comparison groups. Many evaluations have no comparison group whatsoever.

A recent multiple-site evaluation of 19 demonstration projects funded by NCCAN that sought to intervene in problem families to prevent reoccurrences of child maltreatment is discussed below. Also discussed are evaluations of selected programs emphasizing the use of home health visitors in high-risk situations in order to prevent initial abuse and neglect.

### Effectiveness of 19 Federally Funded Clinical Demonstration Projects

Between 1979 and 1981, NCCAN sponsored a national evaluation by Berkeley Planning Asso-

ciates of 19 NCCAN-funded clinical demonstration projects (56). The 19 projects were intended to demonstrate the effects of specialized clinical treatments in five abuse and neglect subpopulations (sexual abuse, adolescent maltreatment, substance-abuse-related maltreatment, child neglect, and remedial services to maltreated children). It was hoped that by focusing on one aspect of the maltreatment problem, a project would be better able to tailor its service programs to a more narrow range of problems, thereby improving its success rates.

The client database for the evaluation of the 19 projects was drawn from the caseloads of the demonstration projects from October 1979 to October 1981. The sample consisted of 986 families, including 1,250 adults, 710 adolescents, and 975 children. Over 60 percent of the sample families were involved in more than one type of maltreatment.

Each family's clinical progress was assessed along three dimensions:

- the recurrence of maltreatment during treatment,
- clinician judgment about propensity for future maltreatment, and
- Clinician judgment of the client's overall progress.

Between 40 and 60 percent of infants, children, and adolescents were maltreated while their families were in treatment. Recurrence of all types of maltreatment during treatment occurred in 21 percent of families in treatment. By the time treatment was terminated, only 40 percent of the children and adolescents were residing in the same household and with the caretaker they had been with at the start of treatment. Recurrence of sexual abuse was least frequent, and recurrence of child neglect most frequent. Recurrence of maltreatment during treatment was not found to be associated with the receipt or nonreceipt of any particular service.

Adult clients of the demonstration projects showed substantial amelioration of various functioning problems during treatment (e.g., 57 percent improved in their knowledge of child development, 55 percent in understanding their child's needs, 49 percent decreased their excessive "need"

for their child to obey commands, and 47 percent had more self-esteem). Despite such progress, however, at the termination of treatment over 50 percent of adult clients were judged likely to maltreat their children in the future.

Annual costs were calculated for hypothetical service models to serve groups of 100 families. Total annual costs of programs for 100 families ranged from **\$516,000** to **\$1,600,000**. Individual psychotherapy, particularly for children and adolescents, was found to be an especially expensive intervention.

There are several critical flaws in this evaluation. First, and most important, the demonstration projects were not designed as controlled or even quasi-controlled experiments. There were no comparison groups, let alone a control group where clients are randomly assigned to programs. Second, the use of clinician judgment as an outcome measure is questionable. Clinicians working with families cannot be expected to make unbiased judgments of their clients' progress; a clinician's faith in his or her therapeutic ability, hopes for a client, and knowledge that one's work is being evaluated might be expected to influence a clinician's final assessment.

Although the evaluation's findings with respect to recurrence of maltreatment during treatment were not encouraging, the investigators argue that one-third of the recurrence cases were less serious than they were originally and that there might have been more maltreatment in the absence of the program. Without a comparison group in the evaluation, however, it is impossible to ascertain whether more maltreatment might have occurred in the absence of the program. Last, as the investigators themselves acknowledge, the lack of outcome data beyond the time of the clients' termination with the demonstration programs is a serious limitation. Continuation of the evaluation was proposed, but additional funding from NCCAN was not available.

### **Effectiveness of Five Home Health Visitor Programs**

Evaluations of five programs emphasizing the use of home health visitors to prevent child maltreatment in families at risk are discussed be-

low. All five programs provided a wide array of services, consistent with a view that no single causal factor can explain child maltreatment and hence that no specific single intervention is likely to be effective by itself. Most of the programs are intended to prevent initial instances of maltreatment, although one of them (Project 12-Ways) was aimed at preventing reoccurrences of maltreatment.

### **Intensive Pediatrician Contact and Home Visits to High-Risk Mothers**

One home health visitor project provided intensive pediatrician contact (office visits and telephone calls) and weekly home visits by public health nurses to a random sample of 50 high-risk mothers who had had their first or second child at Colorado General Hospital (225). The project also involved coordination of screening, medical followup, and home visits by lay health visitors.

For purposes of evaluating this project, Gray and colleagues randomly selected high-risk and low-risk comparison groups (225). The assessment of project outcomes, completed when a child was between the ages of 17 and 35 months, included measures of verified abuse and neglect reports to the central child abuse registry, hospitalization for serious injuries, number of accidents, foster care placements, and developmental tests.

The Gray, et al., study found that five children in the high-risk control group required hospitalization for serious injuries thought to be abuse-related, compared to no children in the high-risk homes visited and no children in the low-risk control group ( $p < 0.01$ ).

### **Hospital Support and Home Visits to Low-Income Mothers**

The effectiveness of early and extended contact between a mother and her newborn infant, combined with a program of home visits by paraprofessionals, has been evaluated by Siegel, et al. (586). The population that received the interventions was a group of low-income women who received care at a public prenatal clinic and who delivered at the community hospital in Greensboro, North Carolina. Altogether 321 low-income women (about three-fourths black and two-thirds

unmarried) were randomly assigned to varying combinations of hospital and home support interventions and to a nonintervention control group. The home intervention consisted of nine visits by paraprofessionals during the first 3 months of the infant's life; these visits were intended to promote the mother's involvement with her infant and to support the mother in coping with a range of situational stresses.

The outcome assessment was completed when the infant was 4 and 12 months of age. Outcome measures consisted of maternal attachment, immunizations, preventive care visits, emergency room visits, hospitalizations, and reports of child abuse and neglect obtained from the county unit for protective services and the State central registry. With one exception, neither rooming-in nor home visits had a statistically significant effect on any of the outcome measures. An exception was a small amount of variance in maternal attachment that appeared to be linked to rooming-in.

### **Home-Based Services and Support Groups for Families at Risk**

The effectiveness of a program developed by the Family Support Center in Yeadon, Pennsylvania, for families considered to be at risk for maltreating their preschool age children has been evaluated by Armstrong (33,34).

A multidisciplinary staff and volunteers offered three services to parents and children in the Family Support Center program:

- home-based services (weekly visits for the first 3 months and less frequent visits for up to 10 months),
- family school support groups, and
- neighborhood support groups.

Also offered was a wide array of counseling, educational, health-related, and social activities.

To enter the Family Support Center program, self-referred families and families referred by local agencies and medical sources were screened by a high-risk stress index. Armstrong's program evaluation was based on 46 families and their 74 children referred from the following sources:

- self-referrals (10 families),
- child protective agencies (10 families),



- hospitals (9 families),
- preschool programs (7 families),
- mental health agencies (4 families),
- community nursing agencies (3 families), and
- recommendations of other families who had participated in the program (3 families).

Armstrong's evaluation of the Family Support Center used three outcome measures: 1) a high-risk stress index that counted the number of stresses incurred by each family, 2) parent-child observations done in the home, and 3) a children's developmental index. Pretest and posttest measures on these three measures were obtained, but there was no control or comparison group. Armstrong did, however, compare the percentage of children in the study who had a formal report of child abuse and neglect filed on their behalf with the child protective service agency during treatment with the percentage of children from a similar high-risk population reported in another study. Armstrong's evaluation of the Family Support Center indicated that family stresses were significantly reduced, parent-child interactions and child care conditions improved, developmental delays were reduced, and significantly fewer children were maltreated during the study period.

### Home Visits and Other Services for High-Risk Pregnant Women and Mothers

Olds and colleagues examined the effectiveness of a family support program during pregnancy and the first 2 years after birth (471) for women who were having their first baby and were also under 19 years of age, single, or of low socioeconomic status. In a randomized clinical trial, four treatment groups were provided with different combinations of the following services:

- home visits by nurses during the mother's pregnancy,
- free transportation of mothers and children to prenatal and well-child visits,
- sensory and developmental screening of the children, and
- home visits by nurses during the child's first 2 years of life.

The nurse-visited and comparison group women were equivalent in all standard socio-demographic characteristics, and the researchers

controlled for the few differences in psychological and social support variables in their analyses.

The nurse home visitor had three major activities. One was to educate parents about fetal and infant development and to clarify the parents' plans for completing their education, finding jobs, and bearing additional children. The second activity was to involve family members and friends in child care and support of the mother. The third activity was to link family members with other health and human services. All of these activities were aimed at a number of factors believed to be potential contributors to child maltreatment, including parental knowledge of child development, unemployment/poverty, and social isolation.

Olds found that in the mothers at highest risk—poor, unmarried teenaged mothers—19 percent of the comparison group maltreated their children, compared to 4 percent of the mothers who were visited by nurses for the extended period. (Maltreatment was measured by verified cases of abuse or neglect reported to the New York State Department of Social Services, ) Furthermore, among this same high-risk group, the mothers who were nurse-visited reported that their babies cried less frequently than those in the comparison group; there was less conflict and scolding; they punished their infants less when assessed at 10 and 22 months of age; they had fewer emergency room visits, and their babies had higher developmental quotients at 12 and 24 months. These findings constitute a clear pattern of improvements made by the highest risk group of poor, unmarried, teen mothers,

### Project 12-Ways Services to Families Referred From Child Protective Services

Lutzker and Rice evaluated the effectiveness of a project that attempted to reduce *reoccurrences* of child maltreatment in families by providing a variety of in-home services—e.g., training in stress reduction, home safety and parenting skills; job placement; alcoholism referral; and couples counseling.

The population studied consisted of families referred from the child protective services agency for the State of Illinois. The study compared 50 families served by Project 12-Ways and 47 com-

parison protective services families for incidents of abuse and neglect during and after treatment.

Lutzker and Rice found that Project 12-Ways families had fewer children abused and neglected during and after treatment than did comparison protective services families (10 v. 22 percent). Project 12-Ways families also had fewer children abused or neglected two or more times and fewer total abuse and neglect incidents (5 v. 15 percent).

Although the sample sizes were small, the differences between the experimental and comparison groups in this study were statistically significant. Unfortunately, however, the selection of families into Project 12-Ways was not random and no demographic data were reported by the investigators. Consequently, it is impossible to know whether the observed effects were real or were merely the result of systematic differences between the experimental and comparison groups.

### Conclusions About the Effectiveness of Home Health Visitor Programs

Four of the five evaluations of home health visitor programs described above indicate that home health interventions are quite effective in reducing actual child maltreatment, as well as in influencing other outcome measures of interest (33,34, 225,391,471 ).<sup>6</sup>

The fifth study, which had a randomized design, found that intensive postpartum contact and home visits by paraprofessionals had almost no significant effects (586). Several factors other than the potential effectiveness of home health visits might account for the outcome of this study by Siegel, et al. First, a 3-month program of nine home visits may not provide sufficient contact to establish effective rapport (470).<sup>7</sup>Second, among

<sup>6</sup>Although the Gray, et al., study of pediatric care and home visits (225) did not show a statistically significant effect of home visits on child maltreatment reports to a central registry, home visits had a statistically significant effect on *abuse-related* hospitalization; moreover, for the non-home-visited-high-risk group, there was evidence of underreporting of abuse incidents to the central registry.

<sup>7</sup>The Gray, et al., study (225) indicated weekly visits by public health nurses for a period of at least 17 months. The Armstrong study (33,34) indicated weekly visits for the first 3 months and less often for the next 7 months. The Lutzker, et al., study (390) indicated home visits for about 1 year, although no information was provided about the frequency of visits. The Olds, et al., study (471) indicated nine visits during pregnancy, weekly visits for 6 weeks following delivery, and less frequently thereafter for a period up to 2 years following delivery.

the five programs evaluated, the North Carolina program evaluated by Siegel, et al., was the only one with home visits conducted by paraprofessionals. It may be that paraprofessionals are less able to obtain the respect of families and less able to communicate effectively with physicians than professionals (470). Third, the Siegel, et al., study did not analyze the potential effects of home visits on any high-risk subgroup within the low-income study population (e. g., among families referred to child protective services). Fourth, in the two other studies where the racial composition of the study population was indicated, the study population was mostly or exclusively white; in contrast, the study population in the Siegel, et al., study was three-quarters black. Finally, given the relative rarity of child maltreatment, even in high-risk groups, it is extraordinary that significant differences were found in any of the studies with so few subjects.

It is difficult to know which program elements or combination of elements are the most important in producing the positive results. Three of the four home visitor programs that appear to have reduced child maltreatment also offered additional services such as intensive pediatrician contact. With the exception of the report by Olds, et al., on the family support program in New York (471), none of the study reports offered much detail on the content of home visitor services. All that can be said is that the common denominator is the provision of in-home services to a population at high-risk for child maltreatment.

It is difficult to know if the results of these pilot home visitor programs run by dedicated, enthusiastic, and skilled people could be replicated in other settings where the intervention may be carried out by less skilled and enthusiastic people (245). Nevertheless, the home health visitor program model appears to have a number of practical advantages that enhance its effectiveness, including:

- reaching parents who lack self-confidence and trust in formal service providers,
- obtaining a more accurate and direct assessment of the home environment,
- linking parents with other health and human services, and

•serving “as a visible and regular reminder to parents that excessive punishment and ne-

glect of children in our society are not condoned” (470).

## FEDERAL AND STATE FUNDING FOR THE PREVENTION OF CHILD MALTREATMENT

Between 1981 and 1985, the resources available for the prevention and treatment of child abuse and neglect did not keep pace with the rapid increases in the reported number of maltreated children (657). For the 31 States able to provide complete information, total resources to serve abused and neglected children increased, in real terms, by less than 2 percent between 1981 and 1985 (657). In 29 of 31 States reporting such information for 1981-85, reports of child maltreatment rose faster than available Federal, State, and local resources (657).

Four Federal programs give funding to States for the prevention and treatment of child abuse and neglect: Title XX, Title IV-B, and Title IV-E of the Social Security Act, and the Child Abuse Prevention and Treatment Act (Public Law 93-247 ).<sup>1</sup>

The largest source of Federal funds, and in some States the largest single source of funds, for child protection services is the Title XX (Social Services) block grant. Title XX provides funds to States for a wide variety of social services, including home-based services for elderly people, transportation for handicapped people, and child protection services for abused and neglected children. From fiscal year 1981 to 1986, Federal appropriations for Title XX declined—from \$2.9 billion in 1981 to \$2.6 billion in 1986. No breakdown on the percentage of Title XX expenditures that were used to benefit children—let alone to treat or prevent child abuse and neglect—is available. The U.S. Department of Health and Human Services has estimated, however, that about one-third (31 percent) of Title XX expenditures in 1980 were for services provided to children and youth.

Title IV-B of the Social Security Act provides matching Federal grants to States for the provision of child welfare services to children and families, irrespective of income. In comparison to Title XX, this program is very small. In fiscal year 1981, appropriations for Title IV-B were only \$141 million; in fiscal year 1985, the appropriations were increased to \$200 million.

Title IV-E of the Social Security Act provides matching funds to States for maintenance of children in foster care who are eligible for AFDC. Title IV-E is an entitlement program for eligible children, and the amount each State receives is based on the number of children the State places in foster care, which includes abused and neglected children. Title IV-E funds increased from \$349 million in fiscal year 1981 to \$485 million in fiscal year 1985.

The Child Abuse Prevention and Treatment Act is the only Federal program designed solely to prevent, identify, and treat child abuse and neglect. Under this act, Federal funds are provided to the National Center on Child Abuse and Neglect (NCCAN) to award as State and discretionary grants for projects related to child abuse and neglect. As shown in table 8-3, overall funding for NCCAN State and discretionary grants increased from \$23.0 million in fiscal year 1981 to \$24.7 million in fiscal year 1986, with significant funding reductions in the intervening years.

NCCAN grants to eligible States and territories may be used for any child abuse and neglect-related activities, provided the States meet specified requirements that include mandatory reporting of child abuse and neglect by professionals, immunity from prosecution for those who report, and prompt investigation of all reports. State grants rarely go into direct services; they are usually used as seed money for innovative programs.

<sup>1</sup>Information and data on sources of funding in this section are derived from *Abused Children in America: Victims of Official Neglect*, a 1987 report by the House Select Committee on Children, Youth, and Families (657).

**Table 8-3.—National Center for Child Abuse and Neglect (NCCAN) Funding for State and Discretionary Grants, Fiscal Years 1981-86 (millions of dollars)**

	FY 1981	FY 1982	FY 1983	FY 1984	FY 1985	FY 1986
State grants . . . . .	\$ 7.0	\$6.7	\$6.7	\$6.7	\$12.0	\$11.4
Discretionary grants . . . . .	16.0	9.5	9.5	9.5	14.0	13.3
Total . . . . .	\$23.0	\$ 16.2	\$16.2	\$ 16.2	\$26.0	\$24.7

SOURCE U S Congress, House Select Committee on Children, Youth, and Families, *Abused Children in America Victims of Official Neglect* (Washington, DC: U S Government Printing Office, March 1987)

NCCAN discretionary grants are awarded to public agencies, private nonprofit organizations, and universities for projects that relate to the prevention, identification, and treatment of child abuse and neglect. Discretionary grants are awarded for research, demonstration, and improvement of existing service programs.

There have been a number of criticisms of NCCAN's discretionary grants program. In 1980, the General Accounting Office (GAO) found that "due to a largely unsuccessful evaluation program, the Center has been unable to determine which programs work best" (367,651). At hearings conducted by the House Committee on Government operations, March 12, 1987, the lack of evaluations of child abuse and a propensity of NCCAN to ignore the recommendations of its peer review panel in making grant awards were raised in critique of the Center (655).

In fiscal year 1986, the vast majority (about 80 percent) of NCCAN discretionary grant expenditures were for demonstration projects, followed by research (about 15 percent) and training and technical assistance (about 5 percent) (678). Although NCCAN grants for research (e.g., research on how to improve the accuracy and credibility of children's testimony in sexual abuse cases) may yield valuable information, demonstration proj-

ects are the only potential source of evaluations of program effectiveness. Discerning the design of the projects from the discretionary grant abstracts is difficult, but only 2 of 87 demonstration projects active in 1986 appear to have a carefully designed program evaluation. In addition, there appear to be no longitudinal studies among those funded. Although evaluation studies are inherently difficult, the current pattern of funding is not likely to remedy the problems identified in the GAO's 1980 report (651).

The Federal Government is not the only source of funds in the area of child maltreatment. Many State and local governments provide resources for the prevention and treatment of child abuse and neglect, and in some States, State and county funds are the largest source of funding. Funds are provided from State general funds, children's trust funds, and other State and local programs. Between fiscal years 1981 and 1985, 15 of the 31 States supplying complete funding information reported a net decrease (in constant 1982 dollars) in State and local funds directed at child abuse and neglect; the remaining 16 States reported a net increase (657). State and local funds for all 31 States showed a total net gain of \$169.2 million, with most of the increase in one State alone, California.

## CONCLUSIONS

Child maltreatment is a serious problem, affecting the lives of many children and families. Knowledge about child maltreatment is growing steadily. Evaluation research and cost-effectiveness analyses of maltreatment prevention programs do offer some useful insights; however, adequate information about which preventive ap-

proaches work, for whom, and under what circumstances still does not exist. Rigorous scientific assessment in the field *is* clearly needed.

Leventhal (375), Finkelhor and Araji (172), and Gray and DiLeonardi (223) have offered useful guidance for research in child maltreatment. Two

key methodological requirements for evaluation studies are the clear definition of outcome measures and the use of appropriate comparison groups. However, there are inherent difficulties in conducting research on child maltreatment. In high-risk situations, the random assignment of children considered to be in need of services to treatment or comparison groups would not always be ethical. One alternative is to compare different programs or to study children waiting for placement in a treatment program as a comparison group. These so-called “natural experiments” have not been sufficiently utilized in this area of research.

Another problem for researchers is measuring the key outcome—i.e., the occurrence of child maltreatment. Child maltreatment reports are often confidential, and direct observation of maltreatment is virtually impossible. In some areas, child protection agencies have cooperated with researchers, or have hired their own research staff, while protecting the confidentiality and rights of clients. Measures of actual child maltreatment are the bottom line, and “it will not suffice to substitute measures of attitude alone” (194) or behavior apart from maltreatment.

In order to obtain adequate measures of actual abuse, it is particularly important to develop a better child abuse reporting system. The reporting system should be able to provide measures that permit distinctions between incidence and severity. Child homicide cases in particular need to be closely monitored. A study of two information sources, the Federal Bureau of Investigation’s Uniform Crime Reports and National Center for Health Statistics data, indicates that each source underrecords child homicide by at least 20 percent (217,300,302).

Very little longitudinal followup assessment has been done, largely because of budget constraints. Long-term outcomes are of critical interest, and research in this area is imperative.

The evaluations of child maltreatment prevention programs summarized in this chapter suggest that the home health visitor model, using a nurse, social worker, or counselor to support high-risk families, is probably effective. Furthermore, the home health visitor model seems to offer a number of practical advantages that enhance its effectiveness (e.g., reaching parents who avoid or are mistrustful of formal service providers). The model also builds on a public health activity that has an institutional base in home-health agencies and public health departments. Whether maltreatment prevention programs with these characteristics can result in net savings in total health care costs is a question that needs further research.

Of course, there maybe other kinds of preventive interventions that hold promise and have not been adequately tested. If poverty- and unemployment-related stresses are important causes of child maltreatment, as has been suggested, then interventions focusing on reduction or management of these stresses may be effective. Some observers have suggested, for example, that intervention programs should provide concrete assistance to families in resolving problems having to do with inadequate income, poor housing, lack of medical care, and lack of formal and informal social supports (124). Unfortunately, careful evaluations of such interventions are lacking.

---

<sup>g</sup>There is evidence that visiting nurses can also be effective in improving birthweight and length of gestation (469), and lowering infant mortality, particularly, mortality due to sudden infant death syndrome (94).

# Appendixes

# Method of the Study

---

This assessment was requested by the House Energy and Commerce Committee and its Health Subcommittee and the Senate Committee on Labor and Human Resources. The committees asked OTA to examine the status of children's health; problems in children's access to effective health services; and the effectiveness and costs of selected technologies, particularly preventive strategies for improving the health of children. In addition, the Senate Finance Committee asked for an assessment of a new technology for prenatal care: tocodynamometry. The assessment began on October 1, 1985.

One of the first tasks in planning an OTA assessment is to choose an advisory panel of experts in various fields. The advisory panel for an OTA assessment suggests source materials, subject areas, and perspectives for staff consideration; assists in interpreting information and points of view assembled by OTA staff; and suggests possible findings and conclusions based on the study. Panel members review staff and contract materials for accuracy and representativeness, discuss policy options of the study, and present arguments for and against the options and conclusions. The final report, however, is the responsibility of the OTA staff.

The advisory panel for this assessment of technologies related to child health consisted of 18 members with expertise in health policy, health economics, clinical medicine, law and medical ethics, as well as experience in State and Federal Government and academia. The advisory panel was chaired by Harvey Fineberg, Dean of the Harvard School of Public Health.

The first panel meeting was held on February 11, 1986. OTA staff for the project presented topics for the panel's discussion of the overall plan for the assessment. Major chapter topics selected for study were the

problem of infant mortality, family planning, prenatal care, neonatal intensive care, newborn screening, well-child care, prevention of accidental injuries, and prevention of child maltreatment.

Contracts were let for background papers and acquisition of data on a variety of issues for staff use in preparing the assessment. These contracts are listed at the end of this appendix. Background papers with an asterisk (\*) are or will soon be available from the National Technical Information Service (NTIS).

OTA prepared two documents in addition to the main report for this project. They include a technical memorandum, *Technology-Dependent Children: Hospital v. Home Care*, and a case study, *Neonatal Intensive Care for Low Birthweight Infants: Costs and Effectiveness*. They are available from the U.S. Government Printing Office.

The second meeting with the advisory panel was held on August 5, 1986. OTA staff presented outlines of each chapter for the panel's discussion. In addition, some preliminary data were presented for discussion. Suggestions for improvement were provided by the panel members.

At the last panel meeting, on February 24, 1987, OTA staff had prepared a draft of the final report. The panel was mailed a copy prior to the meeting. Comments were provided by the panel and discussed at the meeting. It was agreed that OTA staff would revise the draft and send it out for a broader review.

After revising the main report, OTA staff mailed the second draft to more than 125 reviewers. These reviewers represented a broad range of experts in a diversity of settings. Appropriate revisions based on comments received were made by OTA staff, and the report was submitted to the Technology Assessment Board on July 27, 1987.

<b>Contractor</b>	<b>Subject</b>
<b>Martha Burt</b> The Urban Institute Washington, DC	Pregnancy Prevention Strategies for Improving Child Health
Howard Dubowitz University of Maryland Medical School Baltimore, MD	Child Maltreatment in the United States: Etiology, Impact, and Prevention*
Isaac Eberstein and Robert Weller Center for the Study of Population Florida State University Gainesville, FL	Data Analysis of 1980 National Natality Survey on the Adequacy of Prenatal Care and Pregnancy Outcome
Warren Greenberg Department of Health Services Administration The George Washington University Washington, DC	The Impact of Product Liability Laws on the Costs of Injury Prevention Devices and Products
Charles Homer Massachusetts General Hospital Boston, MA	Evaluation of the Effectiveness of Well-Child Care Services for Children*
Information Service Center, Inc. Baltimore, MD	Maryland Hospital Use and Cost Data
Michael Kenney Pinole, CA	Task I—Assessment of CDC's Quality Assurance and Proficiency Testing in Newborn Screening Task II—Description and Comparison of Four Neonatal Screening Programs in the United States
Lorraine Klerman and Helen Burst Yale University New Haven, CT	Summary of Recommendations on and Evidence of the Effectiveness of Recommended Prenatal Care Components*
Peter McMenamin Washington, DC	Medicaid Participation by Pediatricians and Obstetricians*
Bonnie Preston Takoma Park, MD	Description of the Early and Periodic Screening, Diagnosis, and Treatment Program: History, Evaluation, and Issues*
Leon Robertson Nanlee Research Branford, CT	Costs and Effectiveness of Strategies To Prevent Unintentional Childhood Injuries*
T. Paul Schultz Economic Growth Center Yale University New Haven, CT	Data Analysis of the 1980 National Natality Survey: Prenatal Care for Low Income Women
Katherine Swartz The Urban Institute Washington, DC	Task I—Data Analysis of the Current Population Survey and Children's Health Insurance Coverage Task II—A Note on the Strengths and Weaknesses of Using the CPS To Estimate Children's Health Insurance Coverage*

\*Available from the National Technical Information Service, Springfield, VA



# Acknowledgments

---

The development of this report has benefited from the advice and review of a number of people in addition to the Advisory Panel. OTA staff would like to express its appreciation of the following people for their valuable guidance.

Kathryn Allen  
U.S. General Accounting Office  
Washington, DC

Merelina Amoni  
National Highway Traffic Safety Administration  
Washington, DC

Susan Baker  
Johns Hopkins School of Public Health  
Baltimore, MD

Wendy Baldwin  
National Institute of Child Health and  
Human Development  
National Institutes of Health  
Bethesda, MD

Howard Barden  
Lunar Corp.  
Madison, WI

Steven Barid  
Centers for Disease Control  
Atlanta, GA

Heinz Berendes  
National Institute of Child Health and  
Human Development  
Bethesda, MD

James Bowman  
University of Chicago  
Chicago, IL

Claire Brindis  
Institute for Health Policy Studies  
University of California at San Francisco  
San Francisco, CA

Sarah Brown  
Institute of Medicine  
Washington, DC

James Buehler  
Centers for Disease Control  
Atlanta, GA

Neil Buist  
Oregon Health Sciences University  
Portland, OR

Alex Calcagno  
American Academy of Pediatrics  
Washington, DC

Steven Caritis  
Magee-Women's Hospital  
Pittsburgh, PA

Patricia Castiglia  
State University of New York at Buffalo  
Buffalo, NY

Anne Cohn  
National Committee for the Prevention of  
Child Abuse  
Chicago, IL

Robert Creasy  
University of Texas Medical School  
Houston, TX

George Cunningham  
California Department of Health Services  
Berkeley, CA

Deborah Daro  
National Committee for the Prevention of  
Child Abuse  
Chicago, IL

Richard David  
Tokos Medical Corp.  
Santa Ana, CA

Jessica Davis  
North Shore University Hospital  
Cornell University  
Manhasset, NY

John Driscoll  
Columbia-Presbyterian Medical Center  
New York, NY

Patrick Dwyer  
Pittsburgh Plate Glass Biomedical  
Pleasantville, NY

Donald Eddins  
Centers for Disease Control  
Atlanta, GA

Patrick Ferreira  
University of Alberta Hospitals  
Edmonton, Alberta, Canada

Les Fisher  
New York Public Health Department  
New York, NY

Gretchen Fleming  
American Academy of Pediatrics  
Elk Grove Village, IL

Samuel Flint  
American Academy of Pediatrics  
Elk Grove Village, IL

Jacqueline Forrest  
Alan Guttmacher Institute  
New York, NY

Irene Forsman  
Health Resources and Services Administration  
Rockville, MD

Eva Friedman  
Children's Hospital of Los Angeles  
Los Angeles, CA

Sarah Friedman  
National Institutes of Health  
Bethesda, MD

Susan Gallagher  
Harvard School of Public Health  
Boston, MA

James Garbarino  
Erikson Institute for Advanced Study in  
Child Development  
Chicago, IL

Richard Genes  
University of Rhode Island  
Kingston, RI

Michael Glass  
Washington State Public Health Laboratory  
Seattle, WA

Sheila Gordon  
Laboratories Administration  
Maryland State Department of Health and Hygiene  
Baltimore, MD

Jeanne Griffith  
Congressional Research Service  
Washington, DC

Robert Guthrie  
State University of New York at Buffalo  
Buffalo, NY

Bernard Guyer  
Massachusetts Department of Public Health  
Boston, MA

Jack Hadley  
Washington, DC

Neal Halfon  
University of California, Berkeley  
Berkeley, CA

David Hall  
St. George's Hospital Medical School  
London, England

Keith Hammond  
University of Colorado  
School of Medicine  
Denver, CO

James Hanson  
University of Iowa Hospitals and Clinics  
Iowa City, IA

James Harisiades  
American Academy of Pediatrics  
Elk Grove Village, IL

Robert Hartford  
National Center for Health Statistics  
Hyattsville, MD

David Hassemer  
University of Wisconsin Center for Health Sciences  
Madison, WI

John Hauth  
University of Alabama  
Birmingham, AL

David Heppel  
Health Resources and Services Administration  
Rockville, MD

Lindsay Hofman  
State Laboratory of Public Health  
Raleigh, NC

Philip Home  
Centers for Disease Control  
Atlanta, GA

Vince Hutchins  
Health Resources and Services Administration  
Rockville, MD

L. Stanley James  
Columbia-Presbyterian Medical Center  
New York, NY

Ted Joyce  
National Bureau of Economic Research  
New York, NY

Harold Kaminetzky  
American College of Gynecology  
Washington, DC

Michael Katz  
University of California, San Francisco  
San Francisco, CA

Asta Kenney  
Alan Guttmacher Institute  
Washington, DC

Raymond Kessel  
University of Wisconsin  
Madison, WI

Samuel Kessel  
Health Resources and Services Administration  
Rockville, MD

James King  
Mater Mothers' Hospital  
Brisbane, Australia

Michael Klass  
ICF, Inc.  
Washington, DC

Joel Kleinman  
National Center for Health Statistics  
Hyattsville, MD

Sydney Kling  
Illinois Department of Public Health  
Springfield, IL

Richard Koch  
Children's Hospital of Los Angeles  
Los Angeles, CA

Carol Korenbrot  
Institute for Health Policy Studies  
University of California at San Francisco  
San Francisco, CA

Mary Grace Kovar  
National Center for Health Statistics  
Hyattsville, MD

Charles Lakin  
University of Minnesota  
Minneapolis, MN

Robert Lawrence  
Cambridge Hospital  
Cambridge, MA

Robert Leibenluft  
Hogan & Hartson  
Washington, DC

Athole Lennie  
California Department of Health Services  
Sacramento, CA

Claire Leonard  
University of Utah School of Medicine  
Salt Lake City, UT

Aidan Macfarlane  
The Radcliffe Infirmary  
Oxford, England

Denise Main  
Mt. Zion Hospital  
San Francisco, CA

Edward McCabe  
Institute for Molecular Genetics  
Houston, TX

Marie C. McCormick  
Children's Hospital of Philadelphia  
Philadelphia, PA

Art McDonald  
Consumer Product Safety Commission  
Washington, DC

Peggy McManus  
McManus Health Policy, Inc.  
Washington, DC

F. John Meaney  
Indiana State Board of Health  
Indianapolis, IN

Janet Mitchell  
Center for Health Economics Research  
Needham, MA

John Morrison  
University of Mississippi Medical Center  
Jackson, MS

William Mosher  
National Center for Health Statistics  
Hyattsville, MD

Edwin Naylor  
Western Pennsylvania Hospital  
Pittsburgh, PA

Paul Newacheck  
University of California, San Francisco  
San Francisco, CA

Elena Nightingale  
Carnegie Corporation of New York  
Washington, DC

David Olds  
University of Rochester Medical Center  
Rochester, NY

Elsie Pamuk  
National Center for Health Statistics  
Hyattsville, MD

Nigel Paneth  
Columbia University  
New York, NY

Susan Panny  
Maryland Department of Health  
Baltimore, MD

Mary Peoples-Sheps  
University of North Carolina  
Chapel Hill, NC

Ciaran Pibbs  
University of California, San Francisco  
San Francisco, CA

Paul Placek  
National Center for Health Statistics  
Hyattsville, MD

Kate Praeger  
National Center for Health Statistics  
Hyattsville, MD

Linda Saltzman  
Centers for Disease Control  
Atlanta, GA

Peter Scheidt  
National Institutes of Health  
Bethesda, MD

Art Schletty  
Centers for Disease Control  
Atlanta, GA

Shirley Shelton  
American College of Obstetricians and  
Gynecologists  
Washington, DC

George Silver  
Yale University  
New Haven, CT

William Slazyk  
Centers for Disease Control  
Atlanta, GA

Roberta Spiro  
State of Washington Department of Social and  
Health Services  
Seattle, WA

Michael Sullivan  
University of Iowa Hospitals and Clinics  
Iowa City, IA

Brad Therrell  
Texas State Department of Health  
Austin, TX

Owen Thornberry  
National Center for Health Statistics  
Hyattsville, MD

Horace Thuline  
Genetic Services Division  
State of Washington Department of Social and  
Health Services  
Seattle, WA

Stephanie Ventura  
National Center for Health Statistics  
Hyattsville, MD

Ronald Wilson  
National Center for Health Statistics  
Hyattsville, MD

Barry Wolf  
Medical College of Virginia  
Richmond, VA

Sumner Yaffe  
National Institutes of Health  
Bethesda, MD

Laurie Zabin  
Johns Hopkins University School of Medicine  
Baltimore, MD

# U.S. Infant, Neonatal, and Postneonatal Mortality Rates

**Table C-1.—U.S. Infant Mortality Rate and Annual Percentage Change by Race, 1968-85**

Year	Infant mortality rate <sup>a</sup>					
	All races		Whites		Blacks	
	Rate	Percent change <sup>b</sup>	Rate	Percent change <sup>b</sup>	Rate	Percent change <sup>b</sup>
1968	21.8	—	19.2	—	36.2	—
1969	20.9	-4.3	18.4	-4.1	34.8	-3.9
1970	20.0	-4.0	17.8	-3.6	32.6	-6.1
1971	19.1	-4.5	17.1	-3.8	30.3	-7.1
1972	18.5	-3.4	16.4	-4.1	29.6	-2.3
1973	17.7	-4.1	15.8	-3.6	28.1	-5.1
1974	16.7	-5.7	14.8	-6.1	26.8	-4.7
1975	16.1	-3.8	14.2	-4.5	26.2	-2.1
1976	15.2	-5.2	13.3	-6.1	25.5	-2.5
1977	14.1	-7.3	12.3	-7.3	23.6	-7.5
1978	13.8	-2.4	12.0	-2.6	23.1	-2.2
1979	13.1	-5.3	11.4	-4.9	21.8	-5.8
1980	12.6	-3.6	11.0	-3.7	21.4	-1.9
1981	11.9	-5.4	10.5	-4.7	20.0	-6.4
1982	11.5	-3.5	10.1	-3.8	19.6	-1.8
1983	11.2	-3.1	9.7	-3.3	19.2	-2.3
1984	10.8	-3.4	9.4	-3.1	18.4	-4.3
1985	10.6	-1.3	9.3	-1.4	18.2	-0.9

<sup>a</sup>The infant mortality rate is defined as the number of infants who die in the first year of life per 1,000 live births.

<sup>b</sup>Percentage change computed on infant mortality rates per 100,000 live births.

SOURCE US Department of Health and Human Services, Public Health Service, National Center for Health Statistics, unpublished data from US vital statistics, Hyattsville MD, 1986.

**Table C-2.—U.S. Neonatal Mortality Rate and Annual Percentage Change by Race, 1968-85**

Year	Neonatal mortality rate <sup>a</sup>					
	All races		Whites		Blacks	
	Rate	Percent change <sup>b</sup>	Rate	Percent change <sup>b</sup>	Rate	Percent change <sup>b</sup>
1968	16.1	—	14.7	—	24.3	—
1969	15.6	-3.4	14.2	-3.8	23.9	-1.4
1970	15.1	-3.2	13.8	-2.8	22.8	-4.9
1971	14.2	-5.9	13.0	-5.4	21.0	-7.9
1972	13.6	-4.0	12.4	-5.0	20.7	-1.4
1973	13.0	-4.9	11.8	-4.3	19.3	-6.6
1974	12.3	-5.4	11.1	-5.9	18.7	-3.3
1975	11.6	-5.5	10.4	-6.9	18.3	-1.9
1976	10.9	-5.7	9.7	-6.9	17.9	-2.2
1977	9.9	-9.5	8.7	-9.4	16.1	-10.3
1978	9.5	-4.0	8.4	-4.1	15.5	-3.8
1979	8.9	-6.5	7.9	-6.0	14.3	-7.5
1980	8.5	-4.4	7.5	-5.1	14.1	-1.6
1981	8.0	-5.3	7.1	-5.4	13.4	-4.6
1982	7.7	-4.1	6.8	-4.2	13.1	-2.8
1983	7.3	-5.3	6.4	-5.6	12.4	-5.0
1984	7.0	-3.9	6.2	-3.6	11.8	-4.9
1985	7.0	-0.6	6.1	-1.3	12.1	+2.1

<sup>a</sup>The neonatal mortality rate is defined as the number of infants who die in the first 28 days of life per 1,000 live births.

<sup>b</sup>Percentage change computed on neonatal mortality rates per 100,000 live births.

SOURCE US Department of Health and Human Services Public Health Service, National Center for Health Statistics unpublished data from US vital statistics, Hyattsville MD, 1986.

**Table C-3.—U.S. Postneonatal Mortality Rate and Annual Percentage Change by Race, 1968-85**

Year	Postneonatal mortality rate <sup>a</sup>					
	All races		Whites		Blacks	
	Rate	Percent change <sup>b</sup>	Rate	Percent change <sup>b</sup>	Rate	Percent change <sup>b</sup>
1968	5.7	—	4.5	—	11.9	—
1969	5.3	-6.8	4.2	-5.0	10.8	-9.1
1970	4.9	-6.6	4.0	-6.1	9.9	-8.8
1971	4.9	0.2	4.0	+1.6	9.4	-5.4
1972	4.8	-1.7	4.0	-1.2	8.9	-4.3
1973	4.8	1.6	3.9	-1.6	8.8	-1.6
1974	4.4	-6.6	3.7	-5.7	8.1	-8.0
1975	4.5	+1.0	3.8	+2.4	7.9	-2.6
1976	4.3	-3.8	3.6	-4.0	7.6	-3.3
1977	4.2	-1.7	3.6	-1.6	7.6	-0.9
1978	4.3	+1.3	3.6	+1.1	7.6	+1.1
1979	4.2	-2.2	3.5	-2.5	7.5	-2.2
1980	4.1	-1.8	3.5	-0.6	7.3	-2.4
1981	3.9	-5.3	3.4	-3.4	6.6	-10.0
1982	3.8	-2.2	3.3	-3.0	6.6	+0.2
1983	3.9	+1.5	3.3	+1.3	6.8	+2.9
1984	3.8	-2.4	3.3	-2.2	6.5	-3.3
1985	3.7	-2.7	3.2	-1.4	6.1	-6.4

<sup>a</sup>The postneonatal mortality rate is defined as the number of infants between 28 days old and 1 Year old who die Per 1,000 live births  
<sup>b</sup>Percentage change computed on postneonatal mortality rates per 100,000 live births. For any given Year when the rate computed Per 1,000 live births appears not to change, there can be a small percent change from unrounded rates computed per 100,000 live births

SOURCE U S Department of Health and Human Services, Public Health Service, National Center for Health Statistics, unpublished data from U S vital statistics, Hyattsville, MD, 1986

**Table C-4.— U.S. Infant, Neonatal, and Postneonatal Mortality Rates and Relative Risk by Birthweight, 1980 Birth Cohort (Singletons)**

	Mortality rate and relative risk <sup>a</sup> by birthweight			
	< 1500g	< 2500g	≥ 2500g	
<b>Infant mortality:</b>				
All races	469.4 (93.9)	105.7 (21.1)	5.0	
Whites	475.3 (108.0)	103.9 (23.6)	4.4	
Blacks	443.2 (61.6)	106.3 (14.8)	7.2	
<b>Neonatal mortality:</b>				
All races	431.2 (205.3)	89.4 (42.6)	2.1	
Whites	441.9 (221.0)	89.5 (44.8)	2.0	
Blacks	398.9 (147.7)	87.0 (32.2)	2.7	
<b>Postneonatal mortality<sup>b</sup>:</b>				
All races	67.0 (23.1)	17.9 (6.2)	2.9	
Whites	59.9 (24.0)	15.8 (6.3)	2.5	
Blacks	73.6 (16.4)	21.2 (4.7)	4.5	

<sup>a</sup>The numbers in parentheses denote relative risk. Relative risk is defined as the mortality rate of infants in a specified low birthweight category divided by the mortality rate of infants born at normal birthweight (i.e., ≥ 2500g)

<sup>b</sup>The postneonatal mortality rate is defined as the number of infants between 28 days and 1 year old who die per 1,000 infants surviving the neonatal period (i.e., first 28 days after birth)

SOURCE Office of Technology Assessment 1988, calculated from the 1980 National Infant Mortality Surveillance Project, Preliminary Tables, Centers for Disease Control, Public Health Service, U S Department of Health and Human Services, Atlanta, GA, May 1986

# OTA's Derivation of the Estimate of the Population of Children Without Health Insurance<sup>1</sup>

As noted in chapter 3, the Current Population Survey (CPS) overestimates the population of children without health insurance because it does not directly ask about whether they have health insurance coverage through a noncustodial parent. Rather, if a parent responds that he or she has a policy that also covers the children, the CPS editing routine records a yes or no response for private health insurance. Consequently, children who are covered by a private policy bought by a parent who does not live in the household, such as a noncustodial divorced parent, are incorrectly listed as uninsured.

Although it is impossible to precisely adjust the estimates for this problem, one can estimate roughly how many children are in this position by using the April 1984 CPS.<sup>2</sup> The April 1984 CPS had a supplemental questionnaire for women with children under 21 years of age from absent fathers. On the basis of this survey, the U.S. Bureau of the Census estimated that there were 8,690,000 women ( $\pm 190,000$ ) who had custody of children under the age of 21 from absent fathers. A quarter of these women had married again and would be indistinguishable from women who had been married only once on the March CPS—i.e., their marital status in March would be “married.”

Among all the women with children from an absent father, 3,995,000 (46 percent) were supposed to receive child support payments in 1983, but only 3,037,000 (35 percent) actually received the payments. Thus, just over a third of all women with children under 21 years of age from an absent father received child support payments in 1983. Of the women who actually re-

ceived child support payments, just over half had health insurance included in the child support award or agreement (1,641,000). On average, these women had about 1.8 children, or about 2,954,000 children under 21 years of age altogether nationwide.

In 1984, 59.1 percent of all children under 21 were 12 years old or younger, so for this age group, about 1,746,000 children had health insurance from absent parents. An unknown percentage of these children would have been reported as uninsured, when in fact they had insurance through their child custody agreements. If the child had no other source of insurance but that of the absent parent, then the CPS would have shown him or her to be uninsured.

On the basis of the information just presented, OTA calculated a lower bound on the percentage of children who were without health insurance. According to the March 1984 CPS, 7,873,000 children between 0 and 12 years of age—18 percent of all children in that age group—were uninsured. If one assumes that none of the 1,746,000 children with health insurance through child custody agreements had other sources of insurance, then the actual number of children age 12 or younger who did not have health insurance would be 6,127,000 ( $7,873,000 - 1,746,000$ ), 14 percent of the total 0- to 12-year-old population in 1984. Since 6,127,000 is 78 percent of 7,873,000, the lower bound estimate of the number of uninsured children 0 to 12 years old in 1984 is 78 percent of the number reported by the CPS.

Applying this figure (78 percent) to the 1986 CPS data on insuredness of children gives a lower bound estimate of the percentage of children without health insurance in 1986 of 14 percent. The upper bound estimate, taken directly from 1986 CPS data, is 19 percent. Thus, OTA estimates that the true percentage of children between 0 and 12 years of age who were without health insurance in 1986 lies somewhere in the range of 14 to 19 percent.

<sup>1</sup>This appendix is based on a background paper prepared for OTA by Katherine Swartz (631).

<sup>2</sup>The information that follows comes from Child Support and Alimony 1983 (Supplemental Report 1), *Current Population Reports*, Special Studies, Series P-13, No. 148 by the Bureau of the Census, U.S. Department of Commerce, Washington, DC, 1986.

# Physician Participation in Medicaid

---

## Issues in Measuring Physician Participation

A question raised in chapter 3 was whether the current Medicaid payment levels are so low as to seriously jeopardize the availability of physicians willing to serve pregnant women and children covered by Medicaid. If acceptable access is defined as the ability of the Medicaid patient to find a qualified doctor within reasonable time and distance, not necessarily one of the patient's own choosing, participation in Medicaid by all physicians is not necessary. Yet it is difficult to measure the extent to which Medicaid patients are able to find qualified physicians to serve them.

Ideally, Medicaid patients' ability to find a participating physician should be measured directly. In fact, however, most of what is known about physician participation is based on national surveys of physicians, the most recent one conducted in 1984 (5,430,431,489,593). These surveys generally ask individual physicians two questions: 1) whether they participate in Medicaid, and 2) what share of their total practice is devoted to Medicaid patients.

Both of these questions are inadequate. A positive response on overall participation masks potentially major differences among physicians in their true involvement in the Medicaid program. A physician who has enrolled and obtained a Medicaid provider number but who rarely sees Medicaid patients, for example, may consider himself or herself to be participating, when in fact he or she has virtually no involvement in the program. The circumstances under which the low Medicaid patient load occurs may also affect one's judgment about participation. Suppose the physician will accept all Medicaid patients into his or her practice but is located in an area with so few Medicaid recipients that none are served. Which is the appropriate measure, the physician's willingness to participate or the actual treatment of patients?

The use of practice share as a measure of participation is also troublesome, especially when it is used to show national trends in physician participation. Practice share can be influenced by changes in the number of Medicaid eligibles, the size of the non-Medicaid population, and the number of physicians. As the number of eligibles decreases and the number of physicians increases, one would expect practice shares to decrease even in an environment of full participation. Conversely, as the number of participating physicians de-

creases, practice shares of those remaining to serve Medicaid patients would be expected to increase.

Another problem in interpreting the data is the frequent reliance on self-reported estimates taken from surveys of physicians rather than on objective data on the physician's actual patient population. Physicians appear to overestimate their participation in Medicaid. One study of pediatricians found that, on average, these physicians reported that they devoted a considerably greater percentage of visits to Medicaid patients than was indicated by actual patient records (i.e., 13.0 percent for self-reports v. 7.7 percent for patient records) (343). In another survey of California physicians conducted in 1974 by the California Medical Association, about 43 percent of physicians indicated that they "probably would" accept a new Medicaid patient, 19.9 percent "might" accept a new patient, 24.6 percent "probably would not," and 12.4 percent "definitely would not" accept a new Medicaid patient (310). Shortly after the results of that survey were published, the results of a somewhat less scientific poll conducted by the Office of the California State Auditor General<sup>1</sup> were published (724). These results suggested that only those physicians who said they "probably would" accept a new Medicaid patient probably would.

The fact that physicians tend to greatly overestimate their Medicaid participation suggests that survey data based on physicians' self-reports must be interpreted with a great deal of skepticism.<sup>2</sup> On the other hand, there is no reason to suspect that the upward bias in self-reporting of participation would change over time or systematically vary across specialties or geographic regions. Therefore, time-trend and comparative analysis based on physician surveys provides reasonably valid information on changes or differences in access to care among Medicaid populations.

## Evidence on Physician Participation in Medicaid

Recent national surveys of Medicaid participation by physicians in pediatrics, obstetrics/gynecology (*OB/GYN*), and other specialties are summarized in

<sup>1</sup>This survey was based on calls to random physicians from purportedly new Medicaid patients looking for a physician.

<sup>2</sup>For a more detailed discussion of reasons for inaccuracies in self-reported surveys, see "Medicaid Participation by Pediatricians and Obstetricians," prepared for OTA by P. McMenamin (418)



table E-1 (5,430,431,489,593). Since the data in table E-1 are all survey-based, the reported rates of participation and reported practice shares devoted to Medicaid patients are very likely overstated. Adjusting the practice share estimates by the ratio between actual practice share and reported practice share found by Kletke, et al. (343)—i.e., 0,5894—yields a mean practice share of 9.8 percent for pediatricians and 5.9 percent for OB/GYNs in 1984. There is no similar adjustment factor available for the willingness-to-participate measure, so that measure of participation cannot be adjusted.

Information on pediatricians' participation in Medicaid from a 1978 American Academy of Pediatrics survey is presented in table E-2 (127). Pediatricians were asked two questions: 1) whether they were accepting new non-Medicaid patients, and 2) if so, whether they were accepting all new Medicaid patients. Those who answered yes to both questions were considered to be "full participants" in the Medicaid program. Wide differences in these rates were found among the 13 States included in the survey.

Table E-3 summarizes data available from a survey by the Health Care Financing Administration and National Opinion Research Corp. on Medicaid partici-

pation of OB/GYNs by region in 1978 and 1984. That table shows substantial regional variation in rates of reported participation. Furthermore, it indicates a reversal in rankings of the regions between 1978 and 1984. In 1978, the Northeast had the second highest OB/GYN Medicaid participation rate; in 1984, it had the lowest. Data from the 1984 survey by the Health Care Financing Administration and National Opinion Research Corp. also show that rural areas have higher OB/GYN participation rates than urban areas. Whereas 85 percent of OB/GYNs not located in Standard Metropolitan Statistical Areas (SMSAs) reported participating in Medicaid, only 70 percent of OB/GYNs located in SMSAs reported participating.

The data presented in tables E-1 to E-3 allow several observations:

- OB/GYNs lag behind other specialties in Medicaid participation, and pediatrician participation is about average among the specialties.
- OB/GYN participation increased modestly over time between 1978 and 1984.
- Pediatrician participation increased slightly between 1978 and 1984.
- There exists substantial regional variation in Medicaid participation rates of OB/GYNs; this vari-

**Table E-1.—Survey-Based Data on Recent Trends in Medicaid Participation, by Physician Specialty**

Specialty	Percentage of physicians who participate					Percentage of participating physicians' practice share devoted to Medicaid patients			
	1976a	1978 <sup>b</sup>	1983C	1983d	1984e	1976 <sup>a</sup>	1978b	1983 <sup>d</sup>	1984e
All physicians .....		76.5			82.8	11.9	9.1		
Pediatrics .....	73.6	76.9		82	81.5	10.8	14.1	14.7	16.7
Obstetrics/gynecology .....	60.0	64.4	46		72.2	9.7	8.4		10.0
General practice .....	71.4	75.1	67		80.4	11.6	13.1		10.6
Family practice .....			67		86.8				10.6
Internal medicine .....	66.5	79.8			80.4	7.9	13.2		7.6
Cardiology .....		68.1			85.5		6.9		6.3
Other medical specialties .....					84.3				7.1
General surgery .....	73.9	90.3			87.1	11.5	13.4		11.6
Orthopedic surgery .....		81.4			88.3		9.8		6.8
Ophthalmology .....		82.0			87.0		13.2		6.4
Urology .....		88.9			92.9		3.2		9.1
Other surgical specialties .....					82.5				6.9
Psychiatry .....		57.8			60.0		8.0		5.9
Anesthesiology .....					97.2				9.3
Pathology .....					91.9				7.9
Radiology .....					94.2				8.9
Other specialties .....					84.7				10.0

<sup>a</sup>F A Sloan, J Cromwell, and J B Mitchell, *Private Physicians and Public Programs* (Lexington, MA: D C Heath & Co., 1978) Survey question 1 in the last week, what percentage of visits were with Medicaid patients?

<sup>b</sup>J B Mitchell and R Schurman, Access to Private Obstetrics/Gynecology Services Under Medicaid *Medical Care* 22(11) 1026-1037, 1984

<sup>c</sup>Alan Guttmacher Institute Physician Survey 1983, unpublished data on physician participation in Medicaid New York, NY, 1983 Survey question 1 in your private practice, do you accept Medicaid reimbursements for deliveries?

<sup>d</sup>J D Perloff, P R Kletke and K M Neckerman, "Trends in Pediatrician Participation in State Medicaid Programs," *Medical Care* 24(8) 749-760, 1986

<sup>e</sup>J Mitchell Health Care Financing Administration/National Opinion Research Corporation Physician Practice Costs and Income Survey 1984.85 unpublished data, Center for Health Economics Research Chestnut Hill MA, 1986

SOURCE Office of Technology Assessment 1988

**Table E-2.— Percentage of Pediatricians Considered “Full Participants” in Medicaid, by State, 1978**

	Percentage of pediatricians considered full participants
Massachusetts . . . . .	100%
Nebraska . . . . .	94
Colorado . . . . .	87
Georgia . . . . .	85
Oklahoma . . . . .	85
Indiana . . . . .	80
California . . . . .	78
Iowa . . . . .	76
Maryland . . . . .	68
Texas . . . . .	61
New York . . . . .	60
Tennessee . . . . .	59
Pennsylvania . . . . .	32

<sup>a</sup>Full participants were physicians who said that they were accepting new non-Medicaid patients and were also accepting all Medicaid patients.

SOURCE S. Davidson, J. Perloff, P. Kletke, et al., “Medicaid Participation: Full and Limited Participants,” *Pediatrics* 72:552-559, 1983. Reproduced by permission.

ation appears to have grown in the 6 years between 1978 and 1984.

- Rural areas have higher OB/GYN participation rates than urban areas.

The modest improvement over time in OB/GYN participation in Medicaid is consistent with recent trends in the supply of physicians in this specialty relative to the demand for their services. Table E-4 shows that both the ratio of OB/GYNs to Medicaid women and to the total number of births in the United States increased between 1978 and 1984. The increasing supply of physicians would, all other things remaining the same, encourage increased participation in Medicaid. In addition, table E-4 shows that the ratio of participating OB/GYNs to Medicaid women has increased dramatically (by 39 percent) in the period 1978 to 1984 (due in part to reductions in the size of the Medicaid population caused by eligibility limitations imposed in the early 1980s).

Trends in physician participation in Medicaid since 1984, while unmeasured, may not have continued in the same direction. Increases in the cost of running a practice discourage physicians from serving a Medicaid population with low fees. In the past 5 years, all physicians, but particularly OB/GYNs, have experienced rapid increases in malpractice insurance premiums. Between 1983 and 1985, the average cost of physician

**Table E-3.—Regional Variations in OB/GYN Medicaid Participation Rates, 1978 and 1984**

	Percentage of OB/GYNs who participate		Mean percentage of practice share devoted to Medicaid patients	
	1978a	1984b	1978 <sup>a</sup>	1984b
Northeast . . . . .	66.20/o	62.20/o	8.6	7.3
North Central . . . . .	69.2	82.9	9.6	11.8
South . . . . .	60.4	71.0	6.2	9.6
West . . . . .	63.1	81.8	10.9	14.2
Total . . . . .	64.40/o	72.20/o	8.40/o	10.00/0

<sup>a</sup>Data from J. B. Mitchell and R. Schurman, “Access to Private Obstetrics/Gynecology Services Under Medicaid,” *Medical Care* 22(11): 1026-1037, 1984. <sup>b</sup>J. Mitchell, “Health Care Financing Administration/National Opinion Research Corporation, Physician Practice Costs and Income Survey 1984-85,” unpublished data, Center for Health Economics Research, Chestnut Hill, MA, 1986.

SOURCE “Office of Technology Assessment, 1988

**Table E-4.—Ratio of OB/GYNs to Female Medicaid Recipients and to Total Number of Births, 1978 and 1984**

	OB/GYNs per 1,000 female Medicaid recipients (15-44 yrs) <sup>a</sup>			Participating OB/GYNs per 1,000 female Medicaid recipients (15-44 yrs) <sup>b</sup>			OB/GYNs per 1,000 births in the United States	
	1978	1984	% increase 1978-84	1978	1984	% increase 1978-84	1978	1984
Total United States . . . . .	4.30	5.30	230/o	2.80	3.90	39%	7.2	7.3
Northeast . . . . .	4.33	6.59	520/o	2.87	4.10	420/o	10.1	10.1
North Central . . . . .	4.52	4.53	0%	3.13	3.76	20%	6.0	6.5
South . . . . .	4.54	5.18	14 %/0	2.74	3.67	34%	6.8	7.0
West . . . . .	3.88	5.02	290/o	2.44	4.10	680/0	6.9	6.7

<sup>a</sup>Data on ratio of OB/GYNs to female Medicaid recipients from J. B. Mitchell and R. Schurman, “Access to Private Obstetrics/Gynecology Services Under Medicaid,” *Medical Care* 22(11): 1026-1037, 1984; and J. Mitchell, “Health Care Financing Administration/National Opinion Research Corporation, Physician Practice Costs and Income Survey: 1984-85,” unpublished data, Center for Health Economics Research, Chestnut Hill, MA, 1986.

<sup>b</sup>Data on ratio of OB/GYNs to total number of births from American Medical Association, *Physician Characteristics and Distribution in the U.S.: 1984 Edition* (Chicago, IL, 1985); American Medical Association, *Physician Characteristics and Distribution in the U.S.: 1979 Edition* (Chicago, IL, 1980); U.S. Department of Commerce, Bureau of the Census, *Statistical Abstract of the U.S. 1986* (Washington, DC 1985); U.S. Department of Commerce, Bureau of the Census, *Statistical Abstract of the U.S. 1979* (Washington, DC 1979).

SOURCE “Office of Technology Assessment, 1988

malpractice insurance doubled (650). The cost of malpractice insurance premiums for all physicians went from 3 to 4 percent of average gross income between 1982 and 1984; for OB/GYN-s, malpractice insurance premiums increased from 5 percent to 8 percent of average gross income during that period, and for pediatricians, they stayed the same at 2 percent (650). Other things being equal, the rapid increase in costs of malpractice insurance unaccompanied by fee increases from Medicaid, should have a deleterious effect on participation. How the opposing forces of increased physician supply and increased practice costs play out in terms of physicians' willingness to serve Medicaid patients today is an empirical question that cannot be answered at present.

Data from California do provide some limited insights into access of Medicaid patients to private pediatric and obstetrical practices in the period 1981 to 1985 (418). The number of pediatricians' practices that actually received Medicaid payments per 1,000 eligible Medicaid children (under 21 years of age) in California remained stable from 1981 to 1985, and the number of OB/GYN practices receiving Medicaid payments per 1,000 eligible women between 15 and 44 years old actually increased slightly in that period (see table E-5). These data suggest that access to care in private practice did not decline markedly in the 1981 to 1985 period, at least in California (418).<sup>3</sup> So, while

<sup>3</sup> These results are not inconsistent with a reduction in the actual number of participating practices (defined here as practices actually receiving payments from Medicaid) in the State during that time period, because the number of eligibles decreased during the period as well. In fact, the number of OB/GYN participating practices declined from 1,867 to 1,719 from 1981 to 1985, while the number of participating pediatrics practices increased from 1,469 to 1,633. The greatest part of the decline in participating OB/GYN practices in California occurred in just two counties, however (418).

**Table E-5.—California Physician Practices Receiving Medicaid Payments per 1,000 Eligibles, 1981-85**

	1981	1982	1983	1984	1985
Pediatrician practices per child 20 years or younger . . . . .	1.15	1.24	1.24	1.20	1.22
OB/GYN practices per eligible female aged 15 to 44 . . . . .	2.73	2.86	2.92	2.71	2.80

SOURCE: State of California, Department of Health Care Services, Medical Care statistics Unit, unpublished statistics on physician practices receiving Medicaid payments, Sacramento, CA, 1986

Medicaid patients' access to private care may be limited, the available evidence to date suggests that it has not deteriorated badly over the past 5 years in the State as a whole, despite deterioration in the relative fees paid by Medicaid and increases in practice costs.

To summarize, the available information on physician participation in Medicaid is limited and largely insufficient to address the question of access. Because of the high interstate and interregional variation in physician participation, it is very likely that some populations of Medicaid recipients are without access to private obstetrical and pediatric services, while others are able to obtain qualified services.

# Ambulatory Tocodynamometry

---

## Introduction

About 8 percent of all live births in the United States, on the order of **300,000** per year, occur before 37 weeks of gestation. A large percentage of these premature, or preterm, babies are of low birthweight, accounting for roughly half the low birthweight babies born each year. Many of these infants require intensive care, some will die in their first month or year of life, and some will have permanent disabilities as a result of their premature birth. Ambulatory tocodynamometry is designed as an aid to secondary prevention, an “early warning system” for detecting preterm labor, with the hoped-for effect of greater success of stopping early labor from progressing to an immediate birth.

The ambulatory tocodynamometer has an electronic sensor (a resistance strain gauge of sorts) that detects uterine contractions through the wall of the abdomen. The device is worn by a pregnant woman, strapped on with a belt. Signals from the device are stored in an attached recorder and later transmitted by telephone line to be plotted on a paper strip so the pattern of activity can be interpreted by a nurse or other trained professional. If preterm labor is diagnosed more than about 4 weeks before the due date (full term considered to be **36** weeks gestation), attempts to stop the labor can be made, assuming there are no medical reasons for the pregnancy to end early. How well tocodynamometry will play a part in averting preterm births still is unsettled, though information is accumulating as studies of the device are completed. There remain considerable uncertainties about the appropriate use of ambulatory tocodynamometry in clinical practice, though current information suggests that it may be effective under certain conditions. Whatever the clinical usefulness of ambulatory tocodynamometry, it is clear that research about the natural history of uterine activity in pregnancy, normal and abnormal, could benefit greatly from the information-gathering abilities of the device.

The underlying causes and events precipitating most cases of preterm labor are not well understood, and attempts at primary prevention of preterm labor—avoiding or averting its occurrence at all—have been, by and large, unsuccessful. It is possible, however, to identify some women who have a high likelihood of the premature onset of labor, based on their previous obstetric history and some characteristics of their current pregnancy. The preexisting conditions that set

apart women at high risk for preterm labor include preterm labor or preterm birth in a previous pregnancy and certain abnormalities of the uterus. In the current pregnancy, an initial episode of preterm labor, twin (or higher multiple) pregnancy, cervical dilation, and “uterine irritability” (excessive uterine activity, not necessarily with full, high-amplitude contractions characteristic of labor) indicate a high risk of preterm labor. Many episodes of preterm labor and subsequent preterm births occur among a much larger pool of women without those specific risk factors. Clinically, ambulatory tocodynamometers have been used mainly by the former group of women—those with known risk factors. There has also been interest in developing a means to use the devices for identifying women from the larger group who are likely to experience preterm labor.

Another strategy that addresses the problem of preterm labor and might be placed in the category of tertiary prevention—trying to prevent or minimize untoward consequences of preterm labor—is the aggressive treatment of premature infants. Although large gains have been achieved through neonatal intensive care, the margin for further improvements is shrinking, and the already high costs are still rising.<sup>1</sup>

## Strategies for Stopping Preterm Labor

The tocodynamometer itself is an information-generating technology that can be used to diagnose preterm labor in early stages, and its potential for improving the outcomes of preterm labor depends entirely on the availability of interventions to alter the natural course of events. Studies adequate to characterize the efficacy and safety of nearly all the available “tocolytic,” or labor-stopping, interventions are lacking, though some approaches appear to be more effective than others.

One of the impediments to evaluating tocolytic interventions has been the fact that women do not readily recognize the very early stages of labor, when it is generally believed that the process is most amenable to intervention (Newman, Gill, Wittreich, et al., 1986). Once significant physical change in a woman's

---

<sup>1</sup> For information on the costs and effectiveness of neonatal intensive care units (NICUs) see ch. 2 and OTA's 1987, case study entitled *Neonatal Intensive Care for Low Birthweight Infants: Costs and Effectiveness* (U. S. Congress, OTA, 1987).

cervix occurs, a preterm birth may be unavoidable, given the current, available tocolytic strategies.

The idea for using ambulatory tocodynamometry developed out of the apparent success in certain highly motivated women of “self-palpation” of the uterus to detect contractions before the women would normally become aware of them. The aim was to shift the detection of labor to an earlier point when successful long-term tocolysis is thought to be more likely. The disappointing overall success rates of tocolysis, as reported in the literature, stem from a combination of the low probability of stopping labor in advanced stages and the effectiveness of the interventions. Using tocodynamometry in studies of tocolytic interventions could help clarify the effects of the interventions themselves when conditions appear more favorable for success. The discussion of tocolytic interventions presented here reflects the current literature and the experience with these techniques as they have been used generally.

The idea of intervening to stop the course of premature labor, or to prevent its occurrence entirely, is not new, and a number of pharmacologic and physical approaches have been tried over the years. Hydration is usually tried, with or without other measures. Some classes of pharmacologic agents—e.g., tranquilizers, spasmolytics, opiates, anesthetic agents—are no longer considered to be effective. There still is some minor interest in ethanol and hormonal agents (e.g., progesterone) for stopping preterm labor. Estrogen, in the form of diethylstilbestrol (DES), was at one time considered useful (on the theory that estrogen deficiency was the cause of preterm labor), but this substance is no longer used. The earliest approach to attempt prevention of preterm births, and one still current despite a lack of evidence of efficacy, is bedrest. Cervical cerclage, a surgical procedure which was introduced about 40 years ago in which the mouth of the cervix is physically cinched together with a suture, also is still used, though its popularity has waned.

### Tocolytic Drugs

Beta-mimetic drugs and magnesium sulfate are the most recent, and probably the most effective, drug interventions for stopping labor. Ritodrine hydrochloride, a beta-mimetic, is the only drug approved by the U.S. Food and Drug Administration (FDA) for the inhibition of uterine contractions in threatened preterm labor. Developed specifically for this use and tested in clinical trials (including randomized trials) during the 1970s, ritodrine was approved in 1980, one of a small number of drugs approved in recent years for use during pregnancy (Barden, Peter, and Merkatz,

1980). Another beta-mimetic, terbutaline, a commonly prescribed bronchodilator used by asthmatics, is widely used for tocolysis, though it has not been approved for that indication.

Beta-mimetic drugs act by altering the cascade of events that leads to contraction. “Receptors” on the surface of smooth muscle cells play a role in mediating the ionic balance of the cells, including the influx and outflow of calcium ions, which are instrumental in the events leading to muscle contraction. Ritodrine and terbutaline selectively stimulate receptors that predominate in uterine muscles—“beta<sub>2</sub> receptors”—although they also affect the “beta<sub>1</sub> receptors” of the heart muscle and other organs. Stimulation of the beta<sub>1</sub> receptors results in quickening of the heart beat, one of the major side effects of beta-mimetic drugs. All beta-mimetics may stimulate a wide range of organ receptors, which may cause severe adverse effects on the cardiovascular system.

A recent overview of randomized trials of beta-mimetic drugs concluded that they can be effective in halting preterm labor in the short term—e.g., for 24 to 72 hours—but there is insufficient evidence from those trials to conclude anything about their efficacy in the longer term (King, Keirse, Grant, et al., 1985). Part of the problem in interpreting those trials to understand the potential of the tocolytic agents used is that in most women, preterm labor is far advanced before it is recognized, and tocolysis fails. The pertinent question with the use of tocodynamometry is whether tocolytics will, as is often assumed, be more effective overall when preterm labor is diagnosed in earlier stages. Randomized clinical trials of the tocodynamometry/tocolysis combination will be required to adequately characterize the safety and effectiveness of this approach. Potential negative effects include overdiagnosis of preterm labor, resulting in unnecessary tocolytic treatment, and treatment of women in whom preterm labor would resolve spontaneously.

### Bedrest and Cervical Cerclage

In the realm of strategies to avoid the onset of preterm labor, at least one randomized trial has been conducted of hospital bedrest. That study compared hospital bedrest against hospitalization as needed from 32 weeks of gestation for women with twin pregnancies. Hospital bedrest conferred no benefit at all in preventing the occurrence of preterm labor. In fact, preterm deliveries were more common among women in the group randomized to compulsory hospitalization than among women in the ambulatory group (Saunders, Dick, Brown, et al., 1985). Despite this negative finding and no reliable positive studies, routine bedrest still is commonly prescribed.

The first randomized clinical trial of cervical cerclage was published in 1984 (Lazar, Gueguen, Dreyfus, et al., 1984). Because cervical cerclage has been so widely accepted by obstetricians for women with a high-risk profile for premature delivery due to cervical incompetence, the trial included only women at “moderate” risk. In the end, the rate of preterm births was no different in the cerclage and the control groups. The trial had two important results. First, it provided clear evidence that cervical cerclage was not effective in reducing the rate of preterm births among women at average risk. Second, it raised enough doubt about the usefulness of the procedure to plan a further trial of cervical cerclage in women at high risk.

Women at high risk of preterm delivery were recruited for the second randomized trial of cervical cerclage (Rush, Isaacs, McPherson, et al., 1984). The findings parallel those of the first trial. No evidence of benefit, either in lowering the preterm delivery rate or improving survival, was detected. In several ways, women with cerclage fared worse than those without, having longer hospital stays (excluding the time spent in hospital for the cerclage itself), receiving more tocolytic drugs, and having more fevers (though the latter two differences were not significant statistically).

It still is possible that cerclage may be beneficial to a specific group of women with cervical incompetence, but its use has not been so limited. Further studies may elucidate an appropriate role for this procedure.

### **Risk Factors for Preterm Labor and Preterm Birth Prevention Programs for High-Risk Women**

Certain factors have been identified that set apart women at high risk for preterm labor, some of the factors present before the pregnancy and some related to what is experienced during the pregnancy. Preexisting risk factors, some being stronger predictors than others, include: preterm labor in a previous pregnancy, uterine anomalies, being a “DES daughter” (a woman exposed in utero to the drug DES during her mother’s pregnancy), and previous spontaneous or therapeutic abortions. Risk factors associated with the pregnancy itself include: twin (or higher multiple) pregnancy (also called “multiple gestation”), arrested preterm labor in the current pregnancy, and recurring uterine “irritability,” or infection. (There also are sociodemographic factors that seem to be associated with a higher risk of preterm birth—e.g., teenage low-income women are more likely to experience preterm labor—but these factors are not such strong predictors on an individual basis.)

Using this type of information, investigators have developed risk scoring scales to identify women at high risk of preterm labor. The French obstetrician Dr. Emile Papiernik developed such a scale in the late 1960s, and he applied it in an area of France in a broad-based educational program aimed at bringing down the rate of preterm births during the early 1970s. Although the success of particular aspects of the French program could not be evaluated independently, the preterm birth rate did drop gradually over a 12-year period from 5.4 to 3.7 percent. That drop suggests the possibility of influencing the preterm birth rate (Papiernik, Bouyer, Dreyfus, et al., 1985); however, other factors might have been changing over time as well, and the change cannot be clearly attributed to any particular factor.

In the late 1970s, Dr. Robert Creasy, who built on Papiernik’s scoring system, introduced the first preterm birth prevention program in the United States based on self-detection of uterine contractions (Heron, Katz, and Creasy, 1982). That program laid the groundwork for ambulatory tocodynamometry. Specifically, Creasy and his colleagues used a risk scoring method, which included both medical and socio-demographic factors, to divide their population of patients into low- and high-risk groups. Women in the high-risk group were educated about the early signs and symptoms of preterm labor and were taught the technique of self-detection of painless contractions by palpating the uterus. These women had weekly cervical monitoring at a special clinic. The clinic staff also had special training and education to optimize their responses to the women in the program and to recognize the subtle symptoms seen at the onset of preterm labor. The low-risk women got their usual obstetric care. No controlled studies were carried out in conjunction with this program,

During the first year of the program, **24 (2.5 percent) of the 974 low-risk and 30 (17 percent) of the 176 high-risk women entered labor prematurely (before 36 weeks gestation). Beta-mimetic drugs were given to most of the women (those who had not progressed beyond specific stages of labor and for whom there were no contraindications for continuing the pregnancy) with final results of full-term deliveries for 23 of the high-risk women and for 15 of the low-risk women who had experienced preterm labor.**

The overall preterm birth rate (including those women who had intentional preterm deliveries for medical reasons) during 1979, the year after the program was initiated, was 2.4 percent. The preprogram **1977 rate was 6.75 percent.** The authors also reported that the annual rates from 1977 through 1979 at an

affiliated institution remained above 6.5 percent. While no causal inferences could be drawn because there was no control population, it is possible that the program accounted for some or all of the change. In any case, the generalizability of results from the program is limited because the population enrolled was a self-selected, highly motivated group of women.

The positive result of this program, however, was to spur the initiation of a randomized trial of the Creasy program at five institutions around the country, sponsored by the March of Dimes. The results of this study are not yet available.

### Development and Current Use of Ambulatory Tocodynamometry

The ambulatory tocodynamometer is intended as an adjunct to a preterm birth prevention program such as Dr. Creasy's. This device should be more reliable than self-detection of early labor and would allow women to stay at home when they otherwise might be hospitalized or have emergency room or office visits. Three such devices have been developed in the United States. One, TermGuard<sup>®</sup>, made by the Tokos company, was developed by Dr. Michael Katz, who was a fellow of Dr. Creasy's, and the other devices were developed by the Litton and Healthdyne companies. All three ambulatory devices are considered "substantially equivalent" to hospital-based stationary tocodynamometers that have been marketed since the 1950s, and the manufacturers have obtained FDA clearance on that basis. Currently, these devices cannot be advertised as being effective for use in detecting preterm labor or in preventing preterm births, but only for detecting uterine activity, the function of the stationary devices. The Tokos company is seeking FDA approval to market TermGuard<sup>®</sup> with a claim that the device prevents preterm births, based on completed and ongoing clinical trials. On the basis of current approval, however, thousands of pregnant women have been monitored over the past few years, most with Tokos' equipment.

Although there are differences in the capabilities of the three brands of tocodynamometer, the most important difference among them is in the way they are marketed. While the Litton device is sold to be used by independent practitioners or institutions, Tokos' TermGuard<sup>®</sup> is marketed not simply as a device, but as a service, to be prescribed by doctors. (Healthdyne has followed Tokos' lead, though it is quite new to the market.) Once the service has been prescribed, nurses employed by Tokos at special centers interact with patients, teaching them how to monitor, talking to them each day, and receiving their monitoring transmis-

sions. In general, patients on the Tokos system are asked to monitor twice daily for an hour at a time, during which time they may move around. With the "sensor" strapped on, uterine activity is detected, and the electronic signals are stored in the attached recorder. During telephone contact, the daily signals are sent to the nursing center over an ordinary phone line and printed out on a graphing tape, similar to the printout in a hospital setting. The pattern of low- and high-amplitude contractions is interpreted immediately after transmission by a trained perinatal nurse.

Tokos nurses confer with the prescribing physicians to define criteria for notifying them of unusual uterine activity and to inform them of when those criteria are met. The notification criterion is typically four or more contractions in an hour. Following notification, the doctor decides on the appropriate action. If preterm labor is confirmed by physical examination (a finding of cervical effacement), intervention with a tocolytic agent may be prescribed.

Tokos does not currently sell its devices and therefore retains considerable control over how they are used. Litton does not offer such a service and sells its devices (including the monitors, recorders, and readout units) outright. Most have been bought by hospitals, private physicians, and private companies.

Tokos currently operates 30 nursing centers around the United States and 1 in France. Since 1984, more than 10,000 women have been monitored, an average of 53 days each and at a cost of about \$75 per day. As of October 1987, 10 State Medicaid programs had approved tocodynamometry for coverage (not all had set reimbursement rates) and most of the major private insurance companies, including several Blue Cross/Blue Shield plans, provided some coverage, primarily for patients who have had preterm labor stopped and been sent home from the hospital with the device.

### Studies of the Effectiveness of Tocodynamometry

The first studies of ambulatory tocodynamometry as part of a program for women at high risk of preterm delivery were carried out, as is often the case with new technologies, by the device's proponents, including one of its developers. These early studies, which did have control groups but which did not use random allocation, had very positive results: significant numbers of preterm births were avoided and no unintended adverse effects were found. They also answered affirmatively some basic questions about the practicality of ambulatory tocodynamometry—e.g., can

uterine activity patterns be accurately and reliably transmitted over existing phone lines?

So far, few studies of ambulatory tocodynamometry in clinical practice have been completed, so available evidence on which to judge the effectiveness of the technique is limited. In general, however, findings from the more recent studies have been more modest. All of the studies reviewed here involve the Tokos service or a similar set of services, so the results cannot be interpreted as strictly attributable to the device itself. In particular, there is a suggestion that the daily contact between the pregnant women and the Tokos nurses that is included in the service may account for at least part of the benefit found in earlier studies. Other differences in results among studies may be explained at least in part by other factors, including underlying differences in study populations, e.g., in the definitions of "high risk," in the effective use of tocolytic interventions by physicians, and in the treatments given to the "control" groups.

The first report of ambulatory tocodynamometry was published in August 1985 (Katz and Gill, 1985). The authors aimed to answer basic questions about the device itself (TermGuard<sup>®</sup>, Tokos Medical Corp.) and the information it provides. First, do TermGuard readings correlate with readings from stationary external uterine activity monitors with regard to the frequency of contractions? Second, do TermGuard external readings correlate well with readings from internal uterine pressure catheters in measuring intrauterine pressure, a measure of intensity, during contractions? And last, can the device be used successfully by a pregnant woman at home? Those questions were all answered in the affirmative.

Questions about the overall effectiveness of tocodynamometry in preventing preterm birth have been addressed in later studies, with more mixed results, though generally positive findings. None of the studies to date, however, has been free of major design flaws or been large enough to give results that are unequivocal.

The first published evaluation of ambulatory tocodynamometry as part of a program to prevent preterm births, carried out by the device's developers and proponents, appeared in December 1986 (Katz, Gill, and Newman, 1986). The study reports the experience of 76 women at very high risk of having a pre-term birth as judged by their past obstetric history or the existence of uterine anomalies. The birth outcomes for these women were compared with those of a group of 76 women who were matched on risk factors, parity, and age. Most of the women (87 percent of monitored and 82 percent of unmonitored) were given instruction about the signs of preterm labor and were

taught to palpate themselves for uterine activity. About half the women in both the monitored and unmonitored groups went into preterm labor. All women in preterm labor, except those with extreme cervical dilation, were treated with intravenous ritodrine; then, if tocolysis was successful, they were switched to oral ritodrine or terbutaline. Overall, 67 of the 76 monitored women (88 percent) had deliveries at or beyond 37 weeks; 45 of the 76 unmonitored women (59 percent) reached at least 37 weeks.

In March 1987, a controlled study of ambulatory tocodynamometry was reported (Morrison, 1987).<sup>2</sup> The study compared the Tokos system (34 women) with self-palpation (33 women) for monitoring uterine activity in a group of women at very high risk of having a preterm delivery. Only women with one of the following risk factors were eligible for entry into the study: 1) multifetal gestation (meaning twin or higher multiple pregnancy), 2) uterine abnormalities, or 3) history of two or more preterm births. (These criteria are more stringent than those used in the earlier studies, resulting in a higher overall rate of preterm labor in the study population.)

The tocodynamometry group wore monitors to record uterine activity twice daily for an hour at a time, and both groups were instructed about the signs and symptoms of preterm labor. Women in the tocodynamometry group had regular daily contact with Tokos' nurses, and those in the self-palpation group, twice weekly. All women were advised to call if they had symptoms of preterm labor.

Overall, the results favored ambulatory tocodynamometry over self-palpation: 18 of the 33 women in the self-palpation group, and 29 of the 34 women in the group with tocodynamometers, carried their pregnancies to term. About two-thirds of the women in each group (22 in the self-palpation group and 24 in the Tokos group) had a diagnosis of preterm labor, but more of the self-palpation women were farther along in the course of labor than were the Tokos women at the time of diagnosis. The investigators attribute the difference in overall outcome largely to the greater success of tocolytic intervention (most with magnesium sulfate, and a few with ritodrine hydrochloride) in the Tokos women because they were treated in earlier stages of labor. Although this is a relatively small study, the results are quite striking and appear to represent a positive effect of the Tokos system, though the true size of the effect cannot be estimated reliably.

<sup>2</sup>Although the study is described as "randomized," in fact, it was not. Women were allocated to one group or the other according to whether the last digit of their hospital numbers were odd or even. Whether this affected the results is unknown.



A second study comparing the Tokos system with self-palpation appeared in September 1987 (Iams, Johnson, O'Shaughnessy, et al., 1987). The advantage of this study is that the self-palpation group had a level of contact with the Tokos nurses similar to that of the tocodynamometry group, so the difference in the interventions was narrowed as much as possible to the device itself. The following risk factors qualified women for entry into the study: 1) previous preterm delivery, 2) twin pregnancy, 3) previous second trimester loss, 4) cervical cerclage in this pregnancy, 5) uterine anomaly or DES daughter, and 6) bleeding after 14 weeks of pregnancy. The report states that 157 women were randomly allocated<sup>3</sup> in a ratio of 1:2 to either education and self-palpation (50 women, referred to as group E) or education and tocodynamometry (107 women, referred to as group EM).

The two groups had similar rates of preterm labor (about 37 percent of the women), and the progress of labor was not generally farther along in group E women than it was among group EM women when it was diagnosed. The rate of preterm birth was about the same in each group (20.4 percent before 35 weeks gestation in group E, and 23.5 percent in group EM), and there were no significant differences in the rate of successful tocolysis, gestational age, birthweight, or days gained from first preterm labor to delivery between the two groups.

The conclusion from this study in this group of patients is that tocodynamometry and self-palpation, both accompanied by intensive nursing support, produced about equal rates of preterm birth in a high-risk population. Because there was no group without intervention, the size of the effect relative to no intervention cannot be estimated directly. The investigators concluded that the role of "frequent and supportive patient contact in preterm birth prevention" should be given greater attention, and further that "the role of ambulatory contraction monitoring has yet to be defined." The finding of no major difference in outcome between the two groups is difficult to interpret because of the lack of a true control. The study does, however, point out the need to clarify what elements of monitoring—those centering on the device versus those centering on the interaction between the patient and provider—make a difference, as well as which women are most likely to benefit from monitoring.<sup>4</sup>

Results of a third study of ambulatory tocodynamometry in high-risk women who have not yet had an episode of preterm labor in the current pregnancy

were presented at the 1987 meeting of the Society of Perinatal Obstetricians (Porto, Nageotte, Hill, et al., 1987).<sup>5</sup> In this study, high-risk women were randomly assigned to one of three groups. Groups 1 and 2 were supplied with Tokos monitors and taught to use them, and the third group had no special intervention. The first two groups had daily contact with the Tokos nurses and transmitted their recorded data to the Tokos center, but the data were used to manage only group 1. For group 2, data were not used for patient management. A total of 136 patients were entered in the trial, 44 in group 1, 46 in group 2, and 46 in group 3. The investigators excluded "noncompliant" women from the analysis (3 women from group 1 and 4 women from group 2). The results indicated a similar rate of preterm labor in all three groups, but a lower rate of preterm deliveries in groups 1 and/or 2 compared with group 3 (reaching conventional levels of statistical significance). The analysis was based on small numbers of preterm births, however (4 in group 1, 6 in group 2, and 11 in group 3), and the exclusion of the noncompliant women may well have had an effect on the analyses. It is not possible to draw strong conclusions from this study.

### Using Tocodynamometry To Screen for Women at Increased Risk of Preterm Labor

"Risk scoring" methods exist to identify women with a high probability of delivering a preterm baby. Some of the risk factors that go into these systems are discussed above. While a high percentage of the identified high-risk group will have preterm labor and go on to a preterm delivery, the group that can be so identified is small, and in fact, approximately half of all preterm births are to women not so identified, but who are part of a much larger pool with a lower overall risk of preterm birth. One potential use for the ambulatory tocodynamometer is as a method to "screen" for women likely to proceed to preterm labor but who have no specific risk factors. Three studies comparing high-amplitude uterine contraction patterns (the type of contractions that occur at short intervals during labor and delivery) of women who experienced first spontaneous labor preterm, at term, and postterm, were presented at the 1987 annual meeting of the Society of Perinatal Obstetricians.<sup>6</sup> Another recent study looked at patterns of low-amplitude contractions (which, when occurring frequently, are termed "uter-

<sup>3</sup>The method of randomization is not given.

<sup>4</sup>A methodologic problem with the study is that six women dropped out of the study from group E and nine from group EM, and these women were excluded from the analysis; their exclusion could have biased the results, though it is impossible to say whether this is the case.

<sup>5</sup>Abstract only available.

<sup>6</sup>The randomization scheme was not specified.

<sup>7</sup>All available as abstracts only.

ine irritability"). One study in the first group (Main, Katz, Chiu, et al., 1987) took a practical screening approach in which uterine activity of a group of low-risk women was followed—measured with an ambulatory tocodynamometer for 1 hour once a week at a clinic between **27 and 34 weeks gestation**. The tracings were read by individuals with no knowledge of the women's status, and after the deliveries took place, the tracings were analyzed according to the two groups into which these women fell: 1) those who experienced preterm labor (less than 37 weeks gestation), and 2) those who had spontaneous labor for the first time at term (**37 or more weeks gestation**). As early as 28 weeks gestation, the group of women who would go on to preterm labor had a higher average number of contractions per hour than did the rest of the women, but the ranges of uterine activity between the two groups overlapped considerably. According to the investigators, 12 of the 17 women who developed preterm labor would have been identified by a criterion of five or more contractions in an hour anytime between **28 and 32 weeks gestation**. It would also have incorrectly picked out **34** of the 108 women who labored at term.

One of the other studies focused on a population of women with known risk factors for preterm labor who used ambulatory tocodynamometry as prescribed, monitoring for an hour twice daily (Tomasi, Eden, Canlas, et al., 1987). Distinct differences in uterine contraction patterns, beginning at about **29 weeks gestation**, were found in the group of women who would experience preterm labor compared with the group who would go on to term or later.

Little detail was given about the population studied in the third report, but the data support a general trend toward increased uterine activity among women who will experience preterm labor several weeks before labor actually begins (Nageotte, Dorchester, Porto, et al., 1987).

A study of low-amplitude contractions (Newman, Gill, Campion, et al., 1987) was undertaken because these contractions occurring at high frequency, a condition called "uterine irritability," are considered a risk factor for preterm labor. In this study, 92 women at high risk of preterm labor and 50 at low risk were monitored with the Tokos system. The authors found that, in fact, many women who experienced low-amplitude contractions for a relatively high proportion of the time (more than **30 percent** of the time) did enter labor prematurely. For a number of women, preterm labor was not preceded by that pattern, however. Those who demonstrated this pattern less than 10 percent of the time were much more likely to have term labor. Although the findings are of clinical and biologic in-

terest, the authors concluded that a pattern of high-frequency, low-amplitude contractions could not be used as a screening technique because, overall, such a finding was not highly predictive of preterm labor.

## Net Health Care Costs of Tocodynamometry

It is relatively easy to develop a simple model to determine the net monetary costs of ambulatory tocodynamometry, but it rests on a major assumption about the level of effectiveness of the device and associated services in reducing the frequency of preterm delivery. Basically, the costs of monitoring a group of women must be balanced against the savings in neonatal care for the percentage of women whose pregnancies are prolonged. Costs of monitoring can be measured directly, and savings can be measured as the average costs of treating preterm babies in neonatal intensive care units (NICUs). The preterm birth rates in different groups of women and the success rate for arresting preterm labor must be estimated from data from the few comparative studies of tocodynamometry that have been carried out and from other women who have been monitored. Net costs would decrease the more "efficiently" tocodynamometry were used, i.e., the larger the percentage of women in the monitored group who experience preterm labor, the greater the benefit would be. With a low rate of preterm labor, many more women would be monitored than would benefit, making a greater contribution to the cost side than to the savings side.

The following example uses data from Tokos' clinical experience (Tokos, 1987) and from studies of women at high risk of preterm labor and preterm delivery. Among a group of women who either have had a previous preterm delivery, have a uterine anomaly, or have a multifetal gestation, about 40 percent would be expected to have a preterm delivery, given accepted obstetric practice in the United States. About 30 percent would be expected to experience preterm labor, of whom **80 to 90 percent** would go on almost immediately to a preterm delivery. The remaining 10 to 20 percent would extend their pregnancies by an average of about 4 weeks. Of those with no preterm labor, about 20 percent would have an intentional delivery before term.

In this example, the Tokos service could potentially extend the pregnancies of women who experience preterm labor, but for whom tocolysis would be too late without tocodynamometry (the **80 to 90 percent** of 30 percent), and also extend for more than 4 weeks the pregnancies of those 10 to 20 percent (of the original

30 percent) whose labor would have been successfully stopped initially without Tokos. The effectiveness data, which come largely from nonrandomized studies and the patient files of the Tokos Medical Corp., currently are inadequate to select a number with confidence, but the existing data are consistent with a reduction in the overall preterm delivery rate from about 40 percent to about 25 percent. This reduction is assumed in the following analysis.

Net health care costs for society would be equal to the difference between the total cost of monitoring high-risk women and the savings resulting from reduction in the care required for the extra 15 percent of deliveries that would be carried to term as a result of the program. Using average figures, the cost of monitoring 100 women (for an average of 53 days at \$75 per day) would be \$397,500. The cost avoided for caring for the 15 babies brought to term, had they been born instead at the time of preterm labor, can be considered a savings. Costs include not only the extra care needed around the time of birth, but also some excess hospital readmission during the first year of life particularly and the long-term costs of caring for the proportion of preterm babies with lifelong handicaps due to prematurity. In addition to direct costs to society, families may bear extra emotional and financial costs at the birth of a premature baby, particularly one with severe disabilities.

Using data from the State of Maryland, OTA estimates the extra cost of hospital care for each preterm baby (assuming that all would have weighed less than 2,500 grams at birth) at between \$3,763 and \$5,236.<sup>7</sup> Extra initial physician costs are estimated at between \$475 and \$1,487 per baby. Rehospitalization costs in the first year of life are an estimated \$802 extra per preterm baby. The estimated cost of long-term care per low birthweight baby (up to age 35) is between \$9,000 and \$23,000. Based on these figures, the monetary cost of each low birthweight birth, therefore, totals between \$14,040 and \$30,525.<sup>8</sup> The potential savings in delaying 15 births (from the original 100 above) would be between \$210,600 and \$457,875, so there may or may not be a cost-saving when compared to the \$397,000.

<sup>7</sup>The figures for initial and first-year costs used in this analysis are based on data from the State of Maryland. See ch. 4 of this report for details. Details of the long-term care costs are given in app. G. Hospital and physician costs are given in 1986 dollars.

<sup>8</sup>The figures are not charges, but estimates of resource costs. Many analyses of the costs of caring for preterm babies have been based on actual charges, which may be considerably higher than resource costs, thus altering the balance in a cost analysis. OTA's analysis, from the societal point of view, is more appropriately based on costs. The distribution of birthweights at 28 to 31 weeks gestation was taken from U.S. national vital statistics for 1985 (U.S. DHHS/PHS 1987). A weighted average hospital cost per preterm birth was derived by allocating birthweight-specific costs by the proportion of births at 28 to 31 weeks in each birthweight category.

In a complete analysis, several other costs must be considered, some of which would fall on the net cost side and others on the saving side. Extra costs would be incurred for women treated for preterm labor detected initially through tocodynamometry, in whom the labor would not otherwise have been detected and which would not have progressed to an immediate birth. The potential rate of such "false positive" diagnosis is not known at present. Hospitalization for initial tocolysis, plus oral tocolysis after discharge would be included. Potential adverse effects of tocolytic agents on the mother and/or fetus, which currently are poorly known, might also eventually become costly in dollars and certainly have human costs.

An additional benefit of tocodynamometry, which might result in cost savings, is the possibility of discharging women from the hospital on oral tocolytic agents earlier than they might otherwise be. In this case, the tocodynamometer may be used to calibrate the tocolytic dose and give feedback on uterine activity otherwise available only while the woman is hospitalized. It is possible also that women who have had a successfully arrested episode of preterm labor may be able to return home on ambulatory tocodynamometry, rather than be hospitalized for the remainder of the pregnancy.

## Summary

As a machine, the ambulatory tocodynamometer must be seen as a valuable information-generating technology. It provides reliable information about the activity of the uterus during pregnancy. It has already increased knowledge about that activity in its use as a research tool. The machine does not, however, allow interpretation of the information it produces in a way that would provide a definite diagnosis of preterm labor. As more experience with the device is gained, using the information for diagnosis should improve. The most uncertain part of all is deciding on a course of action once preterm labor is detected, presumably early in its course, with daily tocodynamometry. Certain drugs appear to be effective in stopping labor from proceeding to delivery, but the evaluations have been spotty. Part of the difficulty in testing interventions in the past has been that most women are not aware that labor has begun until it has progressed to a point that it cannot be stopped. Interventions have been attempted anyway, mostly unsuccessfully. Older studies, in which most women were treated far along in labor, may not be relevant to the use of tocolytic interventions with early detection. Until there is a direct demonstration of the effectiveness of early tocolysis in a program that uses tocodynamometry, however, the actual value of the system cannot be judged.

Unfortunately, public sector research has focused almost entirely on learning about the natural history of labor, while the few intervention trials have been supported largely by manufacturers.

Ambulatory tocodynamometry may have the potential for significantly reducing preterm birth rates and perhaps saving money, if used in appropriate populations and if interventions are applied appropriately. It might also foster the development and evaluation of more effective means of tocolysis. The "ifs" cannot be taken as inevitable, however, and the consequences of the "if nets" include much greater use of tocolytic agents, with their known and unknown adverse effects, as well as potentially great cost. As more and more physicians use the Tokos service, and as more companies enter the market, the widespread dissemination of the ambulatory tocodynamometer may precede answers to questions about appropriate populations and about the use of tocolytic agents.

Tocodynamometry is still considered investigational by professional groups (e.g., the American College of Obstetricians and Gynecologists), and there are a large number of skeptics in the medical community. There is a pressing need for well-designed randomized trials of tocodynamometry in conjunction with the best tocolytic treatments available, across the sociodemographic spectrum of pregnant women at risk of preterm labor. Without additional careful studies soon, it may be impossible to place this device in its appropriate and rational niche.

## Appendix F References

- Barden, T. P., Peter, J. B., and Merkatz, I. R., "Ritodrine Hydrochloride: A Betamimetic Agent for Use in Preterm Labor," *Obstet./Gynecol.* 56(1):1-6, 1980.
- Herron, M. A., Katz, M., and Creasy, R. K., "Evaluation of a Preterm Birth Prevention Program: Preliminary Report," *Obstet./Gynecol.* 59:452-456, 1982.
- Iams, J. D., Johnson, F. F., O'Shaughnessy, R. W., et al., "A Prospective Random Trial of Home Uterine Activity Monitoring in Pregnancies at Increased Risk of Preterm Labor," *Am. J. Obstet. Gynecol.* 157:638-643, 1987.
- Katz, M., and Gill, P. J., "Initial Evaluation of an Ambulatory System for Home Monitoring and Transmission of Uterine Activity Data," *Obstet./Gynecol.* 66(2):273-277, 1985.
- Katz, M., Gill, P. J., and Newman, R. B., "Detection of Preterm Labor by Ambulatory Monitoring of Uterine Activity: A Preliminary Report," *Obstet./Gynecol.* 68(6):773-778, 1986.
- King, J. F., Keirse, M. J., Grant, A., et al., "Tocolysis—the Case for and Against," *Preterm Labour and Its Consequences*, R.W. Beard and F. Sharp (eds.) (London, England: Royal College of Obstetricians and Gynecologists, 1985).
- Lazar, P., Gueguen, S., Dreyfus, J., et al., "Multicentered Controlled Trial of Cervical Cerclage in Women at Moderate Risk of Preterm Delivery," *Br. J. Obstet. Gynaecol.* 91:731-735, 1984.
- Main, D. M., Katz, M., Chiu, G., et al., "Intermittent Weekly Contraction Monitoring To Predict Preterm Labor in Low Risk Women: A Blinded Study," abstract, paper presented at the annual meeting of the Society for Perinatal Obstetricians, Lake Buena Vista, FL, Feb. 5-7, 1987.
- Morrison, J. C., "Prevention of Preterm Birth by Ambulatory Assessment of Uterine Activity: A Randomized Study," *Am. J. Obstet. Gynecol.* 156: 536-543, 1987.
- Nageotte, M. P., Dorchester, W., Porto, M., et al., "Quantitation of Uterine Activity Preceding Preterm, Term and Postterm Labor," abstract, paper presented at the annual meeting of the Society for Perinatal Obstetricians, Lake Buena Vista, FL, Feb. 5-7, 1987.
- Newman, R. B., Gill, P. J., Campion, S., et al., "Antepartum Ambulatory Tocodynamometry: The Significance of Low-Amplitude, High-Frequency Contractions," *Obstet./Gynecol.* 70:701-705, 1987.
- Newman, R. B., Gill, P. J., Wittreich, P., et al., "Maternal Perception of Prelabor Uterine Activity," *Obstet./Gynecol.* 68:765-769, 1986.
- Papiernik, E., Bouyer, J., Dreyfus, J., et al., "Prevention of Preterm Births: A Perinatal Study in Haguenau, France," *Pediatrics* 76:154-158, 1985.
- Porto, M., Nageotte, M. P., Hill, O., et al., "The Role of Home Uterine Activity Monitoring in the Prevention of Preterm Birth," abstract, paper presented at the annual meeting of the Society for Perinatal Obstetricians, Lake Buena Vista, FL, Feb. 5-7, 1987.
- Rush, R. W., Isaacs, S., McPherson, K., et al., "A Randomized Controlled Trial of Cervical Cerclage in Women at High Risk of Spontaneous Preterm Delivery," *Br. J. Obstet. Gynaecol.* 91:724-730, 1984.
- Saunders, M. C., Dick, J. S., Brown, I. M., et al., "The Effects of Hospital Admission for Bed Rest on the Duration of Twin Pregnancy: A Randomised Trial," *Lancet* 2:793-795, 1985.
- Tokos Medical Corp., "Home Uterine Activity Monitoring and Perinatal Nursing Services," typescript, 1987.
- Tomasi, A. M., Eden, R. D., Canlas, V. M., et al., "Can Preterm Labor Be Predicted by Ambulatory Tocodynamometry?" abstract, paper presented at the annual meeting of the Society for Perinatal

Obstetricians, Lake Buena Vista, FL, Feb. 5-7, 1987.  
U.S. Congress, Office of Technology Assessment,  
*Neonatal Intensive Care for Low Birthweight  
Infants: Costs and Effectiveness*, OTA-HCS-38  
(Washington, DC: U.S. Government Printing Of-

fice, December 1987).  
U.S. Department of Health and Human Services,  
Public Health Service, National Center for Health  
Statistics, *Monthly Vital Statistics Report* **36(4)**  
(Suppl.), July 17, 1987.

# Background Information on Prenatal Care

---

## Introduction

This appendix is intended to supplement the information on prenatal care in chapter 4. It has two main parts:

- detailed descriptions of studies of the effectiveness and cost-effectiveness of prenatal care, and
- background data and information on methods underlying OTA's analysis of the cost-effectiveness of prenatal care.

## Studies of the Effectiveness and Cost-Effectiveness of Prenatal Care

Studies of the effects of prenatal care on birth outcomes fall into two general categories: 1) studies based on vital records (i. e., birth and death records); and 2) studies evaluating programs offering enriched or augmented prenatal care services.

The methods and findings of 26 studies that analyzed the effects of prenatal care using vital records collected by hospitals, cities, counties, States, and the Federal Government are summarized in table G-1. All of the studies shown in that table used multivariate or other techniques to control for demographic or medical risk factors that might influence birth outcomes independently of prenatal care.

In recent years, several investigators seeking to examine the effects of prenatal care on birth outcomes have applied econometric techniques—in particular, the instrumental variables method—to vital records data. Table G-2 summarizes five recent econometric analyses of the effects of prenatal care on neonatal mortality and birthweight. All five of the studies involved the application of the instrumental variables technique, a technique that is used to correct for adverse selection bias.<sup>1</sup> Studies using econometric techniques such as the instrumental variables method uniformly find even stronger negative effects of prenatal care on neonatal mortality and low birthweight than are found with traditional multivariate techniques.

<sup>1</sup>Adverse selection bias is a threat to the validity of some studies of the effectiveness of prenatal care. For more information on this and a related threat (favorable selection bias), see the section in ch. 4 entitled "Problems in Interpreting the Evidence." The instrumental variables technique attempts to correct for adverse selection bias by replacing the observed value of prenatal care with a predicted value derived from a regression of prenatal care on explanatory variables that are uncorrelated with the mother's health status; the predicted prenatal care level thus derived is also assumed to be uncorrelated with the mother's health status. The predicted level of prenatal care is then used in a second-stage regression analysis to predict its effect on the outcome of pregnancy.

Such studies generally do not adequately control for favorable selection bias, however, and therefore can be expected to overestimate the effects of prenatal care on birth outcomes.

Table G-3 summarizes 25 evaluations of the effects on birth outcomes of programs offering augmented prenatal care. Such programs typically serve teenagers or poor women. Evaluations of programs with augmented services often use well-selected comparison groups. However, such evaluations typically compare care that is generally available to women in the community with more comprehensive programs, and it is difficult to generalize from these studies about the value of more v. less prenatal care of the kind that is generally available.

Table G-4 summarizes 12 studies of the cost-effectiveness of prenatal care. The studies differ with respect to the target population studied, the alternatives compared, and the categories of costs included. Most important in distinguishing these studies from one another, however, is the perspective of the analysis (indicated in the second column of the table). Most of the 12 cost-effectiveness studies examine the net costs of a strategy to a particular institution (e. g., a health maintenance organization) or program (e. g., Medicaid). Differences between alternatives in costs to other segments of society (e. g., patients, providers, and insurance companies) are generally not calculated.

## Data and Methods Underlying OTA's Cost-Effectiveness Analysis of Expanded Medicaid Eligibility for Prenatal Care

In chapter 4, OTA analyzed the cost-effectiveness of expanding eligibility for Medicaid to all pregnant women in poverty. OTA's analysis relied on estimates of the cost of prenatal care and health care for low birthweight babies and the expected change in the use of early prenatal care resulting from the expansion of eligibility. This section elaborates on those two topics, first, with a description of the data sources, methods, and assumptions underlying the estimate of the long-term health care costs associated with a low birthweight birth; and second, with a summary of data on the impact of insurance coverage on the use of prenatal care by poor women.

**Table G-1.—Studies Using Vital Records To Examine the Effects of Prenatal Care on Birth Outcomes**

Author	Study year(s)	Research design	Prenatal care measure	Observed effects					
				Neonatal mortality			Birthweight		
				Whites	Blacks	Total	Whites	Blacks	Total
Kessner, et al., 1973'	1968	Retrospective analysis of live births in New York City controlling for race, ethnicity, social and medical risk	Adequacy of care index <sup>27, 28</sup>	+	+	+	+	+	+
Gortmaker, 1979'	1968	Reanalysis of Kessner, et al. (1973) data controlling for demographics (4 measures), medical conditions, hospital service (private v. general)	Modified adequacy of care Index	0	+		+	+	
Greenberg, 1983'	1977	Retrospective analysis of live births in the U.S. controlling for race and education	Some v no care				†		
Showstack, et al., 1985'	1978	Retrospective analysis of live births in 2 California counties controlling for demographics, hospital type, gestation	Modified adequacy of care index						
Strobino, et al., 1985'	1975-80	Retrospective analysis of change in neonatal mortality from 1976 to 1980 in Mississippi; race-specific decomposition of change in NMR into proportion attributed to new use of prenatal care v. proportion independent of changes in use	Number of visits Trimester in which care began	†	+29		0		
Institute of Medicine, 1985'	1981	Retrospective analysis of live births in the U.S. controlling for race, educational level, marital status, age/parity risk	1. First trimester v. other 2. First-trimester care with recommended number of visits by gestational age				+	+	
Fisher, et al., 1985'	1980-83	Retrospective analysis of births in low- and high-income census tracts in Washington State, 1980-83	Percent receiving late or no prenatal care						
Quick, et al., 1981'	1973-75	Retrospective analysis of live births in Portland, Oregon, controlling for sociodemographic and medical-obstetric risk and membership in HMO	Modified adequacy of care index				†		
Eisner, et al., 1979'	1974	Retrospective analysis of live births in the U.S. controlling for demographics and pregnancy history	Some v. no care				†	†	
Terris and Glassser, 1974'	1961	Life table analysis of demographically matched LBW and mature weight infants born to black mothers in New York City	Month care began					Mixed <sup>10</sup>	
Shwartz and Vinyard, 1965'	1960	Modified life table analysis of live births in Washington, DC, controlling for demographics and pregnancy complications	Onset of care in specific gestational age intervals						Mixed"
Elster, 1984'	1974-79	Retrospective analysis of live births in Utah controlling for demographics, pregnancy history, and maternal age	Trimester care began				† <sup>22</sup>		
Dott and Fort, 1975'	1972	Retrospective analysis of live births in Louisiana controlling for birthweight and poverty status	Number of visits						

**Table G-1.—Studies Using Vital Records To Examine the Effects of Prenatal Care on Birth Outcomes—Continued**

Author	Study year(s)	Research design	Prenatal care measure	Observed effects					
				Neonatal mortality			Birthweight		
				Whites	Blacks	Total	Whites	Blacks	Total
Schramm and Land, 1984 <sup>15</sup>	1981-82	Retrospective analysis of Missouri Medicaid births controlling for race, separate analysis for each year	Modified adequacy of care index	+	0	0	+	+	+
Ryan, Sweeny, and Solola, 1980 <sup>15</sup>	July-Dec. 1979	Retrospective analysis of live births in Memphis, Tennessee, hospital serving mainly low-income blacks; groups similar on most demographics and medical risk	Low (0-3) v. high (4+) number of visits			+			+
Terris and Gold, 1969 <sup>16</sup>	Not specified	Retrospective analysis of demographically matched pairs of LBW and mature weight black infants born in one Brooklyn, New York, hospital	Week of pregnancy at first Visit  Ratio of observed to expected/recommended number of visits by gestational age					0	0
Shwartz and Poppen, 1982 <sup>7</sup>	1981	Retrospective analysis of births in Baltimore, Maryland, controlling for demographics, medical-obstetric factors	Modified adequacy of care Index					+	
Grossman and Jacobowitz, 1981 <sup>18</sup>	1964-77	Retrospective county-level analysis of live births in the U. S., controlling for demographics, family planning and abortion use, prior mortality rates	Active non-Federal MDs/1,000 population  Medicaid coverage of first-time pregnancies	0	Mixed <sup>33</sup>				
Corman and Grossman, 1985 <sup>19</sup>	1964-77	Retrospective county-level analysis of live births in the U.S. controlling for demographics; availability of family planning, MIC Projects, CHCs and NICUs; WIC use	Medicaid coverage of first-time pregnancies	0	0				
Hadley, 1982 <sup>20</sup>	1969-73	Retrospective county group-level analysis of live births in the U.S. controlling for prior NMR, births to high-risk women, hospital births, Medicare expenditures, percent older and non-board-certified OBS, abortions and NICU	Number of OBS/1,000 live births  Medicaid coverage of unborn children	+	0				



**Table G-1.—Studies Using Vital Records To Examine the Effects of Prenatal Care on Birth Outcomes—Continued**

Author	Study year(s)	Research design	Prenatal care measure	Observed effects					
				Neonatal mortality			Birthweight		
				Whites	Blacks	Total	Whites	Blacks	Total
Goldman and Grossman, 1982 <sup>21</sup>	1969-78	Retrospective county-level analysis of live births in the U.S. controlling for percent nonwhite births, family income, availability of physicians	Presence and number of CHCs	Mixed	Mixed <sup>24</sup>	Mixed			
Corman, Joyce, and Grossman, 1987 <sup>22</sup>	1975-80	Retrospective county-level analysis of live births in the U.S. controlling for birthweight, abortion rate, NICU availability, teen family planning use, WIC use, BCHS project use, smoking behavior, high-risk women, percent poor	Percent of live births with first-trimester care	+	†				
Joyce, 1987 <sup>23</sup>	1976-78	Retrospective county-level analysis of live births in the U.S. controlling for birthweight, prematurity, teen family planning use, abortion use, NICU availability, smoking behavior, teen births, births to older women, high-risk women, population density	Percent of live births with first-trimester care	†	0		†	0	
Rosenzweig and Schultz, 1982 <sup>24</sup>	1980	Retrospective analysis of live births in the U.S. controlling for demographics, parity, smoking behavior, use of prenatal screening tests, and electronic fetal monitoring	1. Delay (in months) to first visit						0
			2a Delay (in months) to first visit						—
			2b. Total number of visits						+
Harris, 1982 <sup>25</sup>	1975-76	Retrospective analysis of fetal deaths and live births to black mothers in Massachusetts, maximum likelihood estimate of effect of prenatal care controlling for demographic and medical risk factors and gestational age	Trimester in which care began			—35		0	

**Table G-1.—Studies Using Vital Records To Examine the Effects of Prenatal Care on Birth Outcomes—Continued**

Author	Study year(s)	Research design	Prenatal care measure	Observed effects						
				Neonatal mortality			Birthweight			
				Whites	Blacks	Total	Whites	Blacks	Total	
Lewit, 1983 <sup>28</sup>	1970	Retrospective analysis of live births in New York City controlling for demographics and medical risk factors and gestational age	Delay in initiation of care							+3,
			Number of visits							+36

Abbreviations BCHS = Bureau of Community Health Services; CHC = community health center, LBW = low birthweight; MD = medical doctor; MIC = maternity and infant care; NICU = neonatal Intensive care unit, N M R = neonatal mortality rate, OB = obstetrician; WIC = Women, Infants, and Children

Key: + = positive effect (e.g., prenatal care improves the condition)

- = negative effect (e.g., prenatal care worsens the condition).

O = no effect (e.g. prenatal care has no impact on the condition)

Mixed = results were positive, negative, and/or nil.

Blank spaces mean the relationship was not analyzed.

<sup>1</sup>D Kessner, J. Singer, C Kalk, et al., "Infant Death: An Analysis by Maternal Risk and Health Care," *Contrasts in Health Status: Vol 1* (Washington, DC: Institute of Medicine, National Academy of Sciences, 1973).

<sup>2</sup>S L. Gortmaker, "Poverty and Infant Mortality in the United States," *Am. Sociological Review* 44 "280-297, 1979

<sup>3</sup>R.S. Greenberg, "The Impact of Prenatal Care in Different Social Groups," *Am. J. Obstet. Gynecol.* 145 "797, 1983.

<sup>4</sup>J. A. Showstack, M H Stone, and S.A. Schroeder, "The Role of Changing Clinical Practices in the Rising Costs of Hospital Care," *N Eng J Med* 313(19):1201-1207, 1985.

<sup>5</sup>D.M. Strobino, Y.J Kim, B E Crawley, et al., "Declines in Nonwhite and White Neonatal Mortality in Mississippi, 1975 -80," *Public Health Reports* 100(4) "417-427, 1985

<sup>6</sup>Institute of Medicine, *Preventing Low Birthweight* (Washington, DC: National Academy Press, 1985).

<sup>7</sup>E S Fisher, J P. LoGerfo, and J.R. Daling, "Prenatal Care and Pregnancy Outcome During the Recession: The Washington State Experience," *Am J. Public Health* 75(8):866-869, 1985

<sup>8</sup>J D Quick, M R Green ick, and K.J. Roghmann, "Prenatal Care and Pregnancy Outcome in an HMO and General Population' A Multivariate Cohort Analysis," *Am. J. Public Health* 71(4):381-390, 1981

<sup>9</sup>V E Isner, J V Brazie, M W Pratt, et al., "The Risk of Low Birthweight," *Am. J. Public Health* 69(9):887-893, 1979

<sup>10</sup>M. Terris and M. Glasser, "A Life Table Analysis of the Relation of Prenatal Care to Prematurity," *Am J Public Health* 64(9):869-675, 1974.

<sup>11</sup>S Schwartz and J.H. Vinyard, "Prenatal Care and Prematurity," *Public Health Reports* 80(3):237-248, 1965.

<sup>12</sup>A. B. Elster, "The Effect of Maternal Age, Parity, and Prenatal Care on Perinatal Outcome in Adolescent Mother," *Am J Obstet. Gynecol* 149(8):845-847, 1984

<sup>13</sup>A. B. Dott and A T Fort, "The Effect of Availability and Utilization of Prenatal Care and Hospital Services on Infant Mortality Rates," *Am. J. Obstet. Gynecol* 123(8):854-860, 1975.

<sup>14</sup>W. Schramm and G Land, "Prenatal Care and Its Relationship to Medicaid Costs," prepared under HCFA Grant No. 11-P-98305, State Center for Health Statistics, Division of Health, Missouri Department of Social Services, December 1984.

<sup>15</sup>G Ryan, P Sweeney, and A Sotola, "Prenatal Care and Pregnancy Outcome," *Am. J Obstet. Gynecol.* 137(8):876-881, 1980

<sup>16</sup>M Terris and E. Gold, "An Epidemiologic Study of Prematurity: Part II, Relation to Prenatal Care, Birth Interval, Residential History, and Outcome of Previous Pregnancies," *Am J. Obstet. Gynecol.* 103(3) :371-379, 1969

<sup>17</sup>R. Schwartz and P Poppen, *Measuring the Impact of CHC's on Pregnancy Outcomes* (Cambridge, MA: Abt Associates, Inc., Oct. 15, 1982).

<sup>18</sup>M Grossman and S Jacobowitz, "Variations in Infant Mortality Rates Among Counties of the United States: The Roles of Public Policies and Programs," *Demography* 18(4):695-713, 1981

<sup>19</sup>H. Corman and M. Grossman, "Determinants of Neonatal Rates in the U.S.," *J. Health Economics* 4:213-236, 1985.

<sup>20</sup>J Hadley, *More Medical Care, Better Health?* (Washington, DC: Urban Institute Press, 1982)

<sup>21</sup>F. Goldman and M Grossman, "The Impact of Public Health Policy: The Case of Community Health Centers," Working Paper No. 1020 (Cambridge, MA: National Bureau of Economic Research, November 1982).

<sup>22</sup>H Corman, T.J. Joyce, and M. Grossman, "Birth Outcome Production Functions in the U.S.," *J. Human Resources* 22(3):339-360, 1987

<sup>23</sup>T Joyce, "The Impact of Induced Abortion on White and Black Birth Outcomes in the United States," *Demography* 24(2):229-244, 1987

<sup>24</sup>M.R. Rosenzweig and T.P. Schultz, "The Behavior of Mothers as Inputs to Child Health: The Determinants of Birth Weight, Gestation, and Rate Of Fetal Growth," *Economic Aspects of Health*, V R Fuchs (ed.) (Chicago, IL: University of Chicago Press, 1982).

<sup>25</sup>J. E. Harris, "Prenatal Medical Care and Infant Mortality," *Economic Aspects of Health*, V.R. Fuchs (ed.) (Chicago, IL: University of Chicago Press, 1982).

<sup>26</sup>E. Lewit, "The Demand for Prenatal Care and the Production of Healthy Infants," *Research in Human Capital and Development* 3:127-181, 1983.

<sup>27</sup>3-category index measuring timing of first visit, number of visits by gestational age, and type of hospital service.

<sup>28</sup>White = native born whites only

<sup>29</sup>Blacks = nonwhites

<sup>30</sup>When gestational age differences were controlled, negligible differences were found in the initiation of care for mothers of all premature births and their mature comparisons. However, mothers of infants premature by weight and gestation tended to initiate care earlier than their comparisons, while mothers of infants premature by weight alone tended to begin care later than their comparisons.

<sup>31</sup>No association was found between lack of care and low birthweight for women with complications of pregnancy. Similarly, there was no association for women without complications prior to gestational week 36. A significant association was found among women with uncomplicated pregnancies who delivered after 35 weeks gestation, controlling for demographics.

<sup>32</sup>Effect adjusted for gestational age

<sup>33</sup>Of four regression models tested using different control variables, two were positive and significant; two were not.

<sup>34</sup>The significance of findings varied with the CHC variable and the regression model tested. Authors concluded that CHCS contributed to reductions in NMR

<sup>35</sup>Effect adjusted for gestational age. Prenatal care associated with improvement in Prematurity rate

<sup>36</sup>Effect on birthweight independent of effect through gestational age

SOURCE Office of Technology Assessment, 1988

**Table G-2.—Econometric Studies of the Effectiveness of Prenatal Care<sup>a</sup>**

Author	Study year(s)	Unit of analysis	Prenatal care measure	Observed effects					
				Neonatal mortality			Birthweight		Total
				Whites	Blacks	Total	Whites	Blacks	
<b>Corman Joyce and Grossman 1987<sup>b</sup></b>	<b>1975-80</b>	Counties	1 Race-specific 3-yr average percent live births for which care began in first trimester centered on 1977 2 MIC project patients and female CHC users/ 1,000 poor women	- .016 to - .076 <sup>g</sup>	<b>.026 to</b> 1.17q				
Joyce 1987 <sup>c</sup>	1976-78	Counties	Percent of births receiving prenatal care in first trimester	-.047 <sup>g</sup>	NS		0.61 <sup>h</sup>	.045 <sup>g</sup>	
<b>Rosenzweig and Schultz 1982<sup>d</sup></b>	<b>Married subsample of the 1980 National Natality Survey</b>	Individual	1 Delay (in months) to first visit 2a Delay (in months) to first visit 2b. Total number of visits						1 One month additional delay reduces birthweight by 40 grams 2a NS 2b. Average increase in birthweight of 246 to 263 grams per visit
<b>Rosenzweig and Schultz 1986<sup>e</sup></b>	Married subsample of the 1980 National Natality Survey	Individual	Delay in months to first visit						One month additional delay reduces birthweight by 91 grams
Schultz, 1986 <sup>f</sup>	Married subsample of the 1980 National Natality Survey	Individual	1 Delay (in months) to first visit 2 Total number of visits						1 NS 2. 287 to 33 grams increase per visit

Abbreviations CHC = community health center, MIC = maternity and infant care, NMR = neonatal mortality rate. NS = not significant.

<sup>a</sup>The studies summarized in this table analyzed vital records data using the instrumental variables technique

<sup>b</sup>H.Corman, T. J. Joyce, and M. Grossman. "Birth Outcome Production Functions in the the U S," *J Human Resources* 22(3) 339-360, 1987

<sup>c</sup>Joyce. "The Impact of Induced Abortion of White and Black Birth Outcomes in the United States," *Demography* 24(2) 229-244, 1987

<sup>d</sup>M.R. Rosenzweig and T. p. Schultz. "The Behavior of Mothers as Inputs to Child Health: The Determinants of Birth Weight, Gestation, and Rate of Fetal Growth" *Economic Aspects of Health*, V. R. Fuchs

(ed.) (Chicago IL: University of Chicago Press, 1982)

<sup>e</sup>M. R. Rosenzweig and T. p. Schultz. "The Stability of Household Production Technology: A Replication," Center Discussion Paper No 511, Economic Growth Center, Yale University, New Haven, CT, September 1986

<sup>f</sup>T.P. Schultz. Unpublished data from the 1980 National Natality Survey. prepared for the Office of Technology Assessment, U S Congress, Washington, DC, July 1986

<sup>g</sup>Predicted percentage point change in NMR resulting from each percentage point increase in percent of mothers receiving early prenatal care

<sup>h</sup>Predicted percentage point change in low birthweight rate resulting from each percentage point increase in percent of mothers receiving early prenatal care

SOURCE Office of Technology Assessment, 1988

**Table G-3.—Studies of the Effects of Programs Offering Augmented Prenatal Care<sup>1</sup> on Birth Outcomes**

Author	Study year(s)	Research design	Prenatal care measure	Observed effects						
				Neonatal mortality			Birthweight			
				Blacks	Whites	Total	Blacks	Whites	Total	
Peoples and Siegel, 1983 <sup>2</sup>	1970-77, MIC project m North Carolina	Retrospective analysis controlling for demographics, reproductive risk, adequacy of care <sup>23</sup>	MIC v comparison group (all residents of three similar nonprogram countries)				(Teens) <sup>27</sup>			—
Sokol, et al 1980 <sup>3</sup>	1976-77, MIC project m Cleveland Metropolitan General Hospital, Ohio	Comparison of program participants and similar patients ineligible due to county of residence	MIC v comparison group							†
Johnson and Hefferin, 1977 <sup>4</sup>	1969-71, MIC project m Los Angeles County, California	Retrospective univariate analysis of demographically similar groups	MIC v traditional health department clinic users							0
Peoples, et al , 1984 <sup>5</sup>	1979-81, IPO project m North Carolina	Retrospective analysis controlling for demographics and reproductive risk	IPO counties/registrants v non-I PO counties/registrants				0			
Strobino, et al , 1986 <sup>6</sup>	1975-81, ICHP in Mississippi	Pre-post retrospective analysis controlling for demographics and reproductive risk	ICHP counties v non-ICHP counties				0 <sup>27</sup>	0		0
State of California, 1984, and Korenbrot, 1984 <sup>7</sup>	1978-82, OB Access project m California	Retrospective analysis of demographically matched groups	OB Access births v matched Medic-Cal births							†
Papiernik, et al 1985 <sup>8</sup>	1971-82 Haguenuau, France	Time-series analysis of rates of change in program area, controlling for maternal age, blood pressure, and social class	Births in study area where special program was implemented							†
Herron, et al 1982 <sup>9</sup>	1978-79 University of California, San Francisco Medical Center	Comparison of incidence of preterm delivery in program hospital v nonprogram hospital	Preterm labor prevention program for high risk UCSF v affiliated institution without special program							+33
Burt, et al 1984 <sup>10</sup>	1982, 38 projects sponsored by OAPP	Retrospective analysis and informal comparisons controlling for demographics	Participation in OAPP projects v other similar programs or national data							†
Moore, et al 1986 <sup>11</sup>	1981-84, University of California, San Diego Medical Center	Comparison of groups with similar demographics and medical risks	'No care v program participants							†
Smith et al 1978 <sup>12</sup>	1970-74 Jefferson Davis Hospital, Houston, Texas	Program participants randomly selected from hospital's obstetrical clinic comparison group matched on race, age, parity month of delivery	Teenage program participants v non-participants							†

**Table G-3.—Studies of the Effects of Programs Offering Augmented Prenatal Care<sup>1</sup> on Birth Outcomes—Continued**

Author	Study year(s)	Research design	Prenatal care measure	Observed effects							
				Neonatal mortality			Birthweight				
				Blacks	Whites	Total	Blacks	Whites	Total		
Olds et al 1986 <sup>13</sup>	1975-80 semi-rural county in Appalachian region of New York	Randomized clinical trial	Nurse-visited v comparison								+ (Teens) 0 i Smokers) Mixed <sup>29</sup> l Older nonsmokers )
Ershoff et al 1982 1983 <sup>14</sup>	1980-81 southern California HMO	Pre-post design with two comparison groups, separate covariate analyses for demographics	Routine care v care and education services								0 (Total) Mixed <sup>30</sup> (smokers)
Leppert, Namerow, and Barker 1986 <sup>15</sup>	1981-82 large urban teaching hospital New York City	Retrospective analysts controlling for demographics complications of pregnancy	Number of visits								†
University Associates, 1985 <sup>16</sup>	1984-85 11 local health departments in Michigan	Retrospective analysis of demographically similar groups	Number of visits								†
			Trimester at which care began								0
			Outcome of prior pregnancy compared to outcome of pregnancy while enrolled in program for same women				0		+		+
			Program participants v non-participants								†
Fence et al 1981 <sup>17</sup>	1974-78, University of Maryland Hospital, Baltimore Maryland	Retrospective analysis of matched pairs in terms of age race parity and socioeconomic status	Young teen users of comprehensive clinic v regular clinic users								†
McAnarney et al 1978 <sup>18</sup>	1972-73 3 settings in Rochester New York	Retrospective analysis of groups matched for race and public assistance status	Comprehensive maternity project for teens v a CHC v a hospital obstetrics clinic								

**Table G-3.—Studies of the Effects of Programs Offering Augmented Prenatal Care<sup>1</sup> on Birth Outcomes—Continued**

Author	Study year(s)	Research design	Prenatal care measure	Observed effects					
				Neonatal mortality			Birthweight		
				Blacks	Whites	Total	Blacks	Whites	Total
Grossman and Jacobowitz 1981 <sup>19</sup>	1964-77 MIC projects throughout the U S	Retrospective county-level analysis controlling for demographics, family planning and abortion use prior mortality rates	Presence of MIC projects and number of births to participants as percent of births to poor women	0	0				
Corman and Grossman 1985 <sup>20</sup>	1964-77 MIC projects throughout the U S	Retrospective county-level analysis controlling for demographics, availability of family planning abortion and NICUs; WIC use Medicaid eligibility	Number of MIC projects and CHCs per 1,000 poor women	Mixed <sup>21</sup>	Mixed <sup>21</sup>				
Corman, Joyce, and Grossman 1987 <sup>22</sup>	1975-80, U S	Retrospective county-level analysis controlling for birthweight, abortion and NICU availability teen family planning use, WIC use, smoking behavior, high-risk women, percent poor	MIC project patients and CHC female users per 1 000 poor women	Mixed <sup>22</sup>	Mixed <sup>22</sup>				
Shapiro, et al , 1958 <sup>22</sup>	1955 New York City	Retrospective analysis controlling for race, SES, maternal age	Prepaid group practice (HIP) v private practice patients	0 <sup>27</sup>	+		0		
Shapiro et al 1960 <sup>23</sup>	1955-57, New York City	Retrospective analysis controlling for race, SES, maternal age	Augmented prepaid group practice (HIP) v private practice patients	+27	+		+		
Rivara et al 1985 <sup>24</sup>	1970-78 Kentucky	Pre-post with comparison group, two groups similar on socioeconomic risk factors, standardized NMRs by birthweight birth multiplicity and infant gender	Regionalized perinatal care program counties v comparison counties						
Heins et al 1983 <sup>25</sup>	1976-78, South Carolina	Retrospective analysis, all participants were low income, high risk	Regionalized perinatal care program participants v nonparticipants						0
McCormick et al 1985 <sup>26</sup>	1970-79 eight regions	Pre-post with comparison group having similar demographics	Eight regionalized perinatal care program regions v eight comparison regions						0

Abbreviations HIP = Health Insurance Plan of New York City, an HMO, HMO = health maintenance organization ICHP = Improved Child Health Project, IPO = Improved pregnancy outcomes. LBW = low birthweight, MIC = maternity and infant care, NICU = neonatal intensive care unit NMR = neonatal mortality rate OAPP = Off Ice of Adolescent Pregnancy program. OB = obstetrician  
 SES = socioeconomic status, UCSF = University of California San Francisco

KEY + = positive effect (e.g. comprehensive program improves the condition)  
 - = negative effect (e.g., comprehensive program worsens the condition)  
 O = no effect (e.g., comprehensive program has no impact on the condition)  
 Mixed = results were positive, negative and/or nil  
 Blank spaces mean the relationship was not analyzed

<sup>1</sup>Augmented care includes programs which provide supplemental services in addition to prenatal medical care. These programs provided one or more of the following types of special services: outreach, transportation, nurse home visitation, nutrition and social services, health education, followup of missed appointments, case management/coordination of services, and dental care. Eligible participants were usually adolescents and/or low income or medically indigent women. Target areas varied in size also. Comparison groups typically received a more limited range of services.

<sup>2</sup>M D Peoples and E Siegel, "Measuring the Impact of Program for Mothers and Infants on Prenatal Care and Low Birth Weight: The Value of Refined Analyses." *Medical Care* 21(6) 586-605, 1983

<sup>3</sup>R J Sokol, R B Woolf, M G Rosen, et al "Risk, Antepartum Care, and Outcome: Impact of a Maternity and Infant Care Project." *Obstet./Gynecol* 56(2) 150-156 1980

<sup>4</sup>D K Johnson and E A Hefferin, "Perinatal Outcomes Among High-Risk Patients in Two Prenatal Care Programs." *Inquiry* 14:293-302, 1977

<sup>5</sup>M D Peoples, R C Grimson, and G L Daughtry, "Evaluation of the Effects of the North Carolina Improved Pregnancy Outcome Project: Implications for State-Level Decision Making." *Am J Public Health* 74(6) 549-554, 1984

<sup>6</sup>D M Stroblino, G A Chase, Y J Kim, et al, "The Impact of the MISSISSIPPI Improved Child Health Project on Prenatal Care and Low Birthweight." *Am J Public Health* 76(3) 274-278, 1986

<sup>7</sup>State of California, Health and Welfare Agency, Department of Health Care Services. "Final Evaluation of the Obstetrical Access Pilot Project. July 1979-June 1982." Sacramento, CA 1984, and C C Korenbrot, Risk Reduction in Pregnancies of Low-Income Women, " *Mobius* 4(3):35-43, 1984

<sup>8</sup>E Papiernik, J Bouyer, J Dreyfus, et al, "Prevention of Preterm Births: A Prenatal Study in Haguenau, France." *Pediatrics* 76(2) 154-158, 1985.

<sup>9</sup>M A Herron, M Katz, and R K Creasy, "Evaluation of a Preterm Birth Prevention Program: Preliminary Report." *Obstet./Gynecol* 59:452-456, 1982

<sup>10</sup>M R Burt, M H Kimmich, J Goldmuntz, et al *Fle/p/rig Pregnant Adolescents. Outcomes and Costs of Service Delivery* (Washington, DC: Urban Institute Press, February 1984)

<sup>11</sup>T R Moore, W Origel, T C Key, et al, "The Perinatal and Economic Impact of Prenatal Care in a Low-Socioeconomic Population." *Am J. Obstet/Gynecol* 154(1) 29-33, 1986

<sup>12</sup>P B Smith, R B Wait, D M Mumford, et al "The Medical Impacts of an Antepartum Program for Pregnant Adolescents: A Statistical Analysis." *Am J Public Health* 68(2) 169-172 1978

<sup>13</sup>D L Olds and C R Henderson, "Improving the Delivery of Prenatal Care and Outcomes of Pregnancy: A Randomized Trial of Nurse Home Visitation." *Pediatrics* 77(1) 16-28, 1986.

<sup>14</sup>D H Ershoff, N K Aaronson, B G Danaher, et al **Cost-Benefit Analysis of a Comprehensive Prenatal Health Education Program Within an HMO Setting. Executive Summary**, prepared for the Off Ice of Health Information, Health Promotion and Physical Fitness and Sports Medicine, Public Health Service, U S Department of Health and Human Services, Washington, DC, July 1982, and D H Ershoff, N K Aaronson, B G Danaher, et al., "Behavioral, Health, and Cost Outcomes of an HMO Based Prenatal Health Education Program." *Public Health Reports* 98(6) 536-547, 1983

<sup>15</sup>P C Leppert, P B Namerow, and D Barker, "Pregnancy Outcomes Among Adolescent and Older Women Receiving Comprehensive Prenatal Care." *J Adol Health Care* 7(2) 112-117, 1986.

<sup>16</sup>University Associates, *Infant Health Initiative Program Final Report*, prepared for the Bureau of Community Services, Michigan Department of Public Health (Lansing, MI December 1985)

<sup>17</sup>M E Fence, J L Granados, I G Ances, et al "The Young Pregnant Teenager: Impact of Comprehensive Prenatal Care." *J Adol Health Care* 1(3) 193-197, 1981

<sup>18</sup>E R McNamee, K J Roghmann, B N Adams, et al "Obstetric Neonatal and Psychosocial Outcomes of Pregnant Adolescents." *Pediatrics* 61(2) 199-205 1978

<sup>19</sup>M Grossman and S Jacobowitz, "Variations in Infant Mortality Rates Among Counties of the United States: The Roles of Public Policies and Programs." *Demography* 18(4) 695-713, 1981

<sup>20</sup>H Corman and M Grossman, "Determinants of Neonatal Mortality Rates in the U.S." *J Health Economics* 4:213-236, 1985

<sup>21</sup>H Corman, T J Joyce, and M Grossman, "Birth Outcome Production Functions in the U.S." *J Human Resources* 22(3) 339-360, 1987

<sup>22</sup>S Shapiro, L Weiner, and P M Densen, "Comparison of Prematurity and Prenatal Mortality in a General Population and in the Population of a Prepaid Group Practice Medical Care Plan." *Am J Public Health* 48(2) 170-187, 1958

<sup>23</sup>S Shapiro, H Jacobziner, P M Densen, et al., "Further Observations on Prematurity and Perinatal Mortality in a General Population and in the Population of a Prepaid Group Practice Medical Care Plan." *Am J Public Health* 50(9) 1304-1317, 1960

<sup>24</sup>F P Rivara, G A Cully, D Hickok, et al "A Health Program's Effect on Neonatal Mortality in Eastern Kentucky." *Am J Prev Med* 1(3) 35-40, 1985

<sup>25</sup>H C Heins, J M Miller, A Sear, et al "Benefits of a Statewide High-Risk Perinatal Program." *Obstet./Gynecol* 62(3) 294-296, 1983

<sup>26</sup>M C McCormick, S Shapiro and B H Starfield "The Regionalization of Perinatal Service: Summary of the Evaluation of a National Demonstration Program." *J A.M.A* 253(6) 799-804, 1985

<sup>27</sup>Black = nonwhite

<sup>28</sup>Adequacy of care index = 3-category index measuring timing of first visit, number of visits by gestational age and type of hospital service; index originally developed for use in the Kessner, et al (1973) study

<sup>29</sup>No effect on average birthweight but percent LBW lower in experimental group

<sup>30</sup>Higher mean birthweight in augmented care group; higher mean birthweight than in comparison group but no significant difference between groups in percent LBW

<sup>31</sup>When prior (baseline) death rates were controlled there was no significant association between the prenatal care measure and the dependent variable. Significant findings were obtained when baseline death rates were not controlled for whites; the relationship was positive while for blacks, the relationship was negative

<sup>32</sup>Results were significant only when birthweight was controlled

<sup>33</sup>Effect was for preterm delivery which is correlated with birthweight

SOURCE: Off Ice of Technology Assessment 1988

**Table G-4.—Studies of the Cost-Effectiveness of Prenatal Care**

Author	Year(s) and target population	Alternates compared	Perspective of analysis	Maternal costs		Newborn costs			Change in expected birthweight	Ratio of savings to cost
				Prenatal care only	Maternity care	Initial NICU hospital	All initial hospital	Other expenses		
Korenbrot 1984 <sup>1</sup> , State of California, 1984 <sup>2</sup> , Phibbs and Korenbrot, 1986 <sup>3</sup>	1978-82, Medi-Cal eligible pregnant women in California	OB Access Project augmented v routine care for Medi-Cal women			x <sup>16</sup>	x		Rehospitalized during first year	33.8% <sup>15</sup> reduction in LBW rate	1.7 to 26
Malitz 1983 <sup>4</sup>	1981 pregnant women in Texas who would become Medicaid - eligible at delivery	Change in utilization after expansion of Medicaid coverage from pregnancy verification a Eligible for prenatal care only b Eligible for all Medicaid	Medicaid		x		x		NA	a 1.01 <sup>15</sup> (all cases 112 <sup>5</sup> (adolescents) b Net costs = \$558/case and \$332/adolescent
Schramm and Land, 1984 <sup>5</sup>	1981-82, Missouri Medicaid births	Adequate v inadequate care	Medicaid		x		x		16% <sup>15</sup> reduction in LBW rate	1.34 to 1.12 <sup>5</sup> "
Schramm and Land, 1984 <sup>5</sup>	1981-82, pregnant women in Missouri who would become Medicaid eligible at delivery	Unborn Child Program <sup>18</sup> expansion of Medicaid coverage from pregnancy verification	Medicaid		x		x		7-30% <sup>15</sup> reduction in LBW rate <sup>19</sup>	Net costs = \$157/case
Institute of Medicine, 1985 <sup>6</sup>	1980, national cohort of women aged 15-39 with less than 12 yrs of education receiving public assistance	First trimester v other	U S health care system	x				Rehospitalized during first year long-term single-year morbidity costs	13-22% <sup>15</sup> reduction in LBW rate <sup>20</sup>	2.03 <sup>15</sup> to 338 With a 6.4% reduction in LBW rate, savings equal costs



Ricketts, 1986 <sup>7</sup>	1984, low-income women in Colorado	Adequate <sup>21</sup> v. inadequate care	Colorado health care system	x	X	60.3% reduction in LBW rate	2.72 to 4.15
Berger, 1984*	Years not specified, low-income women in Lea County, New Mexico	Some v. no care	Lea County public health care system	x	x	Rehospitalization in first year, medical and institutional costs for neurological impairment to age 21	5.84 <sup>15</sup>
Blackwell, et al., 1983 <sup>9</sup>	1982, Medicaid eligibles and poor ineligible in the U.S.	Augmented v. routine care	Medicaid (Federal Government)	x <sup>16</sup>	x	Rehospitalized in first year	2.93 <sup>15</sup>
Leppert and Namerow, 1985 <sup>10</sup>	1981-82, adolescents seeking care at a hospital in New York City	Augmented: >3 visits v. <3 visits 2. Augmented v. nonprogram	Hospital-based program	x	x	71% <sup>15</sup> reduction in LBW rate	2.14 to 3.05 <sup>15</sup>
Moore, et al., 1986 <sup>11</sup>	1981-84, medically indigent women seeking care at a hospital in San Diego County, California	Augmented (3+ visits) v. nonprogram (<3 visits)	Hospital-based program	x	X	2.28.2% <sup>15</sup> reduction in LBW rate	4.66 <sup>15</sup>
Ershoff, et al., 1983 <sup>12</sup>	1981, pregnant smokers receiving care in a California HMO	Augmented v. routine	One HMO	X	X	27.8% <sup>15</sup> reduction in LBW (NS)	Approximately 2.00
Ershoff, et al., 1982 <sup>13</sup>	1981, all pregnant women receiving care in a California HMO	Augmented v. routine	California	x	X	NS for LBW rate <sup>21</sup> ; fewer preterm and more small-for-date babies for augmented care group	2.5

**Table G.4.—Studies of the Cost-Effectiveness of Prenatal Care—Continued**

Author	Year(s) and target population	Alternates compared	Perspective of analysis	Maternal costs		Newborn costs			Change in expected birthweight	Ratio of savings to cost
				Prenatal care only	Maternity care	Initial NICU hospital	All initial hospital	Other expenses		
Joyce, et al 1986 <sup>14</sup>	1975-80, all pregnant women in the U S	first trimester v other	U S health care system	x					For whites: 27-66 fewer LBW births per 1,000 additional users of first-trimester care For blacks 20-97 fewer LBW births per 1,000 additional users of first-trimester care	Cost of prenatal care only per LBW birth averted = \$3,200 to \$6,500 for whites and \$1,900 to \$9,400 for blacks savings not calculated

Abbreviations: HMO = health maintenance organization; LBW = low birthweight; NA = not available, NS = not significant, OB = obstetrician.

<sup>1</sup>C.C.Korenbrod, "Risk Reduction in Pregnancies of Low-Income Women," *Mobius* 4(3)35-43, 1984

<sup>2</sup>State of California, Health and Welfare Agency, Department of Health Care Services, "Final Evaluation of the Obstetrical Access Pilot Project, July 1979-June 1982," Sacramento, CA, 1984

<sup>3</sup>C S Phibbs, and Korenbrot, C.C., "Cost Impact of Comprehensive Prenatal Care on Medi-Cal With the Implementation of AB3021," testimony to the Ways and Means Committee of the California State Assembly, Apr. 16, 1986

<sup>4</sup>D Malitz, "A Cost-Benefit Analysis of Extending Medicaid Coverage To Provide Prenatal Care to Pregnant Women," Study submitted to the Texas Department of Human Resources, Austin, TX, May 1983  
<sup>5</sup>W Schramm, and G Land, "Prenatal Care and Its Relationship to Medicaid Costs," prepared under HCFA Grant No 11-P-98305, State Center for Health Statistics, Division of Health, Missouri Department of Social Services, December 1984.

<sup>6</sup>Institute of Medicine, *Preventing Low Birthweight* (Washington, DC National Academy Press, 1985)

<sup>7</sup>S Ricketts, Family Health Services Division, Colorado Department of Health, Denver, CO, Internal memorandum, February 1986

<sup>8</sup>L. B. Berger, "Public/Private Cooperation in Rural Maternal Child Health Efforts The Lea County Perinatal Program," *Texas Medicine* 80:54-57, September 1984.

<sup>9</sup>A.G. Blackwell, L. Salisbury, and A.P. Arriola, Public Advocates, Inc., San Francisco, CA, "Administrative Petition To Reduce the Incidence of Low Birth Weight and Resultant Infant Mortality," administrative petition to the U.S. Department of Health and Human Services, 1983

<sup>10</sup>P C Leppert, and P B Namerow, "Costs Averted by Providing Comprehensive Prenatal Care to Teenagers," *J. Nurse-Midwifery* 30(5):285-289, 1985.

<sup>11</sup>T R Moore, W Origel, T C. Key, et al., "The Perinatal and Economic Impact of Prenatal Care in a Low-Socioeconomic Population," *Am J Obstet. Gynecol* 154(1)29-33, 1986

<sup>12</sup>D.H. Ershoff, N.K. Aaronson, B.G. Danaher, et al., *Cost-Benefit Analysis of a Comprehensive Prenatal Health Education Program Within an HMO Setting, Executive Summary*, prepared for the Office of Health Information, Health Promotion and Physical Fitness and Sports Medicine, Public Health Service, U.S. Department of Health and Human Services, Washington, DC, July 1982

<sup>13</sup>D.H. Ershoff, N.K. Aaronson, B.G. Danaher, et al., "Behavioral, Health, and Cost Outcomes of an HMO-Based Prenatal Health Education Program," *Public Health Reports* 98(6):536-547, 1983.

<sup>14</sup>T Joyce, H Corman, and M Grossman, "A Cost-Effectiveness Analysis of Strategies To Reduce Infant Mortality." *Medical Care*. in press

<sup>15</sup>Calculation by OTA

<sup>16</sup>Physician fees only

<sup>17</sup>Adequate care = care begun by the 4th month with at least five visits for preterm deliveries and at least eight visits for full-term births Inadequate care = all other combinations of timing and frequency

<sup>18</sup>Prenatal care was provided to previously ineligible first-time mothers under this program

<sup>19</sup>Range is based on analyses on 2 separate years of data

<sup>20</sup>The major objective of this study was to estimate savings if the Public Health Service goal for the LBW rate (9% ) was met

<sup>21</sup>Adequate = 6 + visits, Inadequate = 5 or fewer visits

<sup>22</sup>Range is for current Medicaid eligibles and ineligibles

<sup>23</sup>Overall figures for LBW not reported.

SOURCE Office of Technology Assessment, 1988

## Approach Used To Estimate the Net Long-Term Health Costs of Low Birthweight<sup>2</sup>

Low birthweight is associated with, and in some cases clearly brings about, increased levels of illness and disability over a person's lifetime (580,665). It follows, then, that if the low birthweight rate—i.e., the percentage of live births that are low birthweight—could be reduced, there would be fewer infants born with chronic illness and physical or developmental disability, with consequent savings in the health care costs of treating these conditions.

Long-term health care costs associated with low birthweight births result from early intervention programs, special education, adult care and services, and institutional or foster care. Other long-term health care costs, not considered in OTA's analysis, may result from unpaid parental and other voluntary care, and occasional acute care expenses beyond the first year.

OTA's analysis made the following assumptions regarding the types of care that low birthweight children will receive over their lifetimes and the costs of that care:

- all infants surviving at age 1 will survive to age 35, regardless of their level of disability;
- costs of care are calculated only to age 35;
- the severity of disability as evaluated at age 1 is constant through age 35; and
- the costs of special services provided to moderately and severely impaired populations (i. e., institutional or foster care, adult care and services, special education, and early intervention), by level of disability, are the same as the costs of providing these services to severely and moderately mentally retarded people.

Available data on the quantity and costs of care are imperfect and in some cases incomplete. To account for the uncertainty in the estimates, OTA estimated the long-term costs of low birthweight in a range, with high- and low-cost boundaries.

**Estimates of Long-Term Outcomes by Birthweight Group.—To compare the net extra long-term costs of care for low birthweight babies with those of normal birthweight babies, OTA needed data on health out-**

<sup>2</sup>Birthweight categories are defined here as follows. normal birthweights at least 2,500 grams, and low birthweight is under 2,500 grams. Low birthweight has two parts: very low birthweight (under 1,500 grams) and moderately low birthweight (from 1,500 to 2,500 grams).

<sup>3</sup>Early intervention programs are broadly defined by the Education of the Handicapped Act Amendments of 1986 (Public Law 99-457) as developmental services provided to handicapped infants or toddlers. These services include family training, counseling, and home visits; special instruction; speech pathology and audiology; occupational therapy, physical therapy; psychological services; case management services, medical services only for diagnostic or evaluation purposes; early identification, screening and assessment services; and health services necessary to enable the infant or toddler to benefit from the other early intervention services

comes across all birthweight categories, including normal birthweight. One study, by Shapiro, et al. (580), collected data on the outcomes of approximately 200,000 births in regions of six States in 1978-79. That study included all birthweight categories and also provided information on developmental outcomes at age 1 for the followup population (the roughly 80 percent of the infants in the study population that survived to year 1).

Another study that evaluated a followup population of neonatal survivors to determine developmental outcomes, by Marlow, et al. (403), was based on a sample of 1,000 births in Great Britain from 1976-80. The Marlow, et al., study included only births of less than 2,000 grams, so the results are not considered in OTA's analysis. As shown in table G-5, however, neonatal mortality and morbidity for very low birthweight infants in the Shapiro and Marlow studies are quite similar.

Health outcomes at age 1 by birthweight category as reported by Shapiro, et al., are shown in table G-6 (580). Note that 1-year-olds evaluated as having mild congenital anomalies are grouped in the normal outcomes category in the table. To the extent that children with mild congenital anomalies have differentially greater care needs than normal birthweight children, OTA's analysis underestimates the long-term health care costs of low birthweight.

**Table G-5.— Health Outcomes Per 1,000 Very Low Birthweight Births**

Outcome	Shapiro, et al. <sup>a</sup>	Marlow, et al. <sup>b</sup>
Normal outcome ... , . . . . .	390	331
Moderate impairment . . . . .	102	125
Severe impairment . . . . .	69	74
Dead (neonatal mortality rate) <sup>c</sup> . . . . .	439	470

<sup>a</sup>Shapiro, M C, McCormick, B H Starfield, et al., "Changes in Infant Morbidity Associated With Decreases in Neonatal Mortality," *Pediatrics* 72(3) 408-415, 1983  
Shapiro, et al., defined adverse outcomes among survivors in the following terms 1) severe impairment (i.e., a congenital anomaly likely either to shorten life or affect function severely and/or a gross motor delay corresponding to a developmental quotient (DQ) < 70), 2) moderate impairment (i.e., a congenital anomaly likely to affect functioning moderately and/or a suspect gross motor performance corresponding to a DO of 70 to 79; and 3) mild congenital anomaly (i.e., a congenital anomaly likely to have a minor effect on functioning). The sharpest distinction is between the first category of severe conditions, which invariably require extensive medical resources and often require social support, and the latter two categories. In this table, OTA classified mild congenital anomalies as normal outcomes.

<sup>b</sup>Marlow, S.W.D'Souza, and M L Chiswick, "Neurodevelopmental Outcome in Babies Weighing Less Than 2,001 g at Birth," *Br Med J* 2941582.1588, 1987  
Marlow, et al., defined adverse neurodevelopmental outcomes among survivors in three major groups 1) major handicap (cerebral palsy, developmental retardation (Griffiths quotient or IQ < 71), blindness or deafness sufficient to warrant special education, and hydrocephalus); 2) minor developmental impairment (squints, minor degrees of refractive error or hearing loss, abnormalities of muscle tone without disability, poor fine motor function, non febrile fits, or borderline results of psychometric testing (Griffiths quotient or IQ from 71 to 85).

<sup>c</sup>The neonatal mortality rate is defined as the number of infants who die in the first 28 days of life per 1,000 live births

SOURCE Office of Technology Assessment, 1988

**Table G-6.— Health Outcomes Per 1,000 Live Births by Birthweight Category**

Outcome at the end of 1 year <sup>a</sup>	Low birthweight		Total ( < 2,500g)	Normal birthweight ( > 2,500g)	All birthweights
	<1,500g	1,500-2,500g			
Normal outcome . . . . .	364	818	744	909	899
Moderate impairment . . . . .	96	106	104	68	69
Severe impairment . . . . .	65	40	44	18	20
Dead (infant mortality rate) <sup>b</sup> . . . . .	475	36	108	5	12

<sup>a</sup>Shapiro, et al., defined adverse outcomes among survivors in the following terms: 1) severe impairment (i.e., a Congenital anomaly likely either to shorten life or affect function severely and/or a gross motor delay corresponding to a developmental quotient (DQ) < 70); 2) moderate impairment (i.e., a congenital anomaly likely to affect functioning moderately and/or a suspect gross motor performance corresponding to a DQ of 70 to 79, and 3) mild congenital anomaly (i.e., a congenital anomaly likely to have a minor effect on functioning). The sharpest distinction is between the first category of severe conditions, which invariably require extensive medical resources and often require social support, and the latter two categories. In this table, OTA classified mild congenital anomalies as normal outcomes.

<sup>b</sup>The infant mortality rate is defined as the number of infants who die in the first year of life Per 1,000 live births.

SOURCE: Reproduced by permission of *Pediatrics*. S. Shapiro, M C McCormick, B H Starfield, et al "Changes in Infant Morbidity Associated With Decreases in Neonatal Mortality," *Pediatrics* 72(3):408-415, 1983

Note also that the Shapiro, et al., data in table G-6 are based on developmental outcomes in 1978-79 and therefore do not capture the impact of new technologies introduced since then, such as those in neonatal intensive care units (665). To the extent that the disability rate at age 1 has improved since 1980, OTA's analysis overestimates the long-term health care costs of low birthweight.

**Assumptions About the Kinds of Services Received.**—Because information on the kinds of services that will be provided to children who have severe or moderate developmental impairments at age 1 does not exist, OTA's analysis is based on the care provided to severely and moderately mentally retarded people in the United States. Barden, et al. (46), analyzed the life-long services required for mentally retarded people in the following categories: institutionalization, foster care, adult care and services, and special education. OTA included these services and one more, early intervention programs, in its cost-effectiveness analysis.

Barden, et al. (46), assumed that all severely mentally retarded people would require institutionalization. In addition, they assumed that one-half of all moderately or mildly mentally retarded people would receive foster care from age 5 to 20, and that all of them would receive adult care and services from age 20 for life. In the general population, less than half of the severely mentally retarded people in the United States are actually in public and private mental retardation facilities (361). The placement of the others, whether at home or in foster or residential care, is unclear.

In its analysis, OTA used two sets of assumptions regarding the special services provided to severely and moderately impaired children (see table G-7). The high-cost estimate of the costs of long-term care is based on the assumption that all severely impaired children will receive institutional care from age 5 to 35. The low-cost estimate, on the other hand, is based

on the assumption that only 25 percent of severely impaired children will receive institutional care from age 5 to 35. Another 25 percent will receive foster care from age 5 to 20, and the remaining 50 percent will

**Table G-7.—Assumptions Regarding the Special Services Required by the Severely and Moderately Impaired Populations in OTA's Analysis (in 1986 dollars, undiscounted)**

	Percent of population receiving service	
	High-cost estimate	Low-cost estimate
<b>Severely impaired</b>		
Institutional care (ages 5-35) . . . . .	100 %	25%
Foster care (ages 5-20) . . . . .	0%	25%
Adult care and services (ages 21-35) . . . . .	0%	75%
Special education (ages 4-10) . . . . .	100 %	100%
(ages 11-15) . . . . .	100 %	100%
(ages 16-20) . . . . .	100 %	100%
Early intervention (ages 0-3) . . . . .	100 %	100%
<b>Moderately impaired</b>		
<b>Institutional care (ages 5-35) . . . . .</b>	<b>0%</b>	<b>0%</b>
Foster care (ages 5-20) . . . . .	50%	25%
Adult care and services (ages 21-35) . . . . .	100%	100%
Special education (ages 4-10) . . . . .	100%	100%
(ages 11-15) . . . . .	100%	100%
(ages 16-20) . . . . .	100%	100%
Early intervention (ages 0-3) . . . . .	100%	100%

SOURCE: Office of Technology Assessment, 1988

be cared for at home from age 5 to 20. A further assumption in the low-cost estimate is that beginning at age 21, all noninstitutionalized severely impaired individuals will receive adult care and services until at least age 35.

In both the high- and low-cost estimates, it is assumed that none of the moderately impaired population will enter institutions. The high-cost estimate is based on the assumption that 50 percent of moderately impaired children will receive foster care and 50 percent will receive care at home from age 5 to 20. The low-cost estimate is based on the assumption that only 25 percent of moderately impaired children will receive foster care from age 5 to 20; 75 percent will receive care at home from age 5 to 20. In both the high- and low-cost estimates, it is assumed that all moderately disabled individuals will receive adult care and services from age 21 to 35.

The other special services for the impaired population included in OTA's analysis were special education and early intervention programs. In Barden, et al. (46), the level of special education required (and associated costs) depended on a child's age and level of mental retardation, although both severely and moderately retarded children received special education from ages 4 through 20. OTA adopted Barden, et al.'s assumption about special education for severely and moderately impaired children.

Early intervention is a new and evolving concept in the care of disabled children, so the estimated levels of care (and associated costs) vary. In one study, early intervention was provided for both severely and moderately developmentally disabled children from birth through age 3 (736). OTA assumed that all moderately and severely disabled children would receive early intervention through age 3.

**Assumptions About the Cost of Care.—In the study by Barden, et al. (46), the costs of institutionalization were calculated on the basis of data obtained at the Wisconsin Center for Developmental Disabilities. Barden, et al.'s estimate of \$36,500 per year in 1982 is similar to national information obtained by OTA for 1985 (\$35,000 to \$45,000) (361). Barden, et al., subtracted \$4,000 per year from their figure of \$36,500 to net out normal personal consumption costs, yielding an estimate of \$32,500 per year (in 1982 dollars).**

OTA's analysis incorporates Barden, et al.'s assumptions about the cost of institutional care. Since costs reported in Barden, et al.'s analysis were in 1982 dollars, however, OTA adjusted them to 1986 dollars using the medical care component of the Consumer Price Index (an increase of 13.6 percent). This adjustment yielded an estimated cost of institutionalization in 1986 dollars: \$36,920 per year (see table G-8).

**Table G-8.—Assumptions Regarding the Annual Cost of Special Services Required by the Severely and Moderately Impaired Populations in OTA's Analysis (in 1986 dollars, undiscounted)**

	Annual cost per child receiving the service
Annual cost of institutional care (ages 5-35) . . . . .	\$36,920 <sup>a</sup>
Annual cost of foster care (ages 5-20) . . . . .	\$ 5,680 <sup>a</sup>
Annual cost of adult care and services (ages 21-35) . . . . .	\$13,632
Annual cost of special education (ages 4-10) . . . . .	\$ 5,888
(ages 11-15) . . . . .	\$ 6,549
(ages 16-20) . . . . .	\$ 6,501
Annual cost of early intervention (ages 0-3) . . . . .	\$2,045 to \$4,089

<sup>a</sup>This estimate does not include \$4,544 in personal consumption costs

<sup>b</sup>Special education costs represent those costs in excess of cost of normal education

SOURCE Office of Technology Assessment, 1988

OTA's assumptions about the costs of foster care and adult care and services are similarly based on those of Barden, et al. (46) and updated to 1986 dollars. The annual cost of foster care in 1986 dollars is estimated to be \$5,680, and the annual cost of adult residential care and services is estimated to be \$13,632.

Special education costs, as mentioned above, depend on age and the level of mental retardation. The cost assumptions of Barden, et al. (46), are based on a nationwide study by Kakalik, et al. (313). Assuming that all mentally retarded people receive special education, and in the absence of further national information on the added costs of special education, OTA figures used the same figures for both its high- and low-cost estimates.

For the costs of early intervention from birth to age 3, OTA used as a low-cost estimate Walker and colleagues' (736) estimate of \$2,045 per year (in 1986 dollars). Since Walker and colleagues' estimate was based on one program in one area and since the concept of early intervention itself is evolving, OTA's high-cost estimate was double this figure: \$4,089 per year.

The costs shown in table G-8, which summarizes OTA's assumptions regarding the long-term costs of services provided to moderately and severely impaired children, are in 1986 undiscounted dollars. Because long-term costs of services are spread out over 34 years, however, costs incurred in the distant future must be discounted to their present (1986) value.

The choice of a discount rate is somewhat arbitrary. Although the rate should represent society's valuation of the costs of the opportunity of present v. future consumption, it is difficult to know what rate actually rep-

resents that value. Barden, et al. (46), used a 7-percent discount rate. Others have used higher rates, up to 10 percent. Ten percent appears to be quite high as a discount rate in real after-tax dollars. Indeed, 7 percent may itself be high. (A high discount rate implies a lower cost estimate than a low discount rate.) OTA applied a 7-percent discount rate to both its low-cost estimate and its high-cost estimate of the cost of special services required by moderately and severely impaired populations. OTA also applied a 4-percent discount rate to these two estimates.

**Results.** —Table G-9 presents the estimated lifetime cost of special services for each moderately and severely impaired child, discounted at 4 percent and 7 percent. For the moderately impaired, the discounted lifetime cost of services ranges from \$90,000 to \$167,000 in 1986 dollars. For the severely impaired, the cost ranges from \$177,000 to \$634,000. Although the range in each case is wide, the lifetime costs are high even under the most conservative assumptions.

The percentage of births that result in severe and moderate impairment varies by birthweight category. The expected lifetime cost of special services per birth in each birthweight category is shown in table G-10.

**Table G-9.—Low-Cost and High-Cost Estimates: Lifetime Cost of Special Services<sup>a</sup> for Each Moderately and Severely Impaired Child (in 1986 dollars, discounted at 4 and 7 percent)**

	Cost per child	
	Moderately impaired	Severely impaired
<b>Low-cost estimate</b>		
4%/o discount rate . . . . .	\$147,000	\$292,000
70/o discount rate . . . . .	\$90,000	\$177,000
<b>High-cost estimate</b>		
4%/o discount rate . . . . .	\$167,000	\$634,000
7%/o discount rate . . . . .	\$106,000	\$413,000

<sup>a</sup>Cost of special services for impaired individuals from 1 to 35 years of age. SOURCE: Office of Technology Assessment, 1988

The estimates in table G-10 can be used to calculate the net long-term savings that can be expected from reducing the rate of low birthweight. Two assumptions underlie the calculation:

- moving a birth from the low birthweight category to the normal birthweight category will reduce the probability of impairment to the level experienced by infants in the normal birthweight category; and
- reductions in the number of low birthweight babies in each low birthweight category (moderately low birthweight and very low birthweight) will occur in proportion to the relative frequency of these categories in the population of births. (In 1985, 82 percent of all low birthweight infants were moderately low birthweight; 18 percent were very low birthweight.)

According to OTA's calculation based on these assumptions, the net long-term savings that would be gained by preventing each low birthweight birth (i.e., moving it to the normal birthweight category) would be between approximately \$9,000 and \$23,000 (see table G-II). Or, restated, the net long-term cost of each low birthweight birth is between \$9,000 and \$23,000.

**The Impact of Health Insurance Coverage on the Use of Prenatal Care**

OTA's cost-effectiveness analysis in chapter 4 used data from the 1982 National Survey of Family Growth to estimate the proportion of pregnant women newly eligible for Medicaid who would switch from late initiation of prenatal care to care in the first trimester of pregnancy as a result of the expansion of Medicaid eligibility to all pregnant women in poverty. OTA assumed that 44 percent of women who are newly eligible for Medicaid, and who would not otherwise receive first-trimester care, would switch to first-tri-

**Table G-10.—Low-Cost and High-Cost Estimates: Expected Lifetime Cost of Special Services<sup>a</sup> Per Birth in Specified Birthweight Categories (in 1986 dollars, discounted at 4 and 7 percent)**

	Cost per birth by birthweight category		
	Normal birthweight	Moderately low birthweight	Very low birth weight
<b>Low-cost estimate</b>			
40/o discount rate . . . . .	\$15,000	\$27,000	\$33,000
70/o discount rate . . . . .	\$9,000	\$17,000	\$20,000
<b>High-cost estimate</b>			
40/o discount rate . . . . .	\$23,000	\$43,000	\$57,000
70/o discount rate . . . . .	\$15,000	\$28,000	\$37,000

<sup>a</sup>Cost of special services for impaired individuals from 1 to 35 years of age. SOURCE: Office of Technology Assessment, 1988.

**Table G-1 1.—Low-Cost and High-Cost Estimates:  
Net Long-Term Cost<sup>a</sup> of Low Birthweight Per Birth  
(in 1986 dollars, discounted at 4 and 7 percent)**

Low-cost estimate	
4% discount rate . . . . .	\$13,080
7% discount rate . . . . .	\$ 8,540
High-cost estimate	
4% discount rate . . . . .	\$22,520
7% discount rate . . . . .	\$14,620

<sup>a</sup>Cost from age 1 to 35

SOURCE Office of Technology Assessment, 1988

mester care as a result of expanded eligibility for Medicaid. This assumption is based on the fact that approximately 44 percent of pregnant women who were eligible for Medicaid in 1982 received first-trimester prenatal care.

Other data are available on the use of prenatal care by insurance status, but in most available studies, the comparison group was not limited to women in poverty. Spitz, et al., using 1976-78 data from Georgia, found that the proportion of Medicaid recipients receiving first-trimester prenatal care differed little from the proportion in three non-Medicaid comparison groups consisting of participants in two other publicly subsidized programs and women with less than a high school education (609a). The women with the highest rate of first-trimester care were the women of low educational attainment who were not served by any

publicly subsidized program. The women most probably had higher incomes than those served by the public programs,

Norris and Williams, in a 1978 study in California, found that non-Medicaid women (including nonpoor women) obtained earlier prenatal care than Medicaid women in that year (462a). Cooney studied prenatal care among women in New York City with less than 12 years of education in 1981 (117a) and compared the percentage of Medicaid recipients receiving late or no prenatal care with that of privately insured women in 30 subgroups defined by race, marital status, and age. In 23 of the 30 subgroups, the percentage of Medicaid recipients receiving delayed or no care was higher than the percentage of women with private insurance.

Hadley examined differences between Medicaid and non-Medicaid women in poverty in the number of maternity care visits as reported on the National Health Interview Survey between 1978 and 1982 (243a). Hadley analyzed a sample of women with infants 3 months of age or younger at the time of the interview. Annual doctor visits reported by these women largely reflected prenatal visits but also included postpartum care and visits not directly related to the pregnancy. Medicaid recipients had on average one and one-half more visits than did the uninsured women (see table G-12). The insured poor women had more visits on average than either Medicaid recipients or the uninsured women. This fact probably reflects the higher family income and stability among the in-

**Table G-12.—Annual Doctor Visits and Other Characteristics of a Sample of Poor Women With an Infant  
3 Months of Age or Younger, by Health Insurance Status<sup>a</sup>**

Characteristics	Women without health insurance	Women with Medicaid	Women with insurance other than Medicaid
Number of women in sample . . . . .	71	98	132
Education (yrs.) . . . . .	10.9	10.6	11.7
Real income per family member (1982 dollars) . . . . .	\$1,672	\$1,438	\$2,429
Black . . . . .	19.7%	42.9%	18.20/o
Community type			
Central city . . . . .	28.2%	48.0%	28.0%
Rural . . . . .	56.3%	19.4 %	40.20/o
Region			
Northeast . . . . .	9.9%	23.5%	17.5%
South . . . . .	53.5%	24.5%	43.90/o
North central . . . . .	15.5%	31.6%	25.00/o
West . . . . .	21.1%	20.45	13.60/o
Marital status and age			
Unmarried, 17-19 . . . . .	9.9%	21 . %	3.80/o
Unmarried, 20+ . . . . .	8.5%	45.9%	6.1%
Married, 17-19 . . . . .	12.7%	5.1%	12.1%
Fair or poor health . . . . .	14.1%	17.3%	12.1%
Number of annual doctor visits per woman <sup>b</sup> . . . . .	11.0	12.6	13.1

<sup>a</sup>The data in this table are based on a sample of poor women (i.e., women living in families in which the real income per family member is less than \$3,500 in 1982 dollars) who responded to the 1978, 1980, or 1982 National Health Interview Survey. Insurance status reflects coverage at some time during the interview year. It was not possible to identify when during the pregnancy coverage of a given type began.

<sup>b</sup>Reported annual doctor visits primarily reflect prenatal care visits, but also include visits for postpartum care and for care unrelated to a woman's pregnancy.

SOURCE J Hadley, calculations based on the 1978, 1980, and 1982 National Health Interview Survey, 1987

sured poor (e. g., income per family member was 68 percent higher among the insured poor than among Medicaid recipients). Hadley's data show clearly, how-

ever, that eligibility for third-party payment, whether it be Medicaid or other insurance, has a real effect on the quantity of prenatal care that poor women receive.



# Disorders Currently Detectable by Newborn Screening

---

## Introduction

As noted in chapter 5, the identification of phenylketonuria (PKU) and discovery of the treatment to prevent its associated mental retardation provided the first major impetus for routine newborn screening. The clinical course and characteristics of PKU and the following eight congenital disorders detectable through newborn screening are described below:

1. congenital hypothyroidism,
2. galactosemia,
3. maple syrup urine disease (MSUD),
4. homocystinuria,
5. biotinidase deficiency,
6. sickle cell anemia,
7. cystic fibrosis, and
8. congenital adrenal hyperplasia (CAH).

These disorders (with the exception of most cases of congenital hypothyroidism) are genetic in origin and are transmitted in a recessive genetic pattern. They are amenable to newborn screening techniques because of quantitative or qualitative differences detectable in certain biochemical markers. As outlined below, some of the disorders are treatable by supplying the missing enzyme or end product or by removing substances from the child's environment.

## Phenylketonuria

The group of disorders that are included under the heading of PKU share a common feature: impaired metabolism of phenylalanine, an amino acid contained in protein. This genetic abnormality prevents the normal conversion of phenylalanine into tyrosine, a reaction occurring in the liver (454). Defects in the production of certain enzymes result in the progressive accumulation of phenylalanine in the blood and tissues. The abnormally high levels of this amino acid in the blood and tissues interfere with brain development and cause damage to the central nervous system, although the mechanism by which this damage occurs is not known (597).

Newborn infants with PKU appear normal at birth and, because of the disease, frequently go on to develop excessively blond hair, blue eyes, and fair skin. Various manifestations of the disorder begin to appear in the first few months of life, including irritability,

diaper rash, seizures, and delayed development. Gradually, it becomes apparent that the infant is obviously mentally retarded. It is estimated that **96 to 98** percent of all untreated infants with classical PKU will become mentally retarded, most of them severely or profoundly retarded (644).<sup>1</sup> With supportive care alone, the disease is not directly lethal, but the overall lifespan of mentally retarded individuals with PKU is reduced. The incidence of classical PKU is usually between 1 in 10,000 and 1 in 15,000 live births (378), although in some populations it is even rarer (e. g., PKU is particularly rare in blacks).

Treatment consists of restriction of dietary phenylalanine to the minimum amount required for growth and development. A special formula for newborns and a food substitute for older children that restricts intake of phenylalanine from the diet is necessary to provide a nutritionally adequate diet when natural protein sources are restricted. If the special diet is begun before 2 to 4 weeks of age and maintained properly throughout development (and possibly indefinitely), infants with PKU can attain normal development, behavior, and intelligence. Such treatment generally does not reverse mental retardation if started well after symptoms have appeared. However, recent evidence suggests that some perceptual motor problems and learning disabilities may exist even in treated children with PKU, and it is not yet known whether these can be completely avoided (485). The average lifespan of treated individuals is unknown, but it is expected to be unaffected by PKU. Periodic monitoring of blood phenylalanine levels is needed to ensure that the level is within safe limits during development, and a nutritionist usually assists in monitoring and coordinating nutritional regimens. Current recommendations are that the special diet be continued indefinitely. The need for dietary restriction in individuals with PKU beyond adolescence has not been investigated.

For many years, it has been known that excess phenylalanine in a mother acts as a teratogen to the fetus: high maternal blood phenylalanine levels (above

<sup>1</sup>PKU a condition characterized by the progressive accumulation of phenylalanine in the blood and tissues (hyperphenylalaninemia), exists not only in its classical form, which is associated with severe mental retardation, but also in a spectrum of milder forms, in which developmental delay is more variable. Some of the milder forms do not result in mental retardation and do not require treatment.

20 mg/dl) during pregnancy are associated with a high rate of mental retardation, microcephaly, congenital heart defects, and low birthweight among offspring of women with untreated maternal PKU (346,392). Maintaining normal phenylalanine levels by dietary restriction in mothers with PKU can be successful in preventing at least some of these adverse effects in offspring (371), but treatment of women with PKU after a pregnancy has begun appears to be ineffective or only partially effective.

The overall efficacy of a phenylalanine-restricted diet during pregnancy in preventing the complications of maternal PKU is currently being examined by a U.S. and Canadian prospective collaborative study funded by the National Institute of Child Health and Human Development (346). As many as possible of the estimated 2,400 women in the United States at risk for maternal PKU are being followed and advised to go on the special diet before and during pregnancy. After the study is complete, the responsibility for tracking women with PKU during their childbearing years will fall on the individual screening programs. This tracking will require reliable monitoring systems and thorough educational efforts to maintain contact with women at risk.

## Congenital Hypothyroidism

Infants with congenital hypothyroidism have a deficiency of thyroxine (T<sub>4</sub>), a hormone essential for physical growth and early brain development. Without thyroxine, permanent, irreparable brain damage occurs. The thyroid gland may be missing, incompletely developed, dislocated, or dysfunctional in congenital hypothyroidism (551), and each form of the disease may be associated with a different cause. Accordingly, symptoms vary widely among children with congenital hypothyroidism, and the prognosis may vary from case to case (360). In all of them, however, the infants' thyroid glands are unable to produce sufficient thyroxine, whether or not there are high serum levels of thyroid-stimulating hormone,

Congenital hypothyroidism is several times more frequent than PKU, with an incidence rate estimated at 1 in 3,000 to 1 in 4,000 live births. It is one of the more common causes of mental retardation, and is more common in girls than in boys. It is not considered to be genetic in origin in more than about 25 percent of cases. Most infants with congenital hypothyroidism lack conspicuous features of the disease in the first few days after birth. Later on, constipation, lethargy, prolonged jaundice, poor feeding, and hypothermia are among the nonspecific neonatal symptoms that commonly develop (360). The progressive course

of the disease eventually results in mottled dry skin, coarse facial features, growth retardation, and impaired motor function. Most critically, the disease interferes with brain function and normal growth and development, and leads to some degree of mental retardation. Before screening for congenital hypothyroidism was available, most infants with the disease were diagnosed on the basis of some of these symptoms sometime after 3 months of age or even much later. By that time, however, irreversible damage to the brain had usually occurred.

Treatment for congenital hypothyroidism depends on daily oral ingestion of tablets containing L-thyroxine to raise serum thyroxine levels into the normal range. The tablets should be taken indefinitely, and serum thyroxine levels should be monitored periodically to prevent overtreatment or undertreatment. Treated children appear to be normal in intellectual, psychosocial, and physical development. Recent observations have suggested, however, that there may be some residual behavioral problems; subtle, minor differences have been noted between some treated children and their normal siblings (550). The severity of the children's condition at birth and the time it took to bring their serum thyroxine levels into the normal range may account for these findings, but systematic, long-term followup is needed to determine final outcome. There is general agreement that screening and early treatment are essential to improved outcome in patients with this disorder.

## Galactosemia

The initial symptoms of galactosemia occur in the first week of an infant's life, with vomiting after the start of milk ingestion. Increasing lethargy and liver dysfunction may occur soon thereafter, and unless treated immediately, galactosemia can be rapidly fatal. Septicemia (blood poisoning) and progressive liver damage are the most common causes of death in infants with untreated galactosemia. Mental retardation, cataracts, and cirrhosis of the liver are the most frequent consequences of suboptimal treatment in the survivors who are eventually diagnosed on the basis of clinical presentations. The average age at diagnosis of these infants is 3 to 6 weeks.

The symptoms of galactosemia result from an accumulation of galactose (a component of the sugar (lactose) found in milk) and a metabolite known as galactose-1-phosphate in the blood, leading to excretion of high levels of galactose in the urine. Galactose, absorbed in the small intestine from milk and milk products, is normally converted to glucose in the liver. Infants with galactosemia are deficient in one of the

enzymes that is required to catalyze this reaction, so galactose and products of its metabolism accumulate unmetabolized. The disorder is found in approximately 1 in **60,000** live births. Screening for galactosemia using cord blood would be even better than using newborn blood in facilitating the earlier diagnosis and initiation of treatment.

To avert neonatal death or mental retardation, screening for galactosemia must be done in the first few days of life. Treatment for galactosemia depends on completely eliminating milk and its products from the diet throughout an individual's life. Overall, the elimination of milk products prevents early death and promotes normal mental and physical development in most children with galactosemia, and long-term studies show normal adult functioning in most early treated cases (138).

The results of apparently optimal treatment for galactosemia have not been completely satisfactory in all cases, as a small percentage of treated children have had major neurological deficits (546). Many girls with galactosemia seem to have developed ovarian failure despite treatment. Finally, a specific speech abnormality (verbal dyspraxia) is being reported in an increasing number of individuals with galactosemia, despite their having received the same treatment that prevented such symptoms in other individuals (**82,735**).

## Maple Syrup Urine Disease

MSUD (also called branched-chain ketoaciduria) is a disorder of amino acid metabolism involving the three branched-chain amino acids: leucine, isoleucine, and valine. Affected individuals have a deficiency of one of the enzymes that control the pathway of the catabolism of these amino acids. Several forms of MSUD have been reported: a classic, severe form and milder variant forms. The urine of affected individuals has a distinctive odor that has been described as smelling like maple syrup. The incidence of classic MSUD **ranges from 1 in 120,000 to 1 in 290,000**, with a figure of 1 in 225,000 being most frequently cited (455).

Infants with MSUD appear normal at birth, but by the end of the first week, develop worsening signs of central nervous system damage with poor feeding and vomiting. Convulsions and lethargy leading to coma may occur shortly thereafter. The infants become progressively more lethargic and may suddenly go into a coma and die from profound ketoacidosis and brain damage, not uncommonly in the first 2 weeks of life (**633**). **Electroencephalographic abnormalities** support the evidence of severe brain dysfunction in infants with MSUD. Few manage to survive untreated, although

they usually sustain severe mental and motor retardation (**453**).

Newborn screening for this disorder is useful only if it leads to rapid diagnosis and immediate treatment in the first week or two of life. Treatment must be life-long and consists of dietary restriction of the branched-chain amino acids. As in treatment for PKU, a special formula is necessary to ensure adequate nutrition. Initiation of the special diet before the onset of acute symptoms can result in survival with normal intelligence, although the long-term prognosis of treated children with MSUD is still unknown.

## Homocystinuria

Classical homocystinuria is caused by a deficiency of one of the enzymes involved in the metabolism of an amino acid known as homocystine. As a result of this enzyme deficiency, homocystine and another amino acid, methionine, accumulate in the body and are excreted in large amounts in the urine.<sup>2</sup>

The incidence of classical homocystinuria has been estimated at 1 in 200,000 live births (437), but this figure may be an underestimate since it is based on the number of cases detected through newborn screening performed in the first week of life, and screening at this time may miss as many as **50** percent of affected cases. The optimal time for collecting blood for newborn screening for this disorder is 4 to 6 weeks of age (453).

An infant born with homocystinuria develops clinical signs of the disease relatively slowly. Developmental retardation is the first general sign of the disease. A number of manifestations may appear during childhood or later in life—e.g., downward dislocation of the ocular lenses; thinning and lengthening of the long bones; sparse, fair hair; and seizures. Homocystinuria can lead to life-threatening episodes of vascular thrombosis (clotting of blood). It has been estimated that most of the surviving, untreated infants with this disease go on to have mental deficiency, and half of them may die by age **25**.

The major mental and motor manifestations of homocystinuria may be controlled if affected infants who are not biochemically responsive to vitamin B<sub>6</sub> are treated with a diet that restricts dietary intake of methionine and those who are vitamin B<sub>6</sub> responsive are treated with vitamin B<sub>6</sub>. Long-term prognosis of those who are treated, particularly the risk of thrombosis, is not known.

<sup>2</sup>Classical homocystinuria, in which there is an increased methionine level, can be detected by current tests used in newborn screening. There are other forms, however, that do not have an increased methionine level and cannot be detected by these tests.

## Biotinidase Deficiency

The cause of biotinidase deficiency is an inability to recycle the B vitamin biotin. The incidence of this disorder has been estimated at 1 in 45,000 live births (759). Infants with biotinidase deficiency appear normal at birth, but may develop symptoms of the disorder in the first weeks or months of life. The most common presenting symptoms include seizures, ataxia, hypotonia, developmental delay, hearing loss, skin rash, and/or loss of hair. If untreated, biotinidase deficiency can lead to acidosis, resulting in coma or death in infancy (760).

Biotinidase deficiency is one of the most recent additions to newborn screening programs, so current experience with its diagnosis and treatment is still limited. Since symptoms can appear as early as 3 weeks of age and can be rapidly fatal, screening in the first week of life is probably the optimal time for detecting this disease. Experience to date suggests that affected infants can improve markedly with oral doses of biotin and that this treatment can prevent most or all of the symptoms of the disease. If treatment for biotinidase deficiency is begun too late, however, irreversible neurologic damage can result. Evidence suggests that this damage can occur before the onset of overt clinical signs of the disease (760).

## Sickle Cell Anemia

Sickle cell anemia is caused by an abnormality in the beta globin chain of the oxygen-carrying molecule, hemoglobin, in the blood. The red blood cells become distorted in shape and have shorter useful lifespans in the circulatory system. The misshapen cells block small blood vessels, obstructing the flow of blood, leading to cell death in various organs in the body. The disease occurs in about 1 in 500 U.S. black newborns and also with relatively high frequency among people of Mediterranean and Middle Eastern descent.

The clinical course of sickle cell anemia is quite variable. Appearing normal at birth, infants with this disease may seem to be in pain and act irritable without apparent reason. Some infants with sickle cell anemia succumb to severe bacterial infections, such as septicemia, pneumonia, or meningitis in the first few years of life. When these infections occur, they can develop without overt initial symptoms or fever and may proceed rapidly, with death occurring in less than 12 hours. Overall, there may be a 10- to 20-percent mortality rate in infants with sickle cell anemia in the first year of life. **Between 6 months and 1 year of age, chronic hemolytic anemia** may begin to manifest itself, leading to long-term, debilitating complications

that affect general health, growth, and development. Painful episodes of vase-occlusive crises (i.e., obstruction of veins and arteries) are the hallmark of the disease. For the majority of infants with sickle cell anemia who survive infancy, there is wide variability in severity of the disease through childhood, adolescence, and adulthood.

There is no overall treatment or cure for sickle cell anemia. It is possible to prevent the occurrence of overwhelming infection in children with the disease by administering prophylactic penicillin beginning by 4 months of age and continuing beyond age 3. Such treatment has been shown to reduce overall morbidity and mortality from infection in affected infants (198,747). Blood transfusions may be needed at various times to increase oxygen-carrying capacity. Ongoing monitoring and treatment of acute crises may be necessary to maintain an adequate quality of life.

Newborn screening for sickle cell anemia, allowing administration of antibiotics before the disease would normally have been diagnosed, may be lifesaving for a certain percentage of infants with the disease. For others, it may allow for improved medical care by directing these infants to specialized treatment centers at an earlier time,

## Cystic Fibrosis

Cystic fibrosis is a disorder of exocrine glands, characterized by thick secretions obstructing different organs, particularly the lungs, sweat glands, and pancreas. Its underlying cause is unknown, but it seems to involve a defect in chloride transport across cell membranes. It is thought to be the most common potentially fatal genetic disease in the Caucasian population, with an incidence of about 1 in 2,000 live births.

In most infants with cystic fibrosis, the disease begins its course with nonspecific symptoms. Some infants are detected at birth because of a specific form of bowel obstruction (meconium ileus). Most cases, however, manifest in infancy or early childhood with failure to thrive, diarrhea due to poor digestion and absorption of food, and persistent or recurrent signs of lung infections, which are due to thick sticky mucus in the bronchial tree.

Children with cystic fibrosis **have** no associated mental disabilities. Their overall physical problems—poor growth, intestinal malabsorption, recurrent pneumonias, and chronic respiratory disease—are progressive and disabling, however, and have social as well as medical consequences. Improvements in medical care and increased awareness of the disease have led to better survival in children with cystic fibrosis. Although death in childhood still occurs as a result of

the disease, the average lifespan of affected individuals who have been treated through normal medical channels is now above **20 years**.

**Current treatment** for cystic fibrosis is partially preventive and partially palliative. The inability to secrete normal amounts of digestive enzymes into the intestines (preventing the absorption of protein and fat from the diet) leads to nutritional deficiencies that can be corrected with supplemental vitamins and pancreatic replacement therapy if the disease is diagnosed sufficiently early in life. Salt supplements may be needed to counteract excessive salt loss in sweat, and antibiotics administered prophylactically can reduce incidence and effects of infections. Respiratory dysfunction eventually predominates, however, and generally determines the severity of the case. Obstructive lung disease with heart failure is the most common cause of death in individuals with cystic fibrosis, and at present, there is no cure for this problem. Whether early diagnosis and treatment will improve the long-term prognosis for patients with cystic fibrosis is still uncertain.

### **Congenital Adrenal Hyperplasia**

The most common form of CAH, resulting from a deficiency of the enzyme 21-hydroxylase (**276**) **affects clinical manifestations** in infant girls more dramatically than in infant boys. The typical female patient with the disease is born with masculinization of the external genitalia and may be sent home from the hospital as a male, while the typical male infant with the disease has normal genitalia at birth. In the first week of life, a significant proportion of patients with the salt-

wasting form of CAH (about one-half of all patients with the disease) undergo a severe salt-losing crisis that is rapidly fatal if not treated immediately.

Some infant girls with CAH who survive the first few weeks of life require reconstructive surgery, but if the underlying cause of their disease is not treated, they will continue to masculinize and may go on to have short adult stature, and no breast development or menstruation. In contrast, the typical infant boy with CAH appears to develop normally in infancy, but enters puberty prematurely, resulting in short adult stature.

CAH results from a deficiency of one or another of the enzymes in the adrenal cortex that are required for normal steroid hormone synthesis. This prevents the synthesis of cortisol, leading to excessive androgen synthesis. In some forms of CAH, aldosterone production is also affected. These hormones are necessary for the body to manage stress and control salt content of tissues. The symptoms of CAH result from a deficiency of some hormones and an overproduction of others.

The prevalence of classic salt-wasting CAH ranges from approximately 1 in 11,500 to 1 in 18,250 (276, 609), but varies widely in different populations (e.g., it occurs in 1 in 3,000 live births in Alaskan Eskimos). Newborn screening can be particularly useful for detecting and treating the salt-wasting form of CAH, since infants with this form of the disease are at risk for sudden death very soon after birth if they are not properly treated. Infants with either form of the disease require replacement of missing hormones (hydrocortisone with or without mineralocorticoids) to prevent excessive androgen production and its effects on growth and reproductive functioning.

# Data and Methods Used in OTA's Cost-Effectiveness Analysis of Strategies for Newborn Screening

---

This appendix presents information on sources of data and methods of calculation used in OTA's cost-effectiveness analysis of strategies for newborn screening, which is presented in chapter 5. That chapter considered seven different strategies offering different combinations of tests for phenylketonuria (PKU), congenital hypothyroidism, galactosemia, maple syrup urine disease (MSUD), and homocystinuria. Information about the detection and treatment of these and other disorders is presented in appendix H.

### Specimen Collection Costs

The vast majority of first blood specimens for newborn screening are collected in the hospital before a newborn infant is discharged. The only published data on costs of specimen collection in the hospital are from a time study at three Wisconsin hospitals (47). The average cost of first specimen collection in that study was found to be \$4.60 (in 1982 dollars), which included the cost of drawing blood, administration, medical recordkeeping, supplies, billing, and overhead. Using the medical care component of the Consumer Price Index, OTA inflated the \$4.60 from this study to its 1986 value, \$6.07, and used this to represent the cost of first specimen collection in the base case analysis.

Most second specimens are likely to be collected outside the hospital, possibly during the first recommended well-child visit at the physician's office or clinic, and would therefore entail different costs than first specimen collection. The recommended schedule of well-child visits offered by the American Academy of Pediatrics Committee on Practice and Ambulatory Medicine specifies that infants should be examined by a physician during the first month after birth and that tests for PKU and congenital hypothyroidism should be done at about 2 weeks of age (20).<sup>1</sup> Second specimen collection performed during such visits would then be additional to the services performed during the visit, and would not require a separate visit to the physician's office solely for that purpose. The assumption in OTA's analysis, therefore, was that the costs of col-

lecting a second specimen would not normally include the separate cost of an office visit to the physician. Data on the costs of specimen collection performed in a physician's office are not available, so it is unknown whether these costs are greater or less than the collection costs in a hospital.<sup>2</sup> For OTA's analysis, it was assumed that the cost of collecting a second specimen would be similar to the cost of collecting the first.<sup>3</sup>

### Laboratory Testing and Followup Costs

OTA estimated the resource costs of newborn screening for PKU, congenital hypothyroidism, galactosemia, MSUD, and homocystinuria using data provided by three State newborn screening programs: Washington (609), Wisconsin (259), and Iowa (256). OTA asked the directors of each of these programs to estimate the cost of resources (divided into personnel time, amounts of supplies and reagents, and major equipment) applied to laboratory testing and followup for each of these conditions, and requested an approximate breakdown of cost items in these categories. The results reflect best available estimates of the value of resources used to screen for these various disorders. Using these data, OTA made an effort to include only the appropriate types of data in each category and to delete irrelevant and duplicative items.

Based on these three States' data, the combined cost of laboratory detection and followup for PKU and congenital hypothyroidism<sup>4</sup> ranged from **\$3.88 to \$8.16** per specimen, giving a mean of **\$5.65, which was**

---

<sup>1</sup>Both, however, may be different from **actual charges** that families pay for the service. Since charges affect only incomes and budgets, rather than resource costs, they are not considered here.

<sup>2</sup>In practice, the cost of second specimen collection in a physician's office may actually be less than in a hospital. For comparison, under the Medicare program, physicians are currently reimbursed \$3.00 for handling a blood specimen that will be sent to an outside laboratory for analysis (438). Moreover, newborn blood specimens are collected onto filter paper cards, which are generally easier to handle and transport than whole blood collected in tubes, so handling a newborn screening specimen may be less costly than handling other blood specimens collected by the physician, and can actually be transported by regular mail service.

<sup>3</sup>Since screening for PKU and congenital hypothyroidism is available in all States, OTA combined the costs of screening for these conditions into a single estimate.

---

<sup>4</sup>For more information on the recommended frequency and content of well-child care, see ch. 6 of this report

used in OTA's base case analysis to estimate the cost of detection and followup of PKU and congenital hypothyroidism. The cost of laboratory detection and followup for galactosemia ranged from \$1.25 to \$1.60 per specimen in these data, and for MSUD, from \$0.98 to \$1.84 per specimen. OTA's base case analysis used the simple averages of these estimates: \$1.43 for galactosemia and \$1.41 for MSUD. Only one estimate for homocystinuria testing and followup was available—\$0.93 per specimen—and that was used in OTA's base case analysis.

The differences among the three State newborn screening programs in estimated screening and followup costs may result from actual technical differences in testing and from different ways of estimating amounts and costs of resources needed for testing and followup. In addition, a large portion of their estimated costs may be fixed costs, which do not change with changes in the number of specimens analyzed. Further, costs of equipment and personnel may, to some extent, be fixed costs in screening programs, while costs of supplies and reagents (generally the least costly components of testing) would be more closely related to the specimen volume. Because some percentage of costs is fixed, unit costs in small volume programs are not likely to correspond to unit costs in large volume programs.

Another possible cause of the variability in unit costs among these data may be real differences in organization and staffing among the programs, as well as artificial differences in reporting (e.g., inclusions of some types of costs in one program and not another) or differing methods for allocating common or overhead costs. The result is a combination of methodologies. The costs of laboratory equipment, for example, were particularly difficult to assess, since ways of determining equipment costs involved different interpretations of what would be considered "major" equipment and different ways of valuing them.

### Treatment Costs for Cases Detected by Newborn Screening

Estimates of treatment costs per case of PKU and congenital hypothyroidism used in OTA's analysis are shown in table I-1. The undiscounted costs and their 1982 values were derived from two studies in Wisconsin (46,47). The base case and the best case analyses applied a 7-percent discount rate to these costs, while the worst case analysis applied a 10-percent discount rate.

**Table I-1.—Costs of Treatment for PKU and Congenital Hypothyroidism**

Year of cost	Undiscounted costs		Discounted costs	
	total costs	at 70/0	total costs	at 100/0
<b>Phenylketonuria: age 0-20</b>				
1982 dollars . . . .	\$81,600 <sup>a</sup>	\$40,830	\$32,350	
1986 dollars . . . .		\$53,855	\$42,670	
<b>Congenital hypothyroidism: age 0-70</b>				
1982 dollars . . . .	\$11,240 <sup>b</sup>	\$ 3,230	\$ 2,270	
1986 dollars . . . .		\$ 4,260	\$ 3,588	

<sup>a</sup>H.S. Barden, R. Kessel, and V. E. Schuett, "The Costs and Benefits Of Screening for PKU in Wisconsin," *Social Biology* 31(12) 1-17, 1984

<sup>b</sup>H.S. Barden and R. Kessel, "The Costs and Benefits of Screening for Congenital Hypothyroidism in Wisconsin," *Social Biology* 31(3-41) 185200 1984

SOURCE Office of Technology Assessment, 1988

Treatment costs for PKU include the following costs spread over the first 20 years of a patient's life<sup>5</sup>: a low-phenylalanine dietary supplement beginning in the first few weeks of life<sup>6</sup> (averaging \$2,914 per year, undiscounted 1982 dollars) and clinical followup—including blood testing, travel, and consultation with physicians, nutritionists, and genetic counselors. Treatment costs for congenital hypothyroidism include the following costs: clinical followup—including laboratory testing, physician fees, travel—and medication (thyroxine supplements cost approximately \$20 per year, undiscounted 1982 dollars).

OTA inflated these estimates of PKU and congenital hypothyroidism treatment costs to their 1986 values using the medical care component of the Consumer Price Index. In 1986 dollars, total costs of PKU treatment were estimated at \$53,855 using a 7-percent discount rate and \$42,670 using a 10-percent discount rate. Total costs of congenital hypothyroidism treatment were estimated at \$4,260 and \$3,488, respectively.

Comparable data on treatment costs for galactosemia, MSUD, and homocystinuria are not available in

<sup>5</sup>The length of time that a given individual with PKU must remain on the diet is still unknown, but preliminary information suggests that beyond age 20 or so, a high phenylalanine level in the blood has little or no effect on mental capacities. However, there may be seizures, personality changes, and other effects of discontinuing the diet. Women with PKU should be advised to continue the diet during their childbearing years to minimize the risk of fetal damage. Long-term collaborative studies are in progress to determine if there is an age at which it is safe to discontinue the diet (346).

<sup>6</sup>Since the low-phenylalanine products are dietary supplements rather than a complete alternative food source, and individuals with PKU can eat natural foods that have little or no phenylalanine (though these may be somewhat more expensive than other foods), the costs of a normal diet are not subtracted from the cost of a PKU diet.

<sup>7</sup>Ideally, travel costs should have been omitted from this analysis, since they are not costs to the health care sector. Since they contributed only \$660 undiscounted 1982 costs to the total cost of PKU treatment over 20 years and \$780 to the costs of congenital hypothyroidism treatment over 70 years, however, they are not likely to affect the estimate of treatment costs.

the literature. Children with galactosemia require no special supplemental diet—just avoidance of foods containing galactose. In OTA's analysis, costs of treatment for galactosemia are approximated by the reported costs of treatment for congenital hypothyroidism (46), which include minor costs for medication and long-term costs of clinical care and monitoring.

Treatment costs for MSUD and homocystinuria in OTA's analysis are approximated by the costs of long-term PKU treatment (47), because patients with MSUD or homocystinuria require a special diet similar to the PKU diet and also require long-term clinical care and monitoring. The diets for MSUD and homocystinuria may be more costly than the PKU diet (and patients with MSUD may have more crises requiring hospitalization, so their treatment may be more expensive than treatment for patients with PKU); but since the lifespan of treated patients with these diseases is unknown, the difference in costs is unknown. In the absence of firm data, OTA assumed that the costs of PKU treatment approximate the cost of MSUD and homocystinuria treatment, and the cost of congenital hypothyroidism treatment approximate the cost of galactosemia treatment.

### Health Care Costs Averted by Newborn Screening and Treatment

Individuals with untreated PKU or congenital hypothyroidism, who are mentally retarded in the majority

of cases, obviously lead lives that are fundamentally different from those of afflicted individuals in whom the disease has been treated. The societal costs of mental retardation include the added costs of residential care and special education, as well as the loss to society of some potential contribution the afflicted individual might have made with a normal level of intelligence. Some costs may also be borne by the family of the individual with untreated PKU or congenital hypothyroidism (e.g., reduced earning capacity of one or both parents due to the increased demands of raising a mentally retarded child compared to a normal child).

The costs of untreated PKU and congenital hypothyroidism in OTA's analysis, however, include only the major costs to the health care sector broadly defined—in particular, the costs of custodial care and institutionalization and the cost of special education for untreated individuals beyond that required for normal individuals. The costs avoided by newborn screening include the lifelong costs of custodial care and special education associated with untreated disease. The costs averted by treatment of PKU are shown in table I-2, and those averted by treatment of congenital hypothyroidism are shown in table I-3.

In calculating these costs, it is necessary to estimate the expected levels of mental retardation and average survival in untreated individuals. For PKU, OTA used the assumptions of Barden and colleagues that 64 percent of individuals with untreated PKU would be in-

**Table 1.2.—Costs of Residential Care and Special Education Averted by Newborn Screening for PKU**

Component of cost	Lifetime undiscounted cost per person	Lifetime cost discounted 7% <sup>a</sup>		Lifetime cost discounted 10% <sup>a</sup>	
		Total cost	PKU cost <sup>b</sup>	Total cost	PKU cost <sup>b</sup>
<b>Residential care and services</b>					
a. Institutional care (assumes 64% of PKU cases institutionalized from age 5 to 70) . . . . .	\$913,250	\$259,000	\$166,000	\$181,700	\$116,288
b. Foster care (assumes 18% of PKU cases receive foster care from age 5 to 20) . . . . .	\$67,000	\$31,740	\$ 6,000	\$23,950	\$ 4,311
c. Adult residential care and services (assumes 36% of PKU cases use adult residential care and services from age 20 to 70) . . . . .	\$176,400	\$ 20,010	\$ 7,000	\$ 9,280	\$ 3,341
<b>Special education</b> (by degree of mental retardation)					
a. Severe (64% of PKU cases) . . . . .	\$ 84,110	\$42,020	\$ 27,000	\$ 32,470	\$ 20,781
b. Moderate (20% of PKU cases) . . . . .	\$ 75,530	\$36,660	\$ 7,000	\$28,040	\$ 5,608
c. Mild (16% of PKU cases) . . . . .	\$ 43,270	\$ 22,120	\$ 4,000	\$ 17,250	\$ 2,760
Total cost per case in 1982 dollars . . . . .			\$217,000		\$153,089
Total cost per case in 1986 dollars <sup>b</sup> . . . . .			\$246,512		\$173,909

<sup>a</sup>Corresponds to the average cost per child with PKU, which is a function of the percent of PKU individuals requiring institutionalization (see text for explanation)

<sup>b</sup>Inflated from 1982 to 1986 dollars using the Consumer Price Index of 13.6% for this period.

SOURCE: Adapted from H.S.Barden and R.Kessel, "The Costs and Benefits of Screening for Congenital Hypothyroidism in Wisconsin," *Social Biology* 31(3-4) 185-200, 1984



**Table I-3.—Costs of Residential Care and Special Education Averted by Newborn Screening for Congenital Hypothyroidism (CH)**

Component of cost	Lifetime undiscounted cost per person	Lifetime cost discounted 7%		Lifetime cost discounted 10%	
		Total cost	CH cost <sup>a</sup>	Total cost	CH Cost <sup>a</sup>
<b>Residential care and services</b>					
a. Institutional care (assumes 15% of CH cases institutionalized from age 5 to 70) . . . . .	\$1,845,500	<b>\$324,600</b>	<b>\$48,690</b>	\$205,400	\$30,810
b. Foster care (assumes 25% of CH cases receive foster care from age 5 to 20) . . . . .	\$ 46,680	<b>\$ 32,420</b>	<b>\$ 8,110</b>	\$ 24,250	\$ 6,063
c. Adult residential care and services (assumes 40% of CH cases use adult residential care and services from age 20 to 70) . . . . .	\$ 513,480	<b>\$ 41,280</b>	<b>\$ 16,510</b>	\$ 17,590	\$ 7,036
<b>Special education</b> (by degree of mental retardation)					
a. Severe (15% of CH cases) . . . . .	\$ 87,590	<b>\$ 42,690</b>	<b>\$ 6,400</b>	\$ 32,700	\$ 4,905
b. Moderate (25% of CH cases) . . . . .	\$ 79,330	<b>\$ 37,520</b>	<b>\$ 9,380</b>	\$ 28,440	\$ 7,110
c. Mild (40% of CH cases) . . . . .	\$ 44,820	<b>\$ 22,370</b>	<b>\$ 8,950</b>	\$ 17,300	\$ 6,920
Total cost per case in 1982 dollars, . . . . .			<b>\$ 98,040</b>		\$62,844
Total cost per case in 1986 dollars <sup>a</sup> , . . . . .			\$111,373		\$71,391

<sup>a</sup>Inflated from 1982 to 1986 using the Consumer Price Index of 136% for this period

SOURCE Adapted from H S Barden and R Kessel 'The Costs and Benefits of Screening for Congenital Hypothyroidism in Wisconsin' *Social Biology* 31(3-4):185-200 1984

stitutionalized from age 5 for life, 18 percent would require foster care from age 5 to 20, and 36 percent would require adult residential support services (47). The net average costs of residential care and special education were derived from this same study (47) (given in 1982 dollars and discounted at 7 and 10 percent) and inflated to 1986 values for the OTA analysis. To adjust for the expected lifespan of untreated individuals with PKU, OTA used survival rates based on a study of the age at death for institutionalized individuals with PKU (174); that study generally agrees with previous studies (85).

Costs of untreated congenital hypothyroidism, as in PKU, derive mainly from the attendant costs of mental retardation, but the spectrum of severity is different for congenital hypothyroidism. In these calculations, OTA used the assumptions of Barden and colleagues that 15 percent of individuals with untreated congenital hypothyroidism would be institutionalized from age 5 for life, 25 percent would require foster care from age 5 to 20, and 40 percent would require adult care and services from age 20 for life (46). These costs were combined with the additional cost of special education (46) (given in 1982 dollars and discounted at 7 and 10 percent) and inflated to 1986 values. To take into account the lifespan of individuals with congenital hypothyroidism, survival was estimated to be 95 percent of normal survival rates (368).

The costs of untreated galactosemia, MSUD, or homocystinuria are more difficult to quantify. No data

are currently available to estimate the cost of the progressive deterioration and almost certain death, as occur in the majority of cases of galactosemia or MSUD, or the long-term disabilities and risk of premature death, as in cases of homocystinuria. For that reason, OTA's analysis did not quantify costs of untreated galactosemia, MSUD, or homocystinuria.

The cost of institutional care for the mentally retarded was estimated at \$36,500 per year per patient in 1982 dollars (47). This cost was derived from an estimate of the Wisconsin Center for Developmental Disabilities and compared with \$32,759, the yearly cost of residential care derived from national data (362). In Barden's analysis, \$4,000 was subtracted from the annual cost of institutionalization to account for the costs of care for a normal individual (603).

OTA calculated the costs of institutionalization per patient using the annual cost of institutional care per patient, the estimated survival of individuals with PKU or congenital hypothyroidism, and the percentage of survivors requiring institutional care. The costs of institutionalization reported by Barden et al. (47) were inflated to 1986 dollars in OTA's analysis using the overall Consumer Price Index.

The annual cost of foster care was estimated to be \$9,000, or \$5,000 if personal consumption costs are deducted (47). In PKU, the discounted cost of foster care amounts to \$32,000 (in 1982 dollars) over the period from age 5 to 20 discounted at a 7-percent rate.

The annual cost of adult residential care and services was estimated at \$12,000 (1982 dollars) per person, but this does not include costs of associated community services, special transportation, or vocational rehabilitation (47). For individuals with untreated PKU, the cost of adult residential care services is low because of the low survival rate to adulthood.

The added costs of special education for survivors were derived from a nationwide study conducted by the Rand Corp. (313) and expressed in 1982 dollars in the studies by Barden and colleagues (46,47). The original costs in the Rand report were expressed in 1978 dollars and were inflated by Barden et al. to 1982 dollars using the GNP deflator. This method increased these costs by 34 percent for this period, whereas the overall Consumer Price Index would have inflated them by 48 percent for this same period (721).<sup>8</sup> For OTA's analysis, the costs of institutionalization, foster care, adult residential care and services, and spe-

<sup>8</sup>This difference in inflation methods for 4 of the 8 years for which they are adjusted is not likely to alter the total discounted cost of special education in these cases.

cial education were inflated to 1986 levels using the overall Consumer Price Index.

### **Calculation of Net Costs and Effectiveness in the Base Case and Sensitivity Analyses**

The calculation that OTA used to estimate the overall costs or savings and number of cases detected per 100,000 infants screened is shown by the figures for Strategy I (a single specimen to test for both PKU and congenital hypothyroidism) in table I-4. The total cost of newborn screening and treatment, consisting of the costs of specimen collection, lab testing, followup, and treatment, amounts to \$1,716,000 per 100,000 infants screened to identify and treat approximately 34 cases of PKU and congenital hypothyroidism when compared to no screening at all. The expected cost averted by such screening and treatment amounts to \$4,935,000 per 100,000 infants screened, yielding a net savings of \$3,219,000.

**Table 1-4.—Costs and Effectiveness of Seven Newborn Screening Strategies Compared to No Screening (1986 dollars)**

	Strategy I	Strategy II	Strategy III	Strategy IV	Strategy V	Strategy VI	Strategy VII
1st specimen	PKU + CH	PKU + CH	PKU + CH	PKU + CH	PKU + CH	PKU, CH, GA, MSUD	PKU, CH, GA, MSUD
2nd specimen.	None	PKU + CH on all Infants	PKU + CH on early discharge Infants only	CH only on all infants	PKU, CH, HC on all Infants	None	PKU, CH, and HC on all infants
1 Specimen-collection cost per 100,000 Infants screened	\$ 607,000	\$1,214,000	\$ 858,298	\$1,214,000	\$1,214,000	\$ 607,000	\$1,214,000
2 Lab testing and followup cost per 100,000 Infants screened	\$ 565,000	\$1,130,000	\$ 799,910	\$ 875,000	\$1,223,000	\$ 849,000	\$1,507,000
3 Number of cases detected per 100,000 infants screened	34.6	366	359	363	371	364	389
4 Treatment cost for cases detected among 100,000 Infants screened	\$ 544,000	\$ 568,000	\$ 560,000	\$ 51,000	\$ 594,000	\$ 572,000	\$ 622,000
5 Total cost of screening and treatment [1+2+4]	\$1,716,000	\$2,912,000	\$2,217,000	\$2,640,000	\$3,031,000	\$2,028,000	\$3,343,000
6 Costs averted [custodial and special education costs associated with untreated disease]	\$4,935,000	\$5,198,000	\$5,106,000	\$512,000	\$5,198,000	\$4,935,000	\$5,198,000

A) abbreviations: PKU = phenylketonuria CH = congenital hypothyroidism HC = homocystinuria GA = galactosemia MSUD = maple syrup urine disease

SOURCE: Office of Technology Assessment 1988

## Appendix J

# Effectiveness of Well-Child Care and Cost-Effectiveness of Childhood Immunization

---

As a supplement to the discussion of well-child care in chapter 6, this appendix presents nine tables summarizing studies of the effectiveness of well-child care and the cost-effectiveness of childhood immunizations. The first five tables summarize various types of studies of the effectiveness of well-child care as a whole:

- studies of varying the frequency of child health supervision visits,
- studies of comprehensive care programs,
- studies of Medicaid's Early and Periodic Screening, Diagnosis, and Treatment (EPSDT) program,
- studies of health outcomes in alternative health delivery and insurance systems, and
- studies of the effects of well-child care on developmental outcomes.

Three subsequent tables summarize studies examining the effectiveness of three specific components of well-child care:

- the physical examination,
- the Denver Developmental Screening Test (DDST), and
- anticipatory guidance for child safety restraint use.

The last table is a summary of the studies evaluating the cost-effectiveness of childhood vaccination programs.

**Table J-1.—Effectiveness of Well-Child Care as a Whole: Studies of Varying the Frequency of Well-Child Care Visits**

Author	Years data collected	Study population	Study design	Sample size	Intervention	Outcome measures	Results	Comments
Gilbert, et al 1984 <sup>a</sup>	1979-80	Ontario, low risk	RCT	214 experimental 252 control	Decrease the number of well-child visit from 10 to 5 in first 2 years	Number of physical abnormalities Number of undetected abnormalities Bayley HOME Maternal anxiety Satisfaction with care	No differences detected	Small difference in actual number of well-child visits—6.19 in experimental group and 7.89 in control
Hoekelman 1975 <sup>b</sup>	1971-72	Rochester, low biologic risk—clinic and private	RCT	125 experimental 121 control	Decrease number of well-child visits from 6 to 3 in first year	Knowledge Satisfaction with care Compliance Utilization Number of undetected abnormalities	No differences detected	1 Extra visits occurred due to contact with nurses 2 Extra visits scheduled for experimental clinic patients 2 Inadequate measures of developmental/behavioral outcomes 3 Inadequate power for 50% difference in frequency of physical abnormalities 4 Outcome assessment not blinded to study group

Abbreviations: RCT = randomized clinical trial; HOME = tests of cognitive development in the home

<sup>a</sup>J.R. Gilbert, W. Feldman, L. Seigal, et al., "How Many Well-Baby Visits Are Necessary in the First 2 Years of Life?" *Can Med Assoc J* 130:857-881, 1984

<sup>b</sup>R.A. Hoekelman, "What Constitutes Adequate Well-Baby Care," *Pediatrics* 55:313-325, 1975

The sample for this study came from two sources: a private practice and a clinic. Those clinic patients who were randomized to receive a lower frequency of well-child visits were nonetheless scheduled for additional well-child (immunization only) visits by the nurses or physicians of the clinic.

SOURCE: Office of Technology Assessment, 1988, based on a background paper by C. J. Homer, "Evaluation of the Evidence on the Effectiveness of Well-Child Care Services for Children," prepared for the Office of Technology Assessment, U.S. Congress, Washington, DC, April 1987.

**Table J-2.—Effectiveness of Well-Child Care as a Whole: Studies of Comprehensive Care Programs**

Author	Years data collected	Study population	Study design	Sample size	Intervention	Outcome measures	Results	Comments
Gordis and Markowitz 1971 <sup>a</sup>	1967-70	Baltimore primiparous <18 years	RCT	120 experimental 117 control	Comprehensive care (MD, RN, MSW- free) v usual care	Infant mortality hospitalization clinic/EW visits height/weight < 10% number of Immunized	No differences	1. Inadequate power 2. Inadequate morbidity and developmental measures
Kaplan, et al 1972 <sup>b</sup>	1969-70	Pittsburgh attendees 2 schools in low-income neighborhood (pre-school and school-age children)	Cross sectional	525 experimental 700 control	Enrollment in Children & Youth Health project—daytime program, peals, MSW, RN, public health	School attendance	Small, statistically significant difference with + effect of enrollment status (3.2 days). likely self-selection of healthier children into program (selection bias)	
Moore, and Frank 1973 <sup>c</sup>	1968-71	Charlestown school-children undergoing complete physical exam	Cross sectional	991 total 3 groups	Degree of participation in health center—multi-disciplinary, comprehensive, free physical exam	Change in absenteeism	No significant change in absenteeism with participation; trend to increased absence	1 Effect of both health center utilization and absenteeism likely confounded by health status 2 Secular trend existed towards increased absenteeism 3 Possible selection bias (no data comparing intervention and control groups)
Alpert, et al 1976 <sup>d</sup>	1964-68	Boston, Children's Hospital—poor, no other MD live near hospital	RCT	173 experimental 189 control	Comprehensive medical care program—MD, RN, MSW, v usual care	Child health index utilization, sickness and drug days, satisfaction, cost, process use of preventive services and Immunizations	No significant difference any morbidity measure, similar frequency outpatient visit with more preventive visits; no significant difference overall hospitalization—more surgical, fewer acute, improved satisfaction with wait and professional relationships, improved process measures	1 Not a representative sample of a given community 2 Eligibility not clear 3 30% dropout—probably not biasing 4 Comparative nature experimental and control groups not documented 5. Specific morbidity measures not noted in report 6. No developmental measures 7 Multiple comparisons for statistical testing 8 Introduction of Medicaid may have minimized effect
Rogers, et al 1974 <sup>e</sup>	1970-82	Fort Defiance Indian reservation Arizona—live born infants	Pseudo-randomized trial	116 experimental 119 control	Intensive followup and home visits v. usual care	Infant mortality; health appraisal age 1, uncorrected abnormalities, global health assessment, Hct, DDST (not reported), hospitalizations, and outpatient visits	No significant differences	1 Inadequate power mortality analysis 2 Adequate power for some morbidity outcomes, appropriateness uncertain 3 Confounding of case finding and better care 4 No behavioral outcomes

Augustin, et al 1973 <sup>1</sup>	1970-71	NYC children enrolled in Montefiore-Morisania C&Y project	Hybrid design—1st year enrollees compared to 2nd year	40 total	Not described	Number of illness visits to clinic during 2nd year of program participation compared to age matched first year enrollees hospital days per registrant	35% decrease out-patient visits, decrease in hospitalization rates from O 36 to O 102	1 No description of population 2 No description of program 3 Inadequate control group 4 Time of enrollment and acute needs related (confounded)
Gordis 1973 <sup>9</sup>	1968-70	Baltimore residents 5-14 yr in 1) census tracts with comprehensive health centers and 2) adjacent, comparable, and all other tracts	Ecologic <sup>1</sup>	Not relevant 35,068 eligible Incidence 13 5/100,000	Existence of comprehensive care program in tract	Rheumatic fever incidence (rates)	60% decline (p<.005) in rheumatic fever rates in eligible census tracts	1 Ecologic study <sup>1</sup> 2 Not specifically related to child health supervision
Klein, et al 1973	1968-70	Rochester 1 Catchment area residents, 2 Health center users	1. Ecologic 2 Cross sectional	1 8,000 experimental, 7,000 control 2 1,500 to 3,300 users, 6,000 to 4,750 nonusers	Comprehensive, multi-specialty group practice 1 In tract v not in tract 2 Users v nonusers	Hospitalization rates and length of stay	1 Lower hospital admission rates and LOS in control tracts throughout study 2 Users had lower hospitalization rates than nonusers and lower LOS than nonusers or control group	1 Limitations in value of hospitalization rates as outcome 2 Selection bias in use of health center (initial users were lower risk segment of target population)
Briscoe, et al , 1980 <sup>1</sup>	1975 1977	Hazard, Kentucky Sample of all children born at ARH hospital, matched to children born at comparable facility	Cohort study—experimental and control groups geographically separate	65 pairs from 177 pairs in original group, 79 pairs in new study group	Home visits (7) for counseling, support, education, and advocacy. plus well-child care	Health status physical exam, otitis media, hemoglobin count, iron deficiency, utilization-admissions and out-patient/EW visits	No difference in health status measures, non-significant trend to decreased utilization in experimental group but home visits not included	1 Inadequate control population (increased distance to MD for control group, better insurance for intervention group) 2 Inadequate power to detect differences in hospitalization 3 No behavioral outcomes

Abbreviations EW = emergency ward, LOS = length of stay, MD = physician, MSW = medical social worker, RCT = randomized clinical trial, RN = registered nurse

<sup>1</sup>L. Gordis and M. Markowitz, "Evaluation of the Effectiveness of Comprehensive and Continuous Pediatric Care," *Pediatrics* 48:766, 1971.

<sup>2</sup>P. Kaplan, L. V. Lave, and S. Leinhardt, "The Efficacy of a Comprehensive Health Care Project: An Empirical Analysis," *Am J Public Health* 62:924-930, 1972

<sup>3</sup>G. Moore and K. Frank, "comprehensive Health Services for Children: An Exploratory Study Of Benefit," *pediatrics* 51 17-21, 1973

<sup>4</sup>J. Alpert, L. S. Robertson, J. K. Kosa, et al, "Delivery of Health Care for Children: Report of an Experiment," *Pediatrics* 57:917-930, 1976

<sup>5</sup>K. D. Rogers, R. Ernst, I. Shulman, et al, "Effectiveness of Aggressive Followup on Navajo Infant Health and Medical Care Use," *Pediatrics* 53 "721-725 1974

<sup>6</sup>M. Augustin, E. Stevens, and D. Hicks, "An Evaluation of the Effectiveness of a Children and Youth Project," *Health Services Report* 88 "942-946, 1973

<sup>7</sup>L. Gordis, "Effectiveness of Comprehensive-Care Programs in Preventing Rheumatic Fever," *N Eng J Med* 289:331-335, 1973

<sup>8</sup>M. Klein, K. Roghmann, K. Woodward, et al, "The Impact of the Rochester Neighborhood Health Center on Hospitalization of Children, 1968 to 1970," *Pediatrics* 51 "633-639, 1973

<sup>9</sup>M. E. Briscoe, D. L. Hochstrasser, G. W. Somes, et al, "Followup Study of the Impact of a Rural Preventive Care Outreach Program on Children's Health and Use of Medical Services." *Am J Public Health* 70:151-156, 1960.

<sup>10</sup>This is a generic problem of these evaluation studies but especially strong here

<sup>11</sup>ecologic studies individual experience is not directly measured, rather, such experience is inferred from measures of aggregate experience. A problem with such studies is that the individuals may not experience the exposures attributed to them by virtue of their residence or group membership

SOURCE" Office of Technology Assessment, 1988, based on a background paper by C. J. Homer, "Evaluation of the Evidence on the Effectiveness of Well-Child Care Services for Children," prepared for the Office of Technology Assessment, U.S. Congress, Washington, DC, April 1987

**Table J-3.—Effectiveness of Well-Child Care as a Whole: Evaluations of Medicaid’s Early Periodic Screening, Diagnosis, and Treatment (EPSDT) Program**

Author	Years data collected	Study population	Study design	Sample size	Intervention	Outcome measures	Results	Comments
Irwin and Conroy-Hughes, 1982 <sup>a</sup>	1973-80	S E Pennsylvania EPSDT eligible >18 mo. at 1st screen, screened at 2 yr	Before/after with separate controls for each time	1,831 children	Participation in EPSDT program	1 Identification of an abnormal condition requiring treatment 2 Number of treatable conditions identified, standardized for number of conditions tested	1 No difference in crude rates 2 <b>When adjusted</b> for secular trend of increased identification rates, rescreening was associated with a 26% decrease	1 Results based on speculate adjustment 2 No specific information on importance of conditions 3 No individual health status measures
Keller, 1983 <sup>b</sup>	1979	Michigan—population eligible for EPSDT entire year	1 Repeated prevalence 2 Cross section users v nonusers	1 16,000 random sample 2 10,000 users, 6,000 nonusers	Participation in EPSDT program	1 Referral rates 2 Costs for participants v nonparticipants, with and without administrative costs	1 Decreased referral rates with increased screening 2 No consistent change in costs with increased numbers of screenings 3. Participants cost less than non-participants	1 <b>Same criticisms as comments 2 and 3 above</b> 2. <b>Nonparticipants are likely different than participants (selection bias)—e.g., nonscreened Medicaid eligible may have “spent down” to get onto Medicaid roles</b>
Reis, et al., 1984 <sup>c</sup>	1972-79		Review of six EPSDT demonstration/evaluation projects					1 Great variability in proportion of eligible population screened (14-85%) 2 Variation in case finding rates (6-18%) 3 Although 50-80% of those identified with problems were treated, only 7-18% were judged to achieve maximum benefit 4 Large proportion of those diagnosed were not previously identified

<sup>a</sup>P. H. Irwin and R. Conroy-Hughes. "EPSDT Impact on Health Status: Estimates Based on Secondary Analysis of Administratively Generated Data," *Medical Care* 20:216-234, 1982.

<sup>b</sup>W. Keller. "Study of Selected Outcomes of the Early and Periodic Screening, Diagnosis, and Treatment Program in Michigan," *Public Health Reports* 98:110-119, 1983.

<sup>c</sup>J. S. Reis, S. R. Pliska, and E. Hughes. "A Synopsis of Federal-State Sponsored Preventive Child Health," *J. Community Health* 9:222-239, 1964.

SOURCE: Office of Technology Assessment, 1988, based on a background paper by C.J. Homer, "Evaluation of the Evidence on the Effectiveness of Well-Child Care Services for Children," prepared for the Office of Technology Assessment, U S Congress, Washington, DC. April 1987.



**Table J-4.—Effectiveness of Well-Child Care as a Whole: Comparisons of Health Outcomes in Alternative Health Delivery and Insurance Systems**

Author	Years data collected	Study population	Study design	Sample size	Intervention	Outcome measures	Results	Comments
Valdez 1986 <sup>a</sup>	1974-82	R C T	Random sample families from six communities some exclusions 0-11 yr	1 844 children	Differing levels of insurance	Physiologic function anemia, middle ear fluid; hearing loss, visual acuity Physical health limitations in daily activity Mental and general health perception	<ol style="list-style-type: none"> <li>Overall no significant difference in health measures with differing levels of insurance</li> <li>Decreased utilization associated with cost sharing—preventive services decreased by comparable amount to other services</li> <li>For poor children who were anemic at outset of study 8% of those in free care were anemic by the end of the study, compared to 22% of those in cost sharing</li> </ol>	<ol style="list-style-type: none"> <li>Sample attrition 30%</li> <li>Plans not representative of those generally available to the poor</li> <li>Inadequate power for examination of role limitations and for subgroup analyses</li> <li>Growth and developmental outcomes not reported</li> </ol>
Kessner et al 1974 <sup>b</sup>	1970-71	Cross sectional	Washington, DC Random sample from specific neighborhoods, predominantly black, 6 mo-11 yr	1,436 families 2,780 children	Six different types of providers, including both prepaid and fee-for service	'Tracer' conditions— 1. Middle ear infection/hearing loss 2. Iron deficiency anemia 3. Visual disorders	<ol style="list-style-type: none"> <li>Provider type had no significant influence on health status measures after controlling for socioeconomic status</li> <li>Tests often not performed as often as recommended</li> <li>Abnormal results often not followed with treatment</li> </ol>	<ol style="list-style-type: none"> <li>Generalizability limited with 1 city, black population, large numbers of inner-city solo practitioners</li> <li>Question of adequate controlling for socioeconomic status</li> <li>Question regarding aggregation of provider types</li> <li>Implications for preventive care uncertain, if valid, implication is that although prepaid programs provided more preventive care, outcomes no different</li> </ol>
Dutton and Silber, 1980 <sup>c</sup>	1970-71	Reanalyses of Kessner data	Washington DC Random sample from specific neighborhoods predominantly black, 6 mo-11 yr	1,436 families 2,780 children	Different types of providers	'Tracer' conditions— 1. Middle ear infection/hearing loss 2. Iron deficiency anemia 3. Visual disorders	<p>Trend toward lower health status for users of solo practitioners relative to users of prepaid or OPD care</p> <p><b>Lower satisfaction with OPD use</b></p>	<ol style="list-style-type: none"> <li>Question regarding generalizability</li> <li>Aggregate effect very small</li> <li>Question appropriateness of linking OPD and prepaid care schemes</li> </ol>

Abbreviations OPD – outpatient delivery clinic; RCT = randomized clinical trial  
<sup>a</sup> Robert B. Valdez, *The Effects of Cost Sharing on the Health of Children*, R-3270-HHS (Santa Monica, CA Rand Corp., 1986)  
<sup>b</sup> D. M. Kessner, C. K. Snow and J. Singer, *Assessment of Medical Care for Children* (Washington, DC: National Academy of Sciences, 1974)  
<sup>c</sup> C. B. Dutton and R. S. Silber, "Children's Health Outcomes in Six Different Ambulatory Care Delivery Systems," *Medical Care* 18:693-714, 1980

SOURCE: Office of Technology Assessment, 1988, based on a background paper by C. J. Homer, "Evaluation of the Evidence on the Effectiveness of Well-Child Care Services for Children," prepared for the Office of Technology Assessment, U. S. Congress, Washington, DC, April 1987

Table J-5.—Effectiveness of Well-Child Care as a Whole: Studies of the Effects of Well-Child Care on Developmental Outcomes

Author	Years data collected	Study population	Study design	Sample size	Intervention	Outcome measures	Results	Comments
Cullen, 1976 <sup>a</sup>	1964-73	Rural W Australia other criteria not stated	Stratified, men randomized (RCT)	101 families 122 children each group	20-30 minute interview every 3 mo. m 1st yr; then every 6 mo, for 4 yr, emphasis on gentleness, positive outlook	1. Behavior symptoms 2. Family relations 3. Readiness for work 4. Basic learning ability 5. Early school personality 6. Stan-Binet vocab 7. Describe a picture 8. Spontaneous speech 9. Draw a man	Fewer fears, more school lateness, many behaviors with no differences, boys m intervention groups generally became worse m school performance and behavior; no effect for girls	Sample uncertain Generalizability uncertain Intervention not standardized Importance of outcomes unclear Plausibility of sex interaction limited
Gutelius, et al., 1977 <sup>b</sup>	1965-76 (enrolled 1965-69 with 6 year followup)	Urban Washington, DC, primigravid 15-18-year-old mothers with early prenatal care, IQ >70; no neonatal problems	RCT	47 experimental 48 control	Pediatrician and nurse well-child visits in motor coach, 1 hour each; additional nurse visits-total 18/12/8 1st 3 yr, Group counseling, medicinal iron, cognitive stimulation program	Bayley Stanford-Binet WISC-R Behavior profile School readiness	Cognitive: decreasing differences after age 3 Behavioral: improved social and self-confidence scores at age 3, fewer behavior problems age 5 on; improved school completion by expectant mothers as program evolved	Generalizability limited due to nature of study population and intensity of program, outcome assessment not blinded; intervention unstandardized; late attrition in control group of better Performers
Chamberlain and Szumowski, 1980 <sup>c</sup>	1976-79	Rochester, primiparous mother recruited from pediatricians	Cohort	371 total	Various levels and methods of extensive parent education m pediatrician offices (e.g., discussions, handouts, shale presentations)	Maternal knowledge, attitudes, child-rearing style Child behavior, development	Increased knowledge with increased teaching; no effect on development, increased reported behavior problems, small but significant correlation teaching and positive interaction	Middle class population, all providers in one practice given average rating (measurement error); attrition to lower socioeconomic status families, regression technique may have masked study effect by including intervening variable; question selection bias
Casey and Whitt, 1980 <sup>d</sup>	1977-78	North Carolina, primiparous mothers, no medical complications, no identified source of pediatric care	RCT (randomized after stratification)	15 experimental 17 control (of 59 eligible)	Counseling emphasizing affective interaction; control of well-child care by same MD (all intervention by one physician)	8 scales maternal-Infant interaction; Bayley, object permanence and vocal imitation scales	All scales favored intervention; significant differences 4/8 No significant difference Bayley; vocal imitation favored Intervention p<0.1	Short followup; outcome measures of uncertain significance; power limited; generalizability limited by population and perhaps nature of intervention (unique to provider?)

Abbreviations: RCT = randomized clinical trial; WISC-R = Wechsler intelligence scale for children

<sup>a</sup>K. J. Cullen, "A Six-Year Controlled Trial of Prevention of Children's Behavior Disorders," *J. Pediatrics* 88:662-666, 1976

<sup>b</sup>M. F. Gutelius, A. D. Kirsch, S. MacDonald, et al., "Controlled Study of Child Health Supervision" Behavioral Results, " *Pediatrics* 60:294-304, 1977.

<sup>c</sup>R. W. Chamberlain and B.A. Szumowski, "A Followup Study of Parent Education in Pediatric Office Practices: Impact at Age Two and a Half," *Am J. Public Health* 70:1 160-1188, 1980

<sup>d</sup>P. Casey and J. K. Whitt, "Effect of the Pediatrician on the Mother-Infant Relationship," *Pediatrics* 65:81 5-820, 1980

SOURCE: Office of Technology Assessment, 1988, based on a background paper by C.J. Homer, "Evaluation of the Evidence on the Effectiveness of Well-Child Care Services for Children," prepared for the Office of Technology Assessment, U.S. Congress, Washington, DC, April 1987

**Table J-6.—Studies of the Effectiveness of the General Physical Examination in Well-Child Care**

Author	Years data collected	Sample	Method of data collection	Validation	Reliability assessment	Utility assessment	Definition of exam	Yield	Comments
<i>Infant:</i>									
Anderson, 1970 <sup>a</sup>	1969	44% practicing Connecticut pediatricians, 100 consecutive well-child exams	Physician report of abnormality	None	None	None	Physical exam or "routine" lab tests only	11.4% of exams resulted in abnormality, 1.9% in significant abnormality, 80% discovered by 6 mo.	Parents unaware of abnormalities needing prescription 62% of time Study of limited value
<i>Preschool:</i>									
O'Connell and Friesen 1976b	1970	382 born in Mayo clinic, underwent preschool exam and entered KG 1970	Chart review	None	None	None	Preschool exam which included history, physical exam, watch hearing test, and Snellen vision test	31% of exams resulted in previously undetected abnormalities	Biases in sample selection
Welch and Kesler, 1982 <sup>c</sup>	1978	1 158 entering KG Roanoke Virginia 1977	Comparison of school screening program with written physician preschool report	Study in one sense is validation of prior physician exam, screening positive findings "confirmed"	Not clearly specified screeners underwent training	None	School-based screening tests physician's exam included weight, height, vision, hearing blood pressure, and caries	33% of children had abnormalities, 91% of these detected by screening, 30% detected by physician exam	Abnormalities detected by exam and not screened for are not discussed
<i>School aged:</i>									
Yankauer and Lawrence 1955 <sup>d</sup>	1952-53	1,056 1st grade children from representative sample of schools	Examined by 1 MD, vision, hearing, and dental problems not included	Limited—if in doubt a second opinion was sought	None	163 conditions initially identified, 99 still present in grade 4, most new conditions also present grade 4, ENT and emotional problems most likely to improve, emotional problems least likely to be in care	Patient history as well as a physical exam	21% of children had abnormality, 78% under care and 12% more known, If preschool family MD exam, condition more likely under care	Relies on adequacy of care by an outside (family) physician
Yankauer and Lawrence 1956 <sup>e</sup>	1952-56	617 of above remaining for 3 years and 284 remaining 1 or 2 years	Same as Yankauer and Lawrence 1955 <sup>d</sup>	Same as Yankauer and Lawrence, 1955 <sup>d</sup>	None	Same as Yankauer and Lawrence 1955 <sup>d</sup>	Same as Yankauer and Lawrence, 1955 <sup>d</sup>	14% develop new condition, primarily emotional and ENT, 50% under care before school exam	1 /251 exams resulted in a condition diagnosed not already under treatment

**Table J-6.—Studies of the Effectiveness of the General Physical Examination in Well-Child Care-Continued**

Author	Years data collected	Sample	Years		Reliability assessment	Utility assessment	Definition of exam	Yield	Comments
			Method of data collection	Validation					
Yankauer, et al., 1957 <sup>1</sup>	1952-56	617 of above remaining for 3 years and 284 remaining 1 or 2 years	et al., 1957 <sup>1</sup> and Lawrence, 1955d	617 of above remaining for 3 years 1 9 5 5 <sup>d</sup>	None	Same as Yankauer and Lawrence 1955 <sup>1</sup>	Same as Yankauer and Lawrence 1955 <sup>1</sup>	See "Utility assessment"	No examination of "labeling"
Grant, et al., 1973 <sup>9</sup>	1967-70	6,058 students in El Paso schools undergoing annual screening, age 5-18 yr	Paramedic screening tests, physician physical exam, rashes, acute illnesses, emotional problems excluded	None	None	None (authors judged a detected condition worthwhile even if referral resulted in a "diagnosis" of no significance, such as functional murmur)	Not specified	13.4% had abnormality detected—9.5% by screening, 3.9% by exam	37% of all abnormalities were due to inadequate vision
Kohler 1977 <sup>11</sup>	1969-72	649 children age 7 in one town in Sweden	Author examined all students	None	None	None	Physical exam is included growth parameters and urinalysis	15% had abnormality detected, half were vision problems, half previously known physical examination detected functionally important abnormality in 6.5%	None
DeAngelis, et al., 1983 <sup>13</sup>	1980-81	12,997 rural students, little access to medical care, nurse practitioners	Aides administered screening tests Nurse practitioner did physical exam	None	None	None	Not specified	34% of students undergoing physical examination had a problem identified, only 17% previously known	Little overlap in conditions, acute, self-imposed problems included, no utility measure

Abbreviations: ENT = ear, nose, and throat; KG = kindergarten; MU = physician.  
<sup>1</sup>F. P. Anderson, "Evaluation of the Routine Physical Examination of Infants in the First Year of Life," *Pediatrics* 45:950-964, 1970.  
<sup>2</sup>E. J. O'Connell and C. D. Friesen, "The Preschool Physical Examination," *Clinical Pediatrics* 15:930-931, 1976.  
<sup>3</sup>N. M. Welch and R. W. Kester, "The Value of the Preschool Examination in Screening for Health Problems," *J. Pediatrics* 100:232-234, 1982.  
<sup>4</sup>A. Yankauer and R. A. Lawrence, "A Study of Periodic School Medical Examinations—I. Methodology and Initial Findings," *Am. J. Public Health* 45:71-78, 1955.  
<sup>5</sup>A. Yankauer and R. Lawrence, "A Study of Periodic School Medical Examinations—II. The Annual Increment of New 'Defects'," *Am. J. Public Health* 55:1553-1562, 1956.  
<sup>6</sup>A. Yankauer, R. Lawrence, and L. Baltou, "A Study of Periodic School Medical Examinations—III. The Remediability of Certain Categories of 'Defects,'" *Am. J. Public Health* 47:1421-1422, 1957.  
<sup>9</sup>W. W. Grant, R. G. Fearnow, L. M. Hebertson, et al., "Health Screening in School-Age Children," *Am. J. Dis. Child.* 125:520-522, 1973.  
<sup>11</sup>L. Kohler, "Physical Mass Examinations in the School Health Service," *Acta Paediatr. Scand* 66:307-310, 1977.  
<sup>13</sup>C. DeAngelis, B. Berman, D. Oda, et al., "Comparative Values of School Physical Examinations and Mass Screening Tests," *J. Pediatrics* 102:477-481, 1983.

SOURCE: Office of Technology Assessment, 1988, based on a background paper by C. J. Homer, "Evaluation of the Evidence on the Effectiveness of Well-Child Care Services for Children," prepared for the Office of Technology Assessment, U.S. Congress, Washington, DC, April 1987.

**Table J.7.—Studies of the Predictive Validity of the Denver Developmental Screening Test (DDST)**

Author	Years data collected	Sample characteristics	Outcome measures	Prevalence of school failure	Sensitivity	Specificity
Camp, et al 1977 <sup>a</sup>	1969-72	Low-income Denver residents using a Neighborhood Health Center, took DDST. If abnormal, asked back, if normal, some asked back, of these, those over 8 years old before 9/73 and still living in Denver in the public schools were included, 493 initially came back, 92 met age criteria; followup on 65 of 92	Special class or repeat achievement test >1.5 years behind Significant teacher rated behavior problem Diagnosis of hyperactivity IQ below 80	57% with either la below 80 or learning problem	78%	60%
Cadman et al., 1987 <sup>b</sup>	1980-84	All children registering for normal kindergarten in three or four regions of Niagara, Ontario, children randomized to receive DDST with counseling, DDST without counseling, and no DDST, all abnormal and random sample of others underwent further testing	Teacher and parent reported learning problems Child not in regular class Parental worry WRAT WISC-R Child Well Being Questionnaire	9% not in regular 2nd grade class	6%	99%
Sturner, et al., 1985 <sup>c</sup>	1978-80	All children registering for kindergarten in Person County, North Carolina, screened with DDST-S; followup testing on differing proportions of abnormal (100%), questionables (50%), and normals (10%)	Special class or repeat CAT-R < 20th percentile	27% not regular class or < 20th percentile on CAT-R	5% stage 26%-2 stage	87%-1 stage 94%-2 stage

Abbreviations WISC-R = Wechsler intelligence scale for children, WRAT = Wide Range Achievement Test

<sup>a</sup> W Camp, W van Doorninck, W K Frankenburg, et al. "Preschool Developmental Testing in Prediction of School Problems," *Clinical Pediatrics* 16:257-263, 1977.

<sup>b</sup> D Cadman, L W Chambers, S D Walter, et al., "Evaluation of Public Health Preschool Child Developmental Screening: The Process and Outcomes of a Community Program," *Am. J Public Health* 77:45-51, 1987

<sup>c</sup> R A Sturmer, J A Green, and S G Funk, "Preschool Denver Developmental Screening Test as a Predictor of Later School Problems," *J. Pediatrics* 107:615-621, 1985

SOURCE Office of Technology Assessment, 1988, based on a background paper by C.J Homer, "Evaluation of the Evidence on the Effectiveness of Well-Child Care Services for Children," prepared for the Office of Technology Assessment, U.S. Congress, Washington, DC, April 1987

**Table J-8.—Studies of the Effectiveness of Anticipatory Guidance on Child Safety Restraint Use**

Author	Years	Site/practice style	Sample size	Allocation method	Intervention	Outcome assessment	Results	Comments
Bass and Wilson, 1964 <sup>a</sup>	1962-63	Pittsburgh/private practice	1,423	1. Control group = users one practice 2 Different experimental groups = users another practice at different times	1. Letter by MD 2 Letter by MD + counseling 3 Letter by safety organization	Maternal report of seat-belt Installation, by phone	19.6% no Information, 19.1% organization letter, 15.3% MD letter, 43% MD letter + counseling	Concerns regarding biases in allocation and assessment
Kanthor, 1976 <sup>b</sup>	1974-75	Rochester/prepaid health plan	16 experimental 19 control	(Quasi-random (every other infant born))	1 Counseling by MD + pamphlet at prenatal Visit; control = no education	Maternal report, occasionally verified	42% use no Information, 69% information (p=0.21)	Small sample size bias in assessment no significant difference
Allen and Bergman, 1976 <sup>c</sup>	1974-75	Seattle/prepaid health plan	202 of 500 eligible	Volunteers for nonconcurrent intervention groups	1 Informational material only 2 Informational material + film presentation 3. Informational material, film presentation, and rehearsal of car seat use, control = no information (postpartum)	Maternal report- questionnaire	1. 37% no Information 2. 54% Information only 3. 71% Information + film only 4. 60% information + film + rehearsal	Selection bias assessment bias not necessarily relevant to office practice
Scherz, 1976 <sup>d</sup>	1970-74	Tacoma/military well-child care	500	Random allocation	1. No reformation 2. Display 3. Display + pamphlet 4. Display + pamphlet + nurse counseling 5. Display + pamphlet + MD counseling	Maternal report-questionnaire at 8 weeks and 9-12 mo.	At 8 weeks/12 months, % safe = 1) 9/77 2) 12/74 3) 8/75 4) 22/81 5) 13/88	Bias in assessment due to military population
Miller and Pless, 1977 <sup>e</sup>	1975-76	Rochester/pediatric group practice	654 (age 0-17)	Randomized	1 Pamphlet + verbal information 2. Pamphlet + verbal + slide/tape, control = no education	Maternal questionnaire, rough validation with direct observation	No significant differences between control m either intervention group	Power not a "physician" intervention per se
Reisinger and Williams, 1978 <sup>f</sup>	1976-77	Pittsburgh/in-hospital program	1,107	Consecutive time intervals (nonconcurrent controls)	Control = no education 1 Literature only 2 Literature + health educator 3. Literature + free car seat	Direct observation at hospital discharge and 2 mo. followup	Very low use at time of hospital discharge, no study effect, gradient from control to free seat with use at 2 mo., i.e., 26%/31%/36%/41 %. Only free group had statistically significant difference from control	Rates may be inflated compared to general population m that more educated parents are both more likely to use seat belts and to come for followup
Reosomger, et al, 1981 <sup>g</sup>	1978-79	Pittsburgh/private practice	269	Nonconcurrent intervention and control periods	Control = no information Study = education by pediatrician with discussion, pamphlet, and demonstration	Direct observation at 1, 2, 4, 9, 15 mo.	Significant difference at 2 mo. (50 v 29%); no difference from 4 mo. thereafter	Attrition ranged from 10-23%

Abbreviation: MD = pediatrician.  
<sup>a</sup>L.W. Bass and T.R. Wilson, "The pediatrician's Influence in private practice Measured by a Controlled Seat Belt Study," *Pediatrics* 33:700-704, 1964.  
<sup>b</sup>H.A. Kanthor, "Car Safety for Infants: Effectiveness of Prenatal Counseling," *Pediatrics* 58:320-322, 1976.  
<sup>c</sup>D.B. Allen and A.B. Bergman, "Social Learning Approaches to Health Education: Utilization of Infant Auto Restraint Devices," *Pediatrics* 58:323-328, 1976.  
<sup>d</sup>R.G. Scherz, "Restraint Systems for the prevention of Injury to Children in Automobile Accidents," *Am. J. Public Health* 66:451-456, 1976.  
<sup>e</sup>J.R. Miller and I.B. Pless, "Child Automobile Restraints Evaluation of Health Education," *Pediatrics* 59:907-911, 1977.  
<sup>f</sup>K.S. Reisinger and A.F. Williams, "Evaluation of Programs Designed To Increase the Protection of Infants in Cars," *Pediatrics* 62:260-287, 1978.  
<sup>g</sup>K.S. Reisinger, A.F. Williams, J.K. Wells, et al, "Effects of Pediatricians' Counseling on Infant Restraint Use," *Pediatrics* 67:201-206, 1981.

SOURCE: Office of Technology Assessment, 1968, based on a background paper by C.J. Homer, "Evaluation of the Evidence on the Effectiveness of Well-Child Care Services for Children," prepared for the Office of Technology Assessment, U.S. Congress, Washington, DC, April 1987.

**Table J-9.—Recent Economic Evaluations of Childhood Vaccination Programs<sup>a</sup>**

Author	Type of vaccine	Alternative compared	Population studied	Costs and benefits considered	Findings	Critical assumptions	Comments
Cochi, et al 1985 <sup>b</sup>	Hib	1 Hib vaccination at 18 mo. v. no vaccination	U S population 1-2 yrs old	Direct medical costs and benefits	Net benefit in direct short- and long-term savings = \$307 million	Cost of vaccine = \$3/dose No additional administrative cost because in conjunction with 18-mo DTP visit 80% coverage 75% efficacy	Sensitivity analysis performed for alternative strategies, varied efficacy, coverage incidence and cost of vaccine, no discounting of acute case costs saved Long-term costs discounted at 5%
		2 Hib vaccination at 24 mo. v no vaccination			Net benefit in direct short- and long-term savings = \$11 million		
Hay and Daum, 1987 <sup>b</sup>	Hib	Hib vaccine at 24 mo v. no vaccination	1984 U S birth cohort (from 0-5 yr)	Direct and Indirect costs and benefits including an economic valuation of life	Net savings of \$648 million	60% vaccine coverage Vaccine cost = \$8.13/dose Office visit cost = \$20 70% efficacy	Many other strategies were considered as well, including rifampin prophylaxis, sensitivity analysis was performed
White, et al 1985 <sup>c</sup>	MMR	MMR vaccination v single antigen vaccination v no vaccination	U S population (examined actual 1983 data)	Direct and Indirect costs and benefits	Combined vaccine (MMR) benefit-cost ratio = 1.341 Single antigen vaccine benefit-cost ratios measles = 11.91 rubella = 7.71 mumps = 6.71 Savings due to use of combined rather than single antigen vaccine = \$60 million	Vaccine costs office visit = \$15.00 measles = \$4.26 rubella = \$4.76 mumps = \$5.57 MMR = \$11.30 Discount rate = 10%	Based on actual and estimated data for 1983
Bloch, et al , 1985 <sup>d</sup>	Measles	Measles vaccination program, 1963-82 v no vaccination program, 1963-82	U S population	Direct and indirect costs and benefits	Net savings for the 20-year period (1963-82) = \$51 billion	Unspecified	Comprehensive review of benefits due to measles vaccination from 1963-82, based on previously published studies
Preblud, et al , 1985 <sup>e</sup>	Varicella (chickenpox)	Varicella vaccination in conjunction with MMR (1 dose at 15 mo. ) v no vaccination	Hypothetical birth cohort of 3.5 million (a size approximating that of the U S ) normal individuals followed from birth to their 30th birthday	Direct medical and home care costs (those associated with lost work time by someone other than the patient)	Overall benefit-cost ratio = 6.91 Net savings of \$262 million	No administration cost because administered in conjunction with MMR Coverage = 90% Efficacy = 90% No herd immunity Discount rate = 5%	Sensitivity analysis performed for best- and worst-case scenarios Home care costs accounted for 95% of the disease-related costs

**Table J-9.— Recent Economic Evaluations of Childhood Vaccination Programs<sup>a</sup>—Continued**

Author	Type of vaccine	Alternate compared	Population studied	Costs and benefits considered	Findings	Critical assumptions	Comments
Hinman and Koplan, 1984 <sup>1</sup>	Pertussis	Pertussis vaccination in conjunction with DT vaccines (5 doses, 0-6 yr) v no vaccination (DT vaccine only)	Hypothetical cohort of 1 million children, based on U.K. incidence rates (because less underreporting than U.S.) and extrapolated to U.S. population	Direct medical costs and benefits	The benefit-cost ratio (reduction in disease costs divided by program costs) is 11:1	<b>90% coverage (5 doses)</b> <b>80% efficacy</b> <b>Vaccine cost=\$0.03/dose</b> <b>No administrative cost because administered in conjunction with DT</b> <b>Discount rate = 5%</b>	Sensitivity analysis performed for the following: 1 assuming no herd immunity 2 assuming all children with convulsion, collapse, or high-pitched cry following vaccination seek medical care
White and Axnick, 1975 <sup>2</sup>	Measles	<b>Measles vaccination as implemented 1963-72 v no measles vaccine</b>	U.S. population	Direct and redirect benefits and costs	Net benefit achieved through immunization was \$1.3 billion over 10-yr period	Costs of production, distribution, administration, and promotion of vaccine is \$3.00/dose	Basis for monetary estimate of direct and indirect benefits not given Costs and benefits not discounted
Axnick, et al 1969 <sup>3</sup>	Measles	Measles vaccination as implemented 1963-68 v. no vaccination	U.S. population	Direct and indirect costs and benefits due to vaccination	National net direct benefits \$200 million, net direct and indirect benefits in period 1963-68 were \$531 million	<b>Physician office visit cost= \$73/day for measles encephalitis;</b> <b>= \$40/day for hospitalized measles cases</b>	Some benefits and costs not discounted Direct costs for each year estimated in current dollars
Ambrosch and Wiedermann, 1979 <sup>4</sup>	Measles and mumps	Measles and mumps vaccination of 1-yr-olds v no vaccination	Austrian population	Direct costs of immunization and therapy and indirect costs of lost work time for mothers	Over a 12-yr period of vaccinations, net direct benefits are positive (at 1681/90 Austrian Shillings per child)	<b>Vaccine acceptance is 100%; 20% of mothers are employed; 5 days mothers' work time lost for measles and mumps</b>	Costs not discounted over time
Massachusetts Department of Health, 1980 <sup>5</sup>	MMR	MMR vaccination program run by State v. no program	Massachusetts population	Direct costs of vaccinations and medical care associated with the disease	Cumulative effect of MMR program since 1966 has saved the State \$14.1 million	Unknown, not well described	Basis for monetary estimates not given; costs over time not discounted
Ekblom, et al, 1978 <sup>6</sup>	Measles	Measles vaccination of all 1-yr-olds v. no vaccination	Population of Finland	Cumulative discounted net direct and indirect benefits 1975-99	Total benefits outweigh total costs by third year of study, ratio of net benefit to cost is 3:1-4:1	Discount rate = 9%	Basis for monetary estimates not given
Koplan and Preblud, 1982 <sup>7</sup>	Mumps	Mumps vaccine in conjunction with measles and rubella v. measles and rubella vaccine only	U.S. population	Direct and Indirect costs and benefits	<b>Vaccination saves approximately \$5.4 million per million vaccines</b>	Discount rate = 5% Cost of mumps vaccination = \$100	Vaccination program is that recommended by American Academy of Pediatrics (vaccinations of 1-yr-olds)



Schoenbaum, et al 1976 <sup>p</sup>	Rubella	Rubella vaccination of 2-yr-old children as part of measles and mumps vaccine v vaccination of 6-yr-old children with monovalent vaccine v vaccination of 12-yr-old females with monovalent vaccine	U S population	Direct costs of vaccination v direct and indirect costs of congenital rubella syndrome	Ratio of benefit to cost is 25:1 for 12-yr-old girls, 91 for 6-yr-old children, and 231 for 2-yr-old children	Compliance for all ages is 80% No 12-yr-old girls would be pregnant at time of vaccination	Compliance in infants is likely to be higher than Compliance in 12-yr-olds Herd Immunity not considered
Farber and Finkelstein, 1979 <sup>p</sup>	Rubella	Premarital testing for rubella antibodies in area with a childhood MMR vaccination program v childhood rubella vaccination only	U S population	Net direct and indirect costs and benefits	Testing program would not have positive net benefits unless compliance with vaccination is at least 37% and test cost less than \$55	Without testing program, incidence of congenital rubella syndrome would be same as current experience	Sensitivity analysis performed for different assumptions about under reporting of rubella incidence
Koplan, et al, 1979 <sup>p</sup>	Pertussis	Pertussis vaccination in conjunction with diphtheria and tetanus (DTP) vaccines v. DT vaccine only	U S infant population	Direct medical costs per pertussis case prevented and life saved	Net direct costs of medical care are negative (i.e. pertussis vaccine is cost-saving); pertussis vaccine saves 56 deaths per 1 million vaccines	90% Immunization coverage (acceptance); 70% vaccine efficacy; serious vaccine complications: convulsions, 1 m 3,500, encephalitis, 1 m 50,000; case fatality from these complications same as for pertussis	Vaccination program is that recommended by American Academy of Pediatrics Vaccine administration costs are minimal because pertussis can be combined with DT inoculations

Abbreviations DT = diphtheria, tetanus Hib = *Haemophilus influenzae* type b; MMR = measles, mumps, and rubella  
 aS, L. Cochi, C v Broome, and A.W. Hightower, "Immunization of U.S. Children With *Haemophilus Influenzae* Type b Polysaccharide Vaccine A Cost-Effectiveness Model of Strategy Assessment," *JAMA* 253(4):521-529, 1985.  
 bJ.W. Hay and R.S. Daum, "Cost-Benefit Analysis of Two Strategies for Prevention of *Haemophilus Influenzae* Type b Infection," *Pediatrics* 80(3):319-330, 1987.  
 cC. White, J.P. Koplan, and W.A. Orenstein, "Benefits, Risks and Costs of Immunization for Measles, Mumps and Rubella," *Am J. Public Health* 75(7):739-744, 1985  
 dA.B. Bloch, W.A. Orenstein, H.C. Stetler, et al., "Health Impact of Measles Vaccination in the United States," *Pediatrics* 76(4):524-532, 1985.  
 eS.P. Preblud, W.A. Orenstein, J.P. Koplan, et al., "A Benefit-Cost Analysis of a Childhood Varicella Vaccination Programmed," *Postgraduate Medical J* 61(suppl. 4) "17-22, 1985  
 fA.R. Hinman and J.P. Koplan, "Pertussis and Pertussis Vaccine: Reanalysis of Benefits, Risks, and Costs," *JAMA* 251(23):3109-3113, 1984  
 gJ. Witte and N. Axnick, "The Benefits From 10 Years of Measles Immunization in the United States," *Public Health Reports* 90(3):205-207, May-June 1975  
 hN. Axnick, S. Shaven, and J. Witte, "Benefits Due to Immunization Against Measles," *Public Health Reports* 84(8):673-680, August 1969  
 iF. Am brosch, and G. Wiederman, "Costs and Benefits of Measles and Mumps Immunization in Austria," *Bull. WHO* 57(4):625-629, 1979.  
 jMassachusetts Department of Health, "Report on the Measles, Mumps, and Rubella Immunization Programs," Boston, MA, March 1980  
 kM. Fekblom, O. Eio, and P. Niemela, "Costs and Benefits of Measles Vaccination in Finland," *Scandinavian J. Soc. Med.* 6(3):111-115, 1978.  
 lJ.P. Koplan and S.R. Preblud, "A Benefit-Cost Analysis of Mumps Vaccine," *Am. J. Dis. Child.* 136:362-364, April 1982  
 mS.C. Schoenbaum, J.N. Hyde, Jr., L. Bartoshevsky, et al., "Benefit-Cost Analysis of Rubella Vaccination Policy," *N. Eng. J. Med* 294(6) 306-310, 1976.  
 nM. Farber and S. Finkelstein, "A Cost-Benefit Analysis of a Mandatory Premarital Rubella-Antibody Screening Program," *N. Eng. J. Med* 300(15):856-859, 1979  
 oJ.P. Koplan, S.C. Schoenbaum, M.C. Weinstein, et al., "Pertussis Vaccine: An Analysis of Benefits, Risks and Costs," *N. Eng. J. Med* 301(17):906-911, 1979  
 pBased on J.L. Wagner, "The Economic Evaluation of Medicines: A Review of the Literature," prepared for the Pharmaceutical Manufacturers' Association, Washington, DC, August 1982  
 qThe Weisbrod study of the net benefits of medical research on poliomyelitis (B.A. Weisbrod, "Costs and Benefits of Medical Research: A Case Study of Poliomyelitis," *J. Political Economy* 79(3):527-544, 1971) was not included because it does not address immunization policy per se  
 rThe term "direct costs and benefits" refers to medical costs incurred or averted. The term "indirect costs or benefits" refers to the economic value of lost productivity incurred or averted

SOURCE Office of Technology Assessment, 1988, adapted in part from J.L. Wagner, "The Economic Evaluation of Medicines A Review of the Literature," prepared for the Pharmaceutical Manufacturers' Association, Washington, DC, August 1982

# Current National Data Sources on Accidental Injuries

---

As noted in chapter 7, there are five major national sources of accidental injury data:

1. death certificates,
2. hospital discharge abstracts,
3. hospital emergency room reports,
4. national health survey data, and
5. traffic accident data.

These sources, along with their advantages and disadvantages are described briefly below.

## Death Certificates

Death certificates include information on the cause of death and thus can yield injury fatality statistics. Because States are required to report all deaths to the Centers for Disease Control, this system presumably includes all accidental deaths in the United States. Fatality statistics are compiled and published by the National Center for Health Statistics (NCHS).

Accident fatality statistics have four major drawbacks. First, such statistics obviously include only deaths; since most specific types of accidental injury lead to only a few childhood deaths, changes in fatality statistics are generally useful for monitoring only large-scale, national changes in accident fatalities. Second, accident fatality statistics may overstate accidental injury fatalities if *some* nonaccidental injuries (e.g., child abuse, suicide) are incorrectly reported as accidental (e.g., fall down stairs, accidental gun wound). Or conversely, fatality statistics may understate accidental deaths if there is incomplete reporting of all deaths. Third, these statistics are not detailed enough to be useful in analyzing accident fatality trends in great detail, because the fatalities are summarized according to the injury groupings of the International Classification of Diseases (see below). Fourth, the compilation of national fatality statistics is time-consuming; thus, for example, the most recent statistics available in 1987 are from 1984. Despite their drawbacks, however, accident fatality statistics are a very useful way of monitoring overall national progress in accident prevention.

## Hospital Discharge Abstracts

Hospital discharge abstracts summarize essential information on patients admitted to the hospital, including numerical codes representing patient diagnoses,

Various organizations, such as the American Hospital Association and NCHS, use these abstracts to compile health statistics.

The available diagnostic codes, listed in the International Classification of Diseases, include a special subset of codes for the cause of an injury. The codes in this subset are prefixed by the letter "E". Thus, the inclusion of the appropriate "E" code, when applicable, on discharge abstracts could lead to a very large national database of information on injuries serious enough to cause hospitalization. Such a database could also be used as a basis for in-depth studies of certain geographical areas, injury costs, or trends in serious injury.

Unfortunately, few hospitals routinely include "E" codes on their discharge summaries (the information sheets used as the basis for the discharge abstracts). Health officials in Massachusetts report that in that State, only about one-half of hospitals include the codes (189). Furthermore, the abstracting services commonly used by hospitals often drop these codes on the final abstract even when the codes are included on the summaries, because there is room on the form for only a limited number of codes and the "E" codes have no effect on hospital reimbursement for patient care. Consequently, only about one-fourth of hospital discharge abstracts include information on the cause of injury when applicable. And, even when the "E" code is included, it may be inaccurate or insufficiently specific where the codes themselves are ambiguous or include large categories of injuries. As a result, hospital discharge abstracts offer great potential for extensive injury information but are not useful as they now exist except where special provisions are made in local studies to change these practices.

## Hospital Emergency Room Reports

The Consumer Product Safety Commission (CPSC) operates the National Electronic Injury Surveillance System (NEISS), under which a sample of 62 hospital emergency rooms across the country report detailed information regarding injuries associated with products under CPSC's jurisdiction (414). Rather than reporting "E" codes that designate causes of injuries, participating hospitals report codes for particular products (e. g., bicycles). NEISS provides timely data on accidental injuries and is capable of detecting national

trends (e.g., the increase in the number of injuries associated with all-terrain vehicles) in time for direct action. The data supplied by participating hospitals, by providing the information necessary for followup telephone interviews and hospital records review, also serve as a basis for more in-depth studies of possible issues. A major benefit is that all relevant injuries treated in emergency rooms—not just the very serious injuries resulting in hospitalization or death—are reported.

NEISS has three major drawbacks. First, the system is very expensive to maintain (414). Second, it does not include all accidental injuries (e. g., CPSC has no jurisdiction over firearms or motor vehicles, so injuries associated with these products are not reported). Third, the small hospital sample does not enable CPSC to estimate national injury rates associated with particular products when the number of injuries is relatively small; nor is the sample useful for detecting regional differences in injury rates or for following regional trends.

### National Health Interview Survey

The National Health Interview Survey (NHIS), conducted annually on approximately **40,000 households (including about 30,000 children)**, includes questions on days of limited activity for health reasons and on hospital and physician use. From time to time, additional information is collected on medical care costs or on specific child health issues. As currently formulated, only very general information regarding injuries (e. g., the number of limited activity days of children due to injuries) is regularly collected by the survey. There is currently an effort underway to design the next Child Health Supplement to NHIS (scheduled for 1988) to include some additional, more specific questions on accidental injuries (564).

Unlike other national data sources, NHIS collects background information that can be used to help

correlate injury risk with social, economic, environmental, and behavioral factors. When combined with more specific information on injuries from the survey, this information might help in formulating preventive strategies and targeting them to populations at the greatest risk of accidental injuries.

### Traffic Accident Data

The National Highway Traffic Safety Administration (NHTSA) compiles traffic accident data from two sources. The first is the Fatal Accident Reporting System (FARS), under which all **50 States** provide comprehensive data to NHTSA on all fatal motor vehicle accidents that occur on trafficways (261). FARS reports are based primarily on police reports. Data include geographic details, roadway and other conditions, information on the driver of the vehicle(s) (e.g., prior driving offenses, intoxication), and information on both fatally and nonfatally injured victims (including pedestrians and other persons involved). This database yields extensive information on the circumstances surrounding fatalities; its main drawback, of course, is that only fatal accidents on trafficways (e. g., not driveway fatalities) are included. Data on injured victims are not extensive.

The second database maintained by NHTSA is the National Accident Sampling System. Unlike FARS, this system includes many motor vehicle accidents reported to the police but not involving a fatality. It is based on a statistical sample of 15,000 accidents per year. Data from police reports, collected by a sample survey team, are supplemented with hospital records and, sometimes, by observations of the involved vehicles (261). Advantages of this database are broader representation of traffic accidents and more extensive injury and hospital data; disadvantages are the limits of the sample size and the fact that the database includes only traffic accidents.

## Appendix L

# Preventing Unintended Pregnancies in High-Risk Women: School-Based Clinics

One approach to altering the rate of infant mortality and low birthweight would be to give women at high risk of poor birth outcomes enhanced opportunities to avoid unintended pregnancies (296). It is well known that certain demographically defined groups of women have much higher rates of low birthweight and neonatal mortality than do others, although the exact causes of demographic differences in outcomes are not well understood.

Table L-1 displays national statistics on neonatal mortality rates and low birthweight birth rates by selected maternal demographic characteristics. Because of the close relationship between low birthweight and neonatal mortality, many of the risk factors associated with low birthweight are also predictors of neonatal mortality. Mothers in their twenties and low thirties have the lowest neonatal mortality rates and the lowest percentage of low birthweight births. In comparison to these women, teenagers and women age 35 and above are at higher risk of having babies that die in the neonatal period (the first 28 days of life) and that weigh 2,500 grams (5 lbs. 8 oz.) or less at birth. Education level is included in table L-1 as a proxy for income or socioeconomic status. Women who have not graduated from high school are at greater risk of experiencing poor birth outcomes than women with at least a high school education.

The demographic characteristics found to be related to elevated risk of low birthweight tend to cluster in individual women, but the literature does not specify how the presence of more than one risk factor in an individual woman affects her total risk for poor birth outcomes. Nevertheless, it would appear from table L-1 that providing opportunities for pregnancy prevention to unmarried teens, particularly to those in poverty, would target a group at especially high risk of low birthweight and neonatal mortality.

In 1981, an estimated 24 percent of 20-year-old women in the United States had experienced a first pregnancy before the age of 18 (443). In 1984, about 1,005,000 pregnancies occurred to adolescents, but approximately 40 percent of those ended in abortion and 13 percent in miscarriage (443). Thus, in 1984, the United States experienced about 470,000 births to teenage mothers (443). The vast majority of teenage pregnancies are not only unintended, but unwanted once they occur. In 1979, 82 percent of unmarried teenagers who became pregnant reported that the pregnancy was

**Table L-1.—Relationship Between Selected Maternal Characteristics and Poor Birth Outcomes**

Maternal characteristics	Neonatal mortality rate (1980) <sup>a</sup>	Low birthweight rate (1984) <sup>b</sup>
<b>Age:</b>		
<15 . . . . .	21.9	13.6
15-19 . . . . .	9.6	9.3
20-24 . . . . .	7.1	6.9
25-29 . . . . .	6.5	5.9
30-34 . . . . .	6.7	5.9
35-39 . . . . .	8.1	6.7
40-44 . . . . .	10.6	8.3
45-49 . . . . .	17.4	9.8
<b>Race:</b>		
White . . . . .	6.3	5.6
Black . . . . .	12.3	12.4
<b>Education level:</b>		
0-8 yr . . . . .	10.4	9.4
9-11 yr . . . . .	9.8	10.2
12 yr . . . . .	7.4	6.8
13-15 yr . . . . .	6.3	5.6
> 16 yr . . . . .	5.6	4.5
<b>Marital status:</b>		
Married . . . . .	8.6	5.6
Not married . . . . .	15.6	11.0
<b>Number of previous births:</b>		
0 . . . . .	7.8	
1 . . . . .	6.4	
2 . . . . .	6.7	NA <sup>c</sup>
3 . . . . .	7.1	
4 . . . . .	8.8	
5-15 . . . . .	9.1	

<sup>a</sup>Deaths in the first 28 days of life per 1,000 live singleton births, 1980

<sup>b</sup>Percentage of live births with birthweight of 2,500 grams (about 5 lbs 8 oz.) or less

<sup>c</sup>NA = not available

SOURCES: Neonatal mortality rates Preliminary tables from the National Infant Mortality Surveillance Project, Centers for Disease Control, Public Health Service, U.S. Department of Health and Human Services, Atlanta, GA, May 1986; 1. Eberstein, R. Weller, and D White, Florida State University, Gainesville, FL, unpublished data from the 1980 National Natality Survey, prepared for the Office of Technology Assessment, U.S. Congress, Washington, DC, 1966. Percentage of low birthweight births U.S. Department of Health and Human Services, Public Health Service, National Center for Health Statistics, unpublished data in preparation for *Vital Statistics of the United States* 1984, Vol. 1: Natality, Hyattsville, MD, 1986

unwanted, but of those who did not want the pregnancy, only 32 percent used contraception (443).

Strategies for preventing teen pregnancy span a wide range of philosophies, from programs that are intended to influence teens' attitudes about sexual behavior and relationships to those that prescribe or dispense contraceptive services (443,652a). Two recent excellent re-

views of the evidence on the effectiveness of programs addressing teen pregnancy have concluded that the quality of the evidence on what programs work is poor, owing largely to the difficulty of measuring pregnancy rates among teens, vague program objectives that go beyond pregnancy prevention as a primary goal, and poorly conceived evaluation plans (443, 652a). Despite these problems, there is accumulating tentative evidence that comprehensive school-based clinics that offer contraceptive services (as well as other kinds of health care) can influence teenage pregnancy rates and avoid unwanted births.

Teenagers have special needs when it comes to family planning services. The usefulness of the existing network of family planning agencies is limited by factors that include the need for confidentiality, a caring attitude on the part of staff, and proximity (515a). School-based clinics are clinics in or near junior or senior high schools that typically offer a variety of health care services, including physical examinations, treatment for minor acute illness, preventive services, family planning, pregnancy testing, prenatal care, and screening for venereal disease. Services offered vary widely among programs, and none of the school-based programs consider adolescent family planning to be their sole purpose. The early experience of a program in Minnesota made it clear that school-based clinics limited to reproductive health care alone would be unacceptable to students, largely for reasons of confidentiality (142). At present, while many school-based clinics will refer students to other providers for prescription contraceptives when appropriate, only a minority will prescribe such methods, and only a few actually dispense contraceptives at the clinic site.

The number of school-based health clinics has increased dramatically in the past 3 years. In March 1987, there were 85 clinics affiliated with junior high or high schools throughout the country, up from 61 such clinics in the summer of 1986 (385,385a). Such clinics are usually staffed by nurse practitioners, clinic aides, part-time physicians, social workers, nutritionists, and other professionals.

The effectiveness of school-based clinics in preventing pregnancies and births among adolescents has been examined in three studies to date. Two of the studies assessed a school-based clinic program with three sites in St. Paul, Minnesota (147,333). The third study evaluated a school-based clinic program in Baltimore, Maryland (777).

The two studies of the Minnesota school-based clinic program suggested that the program was successful in reducing birth rates among female students (147,333). From 1976 to 1983, birth rates to female students declined by 50 percent—from 60 births per 1,000 students

in 1976-77, to 46 per 1,000 in 1978-79 (147), to 30 per 1,000 in 1982-83 (333). Contraception continuation rates were quite high (approximately 90 percent) in the population served by the school-based clinics—much higher than the continuation rates observed among adolescent users of regular family planning clinics.<sup>1</sup>

The studies of the Minnesota school-based clinic program have methodological limitations. Clinic staff very probably did not know of all relevant pregnancies and births during the study periods. Pregnancies, births, abortions, and miscarriages occurring to clinic attenders who dropped out of school and clinic non-users may have been missed. Nevertheless, the overall reductions in births observed over the period from 1976 to 1983 are quite large, indicating that even with some overestimation of effectiveness, the Minnesota school-based clinic program had a substantial impact on births among students.

In the 1986 study of a school-based clinic program in Baltimore, the investigators collected data on students from four schools (777). Most of the students were black, inner-city adolescents from families with low socioeconomic status. Students from three schools who received services from an adolescent health center located within three blocks of their schools formed an experimental group. Students from two other schools not served by the clinic were used as a comparison group.<sup>2</sup>

This study showed major impacts of the Baltimore school-based clinic program in preventing pregnancies among students receiving services. Pregnancies among students receiving services from the adolescent health center increased 13 percent after 16 months of exposure, while pregnancies among comparison group students who were not receiving such services increased 50 percent.

More importantly, after 20 months of exposure, pregnancy rates among students receiving clinic services dropped by 22.5 percent, but rose by 39.5 percent among students not receiving clinic services. At 28 months, pregnancies were down by 30 percent among students receiving clinic services and up by 58 percent among students in the comparison schools. In addition, the proportion of students who were sexually active declined in the program school over the course of the study.

Although it is premature to draw conclusions about the effectiveness of school-based clinics in reducing

<sup>1</sup>Fewer than two-thirds of adolescent family planning clinic patients consistently use effective methods of contraception during periods of sexual activity. (269a)

<sup>2</sup>The student bodies of the comparison schools were racially mixed, but of similar socioeconomic status. The analysis was based only on black students in the comparison schools.

high-risk unwanted pregnancies, the evidence accumulated to date does look promising. A large evaluation of school-based clinics is currently underway at the Center for Population Options (333a). The results of that evaluation should offer more information not only on how well such clinics work as a whole, but also on the effectiveness of specific components of a program—such as whether or not the clinic dispenses or prescribes contraceptives—in altering teenage pregnancy.

The costs of providing school-based health services is about \$125 per year per student (443). **School-based clinics** currently receive about two-thirds (**64 percent**)

of their funds from public sources and one-third (**36 percent**) from private sources. The majority of public funds for school-based clinics comes from State sources, through the Maternal and Child Health block grant or State-only funds (333a). Medicaid's Early and Periodic Screening, Diagnosis, and Treatment program provides about 14 percent of the funds for school-based clinics; and other Federal programs, such as Title X (Family Planning), Title XX (Social Services block grant), and the community health centers program provide about 6 percent of the funds (333a).

# Glossary of Abbreviations and Terms

## Glossary of Abbreviations

AAFP	—American Academy of Family Physicians	HMO	—health maintenance organization
AAP	—American Academy of Pediatrics	ICHP	—Improved Child Health Project
AAPC	—American Association for Protecting Children	IHS	—Indian Health Service
ACIP	—Immunization Practices Advisory Committee (PHS)	IOM	—Institute of Medicine
ACOG	—American College of Obstetricians and Gynecologists	IPO	—Improved Pregnancy Outcome (project)
AFDC	—Aid to Families With Dependent Children	MCH	—Maternal and Child Health services (block grant)
BD	—biotinidase deficiency	MHC	—migrant health center
CAH	—congenital adrenal hyperplasia	MIC	—Maternity and Infant Care (project)
CDC	—Centers for Disease Control (PHS)	MMR	—measles, 'mumps, and rubella (vaccine)
CEA	—cost-effectiveness analysis	MSUD	—maple syrup urine disease
CF	—cystic fibrosis	NACHRI	—National Association of Children's Hospitals and Related Institutions
CFR	—Code of Federal Regulations	NCCAN	—National Center on Child Abuse and Neglect (DHHS)
CH	—congenital hypothyroidism	NCHS	—National Center for Health Statistics (PHS)
CHAMPUS	—Civilian Health and Medical Program of the Uniformed Services	NEISS	—National Electronic Injury Surveillance System
CHC	—community health center	NHIS	—National Health Interview Survey
COBRA	—Consolidated Omnibus Budget Reconciliation Act of 1985 (Public Law 99-272)	NHTSA	—National Highway Traffic Safety Administration (U.S. Department of Transportation)
CPS	—Current Population Survey	NICHD	—National Institute for Child Health and Human Development (PHS)
CPSC	—Consumer Product Safety Commission	NICU	—neonatal intensive care unit
DDST	—Denver Developmental Screening Test	NIH	—National Institutes of Health
DES	—diethylstilbestrol	NIMS	—National Infant Mortality Survey
DHHS	—U.S. Department of Health and Human Services	NMCUES	—National Medical Care Utilization and Expenditure Survey
DTP	—diphtheria, tetanus, and pertussis (vaccine)	OB/GYN	—obstetrician /gynecologist
EPSDT	—Early and Periodic Screening, Diagnosis, and Treatment (program) (Medicaid)	OBRA-81	—Omnibus Budget Reconciliation Act of 1981 (Public Law 97-35)
FARS	—Fatal Accident Reporting System	OBRA-86	—Omnibus Budget Reconciliation Act of 1986 (Public Law 99-509)
FEP	—free erythrocyte protoporphyrin	OBRA-87	—Omnibus Budget Reconciliation Act of 1987 (Public Law 100-203)
FR	—Federal Register	OPV	—oral polio vaccine
GAO	—General Accounting Office (U.S. Congress)	OTA	—Office of Technology Assessment (U.S. Congress)
HC	—homocystinuria	PHHS	—Preventive Health and Health Services (block grant)
HCFA	—Health Care Financing Administration (DHHS)	PHS	—Public Health Service (DHHS)
Hgb	—hemoglobin	PKU	—phenylketonuria
Hib	— <i>Haemophilus influenzae b</i>	QALY	—quality-adjusted life year
HIP	—Health Insurance Plan of New York	RCOG	—Royal College of Obstetricians and Gynecologists
		RCT	—randomized clinical trial

RDS	—respiratory distress syndrome
SCA	—sickle cell anemia
SIDS	—sudden infant death syndrome
SMSA	—Standard Metropolitan Statistical Area
SPRANS	—Special Projects of Regional and National Significance
SSI	—Supplemental Security Income
TIPP	—The Injury Prevention Program (AAP)
WIC	—Women, Infants, and Children (program)

## Glossary of Terms

**Abortion rate:** The number of induced abortions per 1,000 live births.

**Accidental injury:** Any injury that is not self-inflicted or caused by maltreatment.

**Acute illness:** An illness characterized by a single episode of fairly short duration, usually less than **30 days**, and from which the patient can be expected to return to his or her normal or previous state and level of activity. Compare *chronic illness*.

**Adverse selection bias** in prenatal care studies: A bias that results from the tendency of women who experience a problem with their pregnancy or who have information that leads them to expect problems (e.g., a poor pregnancy history) to seek care early and often. These women are likely to be at higher than average risk of poor outcomes. Compare *favorable selection bias in prenatal care studies*.

**Aid to Families With Dependent Children (AFDC)** program: A program, established by the Social Security Act of 1935, providing cash payments to needy children (and their caretakers) who lack support because at least one parent is dead, disabled, continually absent from the home, or (in some States) unemployed.

**Ambulatory medical care:** Medical care services that are provided to patients who do not require admission to the hospital as inpatients. Such services may be provided by a private physician or group practice, a public clinic, or a hospital outpatient department.

**Ambulatory tocodynamometry:** A technique that allows noninvasive ambulatory monitoring of uterine contractions in women at risk for premature labor and may enhance the effectiveness of the available therapies to reduce the incidence of premature birth.

**Anemia:** A condition that exists when the level of hemoglobin in a person's blood drops to an abnormally low level (e. g., below 11 grams per deciliter

of whole blood).

**Antenatal care:** Same as *prenatal care*.

**Anticipatory guidance:** The provision of health education, information, or counseling in order to influence the parents' or child's behavior and thus favorably influence the child's health.

**Augmented prenatal care services:** Prenatal care that includes supplemental services such as outreach, transportation, home visitation, nutrition and social services, health education, followup of missed appointments, case management/coordination of services, and dental care.

**Biotinidase deficiency (BD):** A congenital disorder caused by a deficiency of the enzyme needed to metabolize the B vitamin biotin leading to an overall deficiency of biotin in the body. If untreated, severe cases of biotinidase deficiency can lead to neurologic damage, resulting in coma or death in infancy. Less severe cases (resulting in developmental delay and hearing loss) and asymptomatic cases also occur.

**Birth rate:** The number of live births per 1,000 total population.

**Birthweight:** The weight of an infant at the time of delivery. *Normal birth weight* is 2,500 grams (5 lbs. 8 oz. ) and above. *Low birth weight* is anything below 2,500 grams. Among low birthweight babies, there are *moderately low birth weight* babies (who weigh between 1,500 and 2,500 grams) and *very low birthweight* babies (who weigh less than 1,500 grams).

**Birthweight distribution:** The relative frequency of births in various birthweight categories in a population of newborns.

**Birthweight-specific mortality rates:** Mortality rates among newborns classified by birthweight. The birthweight-specific infant mortality rate is defined as the number of infants in a given birthweight interval who die in the first year of life per 1,000 live births in that interval. The birthweight-specific neonatal mortality rate is defined as the number of infants in a given birthweight interval who die in the first 28 days of life per 1,000 live births in that interval.

**Catastrophic stop-loss on out-of-pocket expenses:** Typically, an annual upper limit on the beneficiary's out-of-pocket payments for insured services.

**Cervical cerclage:** A surgical procedure in which the mouth of a woman's cervix is physically cinched together with a suture to attempt to stop the course of premature labor in pregnancy.

**Child maltreatment:** Behavior that falls into one of the following categories: physical abuse or neglect, psychological abuse or neglect, or sexual abuse. Abuse generally implies an act of commission on the part



- of a parent or other caretaker, while neglect implies an act of omission.
- Chronic illness:** Any illness persisting over a long period of time. Compare *acute illness*.
- Coinsurance:** In the context of health insurance, the percentage of the cost of covered services for which the beneficiary is responsible.
- Community health centers (CHCs):** Centers that provide primary health care to medically underserved areas and are part of the primary care program administered by the Federal Bureau of Health Care Delivery and Assistance.
- Congenital:** Existing at birth.
- Congenital adrenal hyperplasia (CAH):** A congenital disorder caused by a deficiency of one or another of the enzymes in the adrenal cortex that is required for normal hormone synthesis. Approximately one-half of all cases are life-threatening if untreated in the first few days of life.
- Congenital hypothyroidism (CH):** A congenital disorder involving a deficiency of the hormone thyroxine needed for brain development and physical growth. If untreated or late treated, congenital hypothyroidism results in mental retardation and physical abnormalities.
- Continuity of care:** A continuous source of medical care (e.g., primary physician, referral to specialist, hospital) or a coordinated system to provide comprehensive children's health care at all levels needed.
- Copayment:** In insurance, a form of cost-sharing whereby the insured pays a specific amount at the point of service or use (e.g., \$10 per visit).
- Cost-effectiveness analysis (CEA):** An analytical technique that compares the costs of alternative projects to the resultant benefits, with costs and benefits/effectiveness expressed by different measures. Costs are usually expressed in dollars, but benefits/effectiveness are ordinarily expressed in terms such as "lives saved," "disability avoided," "quality-adjusted life years saved," or any other relevant objectives. When benefits or effectiveness are difficult to express in a common metric, they should be (but usually aren't) presented as an "array."
- Cost-saving:** An economic concept referring to the results of cost-effectiveness analysis when the net health care costs of implementing one strategy (compared to another) are less than zero.
- Cost-sharing:** That portion of the payment to a provider of health care services that is the liability of the patient and that may include deductibles, copayments, coinsurance, and, under Medicare Part B, unassigned liability. Also, the general set of financial arrangements under which health care insurance is contingent on a purchaser's acceptance of the obligation to pay some portion of the reimbursements for those services.
- Cystic fibrosis (CF):** The most common potentially fatal genetic disease in the white population, caused by a disorder of exocrine glands. Individuals with cystic fibrosis have a variety of physical abnormalities, most serious among them is chronic obstructive lung disease, which is potentially fatal in early adulthood.
- Deductible:** In insurance, an aspect of cost-sharing in which the insured incurs an initial expense of a specified amount within a given time period (e.g., \$250 per year) before the insurer assumes liability for any additional costs of covered services.
- Denver Developmental Screening Test (DDST):** A standardized test, developed in 1967, for the detection of developmental and behavioral problems in children.
- Diphtheria:** An acute infectious disease caused by a bacterium that attacks the throat and nasal passages, interfering with breathing and sometimes producing a toxin that can damage the heart and nerves.
- Diphtheria, tetanus, and pertussis (DTP) vaccine:** A combination vaccine composed of two toxoids (diphtheria and tetanus) and one inactivated whole-cell bacterial vaccine (pertussis).
- Disability:** The presence of one or more functional limitations. A person with a disability has a limited ability or an inability to perform one or more basic life functions (e.g., walking) at a level considered "typical."
- Discounting:** A procedure used in economic analysis to express as "present values" those costs and benefits that will occur in future years. Discounting is based on two premises: 1) individuals prefer to receive benefits today rather than in the future; and 2) resources invested today in alternative programs could earn a return over time.
- Early and Periodic Screening, Diagnosis, and Treatment (EPSDT) program:** A State and federally funded, State-administered preventive health care program that mandates screening and followup of Medicaid-eligible infants and children for any illnesses, abnormalities, or treatable conditions.
- Econometric techniques:** A group of statistical methods used to estimate and test models of economic behavior or systems.
- Effectiveness:** The probability of benefit to individuals in a defined population from a medical technology applied for a given medical problem under average or actual conditions of use.
- False negative:** In medical diagnostics, a negative test result in an individual who actually has the disease or characteristic being tested for. The test incorrectly

- indicates that the individual does not have the particular disease or characteristic.
- False positive:** In medical diagnostics, a positive test result in an individual who does not have the disease or characteristic being tested for. The test incorrectly diagnoses the individual as having the particular disease or characteristic.
- Favorable selection bias in prenatal care studies:** A bias that results from the tendency of women who routinely behave in healthful ways to seek prenatal care early and often. These women are probably healthy on the whole and thus are likely to be at lower than average risk of poor outcomes. Compare *adverse selection bias in prenatal care studies*.
- Fee-for-service payment:** A method of paying for medical services in which each service performed by an individual provider bears a related charge. This charge is paid by the individual patient receiving the service or by an insurer on behalf of the patient.
- Fetal death:** The product of conception, which, after separation from its mother, does not breathe or show other signs of life required to meet the World Health Organization's criteria for a live birth. Compare *live birth*.
- Fetal death rate:** The ratio of fetal deaths to fetal deaths plus live births.
- First dollar deductible:** In the context of insurance, the amount (which may vary by type of benefit) that a beneficiary must pay each year before he or she is eligible for coverage.
- galactosemia:** A deficiency of the enzyme needed to metabolize galactose, a type of sugar found in milk products. Untreated galactosemia usually leads to blood poisoning, progressive liver damage, and death by the first few weeks of life.
- Gestational age:** The number of completed weeks elapsed between the first day of the last normal menstrual period and the date of delivery.
- Haemophilus influenza b (Hib):** The leading cause of serious systemic bacterial disease in the United States, including bacterial meningitis, epiglottitis, sepsis, and pneumonia.
- Head Start:** A Federal program begun in 1965 that provides educational, social, nutritional, and medical services to low-income preschool children. The program is overseen by the Administration for Children, Youth and Families (DHHS), but it is administered at the local level by Head Start agencies.
- Health maintenance organization (HMO):** A health care organization that, in return for prospective per capita (cavitation) payments, acts as both insurer and provider of comprehensive but specified medical services. Prepaid group practices and individual practice associations are types of HMOs.
- Hematocrit:** The volume occupied by the cellular elements of blood in relation to the total volume.
- Hemoglobin (Hgb):** The oxygen-carrying pigment found in red blood cells that serves as the primary oxygen transport vehicle in vertebrates. Hemoglobin is a protein composed of a single iron molecule surrounded by four globin molecules, two each of two different types (two alpha globins and two beta globins in normal adult humans).
- Herd immunity:** The level of immunity that must be attained to prevent epidemics of vaccine-preventable diseases in a specific population.
- High risk:** At greater than normal risk for contracting a specific disease or experiencing a condition.
- Homocystinuria (HC):** A congenital disorder caused by a deficiency of one of the enzymes involved in the metabolism of the amino acid homocystine. If left untreated, homocystinuria can lead to life-threatening episodes of vascular thrombosis; most untreated survivors go on to have mental deficiency, and half of them may die in early adulthood.
- Immunization:** The deliberate introduction of an antigenic substance (vaccine) into an individual, with the aim of producing immunity to a disease. Used interchangeably with vaccination in this report.
- Impairment:** See *disability*.
- Incidence:** The frequency of new occurrences of a disease within a defined time interval. Incidence rate is the number of new cases of a specified disease divided by the number of people in a population over a specified period of time, usually 1 year. Compare *prevalence*.
- Infant mortality:** Death in the first year of life. About 1 percent of all babies born in the United States die in the first year of life. It includes neonatal mortality and postneonatal mortality.
- Infant mortality rate:** The number of deaths among children under 1 year old per 1,000 live births in a given year. The infant mortality rate is the sum of two components: the neonatal mortality rate and the postneonatal mortality rate.
- Inpatient care:** Health care that includes an overnight stay in a medical facility.
- Intrapartum care:** Medical care received during labor and delivery. Compare *postpartum care* and *prenatal care*.
- Live birth:** According to the World Health Organization, "the complete expulsion or extraction from its mother of a product of conception, irrespective of the duration of pregnancy, which, after such separation, breathes or shows any other evidence of life such as beating of the heart, pulsation of the umbilical cord, or definite movement of voluntary muscles." This definition is the basis for most States' re-

- quirements governing the reporting of live births. Compare fetal death.
- Low birthweight:** Birthweight of less than 2,500 grams (5 lbs. 8 oz.).
- Low birthweight rate:** Percentage of live births with birthweight of 2,500 grams or less.
- Major medical coverage:** Health insurance coverage that provides for an array of services and usually includes an annual deductible, coinsurance requirements, and maximum benefit limits. By comparison, basic benefit plans usually provide first-dollar coverage but cover only a very narrow set of services (e.g., hospital, surgical).
- Maple syrup urine disease (MSUD):** A congenital disorder of amino acid metabolism involving the three branched-chain amino acids: leucine, isoleucine, and valine. Classic MSUD results in life-threatening acidemia and neurologic dysfunction in the newborn period, and is fatal if left untreated.
- Maternal and Child Health services (MCH) block grant program:** A Federal block grant program authorized under Title V of the Social Security Act, that provides health services to mothers (e. g., prenatal care) and children (e.g., well-child care). Created by the Omnibus Budget Reconciliation Act of 1981, the MCH block grant consolidated several categorical grant programs into one block grant.
- Maternity care:** Medical services received from conception through labor and delivery. Prenatal care and intrapartum care combined are referred to as maternity care.
- Measles:** A highly communicable viral disease involving primarily a harassing cough with steadily mounting fever followed by the eruption of red papules on the skin.
- Measles, mumps, rubella (MMR) vaccine:** A combination vaccine composed of the three live, attenuated virus vaccines against measles, mumps, and rubella.
- Medicaid:** A federally aided, State-administered program that provides medical assistance for low-income people meeting specific income and family structure requirements.
- Medically needy Medicaid recipients:** States have the option to offer Medicaid to “medically needy” people who would be categorically eligible for Medicaid but whose income and resources lie above the standards for Aid to Families With Dependent Children. Each State sets its own medically needy resource and income standards up to 133 percent of State AFDC income standards.
- Migrant health centers (MHCs):** Centers that provide primary health care to migrant and seasonal farm workers and their families and are part of the primary care program administered by the Federal Bureau of Health Care Delivery and Assistance.
- Moderately low birthweight:** Birthweight between **1,500 and 2,500 grams**.
- Morbidity:** The condition of being diseased.
- Mumps:** A communicable disease caused by a virus that produces painful swelling of the salivary glands in the face and neck. Sometimes other organs may become inflamed.
- Neonatal:** Pertaining to the first **4 weeks (28 days) after birth**.
- Neonatal intensive care: Constant and continuous care of the critically ill newborn.**
- Neonatal intensive care unit (NICU):** A specialized hospital unit combining high technology and highly trained staff that treats seriously ill newborns.
- Neonatal mortality:** Death in the first **28 days** of life.
- Neonatal mortality rate:** The number of deaths during the first **28 days** of life per 1,000 live births.
- Neonate:** A newborn infant less than a month old.
- Newborn screening:** The process of testing asymptomatic newborn infants for diseases that require medical treatment.
- Normal birthweight:** Birthweight of 2,500 grams (5 lbs. 8 oz. ) or above. Compare low *birth weight*.
- Oral polio vaccine (OPV):** A live, attenuated vaccine for the prevention of poliomyelitis. The vaccine is administered orally.
- Outpatient care:** Care that is provided in a hospital and does not include an overnight stay.
- Perinatal:** Pertaining to or occurring in the period shortly before and after birth; variously defined as beginning with the completion of the 20th to 28th week of gestation and ending **7 to 28 days after birth**.
- Perinatal care:** Medical care pertaining to or occurring in the period shortly before and after birth, variously defined as beginning with the completion of the 20th to 28th week of gestation and ending 7 to 28 days after birth.
- Pertussis (whooping cough):** An infectious inflammatory respiratory disease of children caused by the bacterium *Bordetella pertussis*. The disease is characterized by explosive attacks of coughing ending in an inspiratory whoop.
- Phenylketonuria (PKU):** A genetic disorder of amino acid metabolism, characterized by the inability to metabolize the amino acid phenylalanine. Untreated or late treated PKU results in severe mental retardation in the majority of cases.
- Poliomyelitis:** An acute viral disease, occurring sporadically and in epidemics, and characterized clinically by fever, sore throat, headache, and vomiting, often with stiffness of the neck and back. Major

- illness can lead to paralysis.
- Postneonatal mortality:** Death between the first 28 days in life and the first year of life.
- Postneonatal mortality rate:** The number of deaths among infants between 28 days old and 1 year old per 1,000 live births.
- Postpartum care:** Medical services rendered to a mother immediately following a baby's delivery to the sixth week after birth. Compare *intrapartum care* and *prenatal care*.
- Power of a statistical test:** The probability that a specified difference between the experimental and comparison groups in a study will be detected in the experiment.
- Prenatal:** Occurring or formed before birth. Also called "antenatal."
- Prenatal care:** Medical services delivered from conception to labor. Prenatal care and intrapartum care combined are referred to as maternity care. Early prenatal care is care received in the first trimester of pregnancy. Compare *intrapartum care* and *postpartum care*.
- Prevalence:** The frequency of existing cases of a disease or condition within a defined time interval in a defined population. The prevalence rate is the number of existing cases of a disease or other condition in a defined population at a particular time or over a specified time period. Compare *incidence*.
- Preventive Health and Health Services (PHHS) block grant:** A Federal block grant program, created by the Omnibus Budget Reconciliation Act of 1981 (Public Law 97-35), that provides funding to States for a broad array of preventive health services.
- Preventive strategy:** Any action taken by individuals, professionals, or governments to alter the environment, change the behavior of a child or the family, or provide effective health care with the intention of preventing disease or injury.
- Prospective study:** Study in which subjects are assigned to alternatives and observed in an experimental context. Compare *retrospective study*.
- Randomized clinical trial (RCT):** An experiment designed to test the safety and efficacy of a medical technology in which people are randomly allocated to experimental or control groups, and outcomes are compared.
- Respiratory distress syndrome (RDS):** An acute respiratory disorder which, in premature infants, is thought to be caused by a deficiency of pulmonary surfactant. In severe form, patients often need mechanical assistance to breathe.
- Resuscitation:** The return to life or consciousness of one who is apparently dead or whose respirations have ceased.
- Retrospective study:** Study in which effects are observed without any control over the original process of assignment. Compare *prospective study*.
- Rubella (German measles):** A mild viral illness that causes a diffuse reddish rash and swollen lymph glands. Infection in a pregnant woman is of greatest concern, as it can lead to miscarriage, stillbirth, or birth defects.
- School-based clinics:** Clinics in or near junior or senior high schools that typically offer a variety of health care services, including physical examinations, treatment for minor acute illness, preventive services, family planning, pregnancy testing, prenatal care, and screening for venereal disease.
- Self-selection bias:** The likelihood that people who seek more care, or different kinds of care are inherently different in terms of their health risks from those who do not.
- Sensitivity analysis:** A study of the effect of changes in assumptions on the findings of a cost-effectiveness analysis.
- Sensitivity of a test:** The percentage of all those who actually have the condition being tested for who are correctly identified as positive by the test. Operationally, it is the number of true positive test results divided by the number of patients that actually have the disease (true positives divided by the sum of true positives plus false negatives). Compare *specificity of a test*.
- Sickle cell anemia (SCA):** A genetic disorder of hemoglobin synthesis leading to the production of abnormal red blood cells. Infants with sickle cell anemia are at risk of overwhelming infection and sudden death in the first few years of life. Painful episodes of vaso-occlusive crises are the hallmark of sickle cell anemia, although there is wide variability in expression of the disease in older patients.
- Specificity of a test:** The percentage of all those who do not have the condition being tested for who are correctly identified as negative by the test. Operationally, it is the number of negative test results divided by the number of patients that actually have the disease (true negatives divided by the sum of true negatives plus false positives). Compare *sensitivity of a test*.
- Supplemental Security Income (SSI) program:** A Federal income support program for low-income disabled, aged, and blind persons.
- Technology-dependent children:** Children requiring the use of a medical device to compensate for the loss of use of a body function and substantial and complex daily nursing care to avert death or further disability.
- Tetanus:** A noncommunicable disease caused by the

- toxin released from the bacteria *Clostridium tetani* resulting in trismus (“lockjaw”), generalized muscle spasm, arching of the back, glottal spasm, seizures, or respiratory spasms and paralysis.
- Third-party payment:** Payment by a private health insurer or government program to a medical provider for care given to a patient.
- Tocodynamometry:** See *ambulatory tocodynamometry*.
- Tocolytic:** Stopping the onset of premature labor during pregnancy.
- Trimester:** A period of **3 months**.
- Tuberculosis:** A chronic infectious disease of humans and animals caused by any of several species of mycobacteria. It usually begins with lesions in the lung, but can spread to other parts of the body.
- Ultrasound:** High-frequency sound waves that can be focused and used to picture tissues, organs, structures, or tumors within the body.
- Vaccination:** The deliberate introduction of an antigenic substance (vaccine) into an individual with the aim of producing immunity to a disease. Used interchangeably with the term immunization in this report.
- Vaccine:** A preparation of living, attenuated, or killed bacteria or viruses, fractions thereof, or synthesized antigens identical or similar to those found in the disease-causing organisms, that is administered to produce or increase immunity to a particular disease.
- Validity:** A measure of the extent to which an observed situation reflects the “true” situation. Internal validity is a measure of the extent to which study results reflect the true relationship of a technology to the outcome of interest in the study subjects. External validity is a measure of the extent to which study results can be generalized to the population which is represented by individuals in the study.
- Varicella:** Chickenpox.
- Very low birthweight:** Birthweight of less than 1,500 grams (3 lbs. 5 oz.).
- Well-child care:** Preventive health care for children, including immunization, physical examinations and other tests that screen for illness or developmental problems, health education, and parental guidance.

# References

# References

1. Aber, L. J., Barnard College, New York, NY, personal communication, December 1986.
2. Aday, L. A., Andersen, R. M., and Fleming, G. V., *Health Care in the U. S.: Equitable for Whom?* (Beverly Hills, CA: Sage Publications, 1980).
3. Agran, P. F., and Wehrle, P. F., "Injury Reduction by Mandatory Child Passenger Safety Laws," *Am. J. Public Health* 75(2):128-129, 1985.
4. Agran, P. F., Dunkle, D. E., and Winn, D., "Noncrash Motor Vehicle Accidents: Injuries to Children in the Vehicle Interior," *Am. J. Dis. Child.* 139:304, 1985.
5. Alan Guttmacher Institute, Physician Survey 1983, unpublished data on physician participation in Medicaid, New York, NY, 1983.
6. Alberti, P. W., Hyde, M. L., Riko, K., et al., "Issues in Early Identification of Hearing Loss," *Laryngoscope* 95:373-381, 1985.
7. Alexander, C. S., and Klassen, A. C., "Curtailment of Well-Child Services by a Local Health Department: Impact on Rural 2-Year-Olds," *Public Health Reports* 101:301-308, 1986.
8. Alexander, G. R., Tompkins, M. E., Altekruze, J. M., et al., "Racial Differences in the Relation of Birth Weight and Gestational Age to Neonatal Mortality," *Public Health Reports* 100(5): 539-546, 1985.
9. Allen, D. B., and Bergman, A. B., "Social Learning Approaches to Health Education: Utilization of Infant Auto Restraint Devices," *Pediatrics* 58:323-328, 1976.
10. Alpert, J. J., Robertson, L. S., Kosa, J. K., et al., "Delivery of Health Care for Children: Report of an Experiment," *Pediatrics* 57:917-930, 1976.
11. Altmeier, W. A., "Antecedents of Child Abuse," *J. Pediatrics* 100:823, 1982.
12. Amato, R. S., Johns Hopkins Hospital, Baltimore, MD, personal communication, 1987.
13. Ambrosch, F., and Wiederman, G., "Costs and Benefits of Measles and Mumps Immunization in Austria," *Bull. World Health Organization* 57(4):625-629, 1979.
14. American Academy of Family Physicians, *Recommended Immunization Schedule for Children*, brochure, Kansas City, MO, revised January 1987.
15. American Academy of Pediatrics, *Standards for Child Health Care*, 3d ed. (Evanston, IL: 1977).
16. American Academy of Pediatrics, "New Issues in Newborn Screening for Phenylketonuria and Congenital Hypothyroidism," *Pediatrics* 69(1): 104-106, 1982.
17. American Academy of Pediatrics, *Guidelines for Health Supervision* (Elk Grove Village, IL: 1985).
18. American Academy of Pediatrics, "Trends in Pediatrician Participation in State Medicaid Programs, State Report for California," *Working Paper #11-A* (Elk Grove Village, IL: 1985).
19. American Academy of Pediatrics, Elk Grove Village, IL, personal communication, November 1986.
20. American Academy of Pediatrics, Committee on Practice and Ambulatory Medicine, "Guidelines for Health Supervision of Children and Youth," information sheet, Elk Grove Village, IL, 1981.
21. American Academy of Pediatrics, Committee on Standards of Child Health Care, "Recommendations for Preventive Health Care of Children and Youth," *AAP News and Comment* (suppl.), June 1974.
22. American Academy of Pediatrics and American College of Obstetricians and Gynecologists, *Guidelines for Perinatal Care* (Evanston, IL: 1983).
23. American Association for Protecting Children, *Highlights of Official Child Neglect and Abuse Reporting—1983* (Denver, CO: American Humane Association, 1985).
24. American Association for Protecting Children, *Highlights of Official Child Neglect and Abuse Reporting—1984* (Denver, CO: American Humane Association, 1986).
25. American College of Obstetricians and Gynecologists, *Standards for Obstetric-Gynecologic Services*, 6th ed. (Washington, DC: 1985).
26. American Hospital Association, Washington, DC, *National Hospital Panel Survey Report*, December 1986.
27. American Medical Association, *Physician Characteristics and Distribution in the U. S.: 1979 Edition* (Chicago, IL: 1980).
28. American Medical Association, *Physician Characteristics and Distribution in the U. S.: 1984 Edition* (Chicago, IL: 1985).
29. Amoni, M., National Highway Traffic Safety Administration, U.S. Department of Transport-

- tation, Washington, DC, personal communication, June 1987.
30. Anderson, F. P., "Evaluation of the Routine Physical Examination of Infants in the First Year of Life," *Pediatrics* 45:950-964, 1970.
  31. Andrews, L.B. (cd.), *Legal Liability and Quality Assurance in Newborn Screening* (Chicago, IL: American Bar Foundation, 1985).
  32. Andrews, L. B., *State Laws and Regulations Governing Newborn Screening* (Chicago, IL: American Bar Foundation, 1985).
  33. Armstrong, K. A., "A Treatment and Education Program for Parents and Children Who Are At-Risk of Abuse and Neglect," *Child Abuse & Neglect* 5:167-175, 1981.
  34. Armstrong, K. A., "Economic Evaluations of Medicines: A Review of the Literature," *Child Welfare* 62:3, 1983.
  35. Atten, D. W., and Milner, J. S., "Child Abuse Potential and Work Satisfaction in Day-Care Employees," *Child Abuse & Neglect* 11(1):117-123, 1987.
  36. Augustin, M. S., Stevens, E., and Hicks, D., "An Evaluation of the Effectiveness of a Children and Youth Project," *Health Services Report* 88:942-946, 1973.
  37. Axnick, N., Shaven, S., and Witte, J., "Benefits Due to Immunization Against Measles," *Public Health Reports* 84(8):673-680, 1969.
  38. Azzara, C. V., Massachusetts Department of Public Health, Boston, MA, personal communication, June 1987.
  39. Azzara, C. V., Gallagher, S. S., and Guyer, B., "The Relative Health Care and Social Costs for Specific Causes of Injury," paper presented at the American Public Health Association meeting, Washington, DC, Nov. 18, 1985.
  40. Bailey, S., "The Maternal and Child Health Services Block Grant, Title V of the Social Security Act," Report No. 83-93 EPW, Congressional Research Service, Washington, DC, May 5, 1983.
  41. Baker, S. P., "Childhood Injuries: The Community Approach to Prevention," *J. Public Health Policy* 2(3):235-246, 1981.
  42. Baker, S. P., O'Neill, B., and Karpf, R. S., *The Injury Fact Book* (Lexington, MA: Lexington Books, D.C. Heath & Co., 1984).
  43. Baker, S. P., Whitfield, R. A., and O'Neill, B., "Geographic Variations in Mortality From Motor Vehicle Crashes," *N. Eng. J. Med.* 316(22):1384-1387, 1987.
  44. Baldwin, J. A., and Oliver, J. E., "Epidemiology and Family Characteristics of Sexually Abused Children," *Br. J. Prev. Soc. Med.* 29:205, 1975.
  45. Ball, J. K., "Preventive Medical Care for the Poor: The Impact of Medicaid on Utilization," presentation at the 113th Annual Meeting of the American Public Health Association, Washington, DC, Nov. 17-21, 1985.
  46. Barden, H. S., and Kessel, R., "The Costs and Benefits of Screening for Congenital Hypothyroidism in Wisconsin," *Social Biology* 31(3-4):185-200, 1984.
  47. Barden, H. S., Kessel, R., and Schuett, V. E., "The Costs and Benefits of Screening for PKU in Wisconsin," *Social Biology* 31(1-2):1-17, 1984.
  48. Barden, T. P., Peter, J. B., and Merkatz, I. R., "Ritodrine Hydrochloride: A Betamimetic Agent for Use in Preterm Labor," *Obstet./Gynecol.* 56(1):1-6, 1980.
  49. Barid, S., "Impediments to Age Appropriate Immunization," paper presented at the American Public Health Association meeting, Washington, DC, Nov. 17-21, 1985.
  50. Barid, S., Centers for Disease Control, Public Health Service, U.S. Department of Health and Human Services, Atlanta, GA, personal communication, October 1986.
  51. Bass, J. L., Mehta, K. A., Ostrovsky, M., et al., "Educating Parents About Injury Prevention," *Peel. Clin. North Am.* 32(1):233-241, 1985.
  52. Bass, L. W., and Wilson, T. R., "The Pediatrician's Influence in Private Practice Measured by a Controlled Seat Belt Study," *Pediatrics* 33:700-704, 1964.
  53. Bayse, D.D. (cd.), *Proceedings of a Conference on a National Model for Standardization of Neonatal Hypothyroid Screening Programs* (Atlanta, GA: U.S. DHHS, PHS, CDC, 1980).
  54. Berger, L. B., "Public/Private Cooperation in Rural Maternal Child Health Efforts: The Lea County Perinatal Program," *Texas Medicine* 80:54-57, September 1984.
  55. Bergner, L., "Environmental Factors in Injury Control: Preventing Falls From Heights," *Preventing Childhood Injuries*, A.B. Bergman (cd.) (Columbus, OH: Ross Laboratories, 1982).
  56. Berkeley Planning Associates, *The Exploration of Client Characteristics, Services, and Outcome: Evaluation of the Clinical Demonstration of Child Abuse and Neglect* (Berkeley, CA: 1982).
  57. Bickel, H., Bachman, C., Bechers, R., et al., "Neonatal Mass Screening for Metabolic Disorders," *Eur. J. Pediatrics* 137:133-139, 1981.
  58. Birch & Davis Associates, Inc., *Developing Childhood Injury Prevention Programs: An Administrative Guide for State Maternal and*



- Child Health (Title V) Programs*, submitted to the Division of Maternal and Child Health, Bureau of Health Care Delivery and Assistance, Health Resources and Services Administration, Public Health Service, U.S. Department of Health and Human Services (Silver Spring, MD: February 1983).
59. Bithoney, W. G., Snyder, J., Michalek, J., et al., "Childhood Ingestions as Symptoms of Family Distress," *Am. J. Dis. Child.* 139(5):456-9, 1985.
  60. Black, D. A. K., *Inequalities in Health: Report of a Research Working Group* (London, England: Department of Health and Social Services, 1980).
  61. Blackwell, A. G., Salisbury, L., and Arriola, A. P., Public Advocates, Inc., San Francisco, CA, "Administrative Petition To Reduce the Incidence of Low Birth Weight and Resultant Infant Mortality," administrative petition to the U.S. Department of Health and Human Services, 1983.
  62. Bloch, A. B., Orenstein, W. A., Stetler, H. C., et al., "Health Impact of Measles Vaccination in the United States," *Pediatrics* 76(4):524-532, 1985.
  63. Boodman, S. G., "Born Dying: AIDS' 2nd Generation," *Washington Post*, p. 1, Mar. 23, 1987.
  64. Boone, J., Clinical Chemistry Toxicology Lab program office, Centers for Disease Control, Public Health Service, U.S. Department of Health and Human Services, Atlanta, GA, unpublished data on proficiency testing results, 1986.
  65. Bourne, R., "Child Abuse and Neglect: An Overview," *Critical Perspectives on Child Abuse*, R. Bourne and E.H. Newberger (eds.) (Lexington, MA: Lexington Books, D.C. Heath & Co., 1978).
  66. Brenner, M. H., "Estimating the Effects of Economic Change on National Health and Social Well-Being," Subcommittee on Economic Goals and Intergovernmental Policy, Joint Economic Committee, U.S. Congress, Washington, DC, Sp. Rpt. 98-198, 1984.
  67. Breslau, N., and Haug, M., "Service Delivery Structure and Continuity of Care: A Case Study of a Pediatric Practice in Process of Reorganization," *J. Health & Social Behav.* 17:339-352, 1976, as cited in Flint, 1987.
  68. Breslau, N., and Reeb, K., "Continuity of Care in a University Based Practice," *J. Medical Educ.* 50:965-969, 1975, as cited in Flint, 1987.
  69. Briscoe, M. E., Hochstrasser, D. L., Somes, G. W., et al., "Followup Study of the Impact of a Rural Preventive Care Outreach Program on Children's Health and Use of Medical Services," *Am. J. Public Health* 70:151-156, 1980.
  70. British Committee on Child Health Services (S. D.M. Court, Chair), *Fit for the Future* (London, England: Her Majesty's Stationery Office, 1976).
  71. British Department of Health and Social Services, Scottish Home and Health Department, Welsh Office, Joint Committee on Vaccination and Immunisation for the Secretary of State for Social Services, the Secretary of State for Scotland and the Secretary of State for Wales, *Immunisation Against Infectious Disease* (London, England: Crown Copyright, 1984).
  72. Brooten, E., Kumar, S., Brown, L., et al., "A Randomized Clinical Trial of Early Hospital Discharge and Home Followup of Very Low Birthweight Infants," *N. Eng. J. Med.* 315(15): 934-939, 1986.
  73. Brown, M. J. K., Richards, S. H., and Ambergaokar, A. G., "Grommets and Ear Glue: A Five-Year Followup of a Controlled Trial," *J. Royal Soc. Med.* 71:353-356, 1978.
  74. Brownell, A., and Shumaker, S. A., "Social Support: Introduction to a Complex Phenomenon," *J. Social Issues* 40:1, 1984.
  75. Brunell, P. A., "Varicella Vaccine—Where Are We?" *Pediatrics* 78(4) Part II:721-722, 1986.
  76. Brunnequell, D., Crichton, L., and Egeland, B., "Maternal Personality and Attitude in Disturbances of Child Rearing," *Am. J. Orthopsych.* 51:680-91, 1981.
  77. Buckwald, S., Zorn, W. A., and Egan, E. A., "Mortality and Followup Data for Neonates weighing 500 to 800 G at Birth," *Am. J. Dis. Child.* 138:779-782, 1984.
  78. Budetti, P., McManus, P., Barrand, N., et al., *The Costs and Effectiveness of Neonatal Intensive Care* (Health Technology Case Study #10), prepared for the Office of Technology Assessment, U.S. Congress, OTA-BP-H-9(10) (Springfield, VA: National Technical Information Service, August 1981).
  79. Buehler, J. W., Hogue, C. J., and Samuels, B. N., "Postponing or Preventing Deaths? Trends in Infant Survival" (letter), *J. A.M.A.* 256(9):1140, 1986.
  80. Buehler, J. W., Kleinman, J. C., Hogue, C. J., et al., "Birthweight-Specific Infant Mortality, United States, 1960 and 1980," *Public Health Reports* 102(2):151-161, 1987.
  81. Buist, N., Oregon Health Sciences University, Portland, OR, personal communication, May 1987.
  82. Buist, N., Nelson, D., and Tuerck, J. M., "Dys-

- praxia in Treated Galactosemic Patients," Sixth International Neonatal Screening Symposium, Austin, TX, Nov. 16-19, 1986.
83. Burke, V. W., "Welfare and Poverty Among Children," *Congressional Research Service Review* 8(7):1-23, 1987.
  84. Burt, M. R., Kimmich, M. H., Goldmuntz, J., et al., *Helping Pregnant Adolescents: Outcomes and Costs of Service Delivery* (Washington, DC: Urban Institute Press, February 1984).
  85. Bush, J. W., Chen, M. M., and Patrick D. L., "Health Status Index in Cost Effectiveness: Analysis of PKU Program," *Health Status Indexes*, R. Berg (ed.) (Chicago, IL: Hospital Research and Educational Trust, 1973).
  86. Butler, J. A., Winter, W. D., Singer, J. D., et al., "Medical Care Use and Expenditure Among Children and Youth in the United States: Analysis of a National Probability Sample," *Pediatrics* 76(4):495-507, 1985.
  87. Cadman, D., Chambers, L. W., Walter, S. D., et al., "Evaluation of Public Health Preschool Child Developmental Screening: The Process and Outcomes of a Community Program," *Am. J. Public Health* 77:45-51, 1987.
  88. Camp, B. W., van Doorninck, W. J., Frankenburg, W. K., et al., "Preschool Developmental Testing in Prediction of School Problems," *Clinical Pediatrics* 16:257-263, 1977.
  89. Canadian Department of National Health and Welfare, Health Services and Promotion Branch, Task Force on the Periodic Health Examination, *The Periodic Health Examination, 1979* (Ottawa, ON: Department of National Health and Welfare, 1979).
  90. Canadian Department of National Health and Welfare, Health Services and Promotion Branch, Task Force on the Periodic Health Examination, *The Periodic Health Examination: 1984* (Ottawa, ON: Department of National Health and Welfare, 1984).
  91. Canadian Diseases Weekly Report, "National Advisory Committee on Immunization (NACI): Statement on *Haemophilus b* Polysaccharide Vaccine," *Canadian Diseases Weekly Report* 12(9):33-35, 1986.
  92. Canadian Pediatric Society, *Child Health Care Guidelines* (Ottawa, ON: March 1983).
  93. Cantekin, E. I., Mandel, E. M., Bluestone C. D., et al., "Lack of Efficacy of a Decongestant-Antihistamine Combination for Otitis Media in Children," *N. Eng. J. Med.* 308:297-301, 1983.
  94. Carpenter, R. G., Gardner, A., Jepson, M., et al., "Prevention of Unexpected Infant Death," *Lancet* 1:723-727, 1983.
  95. Casey, P., Sharp, M., and Loda, F., "Child-Health Supervision for Children Under 2 Years of Age: A Review of Its Content and Effectiveness," *J. Pediatrics* 95:1-9, 1979.
  96. Casey, P. H., Bradley, R. H., Caldwell, B. M., et al., "Developmental Intervention: A Pediatric Clinical Review," *Peal. Clin. North Am.* 33:899-923, 1986.
  97. Casey, P. H., and Whitt, J. K., "Effect of the Pediatrician on the Mother-Infant Relationship," *Pediatrics* 65:815-820, 1980.
  98. Casscells, W., "Estimated Costs of Heart Transplantation," abstract, *Clinical Research* 33:245a, 1985.
  99. Cates, K. L., "*Haemophilus Influenza* Type b Polysaccharide Vaccine," *Pediatric Annals* 15(6):461-468, 1986.
  100. Chafee-Bahamon, C., and Lovejoy, F. H., "Effectiveness of a Regional Poison Center in Reducing Excess Emergency Room Visits for Children's Poisonings," *Pediatrics* 72(2):164-169, 1983.
  101. Chamberlain, R. W., "Developmental Assessment and Early Intervention Programs for Young Children: Lessons Learned From Longitudinal Research," *Pediatrics in Review* 8:237-47, 1987.
  102. Chamberlain, R. W., and Szumowski, B. A., "A Followup Study of Parent Education in Pediatric Office Practices: Impact at Age Two and a Half," *Am. J. Public Health* 70:1180-1188, 1980.
  103. Charney, E., "Well-Child Care as Axiom," *Well-Child Care, Report of the Seventeenth Ross Roundtable on Critical Approaches to Common Pediatric Problems*, E. Charney (ed.) (Columbus, OH: Ross Laboratories, 1986).
  104. Children's Defense Fund, "Medicaid Reform," *Campaign Notes* 3:1-17, July 1986.
  105. Chollet, D. J., *Employer-Provided Health Benefits: Coverage, Provisions and Policy Issues* (Washington, DC: Employee Benefit Research Institute, 1984).
  106. Cislowski, J. A., "Current Welfare System: Expanded Medical Care," U.S. Congress, paper prepared by the Congressional Research Service, U.S. Congress, Washington, DC, July 1987.
  107. Coalition for the Homeless, *A Crying Shame: Official Neglect of Homeless Infants* (New York, NY: 1985).
  108. Cochi, S. L., Centers for Disease Control, Public Health Service, U.S. Department of Health and Human Services, Atlanta, GA, personal communication, March 1987.
  109. Cochi, S. L., and Broome, C. V., "Vaccine Prevention of *Haemophilus Influenzae* Type b Dis-

- ease: Past, Present and Future," *Peal. infect. Diseases* 5(1): 12-19, 1986.
110. Cochi, S. L., Broome, C. V., and A.W. High tower, "Immunization of U.S. Children With *Haemophilus Influenzae* Type b Polysaccharide Vaccine: A Cost-Effectiveness Model of Strategy Assessment," *J. A.M.A.* 253(4):521-529, 1985.
  111. Cochi, S. L., Fleming, D. W., Hull, H. F., et al., "Haemophilus b(Hib)Polysaccharide Vaccine: Physician Acceptance and Use of a New Vaccine," *Am. J.Dis. Child.*140:1226-1230, 1986.
  112. Cochran, M., and Bronfenbrenner, U., "Child Rearing, Parenthood, and the World of Work," *11'(irk in America: The Decade Ahead*, C. Kerr and J.Roson(eds. ) (New York, NY: Van Nostrand Reinhold, 1979).
  113. Cohen, 1., *Statistical Power Analysis for the Behavioral Sciences* (New York, NY: Academic Press, 1977).
  114. Coleman, M., and Marquardt, A., "Screening Status Reports," *Infant Screening Newsletter* 8(1):2, 1985.
  115. Coleman, M., and Marquardt, A., "Screening Status Reports," *Infant Screening Newsletter* 9(1):2, 1986.
  116. Committee on Sexual Offences Against Children and Youths, *Sexual Offenses Against Children, vol. 1* (Ottawa, ON: Canadian Government Publishing Center, 1984) as cited in Finkelhor and Arajii, 1986.
  117. Conway, P., Budget Office, Bureau of Health Care Delivery and Assistance, Health Services and Resources Administration, U.S. Department of Health and Human Services, Rockville, MD, personal communication, September 1987.
  - 117a. Cooney, J., "What Determines the Start of Prenatal Care? Prenatal Care, Insurance, and Education," *Medical Care* 23(8):986-997, 1985.
  118. Corman, H., and Grossman, M., "Determinants of Neonatal Mortality Rates in the U.S.," *J. Health Economics* 4:213-236, 1985.
  119. Corman, H., Joyce, T. J., and Grossman, M., "Birth Outcome Production Functions in the U.S.," *J. Human Resources* 22(3):339-360, 1987.
  120. Crandall, R. W., Gruenspecht, H. K., Keeler, T. E., et al., *Regulating the Automobile* (Washington, DC: Brookings Institution, 1986).
  121. Cullen, K. J., "A Six-Year Controlled Trial of Prevention of Children's Behavior Disorders," *J.Pediatrics* 88:662-666, 1976.
  122. Currier, R., "Is Early and Periodic Screening, Diagnosis, and Treatment (EPSDT) Worthwhile?" *Public Health Reports* 92(6) :527-536, 1977.
  123. Dagenais, D. L., Courville, L., and Dagenais, M. G., "A Cost-Benefit Analysis of the Quebec Network of Genetic Medicine," *Soc.Sci.Med.* 20(6):601-607, 1985.
  124. Dare, D., National Committee for Prevention of Child Abuse, Chicago, IL, personal communication, December 1986.
  125. Dare, D., *Confronting Child Abuse: Theory, Policy and Practice* (New York, NY: Free Press, in press).
  126. David, R. J., "Did Low Birthweight Among U.S. Blacks Really Increase?" *Am. J.Public Health* 76(4):380-384, 1986.
  127. Davidson, S., Perloff, J., Kletke, P., et al., "Medicaid Participation: Full and Limited Participants," *Pediatrics* 72:552-559, 1983.
  128. Davis, K., and Schoen C., "Medical Care for Mothers and Children: The Maternal and Child Health Program," *Health and the War on Poverty: A Ten-Year Appraisal*, K. Davis and C. Schoen (eds.) (Washington, DC: Brookings Institution, 1978).
  129. DeAngelis, C., Berman, B., Oda, D., et al., "Comparative Values of School Physical Examinations and Mass Screening Tests," *J. Pediatrics* 102:477-481, 1983.
  130. Decker, M. D., Devey, M. J., Hutcheson, R. H., et al., "The Use and Efficacy of Child Restraint Devices," *J. A.M.A.* 252(18):2571-2575, 1984.
  131. Deinard, A., Gilbert, A., Dodds, M., et al. "Iron Deficiency and Behavioral Deficits," *Pediatrics* 68:828-833, 1981.
  132. Deinard, A. S., List, A., Lindgren, B., et al., "Cognitive Deficits in Iron-Deficient and Iron-Deficient Anemic Children," *J. Pediatrics* 108: 681-689, 1986.
  133. Dempsey, W. H., testimony before the Subcommittee on Surface Transportation, Committee on Public Works and Transportation, U.S. House of Representatives, U.S. Congress, Washington, DC, June 5, 1985.
  134. Dershewitz, R. A., "Home Safety: Is Anticipatory Guidance Effective?" *Preventing Childhood Injuries*, A.B. Bergman (cd. ) (Columbus, OH: Ross Laboratories, 1982).
  135. Dershewitz, R. A., and Williamson, J. W., "Prevention of Childhood Household Injuries: A Controlled Clinical Trial," *Am. J.Public Health* 67:1148, 1977.
  136. Dietz, P. E., and Baker, S. P., "Drowning: Epidemiology and Prevention," *Am. J. Public Health* 64:303, 1974.
  137. Done, A. K., "Aspirin Overdosage: Incidence, Diagnosis and Management," *Pediatrics* 62-(suppl.):890-897, 1978.

138. Donnell, G. N., Koch, R., Fishier K., et al., "Clinical Aspects of Galactosaemia," *Inherited Disorders of Carbohydrate Metabolism*, D. Burman, J.B.Holton, and C.A. Pennock, et al. (eds.) (Baltimore, MD: University Park Press, 1980).
139. Dott, A. B., and Fort, A. T., "The Effect of Availability and Utilization of Prenatal Care and Hospital Services on Infant Mortality Rates," *Am. J. Obstet. Gynecol.* 123(8):854-860, 1975.
140. Doubilet, P., Weinstein, M. C., and McNeil, B. J., "Use and Misuse of the Term 'Cost Effective' in Medicine," *N. Eng. J. Med.* 314(4):253-256, 1986.
141. Driggers, D. A., Reeves, J. D., Lo, E. Y. L., et al., "Iron Deficiency in One-Year-Old Infants: Comparison of Results of a Therapeutic Trial in Infants With Anemia or Low-Normal Hemoglobin Values," *J. Pediatrics* 98:753-758, 1981.
142. Dryfoos, J., "School-Based Health Clinics: A New Approach to Preventing Adolescent Pregnancy?" *Fare. Plan. Perspectives* 17(2):70-75, 1985.
143. Dubowitz, H., "Child Maltreatment in the United States: Etiology, Impact, and Prevention," prepared for the Office of Technology Assessment, U.S. Congress, Washington, DC, October 1986.
144. Dutton, D. B., and Silber, R. S., "Children's Health Outcomes in Six Different Ambulatory Care Delivery Systems," *Medical Care* 18:693-714, 1980.
145. Eberstein, I., White, D., and Weller, R., Florida State University, Gainesville, FL, unpublished data from the 1980 National Natality Survey, prepared for the Office of Technology Assessment, U.S. Congress, Washington, DC, 1986.
146. Eddins, D., Division of Immunization, Centers for Disease Control, Public Health Service, U.S. Department of Health and Human Services, Atlanta, GA, personal communication, October 1987.
147. Edwards, L. E., Steinman, M. E., Arnold, K. A., et al., "Adolescent Pregnancy Prevention Services in High School Clinics," *Fare. Plan. Perspectives* 12(1):6-14, 1980.
148. Egeland, B., and Brunnuell, D., "An At-Risk Approach to the Study of Child Abuse: Some Preliminary Findings," *J. Am. Acad. Child Psych.* 18:219, 1979.
149. Eisner, V., Brazie, J. V., Pratt, M. W., et al., "The Risk of Low Birthweight," *Am. J. Public Health* 69(9):887-893, 1979.
150. Ekblom, M., Elo, O., and Niemela, P., "Costs and Benefits of Measles Vaccination in Finland," *Scand. J. Soc. Med.* 6(3):111-115, 1978.
151. Ellerstein, N.S. (ed.), *Child Abuse Neglect: A Medical Reference* (New York, NY: John Wiley & Sons, 1981).
152. Elmer, E., "A Followup Study of Traumatized Children," *Pediatrics* 59:273, 1977.
153. Elster, A. B., "The Effect of Maternal Age, Parity, and Prenatal Care on Perinatal Outcome in Adolescent Mothers," *Am. J. Obstet. Gynecol.* 149(8):845-847, 1984.
154. Elster, A. B., Lamb, M. E., Tavare, J., et al., "The Medical and Psychosocial Impact of Comprehensive Care on Adolescent Pregnancy and Parenthood," *J.A.M.A.* 258(9):1187-1192, 1987.
155. Embury, S. H., Scharf, S. J., Saiki, R. K., et al., "Rapid Prenatal Diagnosis of Sickle Cell Anemia by a New Method of DNA Analysis," *N. Eng. J. Med.* 316(11):656-661, 1987.
156. Enkin, M., and Chalmers, I. (eds.), *Effectiveness Satisfaction in Antenatal Care* (Philadelphia, PA: J.B. Lippincott Co., 1982).
157. Enos, W. F., Conrath, T. B., and Byer, J. C., "Forensic Evaluation of the Sexual Abused Child," *Pediatrics* 78(3):385-398, 1986.
158. Erickson, J. D., and Bjerkedal, T., "Fetal and Infant Mortality in Norway and the United States," *J. A.M.A.* 247(7):987-991, 1982.
159. Ershoff, D. H., Aaronson, N. K., Danaher, B. G., et al., *Cost-Benefit Analysis of a Comprehensive Prenatal Health Education Program Within an HMO Setting, Executive Summary*, prepared for the Office of Health Information, Health Promotion and Physical Fitness and Sports Medicine, Public Health Service, U.S. Department of Health and Human Services, Washington, DC, July 1982.
160. Ershoff, D. H., Aaronson, N. K., Danaher, B. G., et al., "Behavioral, Health, and Cost Outcomes of an HMO-Based Prenatal Health Education Program," *Public Health Reports* 98(6):536-547, 1983.
161. Eskola, J., Peltola, H., Takala, A., et al., "Efficacy of *Haemophilus Influenzae* Type b Polysaccharide-Diphtheria Toxoid Conjugate Vaccine in Infancy," *N. Eng. J. Med.* 317(12):717-722, 1987.
162. Evans, R. W., Manninen, D. L., Overcast, T. D., et al., *The National Heart Transplantation Study: Final Report* (Seattle, WA: Battelle Human Affairs Research Centers, 1984).
163. Fanshel, D., "Decision-Making Under Uncertainty: Foster Care for Abused or Neglected

- Children?" *Am. J. Public Health* 71:685-686, 1981.
164. Farber, M., and Finkelstein, S., "A Cost-Benefit Analysis of a Mandatory Premarital Rubella-Antibody Screening Program," *N. Eng. J. Med.* 300(15):856-859, 1979.
  165. Farley, P. J., and Walden, D.C., "The Privately Insured Under Age 65: Cost-Sharing, Depth of Benefits, and Other Aspects of Their Health Insurance," paper presented at the 1983 meeting of the American Public Health Association, Dallas, TX, November 1983.
  166. Farrell, P. M., "Pulmonary Benefits of Cystic Fibrosis Neonatal Screening," unpublished manuscript, University of Wisconsin, Madison, WI, 1986.
  167. Feck, G., Baptiste, J. S., and Tate, C. L., *An Epidemiologic Study of Burn Injuries and Strategies for Prevention* (Albany, NY: New York Department of Health, 1977).
  168. Feldman, W., Milner, R. A., Backett, B., et al., "Effects of Preschool Screening for Vision and Hearing on Prevalence of Vision and Hearing Problems 6-12 Months Later," *Lancet* 2:1014, 1980.
  169. Felice, M. E., Granados, J. L., Ances, I. G., et al., "The Young Pregnant Teenager: Impact of Comprehensive Prenatal Care," *J. Adol. Health Care* 1(3):193-197, 1981.
  170. Finkelhor, D., "Risk Factors in Sexual Victimization of Children," *Child Abuse & Neglect* 4:265, 1980.
  171. Finkelhor, D., *Child Sexual Abuse: New Theory and Research* (New York, NY: Free Press, 1984).
  172. Finkelhor, D., and Araji, S., *A Source Book on Child Sexual Abuse* (Beverly Hills, CA: Sage Publications, 1986).
  173. Finkelhor, D., and Hotaling, G. T., "Sexual Abuse in the National Incidence Study of Child Abuse and Neglect: An Appraisal," *Child Abuse & Neglect* 8:23-33, 1984.
  174. Fisch, L., "Development of School Screening Audiometry," *Br. J. Audiology* 15:87-95, 1981.
  175. Fisch, R., Bilek, O. M., and Bruhl, H., "Causes of Death of Institutionalized Phenylketonuric (PKU) Patients: A National Survey," *Minnesota Medicine* 53:306-309, 1976.
  176. Fisher, E.S., LoGerfo, J. P., and Daling, J. R., "Prenatal Care and Pregnancy Outcomes During the Recession: The Washington State Experience," *Am. J. Public Health* 75(8):866-869, 1985.
  177. Fisher, L., "Childhood Injuries—Causes, Preventive Theories and Case Studies: An Overview on the Role for Sanitarians and Other Health Professionals," paper presented at the National Environmental Health Association's Annual Educational Conference, San Diego, CA, June 14, 1987.
  178. Fisher, L., Van Buren, J., Lawrence, R. A., et al., "Genesee Region Poison Prevention Project: Phase II," *Vet. Hum. Toxicology* 28(2):123-126, 1986.
  179. Flint, S. S., "The Impact of Continuity of Care on the Utilization and Cost of Pediatric Care in a Medicaid Population," unpublished Ph.D. dissertation, University of Chicago, Chicago, IL, March 1987.
  180. Fomufod, A., Sinkford, S. M., and Louy, V. E., "Mother-Child Separation at Birth: A Contributing Factor in Child Abuse" (letter), *Lancet* 2:549-550, 1975.
  181. Forrest, J. D., and Singh, S., "Timing of Prenatal Care in the United States: How Accurate Are Our Measurements?" *Health Services Research* 22(2):235-254, 1987.
  182. Forsman I., Division of Maternal and Child Health, Bureau of Health Care Delivery and Assistance, Public Health Service, U.S. Department of Health and Human Services, Rockville, MD, personal communication, 1986.
  183. Foster, S. E., *Preventing Teenage Pregnancy* (Washington, DC: Council of State Policy and Planning Agencies, 1986).
  184. Fox, H. B., Fox, Inc., Washington, DC, "Medicaid Options for Financing the Care of Children and Pregnant Women," memorandum to State Maternal and Child Health Directors, Feb. 22, 1985.
  185. Fox, H. B., and Yoshpe, R., "Private Health Insurance Coverage of Chronically 111 Children," prepared for the National Center for Networking Community-Based Services, Georgetown University Child Development Center, Washington, DC, March 1986.
  186. Foxman, B., Lohr, K. N., and Brook, R. H., *Measurement of Physiologic Health for Children, Vol. 5: Anemia* (Santa Monica, CA: Rand Corp., 1983).
  187. Frankenburg, W. K., "Developmental Assessment," *Developmental and Behavioral Pediatrics*, M.D. Levine, W.B. Carey, A.C. Crocker, et al. (eds.) (Philadelphia, PA: W.B. Saunders, 1983).
  188. Galdston, R., "Observations on Children Who Have Been Physically Abused and Their Parents," *Am. J. Orthopsych.* 122:440, 1965.

189. Gallagher, S., Director, Childhood Injury Prevention Resource Center, Boston MA, personal communication, June 1987.
190. Gallagher, S. S., Finison, K., Guyer, B., et al., "The Incidence of Injuries Among 87,000 Massachusetts Children and Adolescents: Results of the 1980-81 Statewide Childhood Injury Prevention Program Surveillance System," *Am. J. Public Health* 74(12):1340-1347, 1984.
191. Gallagher, S. S., Hunter, P., and Guyer, B., "A Home Injury Prevention Program for Children," *Ped. Clin. North. Am.* 32(1):95-112, 1985.
192. Garbarino, J., "The Elusive 'Crime' of Emotional Abuse," *Child Abuse & Neglect* 2:89, 1978.
193. Garbarino, J., "Healing the Social Wounds of Isolation," *Child Abuse*, E.H. Newberger (ed.) (Boston, MA: Little, Brown & Co., 1982).
194. Garbarino, J., "Can We Measure Success in Preventing Child Abuse? Issues in Policy, Programming and Research," *Child Abuse & Neglect* 10:143-156, 1986.
195. Garbarino, J., and Crouter, A., "A Note on the Problems of Construct Validity in Assessing the Usefulness of Child Maltreatment Report Data," *Am. J. Public Health* 68:598, 1978.
196. Garbarino, J., and Crouter, A., "Defining the Community Context for Parent-Child Relations: The Correlates of Child Maltreatment," *Child Development* 49:604, 1978.
197. Garner, L. M., et al., *A Community Action Approach for Prevention of Burn Injuries* (Bethesda, MD: Public Health Service, U.S. Department of Health, Education, and Welfare, 1969).
198. Gaston, M. H., Verter, J. I., Woods, G., et al., "Prophylaxis With Oral Penicillin in Children With Sickle Cell Anemia," *N. Eng. J. Med.* 314(25):1593-1599, 1986.
199. Genes, R. J., "Violence in the Family: A Review of Research in the Seventies," *J. Marriage Fam.* 42:873, 1980, as cited in Hampton, in press.
200. George, C., and Main, M., "Social Interactions of Young Abused Children: Approach, Avoidance and Aggression," *Child Development* 50:306, 1979.
201. Gershenson, C. P., "1983 Trend of Children in Foster Care," Administration for Children, Youth, and Families, Office of Human Development Services, U.S. Department of Health and Human Services, mimeographed sheet, Washington, DC, April 1985.
202. Gibbens, T. C. M., "Violence in the Family," *Medico-Legal J.* 43:76, 1975.
203. Gil, D., *Violence Against Children* (Cambridge, MA: Harvard University Press, 1970).
204. Gilbert, J. R., Feldman, W., Seigal, L., et al., "How Many Well-Baby Visits Are Necessary in the First 2 Years of Life?" *Can. Med. Assoc. J.* 130:857-861, 1984.
205. Giovannoni, J. M., and Becerra, R. M., *Defining Child Abuse* (New York, NY: Free Press, 1979).
206. Giovannoni, J. M., and Billingsley, A., "Child Neglect Among the Poor: A Study of Parental Adequacy in Families of Three Ethnic Groups," *Child Welfare* 49:196, 1970.
207. Gitlin, J. D., Soil, R. F., Parad, R. B., et al., "A Randomized Controlled Trial of Exogenous Surfactant for the Treatment of Hyaline Membrane Disease" *Pediatric Research* 20:429A, 1986.
208. Goggin, M. L., *Policy Design and the Politics of Implementation: The Case of Child Health Care in the American States* (Knoxville, TN: University of Tennessee Press, 1987).
209. Gold, R. B., and Kenney, A. M., "Paying for Maternity Care," *Fare. Plan. Perspectives* 17(3):103-111, 1985.
210. Goldenberg, R., University of Alabama, Birmingham, AL, personal communication, June 1987.
211. Goldenberg, R. L., Humphrey, J. L., Hale, C. B., et al., "Neonatal Deaths in Alabama, 1970-1980: An Analysis of Birth Weight- and Race-Specific Neonatal Mortality Rates," *Am. J. Obstet. Gynecol.* 145(5):545-552, 1983.
212. Goldenberg, R. L., and Koski, J., *The Improved Pregnancy Outcome Project: An Analysis of the Impact of a Federal Program on Infant Mortality* (Birmingham, AL: Division of Maternal-Fetal Medicine, Department of Obstetrics and Gynecology, University of Alabama, no date).
213. Goldman, F., and Grossman, M., "The Impact of Public Health Policy: The Case of Community Health Centers," Working Paper No. 1020 (Cambridge, MA: National Bureau of Economic Research, November 1982).
214. Gordis, L., "Effectiveness of Comprehensive-Care Programs in Preventing Rheumatic Fever," *N. Eng. J. Med.* 289:331-335, 1973.
215. Gordis, L., and Markowitz, M., "Evaluation of the Effectiveness of Comprehensive and Continuous Pediatric Care," *Pediatrics* 48:766, 1971.
216. Gordon, S., Laboratories Administration, Maryland State Department of Health and Hygiene, Baltimore, MD, personal communication, 1986.

217. German, R. L., Charney, E., Holtzman, N. A., et al., "A Successful City-Wide Smoke Detector Giveaway Program," *Pediatrics* 75:14, 1985.
218. Gortmaker, S. L., "Poverty and Infant Mortality in the United States," *Am. Sociological Review* 44:280-297, April 1979.
219. Governor's Task Force To Study Adoption Procedures, "Growing Up Alone: Children Waiting for Families," State of Maryland, Annapolis, MD, January 1987.
220. Granoff, D. M., and Cates, K. L., "Haemophilus Influenzae Type b Polysaccharide Vaccines," *J. Pediatrics* 107(3):330-336, 1985.
221. Grant, W. W., Fearnow, R. G., Hebertson, L. M., et al., "Health Screening in School-Age Children," *Am. J. Dis. Child.* 125:520-522, 1973.
222. Gray, E. B., *The Final Report: Collaborative Research of Community and Minority Group Action To Prevent Child Abuse and Neglect, Vol. 1: Perinatal Intervention* (Chicago, IL: National Committee for the Prevention of Child Abuse, 1983).
223. Gray, E. B., and DiLeonardi, J., *Evaluating Child Abuse Prevention Programs* (Chicago, IL: National Committee for Prevention of Child Abuse, 1982).
224. Gray, J., "Community Health Centers and the Primary Care Block Grant," CRS paper 86-899 EPW, Congressional Research Service, U.S. Congress, Washington, DC, Mar. 21, 1986, updated Sept. 17, 1986.
225. Gray, J. D., Sutler, C. A., Dean, J. G., et al., "Prediction and Prevention of Child Abuse and Neglect," *J. Social Issues* 35(2):127-139, 1979.
226. Green, A. H., "A Psychodynamic Approach to the Study and Treatment of Child-Abusing Parents," *J. Am. Acad. Child Psych.* 15:414, 1976.
227. Green, M., "The New American Academy of Pediatrics Health—Supervision Guidelines: Implementation and Evaluation," *Well-Child Care*, E. Charney (ed.) (Columbus, OH: Ross Laboratories, 1986).
- 227a. Greenberg, R. S., "The Impact of Prenatal Care in Different Social Groups," *Am. J. Obstet. Gynecol.* 145:797, 1983.
228. Gregg, G. S., and Elmer, E., "Infant Injuries: Accident or Abuser?" *Pediatrics* 44:434, 1969.
229. Grossman, M., and Jacobowitz, S., "Variations in Infant Mortality Rates Among Counties of the United States: The Roles of Public Policies and Programs," *Demography* 18(4):695-713, 1981.
230. Gruber, K., and Jones, R., "Identifying Determinants of Risks of Sexual Victimization of Youth," *Child Abuse & Neglect* 7:17, 1983.
231. Guerin, D., and MacKinnon, D. P., "An Assessment of the California Child Passenger Restraint Requirement," *Am. J. Public Health* 75(2):142-144, 1985.
232. Gutelius, M. F., Kirsch, A. D., MacDonald, S., et al., "Controlled Study of Child Health Supervision: Behavioral Results," *Pediatrics* 60:294-304, 1977.
233. Guyer, B., "Title V: An Overview of Its Evolution and Future Role," paper presented at a conference on "Children in a Changing Health System: Assessments and Proposals for Reform," Harvard School of Public Health, Cambridge, MA, 1986.
234. Guyer, B., and Gallagher, S. S., "An Approach to the Epidemiology of Childhood Injuries," *Peal. Clin. North. Am.* 32(1):5-15, 1985.
235. Guyer, B., Talbot, A. M., and Pless, I. B., "Pedestrian Injuries to Children and Youth," *Peal. Clin. North. Am.* 32(1):163-174, 1985.
236. Guyer, B., Wallach, L., and Rosen, S., "Birth-Weight-Standardized Neonatal Mortality Rates and the Prevention of Low Birth Weight: How Does Massachusetts Compare With Sweden?" *N. Eng. J. Med.* 306(20):1230-1233, 1982.
237. Hack, M., and Fanaroff, A. A., "Changes in the Delivery Room Care of the Extremely Small Infant (<750 G): Effects on Morbidity and Outcome," *N. Eng. J. Med.* 314(10):660-664, 1986.
238. Haddon, W., Jr., "On the Escape of Tigers: An Ecologic Note," *Technology Review* 72:44, 1970.
239. Haddon, W., Jr., *To Prevent Harm* (Washington, DC: Insurance Institute for Highway Safety, 1978).
240. Haddon, W., Jr., "Advances in the Epidemiology of Injuries as a Basis for Public Policy," *Public Health Reports* 95:411, 1980.
241. Haddon, W., Jr., and Baker, S.P., "Injury Control," *Preventive and Community Medicine*, D. Clark and B. MacMahon (eds.) (Boston, MA: Little, Brown & Co., 1981).
242. Hadley, J., *More Medical Care, Better Health?* (Washington, DC: Urban Institute Press, 1982).
243. Hadley, J., *The Effects of Medical Care on Mortality and Morbidity: Selected Analyses With Secondary Data* (Washington, DC: Center for Health Policy Studies, Georgetown University, March 1987).
- 243a. Hadley, J., calculations based on the 1978, 1980, and 1982 National Health Interview Survey, 1987.

244. Haggerty, R. J., "The Rand Health Insurance Experiment for Children, Commentary," *Pediatrics* 76:969-971, 1985.
245. Haggerty, R. J., William T. Grant Foundation, New York, NY, personal communication, December 1986.
246. Haggerty, R. J., "Health Supervision Visits: Should the Immunization Schedule Drive the System?" commentaries, *Pediatrics* 79(4):581-582, 1987.
247. Haggerty, R. J., Roghmann, K. J., and Pless, I. B. (eds.). *Child Health and the Community* (New York, NY: John Wiley & Sons, 1975).
248. Hall, D., Chair, British Pediatric Association Working Party on Developmental Surveillance in Childhood, London, England, personal communication, February 1987.
249. Hall, M., and Chng, P., "Antenatal Care in practice," *Effectiveness and Satisfaction in Antenatal Care*, M. Enkin and I. Chalmers (eds.) (Philadelphia, PA: J. B. Lippincott Co., 1982).
250. Hall, M. H., Chng, P. K., and MacGillivray, I., "Is Routine Antenatal Care Worthwhile?" *Lancet* 2:78-80, 1980.
251. Halliday, H. L., McClure, G., Reid, M. McC., et al., "Controlled Trial of Artificial Surfactant To Prevent Respiratory Distress Syndrome," *Lancet* 1:476-478, 1984.
252. Hammond, K., Director of the Pediatric Microchemistry Laboratory, University of Colorado Health Sciences Center, Denver, CO, personal communication, 1986.
253. Hampton, R. L., "Race, Ethnicity, and Child Maltreatment: An Analysis of Cases Recognized and Reported by Hospitals," *The Black Family: Essays and Studies*, 3d ed., R. Staples (ed.) (Belmont, CA: Wadsworth Publishing Co., in press).
254. Hampton, R. L., and Newberger, E. H., "Child Abuse Incidence and Reporting by Hospitals: Significance of Severity, Class, Race," *Am. J. Public Health* 75:56, 1985.
255. Hanson, J., Department of Pediatrics, University of Iowa Hospitals and Clinics, Iowa City, IA, personal communication, 1986.
256. Hanson, J., Department of Pediatrics, University of Iowa Hospitals and Clinics, and Sullivan, M., University of Iowa Hygienic Laboratory, Iowa City, IA, personal communication, 1987.
257. Harris, J. E., "Prenatal Medical Care and Infant Mortality," *Economic Aspects of Health*, V. R. Fuchs (ed.) (Chicago, IL: University of Chicago Press, 1982).
258. Hart, S., and Brassard, M., "A Major Threat to Child Mental Health: Psychological Maltreatment," *Am. Psychologist* 42(2):160-165, 1987.
259. Hassemer, D., Chief, Clinical Chemistry, Wisconsin State Laboratory of Hygiene, Madison, WI, personal communication, 1986.
260. Hay, J. W., and Daum, R. S., "Cost Benefit Analysis of Two Strategies for Prevention of *Haemophilus Influenzae* Type b Infection," *Pediatrics* 80(3):319-330, 1987.
261. Hazzard, G., National Highway Traffic Safety Administration, U.S. Department of Transportation, Washington, DC, personal communication, July 1987.
262. Health Insurance Association of America, *The Cost of Having a Baby*, report of a survey by the Public Relations Division of HIAA (Washington, DC: 1982).
263. Health Insurance Association of America, *New Group Health Insurance* (Washington, DC: 1984).
264. Health Market Survey, 1987 *HMO Industry Membership Guide* (Washington, DC: 1987).
265. Heins, H. C., Miller, J. M., Sear, A., et al., "Benefits of a Statewide High-Risk Perinatal Program," *Obstet./Gynecol.* 62(3):294-296, 1983.
266. Held, P. J., and Holahan, J., "Containing Medicaid Costs in an Era of Growing Physician Supply," *Health Care Financing Review* 7(1):49-60, 1985.
267. Heifer, R. E., "A Review of the Literature on the Prevention of Child Abuse and Neglect," *Child Abuse & Neglect* 6:251-261, 1982.
268. Heppel, D., Division of Maternal and Child Health, Public Health Service, U.S. Department of Health and Human Services, Rockville, MD, personal communication, May 1987.
269. Herausgeber, Statistisches Bundesamt Wiesbaden, Verlag: W. Kohlhammer GMBH Stuttgart Und Mainz, Bevölkerung Und Erwerbstätigkeit, Reihe 1, Gebiet und Bevölkerung, 1983.
- 269a. Herceg-Baron, R., Ferstenberg, F., Shea, J., and Harris, K., "Supporting Teenagers' Use of Contraceptives: A Comparison of Clinic Services," *Family Planning Perspective* 18(2):61-66, 1986.
270. Herron, M. A., Katz, M., and Creasy, R. K., "Evaluation of a Preterm Birth Prevention Program: Preliminary Report," *Obstet./Gynecol.* 59:452-456, 1982.
271. Hewitt Associates, *Salaried Employee Benefits Provided by Major U.S. Employers: A Comparison Study, 1979 Through 1984* (Lincolnshire, IL: 1985).
- 271a. Hill, Ian, National Governors' Association,



- Washington, DC, personal communication, Dec. 21, 1987.
272. Hinman, A. R., and Koplan, J. P., "Pertussis and Pertussis Vaccine: Reanalysis of Benefits, Risks, and Costs," *J. A.M.A.* 251(23):3109-3113, 1984.
  273. Hiscock, W., Office of Medicaid Financial Management, Bureau of Quality Control, Health Care Financing Administration, U.S. Department of Health and Human Services, memorandum, Baltimore, MD, Feb. 9, 1987.
  274. Hoekelman, R. A., "What Constitutes Adequate Well-Baby Care," *Pediatrics* 55:313-325, 1975.
  275. Hoekelman, R. A., "Well Child Visits Revisited," *Am. J. Dis. Child.* 137:17-20, 1983.
  276. Hofman, L. F., Mahoney C. P., and Thuline H., "Congenital Adrenal Hyperplasia: Benefits of Screening for Early Diagnosis and Treatment," *Genetic Disease: Screening and Management*, T.P. Carter and A.M. Willey (eds.) (New York, NY: Alan R. Liss, Inc., 1986).
  277. Holahan, J., "Paying for Physician Services in State Medicaid Programs," *Health Care Financing Review* 5(3):99-110, 1984.
  278. Holahan, J. F., and Cohen, J. W., *Medicaid: The Trade-off Between Cost Containment and Access to Care* (Washington, DC: The Urban Institute Press, 1986).
  279. Holtzman, C., Slazyk, W. E., Cordero, J. F., et al., "Descriptive Epidemiology of Missed Cases of Phenylketonuria and Congenital Hypothyroidism," *Pediatrics* 78(4):553-558, 1986.
  280. Holtzman, N. A., "Newborn Screening for Hereditary Metabolic Disorders: Desirable Characteristics, Experience, and Issues," *Genetic Issues in Pediatric and Obstetric Practice*, M.M. Kaback (cd.) (Chicago, IL: Yearbook Medical Publishers, Inc., 1980).
  281. Holtzman, N. A., "Genetic Screening: Criteria and Evaluation—A Message for the Future," *Genetic Disease: Screening and Management*, T.P. Carter and A.M. Willey (eds.) (New York, NY: Alan R. Liss, Inc., 1986).
  282. Holtzman N. A., McCabe E. R. B., Cunningham G. C., et al., "Screening for Phenylketonuria" (letter), *N.Eng. J. Med.* 304(21):1300, 1981.
  283. Holtzman, N. A., Meek, A. G., and Mellits, E. D., "Neonatal Screening for Phenylketonuria, Part I: Effectiveness," *J.A.M.A.* 229(6):667-670, 1974.
  284. Homer, C. J., "Evaluation of the Evidence on the Effectiveness of Well Child Care Services for Children," prepared for the Office of Technology Assessment, U.S. Congress, Washington, DC, April 1987.
  285. Horbar, J. D., "A Multicenter Survey of 28 Day Survival and Supplemental Oxygen Administration in Infants 701-1500 Grams," paper presented at the Ross Laboratories Special Conference on Topics in Neonatology, Washington, DC, Dec. 7-9, 1986.
  286. Home, P., Division of Immunization, Centers for Disease Control, Public Health Service, U.S. Department of Health and Human Services, Atlanta, GA, personal communication, October 1986.
  287. Home, P., Division of Immunization, Centers for Disease Control, Public Health Service, U.S. Department of Health and Human Services, Atlanta, GA, personal communication, March 1987.
  288. Howe, H., "The Prospect for Children in the United States," *Phi Delta Kappan* 68:191-196, November 1986.
  289. Hoyt, L., American Academy of Family Physicians, Washington, DC, personal communication, March 1987.
  - 290< Hughey, M. J., "Routine Prenatal and Gynecologic Care in Prepaid Group Practice," *J. A.M.A.* 256(13):1775-1777, 1986.
  - 291< Hunter, I, S., and Kilstrom, N., "Breaking the Cycle in Abusive Families," *Am. J. Psych.* 136:1320, 1979.
  - 292 Hutton, N., and Starfield, B., "Iron Deficiency Anemia," *The Effectiveness of Medical Care: Validating Clinical Wisdom*, B. Starfield (cd.) (Baltimore, MD: Johns Hopkins University Press, 1985).
  293. Iams, J. D., Johnson, F. F., O'Shaughnessy, R. W., et al., "A Prospective Random Trial of Home Uterine Activity Monitoring in Pregnancies at Increased Risk of Preterm Labor," *Am. J. Obstet. Gynecol.* 157:638-643, 1987.
  294. Information Service Center, Inc., Baltimore, MD, unpublished data, prepared for the Office of Technology Assessment, U.S. Congress, Washington, DC, July 1986.
  295. Ingram, D. D., Makuc, D., and Kleinman, J. C., "National and State Trends in Use of Prenatal Care, 1970-83," *Am. J. Public Health* 76(4):417, 1986.
  296. Institute of Medicine, *Preventing Low Birth-weight* (Washington, DC: National Academy Press, 1985).
  297. InterStudy, 1986 June Update: A Mid-Year Report on HMO Growth (Excelsior, MN: June 1986).
  298. Irwin, P. H., and Conroy-Hughes, R., "EPSDT Impact on Health Status: Estimates Based on

- Secondary Analysis of Administratively Generated Data," *Medical Care* 20:216-234, 1982.
299. Jason, J., "Child Abuse in Georgia: A Method To Evaluate Risk Factors and Reporting Bias," *Am. J. Public Health* 72:1353, 1982.
  300. Jason, J., "Child Homicide Spectrum," *Am. J. Dis. Child.* 137:578-581, 1983.
  301. Jason, J., and Andereck, N. D., "Fatal Child Abuse in Georgia: The Epidemiology of Severe Physical Child Abuse," *Child Abuse & Neglect* 7:1-9, 1983.
  302. Jason, J., Carpenter, M., and Tyler, C., "Underrecording of Infant Homicide in the United States," *Am. J. Public Health* 73:195-197, 1983.
  303. Jekel, J. F., Currie, J. B., Klerman, L. V., et al., "An Analysis of Statistical Methods for Comparing Obstetric Outcomes: Infant Health in Three Samples of School-Age Pregnancies," *Am. J. Obstet. & Gynecol.* 112(1):9-19, 1972.
  304. Jobe, A., "Surfactant Treatment for Respiratory Distress Syndrome," *Respiratory Care* 31(6): 467-476, 1986.
  305. Johnson, D. K., and Hefferin, E. A., "Perinatal Outcomes Among High-Risk Patients in Two Prenatal Care Programs," *Inquiry* 14:293-302, 1977.
  306. Johnson, K., and Rosenbaum, S., *Building Health Programs for Teenagers*, a working paper by the Children's Defense Fund's Adolescent Pregnancy Prevention Project, Washington, DC, 1986.
  307. Joint Committee on Infant Hearing, "Position Statement 1982," *Pediatrics* 70:496-497, 1982.
  308. Jones, D. P. H., and McGraw, J. M., "Reliable and Fictitious Accounts of Sexual Abuse in Children," abstract of data first presented at the 7th National Conference on Child Abuse and Neglect, Chicago, IL, Nov. 12, 1985.
  309. Jones, J., Tiezzi, L., and Williams-Kaye, J., "Financial Access-Key to Early Prenatal Care," presented at the 113th Annual Meeting of the American Public Health Association, Washington, DC, Nov. 17-21, 1985.
  310. Jones, M., "Physician Participation in the Medical Program: Highlights of Findings From a 1977 Survey," *Socioeconomic Report*, Vol. 22, Issues 3 and 4 (San Francisco, CA: California Medical Association, 1977).
  311. Joyce, T., "The Impact of Induced Abortion on White and Black Birth Outcomes in the United States," *Demography* 24(2):229-244, 1987.
  312. Joyce, T., Corman, H., and Grossman, M., "A Cost-Effectiveness Analysis of Strategies To Reduce Infant Mortality," *Medical Care*, in press.
  313. Kakalik, J. S., Furry, W. S., Thomas, M. A., et al., *The Cost of Special Education* (Santa Monica, CA: Rand Corp., 1981).
  314. Kanthor, H. A., "Car Safety for Infants: Effectiveness of Prenatal Counseling," *Pediatrics* 58:320-322, 1976.
  315. Kaplan, R. S., Lave, L. B., and Leinhardt, S., "The Efficacy of a Comprehensive Health Care Project: An Empirical Analysis," *Am. J. Public Health* 62:924-930, 1972.
  316. Katz, M., and Gill, P. J., "Initial Evaluation of an Ambulatory System for Home Monitoring and Transmission of Uterine Activity Data," *Obstet. /Gynecol.* 66(2):273-277, 1985.
  317. Katz, M., Gill, P. J., and Newman, R. B., "Detection of Preterm Labor by Ambulatory Monitoring of Uterine Activity: A Preliminary Report," *Obstet. /Gynecol.* 68(6):773-778, 1986.
  318. Katz, M. H., Hampton, R. L., Newberger, E. H., et al., "Returning Children Home: Clinical Decision Making in Cases of Child Abuse and Neglect," *Am. J. Orthopsych.* 56(2):253-62, 1986.
  319. Kavanagh, C., "Emotional Abuse and Mental Injury," *J. Am. Acad. Child Psych.* 21:171, 1982.
  320. Keckley Market Research, *Sexual Abuse in Nashville: A Report on Incidence and Long-Term Effects* (Nashville, TN: 1983), as cited in Finkelhor and Araji, 1986.
  321. Keller, W., "Study of Selected Outcomes of the Early and Periodic Screening, Diagnosis, and Treatment Program in Michigan," *Public Health Reports* 98:110-119, 1983.
  322. Kempe, C. H., Silverman, F. N., Steele, B. F., et al., "The Battered Child Syndrome," *J.A.M.A.* 181:17-24, 1962.
  323. Kenney, A. M., Torres, A., Dittes, N., et al., "Medical Expenditures for Maternity and Newborn Care in America," *Family Planning Perspectives* 18(3):103-110, 1986.
  324. Kenney, M. L., "Assessment of CDC's Quality Assurance and Proficiency Testing in Newborn Screening," prepared for the Office of Technology Assessment, U.S. Congress, Washington, DC, November 1986.
  325. Kenney, M. L., "Description and Comparison of Four Neonatal Screening Programs in the United States," prepared for the Office of Technology Assessment, U.S. Congress, Washington, DC, December 1986.
  326. Kercher, G., and McShane, M., "The Prevalence of Child Sexual Abuse Victimization in an Adult Sample of Texas Residents," *Child Abuse & Neglect* 8:495, 1984.

327. Kessner, D., and Kalk, L., *A Strategy for Evaluating Health Services* (Washington, DC: National Academy Press, 1973).
328. Kessner, D., Singer, J., Kalk, C., et al., "Infant Death: An Analysis by Maternal Risk and Health Care," *Contrasts in Health Status: Vol. I* (Washington, DC: Institute of Medicine, National Academy of Sciences, 1973).
329. Kessner, D. M., Snow, C. K., and Singer, J., *Assessment of Medical Care for Children* (Washington, DC: National Academy of Sciences, 1974).
330. Kilbride, H., St. Luke's Hospital, Kansas City, MO, personal communication, Nov. 5, 1987.
331. Kim, I., Pollitt, E., Leibel, R. L., et al., "Application of Receiver-Operator Analysis to Diagnostic Tests of Iron Deficiency in Man," *Pediatric Research* 18:916-920, 1984.
332. King, J. F., Keirse, M. J., Grant, A., et al., "Tocolysis—the Case for and Against," in *Preterm Labour and Its Consequences*, R.W. Beard, and F. Sharp, (eds.) (London, England: Royal College of Obstetricians and Gynaecologists, 1985).
333. Kirby, D., "St. Paul Maternal and Infant Care Sexuality Education and Clinic Program," *Sexuality Education: An Evaluation of Programs and Their Effects* (Santa Cruz, CA: Network Publications, 1984).
- 333a. Kirby, D., Center for Population Options, Washington, DC, personal communication, May 4, 1987.
334. Kirchner, hi., "Are Fees Breaking All Restraints?" *Medical Economics*, Oct. 6, 1986.
335. Klaus, M. H., and Kennell, J. H., *Maternal Infant Bonding* (St. Louis, MO: C.V. Mosby Co., 1976).
336. Klein, M., Roghmann, K., Woodward, K., et al., "The Impact of the Rochester Neighborhood Health Center on Hospitalization of Children, 1968 to 1970," *Pediatrics* 51:833-839, 1973.
337. Kleinman, J. C., National Center for Health Statistics, Public Health Service, U.S. Department of Health and Human Services, Hyattsville, MD, unpublished memorandum, Dec. 12, 1985.
338. Kleinman, J. C., National Center for Health Statistics, Public Health Service, U.S. Department of Health and Human Services, "Current Estimates From the National Health Interview Survey, U.S. 1985," *Vital and Health Statistics, Series 10*, No. 160, Hyattsville, MD, 1986.
339. Kleinman, J. C., National Center for Health Statistics, Public Health Service, U.S. Department of Health and Human Services, Hyattsville, MD, unpublished data from the U.S. vital statistics, personal communication, 1986.
340. Kleinman, J. C., Kovar, M. G., Feldman, J. J., et al., "A Comparison of 1960 and 1973-1974 Early Neonatal Mortality Rates," *Am. J. Epidemiology* 108:454-469, 1983.
341. Klerman, L., and Burst, H. V., "Evidence of the Effectiveness of Recommended Antepartum Care Components, Task I," prepared for the Office of Technology Assessment, U.S. Congress, Washington, DC, October 1986.
342. Klerman, L., and Burst, H. V., "Evidence of the Effectiveness of Recommended Antepartum Care Components, Task II," prepared for the Office of Technology Assessment, U.S. Congress, Washington, DC, March 1987.
343. Kletke, P. R., Davidson, S. M., Perloff, J. D., et al., "The Extent of Physician Participation in Medicaid: A Comparison of Physician Estimates and Aggregated Patient Records," *Health Services Research* 20(5):503-523, 1985.
344. Kline, J., O'Sullivan, J., and Cislawski, J. A., "Medicare, Medicaid, and Maternal and Child Health Programs: An Overview of Major Legislation Enacted From 1980 Through 1986," background paper, Congressional Research Service, U.S. Congress, Washington, DC, January 1987.
345. Koch, R., Department of Clinical Pediatrics, University of Southern California School of Medicine, Los Angeles, CA, personal communication, May 1987.
346. Koch, R., Friedman, E. G., Wenz, E., et al., "The Maternal PKU Collaborative Study," *Inher. Metab. Dis.* 9(suppl. 2):159-168, 1986.
347. Kohler, L., "Physical Mass Examinations in the School Health Service," *Acta Paediatr. Scand.* 66:307-310, 1977.
348. Kohler, L., and Hoist, H. E., "Auditory Screening of Four-Year Old Children," *Acta Paediatr. Scand.* 61:555-60, 1972.
349. Konishi, M., Fujiwara, T., Naito, T., et al., "Surfactant Replacement Therapy in Neonatal Respiratory Distress Syndrome (RDS)—A Prospective Collaborative Study," paper presented at the XVIII International Congress of Pediatrics, Honolulu, HI, July 7, 1986.
350. Koplan, J. P., and Preblud, S. R., "A Benefit-Cost Analysis of Mumps Vaccine," *Am. J. Dis. Child.* 136:362-364, 1982.
351. Koplan, J. P., Schoenbaum, S. C., Weinstein, M. C., et al., "Pertussis Vaccine: An Analysis of Benefits, Risks, and Costs," *N. Eng. J. Med.* 301(17):906-911, 1979.

352. Korenbrot, C. C., "Risk Reduction in Pregnancies of Low-Income Women," *Mobius* 43:35-43, July 1984.
353. Korsch, B. M., "Issues in Evaluating Child Health Supervision," *J. Pediatrics* 75:942-951, 1985.
354. Kovar, M. G., *Indicators for Monitoring Child Health Outcomes: The American Perspective—National Data*, Working Paper Series No. 18 (Hyattsville, MD: National Center for Health Statistics, U.S. Department of Health and Human Services, November 1983).
355. Kravitz, H., "Prevention of Accidental Falls in Infancy by Counseling Mothers," *Illinois Med. J.* 144:570, 1973.
356. Krugman, R. D., Lenherr, M., Betz, L., et al., "The Relationship Between Unemployment and Physical Abuse of Children," *Child Abuse & Neglect* 10:415-418, 1986.
357. Kurucz, C. N., "An Analysis of the Injury Reduction Capabilities of Breakaway Light Standards and Various Guard Rails," *Accident Analysis and Prevention* 16:105, 1984.
358. LaForce, F. M., "U.S. Preventive Services Task Force: Immunizations, Immunoprophylaxis, and Chimoprophylaxis To Prevent Selected Infections," *J. A.M.A.* 257(18):2464-2470, 1987.
359. LaFranchi, S. H., Hanna, C. E., Krainz, P. L., et al., "Screening for Congenital Hypothyroidism With Specimen Collection at Two Time Periods: Results of the Northwest Regional Screening Program," *Pediatrics* 76(5):734-740, 1985.
360. LaFranchi, S. H., Murphey, W. H., Foley, T. P., et al., "Neonatal Hypothyroidism Detected by the Northwest Regional Screening Program," *Pediatrics* 63:180-191, 1979.
361. Lakin, K. C., Center for Residential and Community Services, University of Minnesota, Minneapolis, MN, personal communication, May 1987.
362. Lakin, K. C., Hill, B. K., Street, H., et al., "Persons With Mental Retardation in State-Operated Residential Facilities: Years Ending June 30, 1984 and June 30, 1985 With Longitudinal Trends From 1950 to 1985," Department of Educational Psychology, University of Minnesota, Minneapolis, MN, 1986.
363. Lanson, P., "Efficacy of Prenatal and Postpartum Home Visits on Child Health and Development," *Pediatrics* 66:191-197, 1980.
364. Last, J. M., "Scope and Methods of Prevention," *Public Health and Preventive Medicine*, 12th ed., J. Last (cd.) (Norwalk, CT: Appleton Century Crofts, 1986).
365. Lauderdale, M., Valiunas, A., and Anderson, R., "Race, Ethnicity and Child Maltreatment: An Empirical Analysis," *Child Abuse & Neglect* 4(3):163-169, 1980.
366. Laudicina, S. S., *A Comparative Survey of Medicaid Hospital Reimbursement Systems for Inpatient Services, State by State, 1980-1985* (Washington, DC: Urban Institute, 1986).
367. Lauve, R. F., Associate Director, Human Resources Division, statement before the Subcommittee on Select Education and Labor, U.S. House of Representatives, U.S. Congress, Washington, DC, Dec. 2, 1980.
368. Layde, P. M., Von Allmen, S. D., and Oakley, G.P. Jr., "Congenital Hypothyroidism Control Programs: A Cost-Benefit Analysis," *J.A.M.A.* 241(21):2290-2292, 1979.
369. Lazar, P., Gueguen, S., Dreyfus, J., et al., "Multicentered Controlled Trial of Cervical Cerclage in Women at Moderate Risk of Preterm Delivery," *Br. J. Obstet. Gynaecol.* 91:731-735, 1984.
370. Leibowitz, A., Manning, W. G., Keeler, E. B., et al., "Effect of Cost-Sharing on the Use of Medical Services by Children: Interim Results From a Randomized Controlled Trial," *Pediatrics* 75(5):942-951, 1985.
371. Lenke, R. R., and Levy, H. L., "Maternal Phenylketonuria and Hyperphenylalaninemia: An International Survey of the Outcome of Untreated and Treated Pregnancies," *N. Eng. J. Med.* 303(21):1202-1208, 1980.
372. Leppert, P. C., and Namerow, P. B., "Costs Averted by Providing Comprehensive Prenatal Care to Teenagers," *J. Nurse-Midwifery* 30(5):285-289, 1985.
373. Leppert, P. C., Namerow, P. B., and Barker, D., "Pregnancy Outcomes Among Adolescent and Older Women Receiving Comprehensive Prenatal Care," *J. Adol. Health Care* 7(2):112-117, 1986.
374. Leveno, K., Cunningham, G., Roark, M., et al., "Prenatal Care and the Low Birth Weight Infant," *Obstet. Gynecol.* 66(5):599-605, 1985.
375. Leventhal, J. M., "Risk Factors for Child Abuse: Methodologic Standards in Case-Control Studies," *Pediatrics* 68:684, 1981.
376. Levine, G. D., and Therrell, B. L., "Second Testing for Hypothyroidism," *Pediatrics* 78(2):375-376, 1986.
377. Levy, H. L., Meryash, D. L., and Guthrie, R., reply to "Screening for Phenylketonuria," *N. Eng. J. Med.* 304(21):1300-1301, 1981.

378. Levy, H. L., and Mitchell, M. L., "The Current Status of Newborn Screening," *Hospital Practice* 17(7):88-97, 1982.
379. Lewis, C., "What Is the Evidence?" *Am. J. Dis. Child.* 122:469-474, 1971.
- 379a. Lewis, D. O., Shanok, S. S., Pincus, J. H., et al., "Violent Juvenile Delinquents: Psychiatric, Neurological, Psychological and Abuse Factors," *J. Am. Acad. Child Psych.* 18:307, 1979.
380. Lewit, E., "The Demand for Prenatal Care and the Production of Healthy Infants," *Research in Human Capital and Development* 3:127-181, 1983.
381. Light, R., "Abused and Neglected Children in America: The Study of Alternative Policies," *Harvard Educ. Rev.* 43:556, 1973.
382. Littman, M., Bureau of the Census, U.S. Department of Commerce, Suitland, MD, personal communication, August 1987.
383. Lohr, K. N., Brook, R. H., Kamberg, C. J., et al., *Use of Medical Care in the Rand Health Insurance Experiment* (Santa Monica, CA: Rand Corp., December 1986).
384. Long, S. H., Settle, R. F., and Stuart, B. C., "Reimbursement and Access to Physician Services Under Medicare," *J. Health Economics* 5:235-251, 1986.
385. Lovick, S., and Wesson, W. F., *School-Based Clinics: Update 1986*, Center for Population Options, Washington, DC, August 1986.
- 385a. Lovick, S., *School-Based Clinics: Update 1987*, Center for Population Options, Washington, DC, November 1987.
386. Lozoff, B., Brittenham, G. M., Viteri, F. E., et al., "The Effects of Short-Term Oral Iron Therapy on Developmental Deficits in Iron-Deficient Anemic Infants," *J. Pediatrics* 100:351-357, 1982.
387. Lozoff, B., Brittenham, G. M., Viteri, F. E., et al., "Developmental Deficits in Iron-Deficient Infants: Effects of Age and Severity of Iron Lack," *J. Pediatrics* 101:948-951, 1982.
388. Lozoff, B., Brittenham, G. M., Wolf, A. W., et al., "Iron Deficiency Anemia and Iron Therapy Effects on Infant Developmental Test Performance," *Pediatrics* 79:981-995, 1987.
389. Lurie, N., Manning, W., Peterson, C., et al., "Preventive Care: Do We Practice What We Preach?" *Am. J. Public Health* 77(7):801-804, 1987.
390. Lutzker, J. R., Frame, R., and Rice, J., "Project 12 Ways: An Ecobehavioral Approach to the Treatment and Prevention of Child Abuse and Neglect," *Education & Treatment of Children* 5:141-155, 1982.
391. Lutzker, J. R., and Rice, J. M., "Project 12-Ways: Measuring Outcome of a Large In-Home Service for Treatment and Prevention of Child Abuse and Neglect," *Child Abuse & Neglect* 8:519-524, 1984.
392. MacCready, R. A., and Levy, H. L., "The Problem of Maternal Phenylketonuria," *Am. J. Obstet. Gynecol.* 113:121-128, 1972.
393. Macfarlane, A., Vice Chair, British Pediatric Association Working Party on Developmental Surveillance in Childhood, Oxford, England, personal communication, February 1987.
394. Magee, E., Deputy Associate Bureau Director, Division of Maternal and Child Health, Health Services and Resources Administration, U.S. Department of Health and Human Services, Rockville, MD, personal communication, September 1987.
395. Magee, E., and Pratt, M., 1935-1985: *50 Years of U.S. Federal Support To Promote the Health of Mothers, Children and Handicapped Children in America*, Division of Maternal and Child Health, Bureau of Health Care Delivery and Assistance, Health Resources and Services Administration, Public Health Service U.S. Department of Health and Human Services (Vienna, VA: Information Sciences Research Institute, October 1985).
396. Mailick, M. D., "Families At Risk: A Public Health Social Work Perspective," keynote address at the proceedings of the workshop "Families at Risk: A Public Health Social Work Perspective," sponsored by the University of Pittsburgh, and the Division of Maternal and Child Health, U.S. Department of Health and Human Services, Pittsburgh, PA, Mar. 24-27, 1985.
397. Main, D. M., Katz, M., Chiu, G., et al., "Intermittent Weekly Contraction Monitoring To Predict Preterm Labor in Low Risk Women: A Blinded Study," abstract, paper presented at the annual meeting of the Society for Perinatal Obstetricians, Lake Buena Vista, FL, Feb. 5-7, 1987.
398. Main, T., "The Homeless Families of New York," *Public Interest* 85:3-21, 1986.
399. Malitz, D., "A Cost-Benefit Analysis of Extending Medicaid Coverage To Provide Prenatal Care to Pregnant Women," study submitted to the Texas Department of Human Resources, Austin, TX, May 1983.
400. Mandel, E. M., Rockette, H. E., Bluestone, C. D., et al., "Efficacy of Amoxicillin With and Without Decongestant-Antihistamine for Otitis Media With Effusion in Children," *N. Eng. J. Med.*

- 316:432-7, 1987.
401. Manning, W. L., "The EPSDT Program: A Progress Report," *Indiana Medicine* 78(4):320-322, 1985.
  402. Marchessault, J. H. V., Canadian Pediatric Society, Ottawa, ON, personal communication, February 1987.
  403. Marlow, N., D'Souza, S. W., and Chiswick, M. L., "Neurodevelopmental Outcome in Babies Weighing Less Than 2001 g at Birth," *Br. Med. J.* 294:1582-86, 1987.
  404. Massachusetts Department of Health, "Report on the Measles, Mumps, and Rubella Immunization Programs," Boston, MA, March 1980.
  405. Matlin, N. M., "Insuring for Preventive Care of the Total Family," *Business and Health*, p. 12, September 1985.
  406. McAllister, B., "Formula for Product Safety Raises Questions About Human Factor," *Washington Post*, p. A19, May 26, 1987.
  407. McAllister, B., "Consumer Safety Chief's Day of Ordeal," *Washington Post*, p. A25, June 5, 1987.
  408. McAnarney, E. R., Roghmann, K. J., Adams, B. N., et al., "Obstetric, Neonatal and Psychosocial Outcomes of Pregnant Adolescents," *Pediatrics* 61(2):199-205, 1978.
  409. McCabe, E. R. B., McCabe, L., Mosher, G. A., et al., "Newborn Screening for Phenylketonuria: Predictive Validity as a Function of Age," *Pediatrics* 72(3):390-398, 1983.
  410. McCord, J., "A Forty-Year Perspective of the Effects of Child Abuse and Neglect," *Child Abuse & Neglect* 7:265, 1983.
  411. McCormick, M. C., Shapiro, S., and Starfield, B. H., "Rehospitalization in the First Year of Life for High Risk Survivors," *Pediatrics* 66:991-999, 1980.
  412. McCormick, M. C., Shapiro, S., and Starfield, B. H., "The Regionalization of Perinatal Service: Summary of the Evaluation of a National Demonstration Program," *J. A. M. A.* 253(6):799-804, 1985.
  413. McDevitt, R., Buczko, W., Mauskopf, J., et al., "Medicaid Program Characteristics: Effects on Health Care Expenditures and Utilization," *Health Care Financing Review* 7(2):1-29, 1985.
  414. McDonald, A., U.S. Consumer Product Safety Commission, Washington DC, personal communication, 1987.
  415. McLaughlin, E., Marchone, M., Hanger, L., et al., "Smoke Detector Legislation: Its Effect on Owner Occupied Homes," *Am. J. Public Health* 75(8):858-862, 1985.
  416. McLoughlin, E., Vince, C. J., Lee, A. M., et al., "Project Burn Prevention: Outcome and Implications," *Am. J. Public Health* 72(3):241-247, 1982.
  417. McManus, P., "Catastrophic Childhood Illness: A Briefing Report," draft prepared for the American Academy of Pediatrics, Washington, DC, no date.
  418. McMenamin, P. D., "Medicaid Participation by Pediatricians and Obstetricians," prepared for the Office of Technology Assessment, U.S. Congress, Washington, DC, January 1987.
  419. McNeil, J., Bureau of the Census, U.S. Department of Commerce, Washington, DC, personal communication, June 1987.
  420. Medicare and Medicaid Guide "Omnibus Budget Reconciliation Act of 1986," *Medicare and Medicaid Guide*, No. 505 (Chicago, IL: Commerce Clearing House, Inc., Nov. 4, 1986).
  421. Melnick, B., and Hurley, J., "Distinctive Attributes of Child-Abusing Mothers," *J. Consult. Clin. Psych.* 33:746, 1969.
  422. Merritt, T. A., Hallman, M., Bloom, B. T., et al., "Prophylactic Treatment of Very Premature Infants With Human Surfactant," *N. Eng. J. Med.* 315(13):785-790, 1986.
  423. Meryash, D. L., Levy, H. L., Guthrie, R., et al., "Prospective Study of Early Neonatal Screening for Phenylketonuria," *N. Eng. J. Med.* 304(5):294-296, 1981.
  424. Micik, S., and Milette, M., "Injury Prevention in the Community: A Systems Approach," *Peel. Clin. North Am.* 32(1):251-165, 1985.
  425. Miller, C. A., "Infant Mortality in the U.S.," *Scientific American* 253(1):31-37, 1985.
  426. Miller, C. A., Fine, A., Adams-Taylor, S., et al., *Monitoring Children's Health: Key Indicators* (Washington, DC: American Public Health Association, 1986).
  427. Miller, D., and Challas, G., "Abused Children as Adult Parents: A Twenty-Five Year Longitudinal Study," presented at the National Conference for Family Violence Researchers, Durham, NC, July 1981.
  428. Miller, J. R., and Pless, I. B., "Child Automobile Restraints: Evaluation of Health Education," *Pediatrics* 59:907-911, 1977.
  429. Miller, R. E., Reisinger, K. S., Blatter, M. M., et al., "Pediatric Counseling and Subsequent Use of Smoke Detectors," *Am. J. Public Health* 72(4):392, 1982.
  430. Mitchell, J., "Health Care Financing Administration/National Opinion Research Corporation, Physician Practice Costs and Income Survey: 1984-85, '1 unpublished data, Center for Health Economics Research, Chestnut Hill, MA,

- 1986.
431. Mitchell, J. B., and Schurman, R., "Access to Private Obstetrics Gynecology Services Under Medicaid," *Medical Care* 22(11): 1026-1037, 1984.
  432. Moore, G., and Frank, K., "Comprehensive Health Services for Children: An Exploratory Study of Benefit," *Pediatrics* 1:17-21, 1973.
  433. Moore, T. R., Origel, W., Key, T. C., et al., "The Perinatal and Economic Impact of Prenatal Care in a Low-Socioeconomic Population," *Am. J. Obstet. Gynecol.* 154(1):29-33, 1986.
  434. Morrison, J. C., "Prevention of Preterm Birth by Ambulatory Assessment of Uterine Activity: A Randomized Study," *Am. J. Obstet. Gynecol.* 156: 536-543, 1987.
  435. Mosher, M. D., and Bachrach, C. A., National Center for Health Statistics, Public Health Service, U.S. Department of Health and Human Services, "Contraceptive Use, United States, 1980," *Vital and Health Statistics, Series 23, No. 12*, DHHS Pub. No. (PHS) 86-1988 (Washington, DC: U.S. Government Printing Office, September 1986).
  436. Mosher, W. D., and Horn, M. C., "Source of Service and Visit Rate of Family Planning Services: United States, 1982," *Public Health Reports* 101(4):405-416, 1986.
  437. Mudd, S. H., Levy, H. L., and Skovby, F., "Disorders of Transsulfuration," *The Metabolic Basis for Inherited Disease*, C. R. Scriver, A. L. Beaudet, W. S. Sly, et al. (eds.) (New York, NY: McGraw-Hill, in press).
  438. Myers, L. P., Eisenberg, J. M., and Pauly, M. V., "Physicians' Payment and Their Prescription of Laboratory Tests: The Effects on Clinical Laboratory Services of Selected Alternatives for Paying Physicians Under the Medicare Program," prepared for the Office of Technology Assessment, U.S. Congress, Washington, DC, September 1985.
  439. Nader, P., "Frequency and Nature of School Problems," *Child Health and the Community*, R.J. Haggerty, K.J. Roughman, and I.B. Pless (eds.) (New York, NY: John Wiley & Sons, 1975).
  440. Nader, P., Roy, L., and Briak, S., "The New Morbidity: Use of School and Community Health Care Resources for Behavioral, Educational and Social Family Problems," *Pediatrics* 67:53-59, 1981.
  441. Nageotte, M. P., Dorchester, W., Porto, M., et al., "Quantitation of Uterine Activity Preceding Preterm, Term and Postterm Labor," abstract, paper presented at the annual meeting of the Society for Perinatal Obstetricians, Lake Buena Vista, FL, Feb. 5-7, 1987.
  442. National Academy of Sciences, *Genetic Screening: Programs, Principles, and Research* (Washington, DC: 1975).
  443. National Academy of Sciences, *Risking the Future: Adolescent Sexuality, Pregnancy, and Childbearing* (Washington, DC: National Academy Press, 1987).
  444. National Academy of Sciences, Committee for the Study of the Benefits and Costs of the 55 mph National Maximum Speed Limit, "55: A Decade of Experience," *Transportation Research Board Special Report No. 204* (Washington, DC: National Academy Press, 1984).
  445. National Advisory Committee on Immunization, *A Guide to Immunization for Canadians* (Ottawa, ON: Ministry of Supply and Services, 1984).
  446. National Advisory Committee on Immunization, "Statement on Haemophilus b Polysaccharide Vaccine," *Canada Diseases Weekly Report* 12(9):33-34, 1986.
  447. National Association of Children's Hospitals and Related Institutions, Inc., *Children Hospitals Case Mix Classification System Project Phase III Report Executive Summary* (Alexandria, VA: September 1986).
  448. National Committee for Prevention of Child Abuse, "Deaths Due to Maltreatment Soar: The Results of the Eighth Semi-Annual Fifty State Survey," Chicago, IL, March 1987.
  449. National Indian Health Board, "President's '88 IHS Budget Finds Little Support in Congress," *NIHB Reporter* 4(6):12-14, 1987.
  450. National Perinatal Information Center, unpublished data from the American Hospital Association's 1983 Annual Survey of Hospitals, Providence, RI, December 1986.
  451. National Research Council and Institute of Medicine, *Injury in America* (Washington, DC: National Academy Press, 1985).
  452. National Safety Council, *Accident Facts* (Chicago, IL: all editions, 1984).
  453. Naylor, E. W., "Recent Developments in Neonatal Screening," *Semin. Perinatol. Q*(3):232-249, 1985.
  454. Naylor, E. W., "Screening for PKU Cofactor Variants," *Genetic Disease: Screening and Management*, T.P. Carter and A.M. Willey (eds.) (New York, NY: Alan R. Liss, Inc., 1986).
  455. Naylor, E. W., and Guthrie, R., "Newborn Screening for Maple Syrup Urine Disease (Branched-Chain Ketoaciduria)," *Pediatrics* 61:262-266, 1978.

456. Nelson, K. B., and Ellenberg, J. H., "Predictors of Low and Very Low Birth Weight and the Relation of These to Cerebral Palsy," *J. A.M.A.* 254(11):1473-1479, 1985.
457. New York Times, "A System Overloaded: The Foster-Care Crisis," *New York Times*, p. 1, Mar. 15, 1987.
458. Newacheck, P. W., and Half on, N., "Access to Ambulatory Care Services for Economically Disadvantaged Children," *Pediatrics* 78(5):813-819, 1986.
459. Newberger, E. H., "Child Abuse," prepared for the Surgeon General's Workshop on Violence and Public Health, Leesburg, VA, October 1985.
460. Newman, R. B., Gill, P. J., Wittreich, P., and Katz, M., "Maternal Perception of Prelabor Uterine Activity," *Obstet./Gynecol.* 68:765-769, 1986.
461. Nightingale, E. O., and Meister, S.B.(eds.), *Prenatal Screening, Policies, and Values: The Example of Neural Tube Defects*, report of the Working Groups on Early Life and Adolescent Health Policy and of Health Promotion and Disease Prevention, Division of Health Policy Research and Education, Harvard University, Cambridge, MA, 1987.
462. Nordhaus, W., "Comments of William Nordhaus on Notice of Proposed Rulemaking on Federal Motor Vehicle Safety Standards: Occupant Crash Protection," docket no. 74-14, notice 22, Washington, DC, Department of Transportation, May 26, 1981, as cited in Warner, 1982.
- 462a. Norris, F., and Williams, R., "Perinatal Outcomes Among Medicaid Recipients in California," *Am. J. Public Health* 74(10):1112-1117, 1984.
463. Northern, J., "Impedance Audiometry," *Hearing Disorders*, J. Northern (cd.) (Boston, MA: Little Brown & Co., 1984).
464. O'Connell, E. J., and Friesen, C. D., "The Pre-school Physical Examination," *Clinical Pediatrics* 15:930-931, 1976.
465. O'Sullivan, J., *Medicaid: FY '87 Budget*, Issue Brief, Education and Public Welfare Division, Congressional Research Service, U.S. Congress, Washington, DC, Aug. 18, 1986.
466. O'Toole, R., Turbett, P., and Nalepka, C., "Theories, Professional Knowledge and Diagnosis of Child Abuse," *The Dark Side of Families: Current Family Violence Research*, D. Finkelhor, R.J. Genes, G.T. Hotaling, et al. (eds.) (Beverly Hills, CA: Sage Publications, 1983).
467. Oates, R. K., Davis, A. A., Ryan, M. G., et al., "Risk Factors Associated With Child Abuse," *Child Abuse & Neglect* 3(2):547-553, 1979.
468. Olds, D., University of Rochester Medical Center, Rochester, NY, personal communication, 1986, as cited in Dubowitz, 1986.
469. Olds, D., Henderson, C., Tatelbaum, R., et al., "Improving the Delivery of Prenatal Care and Outcomes of Pregnancy: A Randomized Trial of Nurse Home Visitation," *Pediatrics* 77(1):16-28, 1986.
470. Olds, D. L., and Henderson, C. R., "The Prevention of Maltreatment," in *Child Maltreatment: Research and Theory on the Consequences of Child Abuse and Neglect*, D. Cicchetti and V. Carlson (eds.) (Cambridge, MA: Cambridge University Press, in press).
471. Olds, D. L., Henderson, C. R., Chamberlain, R., et al., "Preventing Child Abuse and Neglect: A Randomized Trial of Nurse Home Visitation," *Pediatrics* 78(1):65-78, 1986.
472. Orenstein, D. M., Boat, T. F., Stern, R. C., et al., "The Effect of Early Diagnosis and Treatment in Cystic Fibrosis," *Am. J. Dis. Child.* 131:973, 1977.
473. Orr, M., and Forrest, J., "The Availability of Reproductive Health Services From Private Physicians," *Fare. Plan. Perspectives* 17(2):63-69, 1985.
474. Oski, F. A., and Honig, A. S., "The Effects of Iron Therapy on the Developmental Scores of Iron-Deficient Infants," *J. Pediatrics* 92:21-25, 1978.
475. Oski, F.A., Honig, A. S., Helu, B., et al., "Effect of Iron Therapy on Behavior Performance in Nonanemic, Iron-Deficient Infants," *Pediatrics* 71:877-880, 1983.
476. Packman, S., "Neurological Sequelae in Galactosemics," Sixth International Neonatal Screening Symposium, Austin, TX, November 1986.
477. Papiernik, E., Bouyer, J., Dreyfus, J., et al., "Prevention of Preterm Births: A Perinatal Study in Haguenau, France," *Pediatrics* 76(2):154-158, 1985.
478. Paradise, J. L., "Otitis Media During Early Life: How Hazardous to Development? A Critical Review of the Evidence," *Pediatrics* 68:869-73, 1981.
479. Parsons, P. E., Liechtenstein, R., Berke, S. E., et al., "Costs of Illness, United States, 1980," *National Medical Care Utilization and Expenditure Survey*, National Center for Health Statistics, Public Health Service, U.S. Department of Health and Human Services, Series, C, Analytical Report No. 3, DHHS Pub. No. 86-20403



- (Washington, DC: U.S. Government Printing Office, April 1986).
480. Pearn, J., Brown, J., and Hsia, E. Y., "Swimming Pool Drownings and Near-Drownings Involving Children: A Total Population Study From Hawaii," *Military Medicine* 145:15, 1980.
  481. Pease, K., and Preston, B., "Road Safety Education for Young Children," *Brit. J. Ed. Psych.* 37:305, 1967.
  482. Peltola, H., Kayhty, H., Sivonen, A., et al., "Haemophilus Influenza Type b Capsular Polysaccharide Vaccine in Children: A Double-Blind Field Study of 100,000 Vaccinees 3 Months to 5 Years of Age in Finland," *Pediatrics* 60(5):730-737, 1977.
  483. Peltola, H., Kayhty, H., Virtanen, M., et al., "Prevention of Haemophilus Influenzae b Bacteremic Infections With the Capsular Polysaccharide Vaccine," *N. Eng. J. Med.* 310(24):1561-1566, 1984.
  484. Pelton, L. H., "Child Abuse and Neglect: The Myth of Classlessness," *Am. J. Orthopsych.* 48:608, 1978.
  485. Pennington, B. F., Van Doorninck, W. J., McCabe, L. L., et al., "Neuropsychological Deficits in Early Treated Phenylketonuric Children," *Amer. J. Merit. Defic.* 89(5):467-474, 1985.
  486. Peoples, M. D., Grimson, R. C., and Daughtry, G. L., "Evaluation of the Effects of the North Carolina Improved Pregnancy Outcome Project: Implications for State-Level Decision-Making," *Am. J. Public Health* 74(6):549-554, 1984.
  487. Peoples, M. D., and Siegel, E., "Measuring the Impact of Programs for Mothers and Infants on Prenatal Care and Low Birth Weight: The Value of Refined Analyses," *Medical Care* 21(6):586-605, 1983.
  488. Perelman, R. H., and Farrell, P. M., "Analysis of Causes of Neonatal Death in the United States With Specific Emphasis on Fatal Hyaline Membrane Disease," *Pediatrics* 70:570-575, 1982.
  489. Perloff, J. D., Kletke, P. R., and Neckerman, K. M., "Trends in Pediatrician Participation in State Medicaid Programs," *Medical Care* 24(8):749-760, 1986.
  490. Peters, S. D., "The Relationship Between Childhood Sexual Victimization and Adult Depression Among Afro-American and White women," Unpublished doctoral dissertation, as cited in Finkelhor and Araji, 1986.
  491. Petschek, M., and Adams-Taylor, S., *Prenatal Care Initiatives: Moving Toward Universal Prenatal Care in the United States—Final Report*, Center for Population and Family Health, Columbia University and Child Health Outcomes Project, University of North Carolina, Chapel Hill, NC, September 1986.
  492. Pettigrew, A. G., Edwards D. A., and Henderson-Smart, D. J., "Screening for Auditory Dysfunction in High-Risk Neonates," *Early Human Develop.* 14:109-20, 1986.
  493. Phelps, D., Maryland Hospital Cost Review Commission, Baltimore, MD, personal communication, June 1987.
  494. Phibbs, C. S., Institute for Health Policy Studies, University of California-San Francisco, San Francisco, CA, personal communication, Nov. 5, 1987.
  495. Phibbs, C. S., and Korenbrot, C. C., "Cost Impact of Comprehensive Prenatal Care on Medical With the Implementation of AB3021," testimony to the Ways and Means Committee of the California State Assembly, Apr. 16, 1986.
  496. Phibbs, C. S., Phibbs, R. H., Pomerance, J. J., et al., "Alternative to Diagnosis-Related Groups for Newborn Intensive Care," *Pediatrics* 78(5):829-836, 1986.
  497. Phibbs, C. S., Williams, R. L., and Phibbs, R. H., "Newborn Risk Factors and Costs of Neonatal Intensive Care," *Pediatrics* 68:313-21, 1981.
  498. Plotkin, R. C., Azar, S., Twentymen, C. T., et al., "A Critical Evaluation of the Research and Methodology Employed in Investigation of Causative Factors of Child Abuse and Neglect," *Child Abuse & Neglect* 5:449-451, 1981.
  499. Polansky, N., and Williams, D., "Class Orientation to Child Neglect," *Soc. Work* 23:397, 1978.
  500. Pollitt, E., and Leibel, R. L., "Iron Deficiency and Behavior," *J. Pediatrics* 88:372-381, 1976.
  501. Population Reference Bureau, Washington, DC, unpublished data on international infant mortality rankings, 1986.
  502. Porto, M., Nageotte, M. P., Hill, O., et al., "The Role of Home Uterine Activity Monitoring in the Prevention of Preterm Birth," abstract, paper presented at the annual meeting of the Society for Perinatal Obstetricians, Lake Buena Vista, FL, Feb. 5-7, 1987.
  503. Prager, K., National Center for Health Statistics, Public Health Service, U.S. Department of Health and Human Services, Hyattsville, MD, personal communication, Apr. 14, 1987.
  504. Pratt, W. F., Mosher, W. D., Bachrach, C. A., et al., "Understanding U.S. Fertility: Findings

- From the National Survey of Family Growth, Cycle III, " *Population Bulletin* 39(5), 1984.
505. Preblud, S. R., Orenstein, W. A., Koplan, J. P., et al., "A Benefit-Cost Analysis of a Childhood Varicella Vaccination Programmed," *Postgraduate Medical J.* 61(suppl.4):17-22, 1985.
  506. Present, P., U.S. Consumer Product Safety Commission, Washington, DC, personal communication, June 1987.
  507. President's Commission for the Study of Ethical Problems in Medicine and Biomedical and Behavioral Research, *Securing Access to Health Care: The Ethical Implications of Differences in the Availability of Health Services, Volume One: Report* (Washington, DC: U.S. Government Printing Office, March 1983).
  508. Preston, B. J., "Preventive Health Services for Children and Youth Under Medicaid: Early and Periodic Screening, Diagnosis and Treatment," prepared for the Office of Technology Assessment, U.S. Congress, Washington, DC, Jan. 14, 1987.
  509. Preusser, D. F., "Pedestrian Safety," *Proceedings of the Utah Child Injury Conference* (Salt Lake City, UT: Utah Department of Health, 1986).
  510. Public Child Fatality Review Committee, *Report of the Public Child Fatality Review Committee* (New York, NY: New York State Human Resources Administration, 1986).
  511. Public Health Foundation, *Public Health Agencies 1984: Vol. 4, An Inventory of Programs and Block Grant Expenditures* (Washington, DC: July 1986).
  512. Public Health Foundation, *An Inventory of Programs and Block Grant Expenditures, Public Health Agencies 1987* (Washington, DC: July 1987).
  513. Public Health Reports, "Indian Health Service Reaches Immunization Goal," *Public Health Reports* 98(1):51, 1983.
  514. Purnick, J., "Deaths of Two Infants Reviewed," *New York Times*, p. B3, Jan. 10, 1987.
  515. Quick, J. D., Greenlick, M. R., and Roghmann, K. J., "Prenatal Care and Pregnancy Outcome in an HMO and General Population: A Multivariate Cohort Analysis," *Am. J. Public Health* 71(4):381-390, 1981.
  - 515a. Ralph, N., and Edgington, A., "An Evaluation of an Adolescent Family Planning Program," *J. Adol. Health Care* 4(3):152-162, September 1983, as cited in Forster, 1986.
  516. Redman, C., "Screening for Pre-Eclampsia," *Effectiveness and Satisfaction in Antenatal Care*, M. Enkin and I. Chalmers (eds.) (Philadelphia, PA: J.B. Lippincott Co., 1982).
  517. Reeves, J. D., Vichinsky, E., Addiego, J., et al., "Iron Deficiency in Health and Disease," *Advances in Pediatrics* 30:281-320, 1983.
  518. Reinhold, R., "Safety Belts Becoming Thing To Wear in Texas," *New York Times*, p. A18, Feb. 1, 1987.
  519. Reis, J., Hughes, E., Pliska, S., et al., "An Assessment of the Validity of the Results of HCFA'S Demonstration and Evaluation Program for the Early and Periodic Screening, Diagnosis, and Treatment Program (EPSDT): A Metaevaluation," Center for Health Services and Policy Research, Northwestern University, Evanston, IL, June 30, 1979.
  520. Reis, J. S., Pliska, S. R., and Hughes, E., "A Synopsis of Federal-State Sponsored Preventive Child Health," *J. Community Health* 9:222-239, 1984.
  521. Reisinger, K. S., and Bires, J. A., "Anticipatory Guidance in Pediatric Practice," *Pediatrics* 66:889-892, 1980.
  522. Reisinger, K. S., and Williams, A. F., "Evaluation of Programs Designed To Increase the Protection of Infants in Cars," *Pediatrics* 62:280-287, 1978.
  523. Reisinger, K. S., Williams, A. F., Wells, J. K., et al., "Effect of Pediatricians' Counseling on Infant Restraint Use," *Pediatrics* 67:201-206, 1981.
  524. Resnick, M. B., Eyler, F. D., Nelson, R. M., et al., "Developmental Intervention for Low Birth Weight Infants: Improved Early Developmental Outcome," *Pediatrics* 80(1):68-74, 1987.
  525. Ricketts, S., Family Health Services Division, Colorado Department of Health, Denver, CO, internal memorandum, February 1986.
  526. Riegel, L., Center for Child Care Alternatives, Ltd., Washington, DC, personal communication, March 1987.
  527. Rivara, F. P., "Epidemiology of Childhood Injuries," *Preventing Childhood Injuries* (Columbus, OH: Ross Laboratories, 1982).
  528. Rivara, F. P., "Traumatic Deaths of Children in the United States: Currently Available Prevention Strategies," *Pediatrics* 75(3):456-462, 1985.
  529. Rivara, F. P., Culley, G. A., Hickok, D., et al., "A Health Program's Effect on Neonatal Mortality in Eastern Kentucky," *Am. J. Prev. Med.* 1(3):35-40, 1985.
  530. Roberts, S. D., Maxwell, D. R., and Gross, T. L., "Cost-Effective Care of End-Stage Renal Disease: A Billion Dollar Question," *Ann. Intern. Med.* 92:243-8, 1980.
  531. Robertson, L. S., "Behavioral Research and

- Strategies in Public Health: A Demur," *Social Science and Medicine* 9:165, 1975.
- 532 Robertson, L. S., "Crash Involvement of Teenaged Drivers When Driver Education is Eliminated From High School," *Am. J. Public Health* 70:599, 1980.
- 533, Robertson, L. S., "Environmental Hazards to Children: Assessment and Options for Amelioration," *Better Health for Our Children: The Report of the Select Panel for the Promotion of Child Health, Vol. V: Background Papers* (Washington, DC: U.S. Department of Health and Human Services, 1981).
- 534 Robertson, L. S., "Present Status of Knowledge in Childhood Injury Prevention," *Preventing Childhood Injuries*, A.B. Bergman (ed.) (Columbus, OH: Ross Laboratories, 1982),
- 535, Robertson, L. S., *Injuries, Causes, Control Strategies, and Public Policy* (Lexington, MA: Lexington Books, D.C. Heath & Co., 1983),
- 536, Robertson, L. S., "Automobile Safety Regulation: Rebuttal and New Data," *Am. J. Public Health* 74:1390, 1984.
- 537, Robertson, L. S., Washington DC, personal communication, 1987.
- 538, Robertson, L. S., "Childhood Injuries: Knowledge and Strategies for Prevention," prepared for the Office of Technology Assessment, U.S. Congress, Washington DC, February 1987.
539. Robertson, L. S., and Zador, P. L., "Driver Education and Fatal Crash Involvement of Teenaged Drivers," *Am. J. Public Health* 68:959, 1978.
540. Rogers, K. D., Ernst, R., Shulman, I., et al., "Effectiveness of Aggressive Followup on Navajo Infant Health and Medical Care Use," *Pediatrics* 53:721-725, 1974.
541. Rosenbaum, S., "The Maternal and Child Health Block Grant Act of 1981: Teaching an Old Program New Tricks," *Clearinghouse Review* 17(5):400-414, 1983.
542. Rosenbaum, S., "Financing Maternity Care for Low-Income Women: Results of a Nationwide Medicaid Survey," presented at the Annual Meeting of the American Public Health Association, Washington, DC, Nov. 20, 1985.
543. Rosenbaum, S. (ed.), *Community and Migrant Health Centers: Two Decades of Achievement* (Washington, DC: National Association of Community Health Centers, Inc., 1986).
544. Rosenbaum, S., and Johnson, K., "Providing Health Care for Low-Income Children: Reconciling Child Health Goals With Child Health Financing Realities," *Milbank Quarterly* 64:442-478, 1986.
545. Rosenzweig, M. R., and Schultz, T. P., "The Behavior of Mothers as Inputs to Child Health: The Determinants of Birth Weight, Gestation, and Rate of Fetal Growth," *Economic Aspects of Health*, V.R. Fuchs (ed.) (Chicago, IL: University of Chicago Press, 1982).
546. Rosenzweig, M. R., and Schultz, T. P., "Estimating a Household Production Function: Heterogeneity, the Demand for Health Inputs, and Their Effects on Birth Weight," Center Paper No. 346, Economic Growth Center, Yale University, New Haven, CT, September 1983.
547. Rosenzweig, M. R., and Schultz, T. P., "Effects of Mother's Behavior and Medical Treatment on Birthweight: United States 1980," unpublished paper, Economic Growth Center, Yale University, New Haven, CT, 1985.
548. Rosenzweig, M. R., and Schultz, T. P., "The Stability of Household Production Technology: A Replication," Center Discussion Paper No. 511, Economic Growth Center, Yale University, New Haven, CT, September 1986.
549. Roughmann, K. J., "Intervention Strategies for Children: A Research Agenda," *Health Services Research* 19(6 part II):887-943, 1985.
550. Rovet, J. F., and Glorieux, J., presentation at the Sixth International Neonatal Screening Symposium, Austin, TX, November 1986.
551. Rovet, J. F., Sorbara D.-L., and Ehrlich R. M., "The Intellectual and Behavioral Characteristics of Children With Congenital Hypothyroidism Identified by Neonatal Screening in Ontario: The Toronto Prospective Study," *Genetic Disease: Screening and Management*, T.P. Carter and A.M. Willey (eds.) (New York, NY: Alan R. Liss, Inc., 1986).
552. Royal College of General Practitioners and the General Medical Services Committee of the British Medical Association and the British Medical Association, *Handbook of Preventive Care for Pre-school Children* (London, England: 1984).
553. Royal College of Obstetricians and Gynaecologists, *Report of the R. C. O. G. Working Party on Antenatal and Intrapartum Care* (London, England: The Chameleon Press Ltd., September 1982).
554. Runyan, C. W., Ketch, J. B., Margolis, L. H., et al., "Childhood Injuries in North Carolina: A Statewide Analysis of Hospitalizations and Death," *Am. J. Public Health* 75:1429, 1985.
- 555 Runyan, D. K., Gould, C. L., Trost, D. C., et al., "Determinants of Foster Care Placement for the Maltreated Child," *Child Abuse & Neglect* 6:343-350, 1982.

556. Russell, D. E. H., "The Incidence and Prevalence of Intra-Familial and Extra-Familial Sexual Abuse of Female Children," *Child Abuse & Neglect* 7:133, 1983.
557. Russell, D. E. H., *The Secret Trauma: Incest in the Lives of Girls and Women* (New York, NY: Basic Books, 1986), as cited in Finkelhor and Araji, 1986.
558. Russell, L. B., *Is Prevention Better Than Cure?* (Washington, DC: Brookings Institution, 1986).
559. Rust, F., unpublished data from the Maternal and Child Health Data Base, University of California, Santa Barbara, CA, personal communication, August 1986, April and August 1987.
560. Ryan, G., Sweeney, P., and Solola, A., "Prenatal Care and Pregnancy Outcome," *Am. J. Obstet. Gynecol.* 137(8):876-881, 1980.
561. Sack, W. H., Mason, R., and Higgins, J. E., "The Single-Parent Family and Abusive Child Punishment," *Am. J. Orthopsych.* 55(2):252-59, 1985.
562. Sahs, J., Director, Bureau of Health Planning and Data Management, Nebraska Department of Health, Lincoln, NE, personal communication, November 1986.
563. Saunders, M. C., Dick, J. S., Brown, I. M., et al., "The Effects of Hospital Admission for Bed Rest on the Duration of Twin Pregnancy: A Randomised Trial," *Lancet* 1:793-795, 1985.
564. Scheidt, P., National Institute for Child Health and Human Development, National Institutes of Health, Public Health Service, U.S. Department of Health and Human Services, Rockville, MD, personal communication, June 1987.
565. Scherz, R. G., "Restraint Systems for the Prevention of Injury to Children in Automobile Accidents," *Am. J. Public Health* 66:451-456, 1976.
566. Schletty, A., Centers for Disease Control, Public Health Service, U.S. Department of Health and Human Services, Atlanta, GA, personal communication, June 1987.
567. Schoenbaum, S. C., Hyde, J. N., Jr., Bartoshevsky, L., et al., "Benefit-Cost Analysis of Rubella Vaccination Policy," *N. Eng. J. Med.* 294(6):306-310, 1976.
568. Schonkoff, J. P., and Hauser-Cram, P., "Early Intervention for Disabled Infants and Their Families—A Quantitative Analysis," *Pediatrics* 80(5):650-658, 1987.
569. Schramm, W., and Land, G., "Prenatal Care and Its Relationship to Medicaid Costs," prepared under HCFA Grant No. 11-P-98305, State Center for Health Statistics, Division of Health, Missouri Department of Social Services, December 1984.
570. Schuett, V. E., Gurda R. F., and Yandow, J. L., "Treatment Programs for PKU and Selected Other Metabolic Diseases in the United States: A Survey," DHHS Pub. No. (HRSA) 83-5296, U.S. Department of Health and Human Services, Public Health Service, Bureau of Health Care Delivery and Assistance, Rockville, MD, 1983.
571. Schultz, T. P., unpublished data from the 1980 National Natality Survey prepared for the Office of Technology Assessment, U.S. Congress, Washington, DC, July, 1986.
572. Schwartz, R., and Poppen, P., "Factors Affecting Pregnancy Outcomes," paper presented at the annual meeting of the American Public Health Association, Montreal, QU, August 1982.
573. Schwartz, R., and Poppen, P., *Measuring the Impact of CHC's on Pregnancy Outcomes* (Cambridge, MA: Abt Associates, Inc., Oct. 15, 1982).
574. Scriver, C. R., and Clew, C. L., "Phenylketonuria: Epitome of Human Biochemical Genetics," *N. Eng. J. Med.* part I 303(23):1336-1342, part II 303(23):1394-1400, 1980.
575. Seagull, E. A. W., "Social Support and Child Maltreatment: A Review of the Evidence," *Child Abuse & Neglect* 11:41-52, 1987.
576. Sepe, S. J., Levy, H. L., and Mount, F. W., "An Evaluation of Routine Followup Blood Screening of Infants for Phenylketonuria," *N. Eng. J. Med.* 300(11):606-609, 1979.
577. Sewall, C. M., Hull, H. F., Fenner, J., et al., "Child Restraint Law Effects on Motor Vehicle Accident Fatalities and Injuries: The New Mexico Experience," *Pediatrics* 78(6):1079-1084, 1986.
578. Shadish, W. R., "A Review and Critique of Controlled Studies of the Effectiveness of Preventive Child Health Care," *Health Policy Quarterly* 2:24-52, 1982.
579. Shapiro, S., Jacobziner, H., Densen, P. M., et al., "Further Observations on Prematurity and Perinatal Mortality in a General Population and in the Population of a Prepaid Group Practice Medical Care Plan," *Am. J. Public Health* 50(9):1304-1317, 1960.
580. Shapiro, S., McCormick, M. C., Starfield, B. H., et al., "Changes in Infant Morbidity Associated With Decreases in Neonatal Mortality," *Pediatrics* 72(3):408-15, 1983.
581. Shapiro, S., Weiner, L., and Densen, P. M., "Comparison of Prematurity and Perinatal Mortality in a General Population and in the

- Population of a Prepaid Group Practice Medical Care Plan," *Am. J. Public Health* 48(2):170-187, 1958.
582. Sherrod, K. B., O'Connor, S., Vietze, P. M., et al., "Child Health and Maltreatment," *Child Development* 55(4):1174-83, 1984.
583. Shiono, P. H., Klebanoff, M. A., Graubard, B. I., et al., "Birth Weight Among Women of Different Ethnic Groups," *J. A. M. A.* 255(1):48-52, 1986.
584. Showstack, J. A., Stone, M. H., and Schroeder, S. A., "The Role of Changing Clinical Practices in the Rising Costs of Hospital Care," *N. Eng. J. Med.* 313(19):1201-1207, 1985.
585. Shwartz, S., and Vinyard, J. H., "Prenatal Care and Prematurity," *Public Health Reports* 80(3):237-248, 1965.
586. Siegel, E., Bauman, K. E., Schaefer, E. S., et al., "Hospital and Home Support During Infancy: Impact on Maternal Attachment, Child Abuse and Neglect, and Health Care Utilization," *Pediatrics* 66(2): 183-190, 1980.
587. Simeonsson, R. J., Cooper, D. H., and Scheiner, A. P., "A Review and Analysis of the Effectiveness of Early Intervention Programs," *Pediatrics* 69(5):635-641, May 1982.
588. Simmons, J. T., *Programs That Work: Evidence of Primary Prevention of Child Abuse* (Houston, TX: Greater Houston Committee for Prevention of Child Abuse, 1986).
589. Singh, S., Torres, A., and Forrest, J. D., "The Need for Prenatal Care in the United States: Evidence From the 1980 National Natality Survey," *Fare. Plan. Perspectives* 17(3):118-124, 1985.
590. Sirotkin, B., Division of Immunization, Centers for Disease Control, Public Health Service, U.S. Department of Health and Human Services, Atlanta, GA, personal communication, January 1987.
591. Skeoch, C., Rosenberg, K., Turner, T., et al., "Very Low Birthweight Survivors: Illness and Readmission to Hospital in the First 15 Months of Life," *Br. Med. J.* 295:579-580, 1987.
592. Slazyk, W. E., Center for Environmental Health, Centers for Disease Control, Public Health Service, U.S. Department of Health and Human Services, Atlanta, GA, personal communication, 1986, 1987.
593. Sloan, F. A., Cromwell, J., and Mitchell, J. B., *Private Physicians and Public Programs* (Lexington, MA: Lexington Books, D.C. Heath & Co., 1978).
594. Smith, P. B., Wait, R. B., Mumford, D. M., et al., "The Medical Impact of an Antepartum Program for Pregnant Adolescents: A Statistical Analysis," *Am. J. Public Health* 68(2):169-172, 1978.
595. Smith, S. M., Hanson, R., and Noble, S., "Parents of Battered Babies: A Controlled Study," *Br. Med. J.* 4:388-91, 1973.
596. Snow, D. A., testimony before the Subcommittee on Commerce, Consumer Protection, and Competitiveness, Committee on Energy and Commerce, U.S. House of Representatives, U.S. Congress, Washington, DC, June 4, 1987.
597. Snyderman, S. E., "Newborn Metabolic Screening: Followup and Treatment Results," *Genetic Disease: Screening and Management*, T.P. Carter and A.M. Willey (eds.) (New York, NY: Alan R. Liss, Inc., 1986).
598. Sobel, R., "The Psychiatric Implications of Accidental Poisoning in Childhood," *Peal. Clin. North Am.* 17:653, 1970.
599. Soemantri, A. G., Pollitt, E., and Kim, I., "Iron Deficiency Anemia and Educational Achievement," *Am. J. Clin. Nutr.* 42:1221-1228, 1985.
600. Sokol, R. J., Woolf, R. B., Rosen, M. G., et al., "Risk, Antepartum Care, and Outcome: Impact of a Maternity and Infant Care Project," *Obstet./Gynecol.* 56(2):150-156, 1980.
601. Sola, A., untitled presentation at the Sixth International Neonatal Screening Symposium, Austin, TX, November 1986.
602. Soil, R. F., "Surfactant and Bronchopulmonary Dysplasia," paper presented at the Ross Laboratories Special Conference on Topics in Neonatology, Washington, DC, Dec. 7-9, 1986.
603. Sorkin, A. L., *Health Economics* (Lexington, MA: Lexington Books, D.C. Heath & Co., 1975).
604. Southern Regional Task Force on Infant Mortality, *Final Report: For the Children of Tomorrow* (Washington, DC: Southern Governors' Association, November 1985).
605. Southern Regional Task Force on Infant Mortality, *Interim Report* (Washington, DC: Southern Governors' Association, Feb. 24, 1985).
606. Spencer, M. J., and Dunklee, P., "Sexual Abuse of Boys," *Pediatrics* 78:83, 1986.
607. Spiegel, C. N., and Lindaman, F. C., "Children Can't Fly: A Program To Prevent Childhood Morbidity and Mortality From Window Falls," *Am. J. Public Health* 67:1143, 1977.
608. Spinetta, J. J., and Rigler, D., "The Child-Abusing Parent: A Psychological Review," *Psych. Bull.* 77:296, 1972.
609. Spiro, R., and Thuline, H., Department of Social and Health Services, State of Washington, and Glass, M., Washington State Public Health Laboratory, Department of Social and Health

- Services, Seattle, WA, BBB LLL personal communication, 1987.
- 609a. Spitz, H., Robin, G., McCarthy, B., et al., "The Impact of Publicly Funded Perinatal Care Programs on Neonatal Outcomes, Georgia, 1976-78," *Am. J. Obstet. Gynecol.* 147(3):295-300, 1983.
610. Starfield, B., *The Effectiveness of Medical Care: Validating Clinical Wisdom* (Baltimore, MD: Johns Hopkins University Press, 1985).
611. Starfield, B., and Dutton, D., "Care, Costs, and Health: Reactions to and Reinterpretation of the Rand Findings," *Pediatrics* 76:614-621, 1985.
612. Starfield, B., and Newacheck, P., "Children's Health and Use of Health Services," in *Children in a Changing Health Care System*, M. Schlesinger and L. Eisenberg (eds.) (Baltimore, MD: Johns Hopkins University Press, forthcoming).
613. Starr, R. H., Jr., "Physical Abuse of Children," *The Handbook of Family Violence*, V.B. Van Hasselt, R.L. Morrison, A.S. Bellack, et al. (eds.) (New York, NY: Plenum, 1987).
614. Starr, R. H., "A Research-Based Approach to the Prevention of Child Abuse," *Child Abuse Prediction: Policy Implications*, R.H. Starr (ed.) (Cambridge, MA: Ballinger, 1982).
615. State of California, Department of Health Care Services, Health and Welfare Agency, "Final Evaluation of the Obstetrical Access Pilot Project, July 1979-June 1982," Sacramento, CA, 1984.
616. State of California, Department of Health Care Services, Health and Welfare Agency, Medical Care Statistics Unit, unpublished data on physician practices receiving Medicaid payments, Sacramento, CA, 1986.
617. Steele, B. F., and Pollock, C. B., "A Psychiatric Study of Parents Who Abuse Infants and Small Children," *The Battered Child*, R.E. Heifer and C.H. Kempe (eds.) (Chicago, IL: University of Chicago Press, 1974).
618. Steele, P., and Spyker, D. A., "Poisonings," *Peal. Clin. North Am.* 32(1):77-86, 1985.
619. Stein, A., Campbell, E. A., Day, A., et al., "Social Adversity, Low Birth Weight, and Preterm Delivery," *Br. Med. J.* 295:291-293, 1987.
620. Steinberg, L. D., Catalano, R., and Dooley, D., "Economic Antecedents of Child Abuse and Neglect," *Child Development* 52:975-985, 1981.
621. Steiner, K. C., and Smith, H. A., "Application of Cost-Benefit Analysis to PKU Screening Program," *Inquiry* 10:34-40, 1973.
622. Steorts, N. H., testimony before the Subcommittee on Commerce, Consumer Protection, and Competitiveness, House of Representatives, U.S. Congress, Washington, DC, June 4, 1987.
623. Straus, M. A., "Stress and Child Abuse," *The Battered Child*, C.H. Kempe and R.E. Heifer (eds.) (Chicago, IL: University of Chicago Press, 1980).
624. Straus, M. A., personal communication, 1985, as cited in American Association for Protecting Children, 1986.
625. Straus, M. A., and Genes, R. J., "Societal Change and Change in Family Violence From 1975 to 1985 as Revealed by Two National Surveys," *J. Marriage & Family* 48:465-479, August 1986.
626. Straus, M. A., Genes, R. J., and Steinmetz, S. K., *Behind Closed Doors: Violence in the American Family* (Garden City, NY: Doubleday, Anchor Press, 1980).
627. Strobino, D. M., Chase, G. A., Kim, Y. J., et al., "The Impact of the Mississippi Improved Child Health Project on Prenatal Care and Low Birthweight," *Am. J. Public Health* 76(3):274-278, 1986.
628. Strobino, D. M., Kim, Y. J., Crawley, B. E., et al., "Declines in Nonwhite and White Neonatal Mortality in Mississippi, 1975 -80," *Public Health Reports* 100(4):417-427, 1985.
629. Sturner, R. A., Green, J. A., and Funk, S. G., "Preschool Denver Developmental Screening Test as a Predictor of Later School Problems," *J. Pediatrics* 107:615-621, 1985.
630. Sulvetta, M. B., and Swartz, K., *The Uninsured and Uncompensated Care* (Washington, DC: National Health Policy Forum, George Washington University, June 1986).
631. Swartz, K., Urban Institute, Washington, DC, "A Note on the Strengths and Weaknesses of Using the CPS To Estimate Children's Health Insurance Coverage," prepared for the Office of Technology Assessment, U.S. Congress, Washington, DC, 1986.
632. Swartz, K., Urban Institute, Washington, DC, statistical analysis of the Bureau of the Census' Current Population Survey, 1980, 1984, 1986, prepared for the Office of Technology Assessment, U.S. Congress, Washington, DC, 1986.
633. Tanaka, K., and Rosenberg, L. E., "Disorders of Branched-Chain Amino Acid and Organic Acid Metabolism," *The Metabolic Basis of Inherited Disease*, J.B. Stanbury, J.B. Wyngaarden, D.S. Fredrickson, et al. (eds.) (New York, NY: McGraw-Hill, 1985).
634. Tarnow-Mordi, W., and Wilkinson, A., "Mechanical Ventilation of the Newborn," *Br. Med. J.* 292:575-576, 1986.
635. Taylor, B., Wadsworth, J., and Butler, N. R.,

- “Teenage Mothering, Admission to Hospital, and Accidents During the First 5 Years,” *Archives of Disease in Childhood* 58:6-11, 1983.
636. Teret, S. P., Jones, A. S., Williams, A. F., et al., “Child Restraint Laws: An Analysis of Gaps in Coverage,” *Am J. Public Health* 76(1):31-34, 1986.
637. Terris, M., and Glasser, M., “A Life Table Analysis of the Relation of Prenatal Care to Prematurity,” *Am J. Public Health* 64(9):869-875, 1974.
638. Terris, M., and Gold, E., “An Epidemiologic Study of Prematurity: Part II, Relation to Prenatal Care, Birth Interval, Residential History, and Outcome of Previous Pregnancies,” *Am. J. Obstet. Gynecol.* 103(3):371-379, 1969.
639. Testa, M., and Lawlor, E., *The State of the Child, 1985* (Chicago, IL: The Chapin Hall Center for Children, 1985).
640. Therrell, B., Texas Department of Health, Austin, TX, personal communication, 1986.
- 640a. Therrell, B. L., (cd.), “Screening Status Reports,” *Infant Screening Newsletter* 10(2):3-4, October 1987.
641. Thoennes, N., and Pearson, J., “Summary of Findings From the Sexual Abuse Allegations Project,” Association of Family and Conciliation Courts, Portland, OR, 1987.
642. Thomas, L., “Aspects of Biomedical Science Policies,” Washington, DC, National Academy of Sciences, Nov. 9, 1972; Reprint, Institute of Medicine Report, National Academy of Sciences, 1976.
643. Tomasi, A. M., Eden, R. D., Canlas, V. M., et al., “Can Preterm Labor Be Predicted by Ambulatory Tocodynamometry,” abstract, paper presented at the annual meeting of the Society for Perinatal Obstetricians, Lake Buena Vista, FL, Feb. 5-7, 1987.
644. Tourian, A., and Sidbury, J. B., “Phenylketonuria and Hyperphenylalaninemia,” *The Metabolic Basis of Inherited Disease*, J.B. Stanbury, J.B. Wyngaarden, D.S. Fredrickson, et al. (eds.) (New York, NY: McGraw-Hill, 1985).
645. Trinkoff, A. M., and Baker, S. P., “Poisoning, Hospitalizations and Deaths From Solids and Liquids Among Children and Teenagers,” *Am. J. Public Health* 76:657, 1986.
646. Trowbridge, F., “Prevalence of Growth Stunting and Obesity: Pediatric Nutrition Surveillance System, 1982,” *MMWR: Surveillance Summaries* 32(4SS):23SS-26SS, 1983, as cited in Miller, Fine, Adams-Taylor, et al., 1986.
647. Tuerck, J. M., Buist, N. R. M., Skeels M. R., et al., “Computerized Surveillance of Errors in Newborn Screening,” *Am. J. Public Health* 77(12):1528-1531, 1987.
648. U.S. Congress, Congressional Budget Office, *Reducing Poverty Among Children* (Washington, DC: May 1985).
649. U.S. Congress, Congressional Budget Office, Human Resources and Community Development Division, *A Methodology for Estimating the Impacts of Extending Medicaid Coverage to All Pregnant Women and Children With Incomes Below the Poverty Level* (Washington, DC: August 1986).
650. U.S. Congress, General Accounting Office, *Preventing Mental Retardation—More Can Be Done*, GAO HRD 77-37 (Washington, DC: 1977).
651. U.S. Congress, General Accounting Office, *Increased Federal Efforts Needed To Better Identify, Treat, and Prevent Child Abuse and Neglect*, HRD-80-66 (Washington, DC: U.S. Government Printing Office, Apr. 29, 1980).
652. U.S. Congress, General Accounting Office, *Medical Malpractice: Insurance Costs Increased But Varied Among Physicians and Hospitals*, GAO/HRD-86-112 (Washington, DC: September 1986).
- 652a. U.S. Congress, General Accounting Office, *Teenage Pregnancy: 500,000 Births a Year But Few Tested Programs*, Briefing report to the Hon. John H. Chafer, U.S. Senate, PEMD-86-16BR (Washington, DC: July 1986).
653. U.S. Congress, General Accounting Office, *Prenatal Care: Medicaid Recipients and Uninsured Women Obtain insufficient Care*, G/10/I-II? D-87-137 (Washington, DC: September 1987).
654. U.S. Congress, House of Representatives, Committee on Energy and Commerce, Subcommittee on Health and the Environment, *Childhood Immunizations* (Washington, DC: U.S. Government Printing Office, September 1986).
655. U.S. Congress, House of Representatives, Committee on Governmental Operations, Subcommittee on Intergovernmental Relations and Human Resources, *Hearing on the Emergency Aid to Families' Program* (Washington, DC: U.S. Government Printing office, Mar. 12, 1987).
656. U.S. Congress, House of Representatives, Select Committee on Children, Youth, and Families, *Federal Programs Affecting Children*, Committee Print 29-223-O (Washington, DC: U.S. Government Printing Office, January 1984).
657. U.S. Congress, House of Representatives, Select Committee on Children, Youth, and Fam-

- ilies, *Abused Children in America: Victims of Official Neglect*, H.R. 100-260 (Washington, DC: U.S. Government Printing Office, July 1987).
658. U.S. Congress, Office of Technology Assessment, *A Review of Selected Federal Vaccine and Immunization Policies*, OTA-H-96 (Washington, DC: U.S. Government Printing Office, September 1979).
659. U.S. Congress, Office of Technology Assessment, *The Implications of Cost-Effectiveness Analysis of Medical Technology*, OTA-H-126 (Washington, DC: U.S. Government Printing Office, August 1980).
660. U.S. Congress, Office of Technology Assessment, *Strategies for Medical Technology Assessment*, OTA-H-81 (Washington, DC: U.S. Government Printing Office, September 1982).
661. U.S. Congress, Office of Technology Assessment, *Payment for Physician Services: Strategies for Medicare*, OTA-H-294 (Washington, DC: U.S. Government Printing Office, February 1986).
662. U.S. Congress, Office of Technology Assessment, *Indian Health Care*, OTA-H-290 (Washington, DC: U.S. Government Printing Office, April 1986).
663. U.S. Congress, Office of Technology Assessment, *Children's Mental Health: Problems and Services*, OTA-BP-H-33 (Washington, DC: U.S. Government Printing Office, December 1986).
664. U.S. Congress, Office of Technology Assessment, *Technology-Dependent Children: Hospital v. Home Care*, OTA-TM-H-38 (Washington, DC: U.S. Government Printing Office, May 1987).
665. U.S. Congress, Office of Technology Assessment, *Neonatal Intensive Care for Low Birth-weight Infants: Costs and Effectiveness*, OTA-HCS-38 (Washington, DC: U.S. Government Printing Office, December 1987).
666. U.S. Congress, Senate, Committee on Governmental Affairs, *National Commission To Prevent Infant Mortality*, report to accompany S. 1209 (Washington, DC: U.S. Government Printing Office, 1986).
667. U.S. Consumer Product Safety Commission, *NEISS Data Highlights*, vol. 9, Washington, DC, January-December 1985.
668. U.S. Consumer Product Safety Commission, personal communication to L. Robertson, November 1986, as cited in Robertson, February 1987.
669. U.S. Department of Commerce, Bureau of the Census, *Statistical Abstract of the U. S.: 1979* (Washington, DC: 1979).
670. U.S. Department of Commerce, Bureau of the Census, *Statistical Abstract of the U. S.: 1985* (Washington, DC: 1985).
671. U.S. Department of Commerce, Bureau of the Census, "Child Support and Alimony: 1983 (Supplemental Report), " *Current Population Reports, Special Studies, Series P-13, No. 148* (Washington, DC: 1986).
672. U.S. Department of Commerce, Bureau of the Census, Washington, DC, Current Population Survey, March 1986.
673. U.S. Department of Health and Human Services, Health Care Financing Administration, *Health Care Financing Program Statistics: Analysis of State Medicaid Program Characteristics, 1984* (Baltimore, MD: August 1985).
674. U.S. Department of Health and Human Services, Health Care Financing Administration, *Health Care Financing Program Statistics: Analysis of State Medicaid Program Characteristics, 1986*, HCFA Pub. No. 03249 (Baltimore, MD: August 1987).
675. U.S. Department of Health and Human Services, Office of Human Development Services, Administration for Children, Youth, and Families, *Head Start: A Child Development Program*, (Washington, DC: 1986).
676. U.S. Department of Health and Human Services, Office of Human Development Services, Administration for Children, Youth and Families, "Project Head Start Statistical Fact Sheet," mimeographed sheet, Washington, DC, January 1987,
677. U.S. Department of Health and Human Services, Office of Human Development Services, Administration for Children, Youth, and Families, Children's Bureau, National Center on Child Abuse and Neglect, *Study Findings: National Study of Incidence and Severity of Child Abuse and Neglect*, DHHS Pub. No. (OHDS) 81-30325 (Washington, DC: 1981).
678. U.S. Department of Health and Human Services, Office of Human Development Services, Administration for Children, Youth and Families, Children's Bureau, National Center on Child Abuse and Neglect, calculated from "Discretionary Grants: Profiles for Fiscal Year 1986," Washington, DC, 1987.
679. U.S. Department of Health and Human Services, Public Health Service, *Promoting Health/Preventing Disease: Objectives for the Nation*, DHHS Pub. No. (OM) 81-0007 (Washington, DC: 1980).



680. U.S. Department of Health and Human Services, Public Health Service, *Better Health for Our Children: A National Strategy*, the report of the Select Panel for the Promotion of Child Health, DHHS Pub. No. (PHS) 79-55071 (Washington, DC: U.S. Government Printing Office, 1981).
681. U.S. Department of Health and Human Services, Public Health Service, Centers for Disease Control, "Poliomyelitis Prevention," *Morbidity and Mortality Weekly Report* 31(3):22-26, 31-34, 1982.
682. U.S. Department of Health and Human Services, Public Health Service, Centers for Disease Control, *CDC organization and Functions Manual* (Atlanta, GA: 1984).
683. U.S. Department of Health and Human Services, Public Health Service, Centers for Disease Control, "Nutrition Surveillance: Annual Summary 1983," DHHS Pub. No. (CDC) 85-8295, Washington, DC, 1985, as cited in Miller, Fine, Adams-Taylor, et al., 1986.
684. U.S. Department of Health and Human Services, Public Health Service, Centers for Disease Control, "Polysaccharide Vaccine for Prevention of *Haemophilus influenzae* Type b Disease," *Morbidity and Mortality Weekly Report* 34(15):201-205, 1985.
685. U.S. Department of Health and Human Services, Public Health Service, Centers for Disease Control, "Premature Mortality Due to Unintentional Injuries—United States, 1983," *Morbidity and Mortality Weekly Report* 35(22):353-356, 1986.
686. U.S. Department of Health and Human Services, Public Health Service, Centers for Disease Control, *State Immunization Requirements, 1985-1986* (Atlanta, GA: March 1986).
687. U.S. Department of Health and Human Services, Public Health Service, Centers for Disease Control, preliminary tables from the National Infant Mortality Surveillance Project, Atlanta, GA, May 1986.
688. U.S. Department of Health and Human Services, Public Health Service, Centers for Disease Control, "Measles—United States, First 26 Weeks, 1986," *Morbidity and Mortality Weekly Report* 35(33):525-533, 1986.
689. U.S. Department of Health and Human Services, Public Health Service, Centers for Disease Control, "Declining Anemia Prevalence Among Children Enrolled in Public Nutrition and Health Programs—Selected States, 1975-1985," *Morbidity and Mortality Weekly Report* 35(36):565-566, 1986.
690. U.S. Department of Health and Human Services, Public Health Service, Centers for Disease Control, "New Recommended Schedule for Active Immunization of Normal Infants and Children," *Morbidity and Mortality Weekly Report* 35(37):577-579, 1986.
691. U.S. Department of Health and Human Services, Public Health Service, Centers for Disease Control, "Rubella and Congenital Rubella Syndrome—New York City," *Morbidity and Mortality Weekly Report* 35(50):770-779, 1986.
692. U.S. Department of Health and Human Services, Public Health Service, Centers for Disease Control, unpublished data from the U.S. Immunization Survey, 1979-1986, Atlanta, GA, 1987.
693. U.S. Department of Health and Human Services, Public Health Service, Centers for Disease Control, unpublished data from the U.S. School Entry Immunization Survey, 1980-1986, Atlanta, GA, 1987.
694. U.S. Department of Health and Human Services, Public Health Service, Centers for Disease Control, "Unintentional Ingestions of Prescription Drugs in Children Under Five Years Old," *Morbidity and Mortality Weekly Report* 36(9):124-132, 1987.
695. U.S. Department of Health and Human Services, Public Health Service, Health Resources and Services Administration, Bureau of Health Care Delivery and Assistance, "Primary Care: Community Health Center Program," mimeographed sheet, Rockville, MD, 1987.
696. U.S. Department of Health and Human Services, Public Health Service, Health Resources and Services Administration, Bureau of Health Care Delivery and Assistance, "Primary Care: Migrant Health Program," mimeographed sheet, Rockville, MD, 1987.
697. U.S. Department of Health and Human Services, Public Health Service, Health Resources and Services Administration, Bureau of Health Care Delivery and Assistance, Division of Maternal and Child Health, *Abstracts of Active Projects FY 2986* (Rockville, MD: 1986).
698. U.S. Department of Health and Human Services, Public Health Service, National Center for Health Statistics, National Medical Care Utilization and Expenditure Survey, Hyattsville, MD, 1980.
699. U.S. Department of Health and Human Services, Public Health Service, National Center for Health Statistics, *Vital Statistics of the United States, 1977, Vol. I: Natality*, DHHS Pub. No. (PHS) 81-1113 (Washington, DC: U.S. Govern-

- ment Printing office, 1981).
700. U.S. Department of Health and Human Services, Public Health Service, National Center for Health Statistics, *State Definitions and Reporting Requirements for Live Births, Fetal Deaths, and Induced Terminations of Pregnancy* (Hyattsville, MD: revised 1981), as cited in Wilson, Fenton, Munson, et al., 1986.
  701. U.S. Department of Health and Human Services, Public Health Service, National Center for Health Statistics, unpublished data from the National Health Interview Survey, Hyattsville, MD, 1981.
  702. U.S. Department of Health and Human Services, Public Health Service, National Center for Health Statistics, unpublished data from the U.S. vital statistics, Hyattsville, MD, 1982.
  703. U.S. Department of Health and Human Services, Public Health Service, National Center for Health Statistics, "Advance Report of Final Natality Statistics, 1982," *Monthly Vital Statistics Report*, vol. 33, No. 6 (Suppl.), DHHS Pub. No. (PHS) 84-1120, Hyattsville, MD, Sept. 28, 1984.
  704. U.S. Department of Health and Human Services, Public Health Service, National Center for Health Statistics, *Vital Statistics of the United States, 1981, Vol. I: Natality*, DHHS Pub. No. (PHS) 85-1113 (Washington, DC: U.S. Government Printing office, 1985).
  705. U.S. Department of Health and Human Services, Public Health Service, National Center for Health Statistics, "Persons Injured and Disability Days Due to Injuries, United States, 1980-1981," *Vital and Health Statistics*, Series 10, No. 149, DHHS Pub. No. (PHS) 85-1577 (Hyattsville, MD: March 1985).
  706. U.S. Department of Health and Human Services, Public Health Service, National Center for Health Statistics, *Proceedings of the International Collaborative Effort on Perinatal and Infant Mortality*, vol. I (Hyattsville, MD: August 1985).
  707. U.S. Department of Health and Human Services, Public Health Service, National Center for Health Statistics, unpublished data from the National Hospital Discharge Survey, 1986.
  708. U.S. Department of Health and Human Services, Public Health Service, National Center for Health Statistics, unpublished data from the National Survey of Family Growth, Hyattsville, MD, 1986.
  709. U.S. Department of Health and Human Services, Public Health Service, National Center for Health Statistics, unpublished data from the U.S. vital statistics, Hyattsville, MD, 1986, 1987.
  710. U.S. Department of Health and Human Services, Public Health Service, National Center for Health Statistics, unpublished data in preparation for *Vital Statistics of the United States: 1984, Vol. I: Natality*, Hyattsville, MD, 1986.
  711. U.S. Department of Health and Human Services, Public Health Service, National Center for Health Statistics, "Current Estimates From the National Health Interview Survey, United States, 1983," *Vital and Health Statistics*, Series 10, No. 154, DHHS Pub. No. (PHS) 86-1582 (Washington, DC: U.S. Government Printing Office, June 1986).
  - 711a. U.S. Department of Health and Human Services, Public Health Service, National Center for Health Statistics, "Current Estimates From the National Health Interview Survey, United States, 1985," *Vital and Health Statistics*, Series 10, No. 160, DHHS Pub. No. (PHS) 86-1588 (Washington, DC: U.S. Government Printing office, 1986).
  712. U.S. Department of Health and Human Services, Public Health Service, National Center for Health Statistics, "Advance Report of Final Natality Statistics, 1984," *Monthly Vital Statistics Report*, vol. 35, No. 4 (Suppl.), DHHS Pub. No. (PHS) 86-1120, Hyattsville, MD, July 18, 1986.
  713. U.S. Department of Health and Human Services, Public Health Service, National Center for Health Statistics, unpublished data on accidental fatalities among children, Hyattsville, MD, 1987.
  714. U.S. Department of Health and Human Services, Public Health Service, National Center for Health Statistics, Hyattsville, MD, personal communication, Feb. 24, 1987.
  715. U.S. Department of Health, Education, and Welfare, Public Health Service, Office of the Assistant Secretary for Health and Surgeon General, *Healthy People: The Surgeon General's Report on Health Promotion and Disease Prevention*, DHEW (PHS) Pub. No. 79-55071 (Washington, DC: U.S. Government Printing Office, 1979).
  716. U.S. Department of Health and Human Services, Public Health Service, Office of Disease Prevention and Health Promotion, *The 1990 Health Objectives for the Nation: A Midcourse Review* (Washington, DC: November 1986).
  717. U.S. Department of Justice, Federal Bureau of Investigation-Uniformed Crime Reports, *Crime in the U. S., 1979* (Washington, DC: U.S. Gov-

- ernment Printing Office, 1980).
718. U.S. Department of Labor, Bureau of Labor Statistics, *Employee Benefits in Medium and Large Firms, 1984*, Bulletin 2237 (Washington, DC: U.S. Government Printing Office, June 1985).
  719. U.S. Department of Transportation, National Highway and Traffic Safety Administration, unpublished data on child restraint laws, Washington, DC, June 1987 and July 1, 1987.
  720. U.S. Department of Transportation, National Highway and Traffic Safety Administration, Office of Program and Rulemaking Analysis, "Preliminary Report: The Cost of Automobile Safety Regulations," Washington, DC, March 1982.
  721. U.S. Executive Office of the President, Council of Economic Advisors, *The Economic Report of the President to the Congress* (Washington, DC: U.S. Government Printing Office, February 1986).
  722. U.S. Federal Emergency Management Agency, U.S. Fire Administration, *Residential Smoke and Fire Detector Coverage in the United States: Findings From a 1982 Survey* (Washington, DC: 1983).
  723. UNICEF, *The State of the World's Children* (New York, NY: 1987).
  724. United Press International, "State Says Doctors Treating More Medi-Cal Patients, Pay Claims Rise," *Sacramento Bee*, p. A-18, Aug. 13, 1975.
  725. University Associates, *Infant Health Initiative Program Final Report* prepared for the Bureau of Community Services, Michigan Department of Public Health (Lansing, MI: December 1985).
  726. Valdez, R. O. B., *The Effects of Cost Sharing on the Health of Children* (Santa Monica, CA: Rand Corp., 1986).
  727. Van Pelt, A., and Levy, H. L., "Cost-Benefit Analysis of Newborn Screening for Metabolic Disorders," *N. Eng. J. Med.* 291:1414-1416, 1974.
  728. Vasquez-Sloane, P., Windom, R., and Pearson, H. A., "Disappearance of Iron-Deficiency Anemia in a High-Risk Infant Population Given Supplemental Iron," *N. Eng. J. Med.* 313:1239-1240, 1987.
  729. Veale, A. M. O., "Screening for Phenylketonuria," *Neonatal Screening for Inborn Errors of Metabolism*, H. Bickel, R. Guthrie, and G. Hammersen (eds.) (Berlin, East Germany: Springer-Verlag, 1980).
  730. Ventry, I. M., "Effects of Conductive Hearing Loss: Fact or Fiction?" 1. *Speech Hear. Disorder* 45:143-56, 1980.
  731. Vietze, P., Falsey, S., Sandier, H., et al., "Transactional Approach to Prediction of Child Maltreatment," *Infant Mental Health J.* 1(4):248-261, 1980.
  732. Virginia Division for Children, "EPSDT: Virginia's Health Screening Program for Low Income Children—Time of Transition," Part 11, Richmond, VA, March 1985.
  733. Von Cube, A., Population Reference Bureau, Washington, DC, personal communication, May and September 1987.
  734. Wagner, J. L., "The Economic Evaluation of Medicines: A Review of the Literature," prepared for the Pharmaceutical Manufacturers' Association, Washington, DC, August 1982.
  735. Waisbren, S. E., Norman, T. R., Schnell, R. R., et al., "Speech and Language Deficits in Early-Treated Children With Galactosemia," *J. Pediatrics* 102(1):75-77, 1983.
  736. Walker, D. B., Feldman, A., Vohr, B. R., et al., "Cost-Benefit Analysis of Neonatal Intensive Care for Infants Weighing Less Than 1,000 Grams at Birth," *Pediatrics* 74(1):20-25, 1984.
  737. Walter, T., Kovalskys, J., and Stekel, A., "Effect of Mild Iron Deficiency on Infant Mental Development Scores," *J. Pediatrics* 102:519-522, 1983.
  738. Warner, K., *Mandatory Passive Restraint Systems in Automobiles: Issues and Evidence* (Background Paper #1, *Technology and Handicapped People*), prepared for the Office of Technology Assessment, U.S. Congress, OTA-BP-H-15 (Springfield, VA: National Technical Information Service, September 1982).
  739. Washington Report on Medicine & Health, "Lederle, Connaught Drop DPT Prices," *Washington Report on Medicine & Health* 41 (20):2, 1987.
  740. Washington Report on Medicine & Health, "Briefly This Week," *Washington Report on Medicine & Health* 41(22):4, 1987.
  741. Webb, J. F., "PKU Screening—Is It Worth It?" *Can. Med. Assn. J.* 108:328-329, 1973.
  742. Webb, T. E., and Oski, F. A., "Iron Deficiency Anemia and Scholastic Achievement in Young Adolescents," *J. Pediatrics* 82:827-830, 1983.
  743. Weibel, R. E., Kuter, B. J., Neff, B. I., et al., "Live Oka/Merck Varicella Vaccine in Healthy Children," *J. A.M.A.* 254(17):2435-2439, 1985.
  744. Weisbrod, B. A., "Costs and Benefits of Medical Research: A Case Study of Poliomyelitis," *J. Political Economy* 79(3):527-544, 1971.
  745. Weiss, B. D., "Bicycle Helmet Use by Children," *Pediatrics* 77(5):677-679, 1986.
  746. Welch, N. M., and Kesler, R. W., "The Value of

- the Preschool Examination in Screening for Health Problems, " *J. Pediatrics* 100:232-234, 1982.
747. Wethers, D. L., and Grover, R., "Screening the Newborn for Sickle Cell Disease: Is It Worth the Effort?" *Genetic Disease: Screening and Management*, T.P. Carter and A.M. Willey (eds.) (New York, NY: Alan R. Liss, Inc., 1986).
748. White, C. C., Koplan, J. P., and Orenstein, W. A., "Benefits, Risks and Costs of Immunization for Measles, Mumps and Rubella, " *Am. J. Public Health* 75(7):739-744, 1985.
749. White, K. R., and Mott, S. E., "Conducting Longitudinal Research on the Efficacy of Early Intervention With Handicapped Children, " unpublished paper, Utah State University, Logan, UT, no date.
750. Whiting, L., "Defining Emotional Neglect, " *Child Abuse & Neglect* 5:2, 1976.
751. Wilkinson, A., Jenkins, P. A., and Jeffrey, J. A., "Two Controlled Trials of Dry Artificial Surfactant: Early Effects and Later Outcome in Babies With Surfactant Deficiency, " *Lancet* 2:287-291, 1985.
752. Williams, A. F., Wong, J., and O'Neill, B., "Occupant Protection in Interior Impacts: An Analysis of Federal Motor Safety Standard No. 201, " *Proceedings of the 23rd Conference of the American Association for Automotive Medicine* (Morton Grove, IL: American Association for Automotive Medicine, 1979).
753. Williams, A. K., and Wells, J. K., "The Tennessee Child Restraint Law in Its Third Year, " *Am. J. Public Health* 71:163, 1981.
754. Williams, R., and Chen, P., "Identifying the Source of the Recent Decline in Perinatal Mortality Rates in California, " *N. Eng. J. Med.*, 306(4):207-214, 1982.
755. Wilson, A. L., Fenton, L. J., and Munson, D. P., "State Reporting of Live Births of Newborns Weighing Less Than 500 Grams: Impact on Neonatal Mortality Rates, " *Pediatrics* 78(5) :850-854, 1986.
756. Wilson, R. W., "Do Health Indicators Indicate Health?" (editorial), *Am. J. Public Health* 71(5):461-463, 1981.
757. Wise, P. H., Kotelchuck, M., Wilson, M. L., et al., "Racial and Socioeconomic Disparities in Childhood Mortality in Boston, " *N. Eng. J. Med.* 313(6):360-366, 1985.
758. Witte, J., and Axnick, N., "The Benefits From 10 Years of Measles Immunization in the United States, " *Public Health Reports* 90(3):205-207, 1975.
759. Wolf, B., Department of Human Genetics, Medical College of Virginia, Richmond, VA, personal communication, November 1987.
760. Wolf, B., Heard, G. S., Jefferson, L. G., et al., "Neonatal Screening of Biotinidase Deficiency, " presentation at the International Symposium on Newborn Screening, Austin, TX, November 1986.
761. Wolfe, D. A., "Child-Abusive Parents: An Empirical Review and Analysis, " *Psychological Bulletin* 97:462-482, 1985.
762. Wolfe, D. A., and Mosk, M. D., "Behavioral Comparisons of Children From Abusive and Distressed Families, " *J. Consult. Clin. Psych.* 51:702, 1983.
763. Wood, S. C., and Dean, K. S., *Final Report: Sexual Abuse of Males Research Project* (Washington, DC: National Center on Child Abuse and Neglect, 1984), as cited in Finkelhor and Araji, 1986.
764. Woodling, B. A., and Heger, A., "The Use of the Colposcope in the Diagnosis of Sexual Abuse in the Pediatric Age Group, " *Child Abuse & Neglect* 10:111, 1986.
765. World Health Organization 1986 *World Health Statistics Annual* (Geneva, Switzerland: 1986).
766. Wright, P. H., *A Study To Evaluate the Effectiveness of Traffic Countermeasures at Horizontal Curb Locations* (Atlanta, GA: Georgia Institute of Technology, 1982).
767. Wright, P. H., and Robinson, L. S., "Studies of Roadside Hazards for Projecting Fatal Crash Sites, " *Transportation Research Record, No. 609* (Washington, DC: National Academy of Sciences, 1976).
768. Wyatt Co., 1984 *Group Benefits Survey* (Washington, DC: 1985).
769. Wyatt, G. E., and Peters, S. D., "Issues in the Definition of Child Sexual Abuse in Prevalence Research, " *Child Abuse & Neglect* 10:231, 1986.
770. Yankauer, A., "Child Health Supervision—Is It Worth It?" *Pediatrics* 52:272-279, 1973.
771. Yankauer, A., and Lawrence, R. A., "A Study of Periodic School Medical Examinations—I. Methodology and Initial Findings, " *Am. J. Public Health* 45:71-78, 1955.
772. Yankauer, A., and Lawrence, R., "A Study of Periodic School Medical Examinations—II. The Annual Increment of New 'Defects', " *Am. J. Public Health* 55:1553-1562, 1956.
773. Yankauer, A., Lawrence, R., and Ballou, L., "A Study of Periodic School Medical Examinations—111. The Remediability of Certain Categories of 'Defects', " *Am. J. Public Health* 47:1421-1429, 1957.
774. Yeaton, W. H., and Bailey, J. S., "Teaching

- Pedestrian Safety Skills to Young Children: An Analysis and One-Year Followup," *J. Applied Behavior Analysis* 11 :315, 1978.
775. Yu, V. Y. H., "The Case for Neonatal Intensive Care," *Med. J. Australia* 142:353-355, 1985.
776. Zabin, L., "The Impact of Early Use of Prescription Contraceptives on Reducing Premarital Teenage Pregnancies," *Fare. Plan. Perspectives* 13(2):72-74, 1981.
- 776a. Zabin, L., and Clark, J., "Institutional Factors Affecting Teenagers' Choice and Reasons for Delay in Attending a Family Planning Clinic," *Family Planning Perspectives* 15(1):25-29, 1983,
- as cited in Foster, 1986.
777. Zabin, L., Hirsch, M., Smith, E., et al., "Evaluation of a Pregnancy Prevention Program for Urban Teenagers," *Fare. Plan. Perspectives* 18(3):119-126, 1986.
778. Zador, P., Moshman, I., and Marcus, L., "Adoption of Right Turn on Red: Effects on Crashes at Signalized Intersections," *Accident Analysis & prevention* 14(3) :219-234, 1982.
779. Zwick, D. I., "Federal Health Services Grants, 1985," *Public Health Reports* 101 (5):499-504, 1986.