

*Marine Minerals: Exploring Our New
Ocean Frontier*

July 1987

NTIS order #PB87-217725

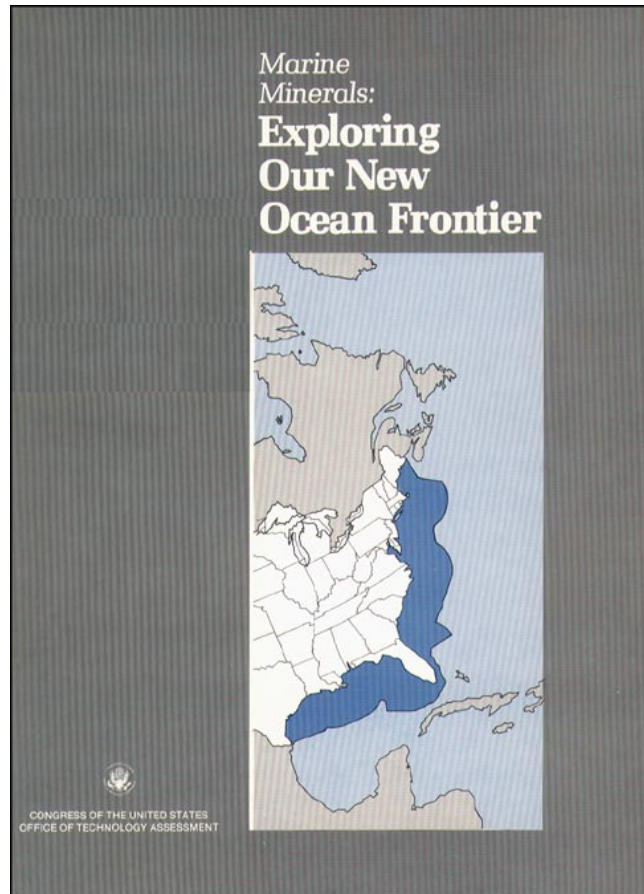

Recommended Citation:

U.S. Congress, Office of Technology Assessment, *Marine Minerals: Exploring Our New Ocean Frontier, OTA-O-342* (Washington, DC: U.S. Government Printing Office, July 1987),

Library of Congress Catalog Card Number 87-619837

**For sale by the Superintendent of Documents
U.S. Government Printing Office, Washington, DC 20402-9325
(order form on p. 349)**

Foreword

Throughout history, man has been fascinated by the mysteries that lay hidden below the ocean surface. Jules Verne, the 19th century novelist, author of *20,000 Leagues Under the Sea*, captured the imagination and curiosity of the public with his fictional-but nonetheless farsighted—accounts of undersea exploration and adventure. Since his classic portrayal of life beneath the ocean, technology has enabled us to bridge the gap between Jules Verne's fiction and the realities that are found in ocean space. Although the technological triumphs in ocean exploration are phenomenal, the extent of our current knowledge about the resources that lie in the seabed is very limited.

In 1983, the United States asserted control over the ocean resources within a 200-nautical mile band off its coast, as did a large number of other maritime countries. Within this so-called Exclusive Economic Zone (EEZ) is a vast area of seabed that might contain significant amounts of minerals. It is truly the Nation's "New Frontier."

This report on exploring the EEZ for its mineral potential is in response to a joint request from the House Committee on Merchant Marine and Fisheries and the House Committee on Science, Space, and Technology. It examines the current knowledge about the hard mineral resources within the EEZ, explores the economic and security potential of seabed resources, assesses the technologies available to both explore for and mine those resources, identifies issues that face the Congress and the executive branch, and finally presents options to the Congress for dealing with these issues.

Substantial assistance was received from many organizations and individuals in the course of this study. We would like to express special thanks to the OTA advisory panel; the numerous participants in our workshops; the project's contractors and consultants for contributing their special expertise; the staffs of the executive agencies that gave selflessly of their knowledge and counsel; the many reviewers who kept us intellectually honest and factually accurate; and our sister congressional agency, the Congressional Research Service, for making available its expertise in seabed minerals. OTA, however, remains solely responsible for the contents of this Report.



JOHN H. GIBBONS

Director

LIBRARY
OFFICE OF LEGISLATIVE ASSISTANCE
CONGRESS OF THE UNITED STATES
WASHINGTON, D. C. 20510

OTA Ocean Frontier Advisory Panel

John V. Byrne, Chair-
President, Oregon State University

Robert Bailey
Department of Land Conservation and
Development
State of Oregon

James Broadus
Director, Ocean Policy Center
Woods Hole Oceanographic Institute

Frank Busby
Busby Associates, Inc.

Clifton Curtis
President
Oceanic Society

Richard Greenwald
General Counsel
Ocean Mining Associates

Robert R. Hessler
Scripps Institution of Oceanography

Alex Krem
Vice President
Bank of America

John La Brecque
Senior Research Scientist
Lamont-Doherty Geophysical Observatory

Donna Moffitt
Office of Marine Affairs
State of North Carolina

J. Robert Moore
Department of Marine Studies
University of Texas

W. Jason Morgan
Department of Geological and Geophysical
Sciences
Princeton University

Jack E. Thompson
President, Newmont Mining Company

NOTE: OTA appreciates and is grateful for the valuable assistance and thoughtful critiques provided by the advisory panel members. The panel does not, however, necessarily approve, disapprove, or endorse this report. OTA assumes full responsibility for the report and the accuracy of its contents.

OTA Ocean Frontier Project Staff

John Andelin, *Assistant Director, OTA*
Science, Information, and Natural Resources Division

Robert W. Niblock, *Oceans and Environment Program Manager*

James W. Curlin, *Project Director*

Project Staff

Rosina M. Bierbaum, *Analyst*

James E. Mielke, *Specialist in Marine and Earth Sciences¹*

William E. Westermeyer, *Analyst*

Jonathan Chudnoff, *Research Assistant*

Elizabeth Cheng, *Stanford Summer Fellow*

Consultant

Francois Lampietti

Contractors

W. William Harvey, *Arlington Technical Services*

Edward E. Horton, *Deep Oil Technology, Inc.*

Lynn M. Powers

Richard C. Vetter

Administrative Staff

Kathleen A. Beil, *Administrative Assistant*

Jim Brewer, Jr., *P.C. Specialist*

Brenda B. Miller, *Secretary*

¹Congressional Research Service, Science Policy Division, Library of Congress.

Acknowledgments

We are grateful to the many individuals who shared their special knowledge, expertise, and information about marine minerals, oceanography, and mining systems with the OTA staff in the course of this study. Others provided critical evaluation and review during the compilation of the report. These individuals are listed in Appendix F in this report.

Special thanks also go to the government organizations and academic institutions with whom these experts are affiliated. These include:

U.S. Geological Survey:

- Office of Energy and Marine Geology
- Strategic and Critical Materials Program
- Western Regional Office, Menlo Park, CA

National Oceanic and Atmospheric Administration:

- Ocean Assessment Division
- Charting and Geodetic Services
- Office of Ocean and Coastal Resource Management
- Atlantic Oceanographic and Meteorological Laboratory

U.S. Bureau of Mines:

- Division of Minerals Policy and Analysis
- Division of Minerals Availability
- Bureau of Mines Research Centers—
 - Twin Cities, Minneapolis, MN
 - Salt Lake City, UT
 - Spokane, WA
 - Reno, NV
 - Avondale, MD

Minerals Management Service:

- Office of Strategic and International Minerals

We are particularly indebted to the Marine Policy Center, Woods Hole Oceanographic Institution, Woods Hole, MA, and the LaSells Stewart Center and Hatfield Marine Science Center of Oregon State University, Corvallis, OR, who graciously hosted OTA workshops at their facilities.

Contents

<i>Chapter</i>	<i>Page</i>
1. Summary, Issues, and Options	3
2. Resource Assessments and Expectations	39
3. Minerals Supply, Demand, and Future Trends	81
4. Technologies for Exploring the Exclusive Economic Zone	115
5. Mining and At-Sea Processing Technologies	167
6. Environmental Considerations	215
7. Federal Programs for Collecting and Managing Oceanographic Data	249
<i>Appendix</i>	<i>Page</i>
A. State Management of Seabed Minerals	282
B. The Exclusive Economic Zone and U.S. Insular Territories	292
C. Mineral Laws of the United States	300
D. Ocean Mining Laws of Other Countries	307
E. Tables of Contents for OTA Contractor Reports.	319
F. OTA Workshop Participants and Other Contributors.	322
G. Acronyms and Abbreviations.	330
H. Conversion Table and Glossary	332
Index	339

Chapter 1
Summary, Issues, and Options

CONTENTS

	<i>Page</i>
Exclusive Economic Zone: The Nation's New Frontier	3
Mineral Resources of the EEZ in Perspective	8
Mineral Occurrences in the U.S. EEL.	10
Minerals Supply, Demand, and Future Trends	13
Outlook for Development of Selected Offshore Minerals	15
Titanium	15
Chromate	15
Phosphorite	16
Gold.	16
Sand and Gravel	16
Deep-Sea Minerals	16
Technologies for Exploring the Seabed	17
Technologies for Mining and Processing Marine Minerals	19
Environmental Considerations.	20
Collecting and Managing Oceanographic Data.	21
Summary and Findings	23
Issues and Options	25
Focusing the National Exploration Effort	25
Providing for Future Seabed Mining...	28
Improving the Use of the Nation's EEZ Data and Information.. . . .	32
Providing for the Use of Classified Data	33
Assisting the States in Preparing for Future Seabed Mining	34

Boxes

<i>Box</i>	<i>Page</i>
1-A. The United Nations Convention on the Law of the Sea.. . . .	5
1-B. A Source of Confusion: Geologic Continental <i>Shelf</i> ; <i>Jurisdictional</i> Continental Shelf; Exclusive Economic Zone	7
1-c. Prelease Prospecting for Marine Mining Minerals in the EEZ: Minerals Management Service Proposed Rules	31

Figures

<i>Figure No.</i>	<i>Page</i>
1-1. The Ocean Zones, Including the Exclusive Economic Zone	4
1-2. U.S. Mineral Imports.	9
1-3. Potential Hard Mineral Resource in the EEZ of the Continental United States, Alaska, and Hawaii	11

Chapter 1

Summary, Issues, and Options

EXCLUSIVE ECONOMIC ZONE: THE NATION'S NEW FRONTIER

Ever since the research vessel H.M.S. *Challenger* hoisted manganese nodules from the deep ocean during its epic voyage in 1873, there has been persistent curiosity about seabed minerals. It was not until after World War II, however, that the black, potato-sized nodules like those recovered by the *Challenger* became more than a scientific oddity. The post-war economic boom fueled an increase in metals prices, and as a result commercial interest focused on the cobalt-, manganese-, nickel-, and copper-rich nodules that litter the seafloor of the Pacific Ocean and elsewhere. World War II also left a legacy of unprecedented technological capability for ocean exploration. Oceanographers took advantage of ocean sensors and shipboard equipment developed for the military to expand scientific ocean research and commercial exploration.

Over the last 30 years, much has been learned about the secrets of the oceans. Several spectacular discoveries have been made. For instance, only two decades ago, most scientists rejected the ideas of continental drift and plate tectonics. Now, largely due to research carried out on the oceanfloor, scientists know that the surface of the Earth is constructed of 'plates' which are in exceedingly slow but constant motion relative to each other. Plates pull apart along "spreading centers" where new crustal material is added to the plates; plates collide along "subduction zones" where old crust is thrust downward. While these plates move at rates of only a few inches per year, crustal material moves as if on a conveyor belt from spreading center to subduction zone. More recently, scientists have discovered that the seafloor spreading centers are zones where mineral deposits of potential use to humanity are being created. These sites of active mineral formation are often habitats for unique biological communities.

Scientists are excited by the new discoveries that have enabled them to better understand the Earth's structure and the processes of mineral formation, among other things. Other experts are more in-

terested in the implications of this new knowledge for potential financial gain. Nonetheless, despite the several decades of scientific research since World War II and some limited commercially oriented exploration, only the sketchiest picture has been formed about the type, quality, and distribution of seabed minerals that someday may be exploitable. A large part of the ocean remains unexplored, and this is almost as true of the coastal waters under the jurisdiction of sovereign states as it is of the deep ocean.

During the past three decades, many coastal nations have established Exclusive Economic Zones (so-called EEZs)—areas extending 200 nautical miles¹ seaward from coastal state baselines wherein nations enjoy sovereign rights over all resources, living and non-living (see figure 1-1). The EEZ concept has given new impetus to acquiring knowledge about the oceans and the inventory of mineral deposits within coastal nation jurisdiction. More than 70 coastal countries have now established Exclusive Economic Zones. When the United States established its own EEZ by Presidential proclamation in March 1983, it became the 59th nation to do so. Covering more than 2.3 million square nautical miles (nearly 2 billion acres, equivalent to more than two-thirds of the land area of the entire United States), the U.S. EEZ is the largest under any nation's jurisdiction.² Its international legal standing is based on customary international law, which has been codified in the Law of the Sea Convention (see box 1-A). Although the United States has thus

¹A nautical mile is 6,076 feet. All uses of the term "mile" in this assessment refer to a nautical mile.

²L. Alexander, "Regional Exclusive Economic Zone Management, in *Exclusive Economic Zone Papers*, Oceans 1984 (Washington, DC: Marine Technology Society, 1984), p. 7. Others have estimated the U.S. EEZ to be much larger—3.9 billion acres—but the larger estimate includes portions of the former Pacific Trust Territories that are no longer considered U.S. possessions (See W.P. Pendley, "America's Exclusive Economic Zone: The Whys and Wherefores, *Exclusive Economic Zone Papers*, Oceans 1984 [Washington, DC: Marine Technology Society, 1984], p. 43.)

³Law of the Sea Convention Article 55 et seq.

Figure 1-1.—The Ocean Zones, Including the Exclusive Economic Zone (EEZ)

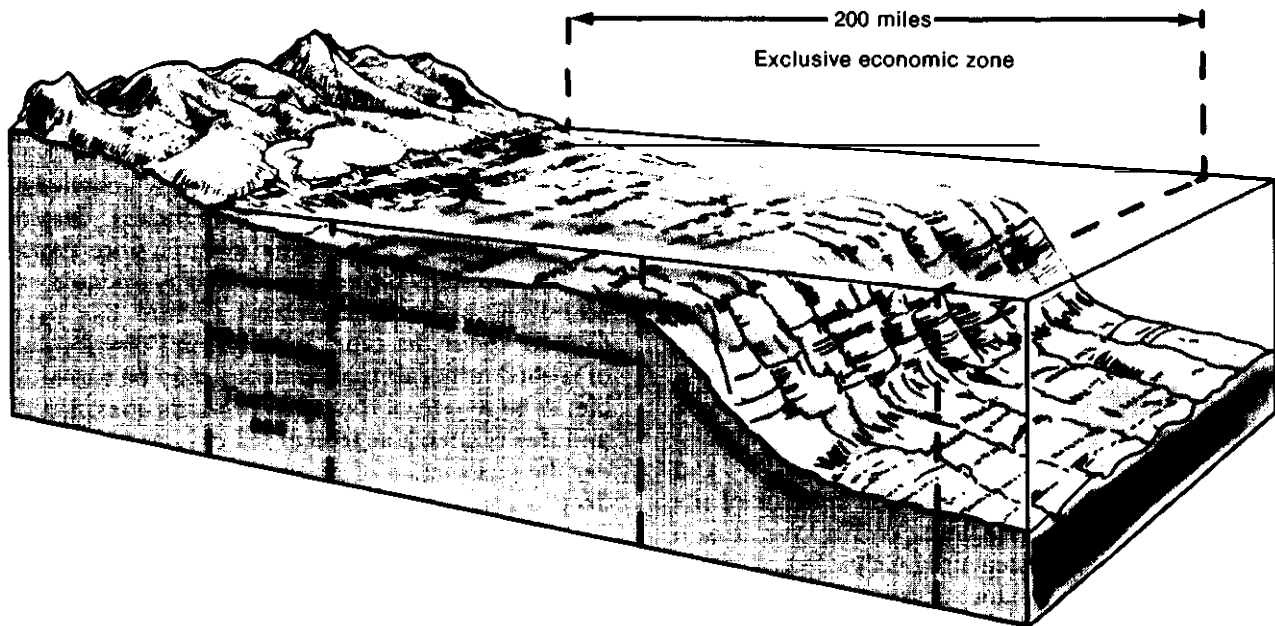

The Exclusive Economic Zone (EEZ) extends 200 nautical miles from the coast. Within the EEZ, the coastal States have jurisdiction over the resources in the 3-mile territorial sea*, and the Federal Government has jurisdiction over the resources in the remaining 197 miles.

● Except for Florida and Texas where State jurisdiction extends seaward 3 marine leagues (approximately 9 miles).

SOURCE: B. McGregor and M. Lockwood, *Mapping and Research in the Exclusive Economic Zone* (Washington, DC: U.S. Geological Survey and the National Oceanic and Atmospheric Administration, 1985), p. 3.

far declined to sign the agreement, the legal status of the U.S. EEZ is not in question. Like the EEZs of most other countries, the U.S. EEZ remains largely unexplored. It is the Nation's ocean frontier.

This assessment addresses the exploration and development of the U.S. territorial sea, continental shelf, and new EEZ, focusing on the mineral resource potential of these areas except for petroleum and sulfur. The known mineral deposits within U.S. waters are described; the capabilities to explore for and develop ocean mineral resources are evaluated; the economics of resource exploitation are estimated; the environmental implications related to seabed mining are studied; the contribution that seabed minerals may make to the Nation's resource base are examined; and the importance of seabed minerals relative to worldwide demand and to land-based sources of supply is assessed.

Unlike the sovereign control that governments have traditionally exercised over their territorial

possessions, control over the ocean and the utilization of its resources has been accommodated through intricate rules of international maritime law that have evolved since the 1600s. The Exclusive Economic Zone is an outgrowth of the Law of the Sea Convention—the most recent international effort to develop a more comprehensive law of the sea.

Within its EEZ, the United States claims “sovereign rights for the purpose of exploring, exploiting, conserving and managing natural resources, both living and non-living, of the seabed and subsoil and the superjacent waters. Each of the U.S. coastal States retains jurisdiction over similar resources within the U.S. territorial sea, a 3-nautical-mile band seaward of the coast, that was awarded to the States by Congress in the Submerged Lands Act of 1953.⁵ The interests of the coastal States in the 3-mile territorial sea and the responsibilities of the Federal Government in the administration of

⁴Executive Proclamation No. 5030 (1983).

⁵Public Law 83-31; 67 Stat. 29 (1953); 43 U.S.C. 1301-1315.

Box 1-A.—The United Nations Convention on the Law of the Sea

Comprising 320 articles and nine additional annexes, the 1982 Law of the Sea Convention (LOSC) is one of the most complex and comprehensive international agreements ever negotiated. Begun in 1973, the negotiations aimed to formulate international law covering a broad range of uses of the ocean and seabed. Eleven sessions were held between 1973 and the concluding session in 1982. Among the many law of the sea issues for which new rules have been devised or customary international law codified are:

1. innocent passage in the territorial sea,
2. transit of passages and innocent passage in international straits,
3. extension of coastal state jurisdiction on the continental shelf,
4. conservation and management of the living resources of the high seas,
5. the regime of islands,
6. enclosed or semi-enclosed seas,
7. land-locked states,
8. protection and preservation of the marine environment,
9. environment of ice-covered areas,
10. marine scientific research,
11. settlement of disputes,
12. exploitation of mineral resources in areas beyond national jurisdiction, and
13. exclusive economic zone.

The entire set of issues was negotiated as a package, an approach that called for trade-offs and compromise among the 150 or so countries participating in the Convention. As of early 1987, 32 countries had ratified the LOSC. The treaty will take effect one year after 60 countries have ratified it. Some believe that this number will be reached in 1989 and that the treaty therefore will be in force by 1990. However, the United States has not signed the Convention and currently has no plans to accede to it.

The principal objections of the United States to the Convention are the provisions pertaining to exploitation of mineral resources in the international seabed area, which are codified in Part XI. The United States objected to these provisions because, in its view, they would hamper future development of deep seabed mineral resources, the decisionmaking process would not give the United States a role that fairly reflected its interests, assured access to qualified seabed miners was not stipulated, and the mandatory transfer of private technology was required.* Most of the remainder of the Convention is acceptable to the United States, and all but a few provisions are considered to be customary international law.

Subsequent to the signing of LOSC, the Preparatory Commission was established to draft detailed regulations for the regime governing the exploitation of deep-sea mineral resources. The United States is eligible to attend the Preparatory Commission as an observer even though it has not signed the Convention. To date, it has not sent any official observers.

An alternative regime, known as the reciprocating state agreement, has been established by the United States and several other countries interested in seabed mining (some of whom are also signatories to LOSC). The principal purpose of the agreement is to ensure that disputes among signatories over possible overlapping claims can be amicably resolved.

*Statement by the President, press release July 9, 1982. See also *Law of the Sea: Implications for the Subcommittee on Oceanography and the Committee on Merchant Marine and Fisheries, House of Representatives, U.S. Congress, 97th Cong., 1st Sess., p. 173.*

the EEZ make the management of offshore resources a joint Federal-State problem.^c

As of July 1987, Congress had yet to enact implementing and conforming legislation to codify the

^cR. Bailey, "Marine Minerals in the Exclusive Economic Zone: Implications for Coastal States and Territories," White Paper, Western Legislative Conference, Pacific States/Territories Ocean Resource Group, Feb. 28, 1987, p. 32.

provisions of Executive Proclamation No. 5030, issued in 1983, which established the U.S. Exclusive Economic Zone except for reference in a few specific laws. The legislative task of implementing the EEZ Proclamation is not trivial. Reference to national ocean boundaries is contained in numerous statutes, and the impact on each must be considered carefully when amending laws to implement the new EEZ.

. the most important aspect of the Reagan Proclamation is its ceremonial declaration that the resources within the EEZ, . . . are declared to be held in trust by the U.S. Government for the American people.

Extension of U.S. control over the resources within the 200-mile EEZ in 1983 actually added—for practical purposes—little additional area to that already under the control of the United States. The U.S. and other coastal countries already had asserted control over fish within a 200-mile zone (under the Magnuson Fishery Conservation and Management Act of 1976⁷ and over other resources located on the continental shelves. This extended control over resources can be traced to the Truman Proclamation of 1945, in which President Harry Truman declared that the United States asserted exclusive control and jurisdiction over the natural resources of the seabed and the subsoil of the continental shelf.⁸ Many believe this proclamation was responsible for a flurry of new maritime claims. Following the proclamation, for instance, Chile, Peru, and Ecuador claimed sovereignty and jurisdiction out to 200 miles⁹ and considered the 200-mile zone to be wholly under their national control for all ocean uses except innocent passage of ships. Various other claims, but none quite so extensive, were asserted by other countries in the wake of the Truman Proclamation.

The United States implemented the Truman Proclamation by passage of the Outer Continental Shelf Lands Act in 1953. This act authorizes leasing of minerals in the continental shelf beyond

⁷Public Law 94-265 as amended. The Fishery Conservation and Management Zone extends seaward from the 3-mile State-controlled Territorial Sea and is contiguous with the EEZ. The seaward boundaries of Texas, Puerto Rico, and the gulf coast of Florida extend 9 nautical miles; all other States have a 3-mile seaward boundary.

⁸Executive Proclamation No. 2667; 59 Stat. 884 (1945).

⁹L. Alexander, "The Ocean Enclosure Movement: Inventory and Prospect," *San Diego Law Review*, vol. 20, No. 3, 1983, p. 564.

the State-controlled territorial sea.¹⁰ The unilateral action of the United States in extending jurisdiction over the petroleum-rich continental shelf led to an international agreement in 1958 (see box 1-B). As a result, all coastal nations acquired the rights to explore and exploit natural resources within the continental shelves adjacent to their coasts.¹¹

The area of the U.S. continental shelf is estimated to be approximately 1.6 million square nautical miles. Thus, a substantial proportion of the area of the recently proclaimed EEZ has been under the jurisdiction of the United States since 1945; mineral leasing on the Outer Continental Shelf has been authorized since 1953; and fisheries have been managed within the 200-mile Fishery Conservation and Management Zone since 1976. Hence, only mineral deposits in areas within 200 miles of the coast but beyond the continental shelf edge—the least accessible part of the EEZ—have been added to the resource base of the United States with the establishment of the new EEZ.

President Ronald Reagan's establishment of an Exclusive Economic Zone in 1983 kindled interest in the exploration of the "newly acquired" offshore province. Some likened the creation of the EEZ to the Louisiana Purchase. Others called for an EEZ exploratory venture akin to Lewis and Clark's exploration of the Northwest or John Wesley Powell's geological reconnaissance of the western territories in the 1800s. Perhaps the most important aspect of the Reagan Proclamation is its ceremonial declaration that the resources within the EEZ, whether on the seafloor or in the water column, whether living or non-living, whether hydrocarbons or hard minerals, are declared to be held in trust by the U.S. Government for the American people.

¹⁰Public Law 83-212, 67 Stat. 462 (1953), 43 U.S.C. 1331-1356; as amended Public Law 95-372, 92 Stat. 629 (1978), 43 U.S.C. 1801-1806.

¹¹1958 Convention on the Continental Shelf (UNCLOS), 15 UST 471; TIAS 5578.

Box 1-B—A Source of Confusion: Geologic Continental Shelf; Jurisdictional Continental Shelf; Exclusive Economic Zone

International and domestic law has established several ocean zones to accommodate the exploration and development of ocean resources. For instance, "Outer Continental Shelf" is used in the Outer Continental Shelf Lands Act to define the Federal offshore area in which mineral leasing is authorized. The legal entity "Outer Continental Shelf" is easily confused with the "continental shelf," which is a geologic subsea landform with scientific definition. Establishment of the Exclusive Economic Zone (EEZ) contributed more to the confusion. The EEZ overlaps both the jurisdictional Outer Continental Shelf and the geological continental shelf (figure 1-1). These overlapping zones seldom coincide exactly, and in some instances the geologic continental shelf may extend well beyond the 200-mile EEZ, while in other cases where the shelf is narrow it may extend only a few miles seaward, well short of the line of demarcation for the EEZ.

The Outer Continental Shelf Lands Act of 1953 defines Outer Continental Shelf as "all submerged lands lying seaward and outside of the area of lands beneath navigable waters . . . [three-mile State-controlled territorial sea] . . . , and of which the subsoil and seabed appertain to the United States . . ." A more precise definition of the continental shelf emerged from the international Convention on the Continental Shelf in 1958, which described it as extending from shore to a depth of 200 meters or beyond that limit to where the depth of the superjacent water admits of exploitation of the natural resources.

The 1958 international definition of continental shelf, therefore, is somewhat open-ended regarding the seaward extension of the shelf and bases the determination of the final outer boundary on technological capability to explore and exploit. The World Court has limited the extent of the continental shelf, at least in cases of boundary disputes, based on the notions of proximity and natural prolongation. Because the land is the legal source of a state's marine jurisdiction, it must be established that the submerged lands are in fact physical extensions of the state's territory.*

The United Nations Law of the Sea Conference, which concluded in 1982, established yet another international definition for the continental shelf. Article 76 of the Law of the Sea Convention (LOSC) defines it as the "sea-bed and subsoil of the submarine

areas that extend beyond its territorial sea throughout the natural prolongation of its land territory to the outer edge of the continental margin . . ." Where the "continental margin" extends beyond the boundary of the 200-mile EEZ, LOSC requires that signatory nations establish a finite outer limit based on formulae for determining where the foot of the continental slope meets the abyssal depths of the ocean. However, regardless of where such an outer point may lie as determined by formulae, the continental shelf can neither extend more than 350 nautical miles from the coast, nor exceed 100 nautical miles beyond the 8,200 foot isobath (point of equal water depth).

Since the United States is not signatory to the recent LOSC, the limitations imposed by Article 76 do not apply. Some legal analysts believe that the 1958 Convention on the Continental Shelf with its open-ended, technology-determined definition of the outer boundary of the shelf would apply unless Congress redefines its boundaries in subsequent EEZ implementing legislation. Under the more liberal 1958 interpretation, the Outer Continental Shelf could perhaps extend several hundred miles beyond the EEZ. According to this legal reasoning, with disagreement among legal analysts on the overlapping effects of the EEZ, the Outer Continental Shelf, the continental shelf within the meaning of the 1958 Convention on the Continental Shelf, and international ocean space beyond, there is the possibility that a legal "no-man's land" exists offshore where no domestic law governs.

The geological definition of the continental shelf is only slightly more precise than the several legal definitions. The *Dolphin Dictionary of Geological Terms* defines it as the "gently sloping, shallowly submerged marginal zone of the continents extending from the shore to an abrupt increase in bottom inclination; greatest average depth less than 600 feet, slope generally less than 1 to 1,000, local relief less than 60 feet, width ranging from very narrow to more than 200 miles." For scientific purposes, the definition is adequate since geologists can generally agree on where the continental shelf begins and ends. The industry seeking to explore and develop resources of the seabed and government administrators charged with managing the outer continental shelf have more difficulty in deciding the jurisdictional limits of the Outer Continental Shelf.

**North Sea Continental Shelf, 1969, I.C.J. 3.*

MINERAL RESOURCES OF THE EEZ IN PERSPECTIVE

The economic potential for seabed mining at this time is not favorable when compared to alternative sources of supply for most mineral commodities.

Knowledge about marine geology has steadily accumulated in recent years. Such knowledge has enabled scientists to revise their theories about the formation of some types of mineral deposits and to better predict where new deposits might be found. For instance, many continental features and mineral deposits were formed on or beneath the seabed. By studying the formation of mineral deposits on the oceanfloor, earth scientists are better able to understand geology on land. In the case of the formation of polymetallic sulfide deposits at seafloor spreading centers, mineral deposition can be observed as it occurs.

At the same time, knowledge of mineral deposits on land—gained through years of geological observation and research—provides clues about the nature and possible location of offshore minerals. For example, beach sand deposits containing heavy minerals (e. g., chromite or titanium) or phosphorites that were formed under the ocean before ancient seas receded may help identify the likely location and composition of similar deposits located in nearshore areas. Polymetallic sulfide deposits, now on shore but formed under the sea, have yielded large commercial quantities of copper, zinc, and lead ores. Knowledge about these onshore deposits may lead to better understanding of the evolution of polymetallic sulfide ores formed under the ocean.

Aside from the scientific knowledge that comparative studies of undersea and onshore mineral occurrences can provide, the potential for discovering sizable deposits of minerals on land or in the ocean as a result of seabed exploration could be important in the future. The economic potential of seabed mining at this time is not favorable when

compared to alternative sources of supply for most mineral commodities. However, onshore mineral deposits are finite, and, given sufficient economic incentives, even the higher cost seabed mineral deposits may become commercially viable—and perhaps attractive later.

Investment in seabed exploration and ocean mining technology should be considered a long-term venture. Its value cannot be gauged against either current economic conditions or present mineral demand. In the past, even short-term demand projections for mineral and energy resources have widely missed their marks. There is little reason to believe that supply and demand relationships will be any more predictable in the future. Today's overcapacity in many sectors of the minerals industry may give way to increased demand as populations expand and global economic growth resumes. On the other hand, changes in technology can also result in reduced demand for conventional mineral commodities through substitution, recycling, introduction of new materials, and miniaturization. Growth in minerals demand has been linked to world economic growth, and it is likely that the course of minerals consumption will continue to be affected by economic trends in the future.

Until more is understood about the location, extent, and characteristics of offshore minerals within U.S. jurisdiction, including their associated marine environment, the economic future of seabed minerals is mere conjecture. Their market position will be first determined by comparing their production costs with those of their closest domestic and foreign onshore competitors and next with competing foreign offshore producers. Minerals markets, as with most commodities, favor the least cost producers first, thus recognizing an economic pecking order among potential mineral sources. The determinants of minerals costs are dynamic and can change dramatically with the development of cost-saving technologies, discovery of exceptionally rich ore bodies, or erratic jumps in market prices as a result of increased demand or of supply disruptions. However, if environmental impacts could result from the mining or processing of seabed minerals,

Even though the occurrence of some minerals within the EEZ might have a dim economic future . . . , an understanding of their location, extent, and availability could provide an important cushion under emergency conditions.

then the cost of mitigating or avoiding damage to the marine environment must also be considered in determining economic feasibility of development.

The strategic importance of several minerals in the seabed—e.g., cobalt, chromium, manganese, and the platinum group metals—could make future economic considerations secondary to national

security. Between 82 and 100 percent of these critical metals are imported (figure 1-2) from countries with unstable political conditions or where other supply disruptions could occur for geopolitical reasons, e.g., the Republic of South Africa, the Soviet Union, Zimbabwe, Zaire, Zambia, China, Turkey, and Yugoslavia. Even though the occurrence of some minerals within the EEZ might have a dim economic future during normal periods, an understanding of their location, extent, and availability could provide an important cushion under emergency conditions. For shorter, less significant disruptions, the National Defense Stockpile could supplant the loss of some of the imported critical minerals on which the United States is dependent.

While the immediate challenge to the United States is to gain a better understanding of the physiography and geology of the seafloor and its envi-

Figure 1-2.—U.S. Mineral Imports

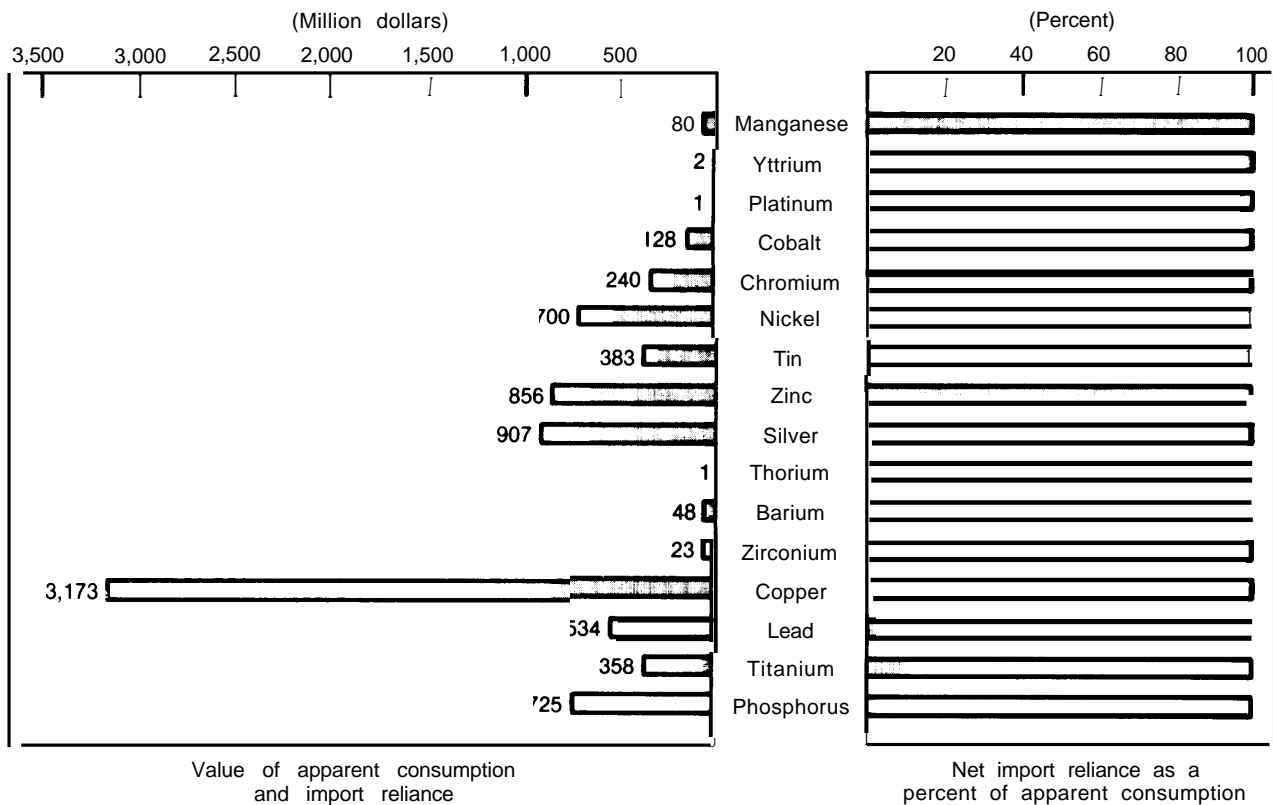

The United States is reliant on imports of a number of critical minerals that are known to occur on the seafloor within the 200-mile U.S. EEZ.

SOURCE: J.M Broadus and P. Hoagland, "Marine Minerals and World Resources," paper presented at the Marine Policy Center, Alumni Symposium, Woods Hole Oceanographic Institution, Woods Hole, MA, Apr 5.7, 1987 (modified).

At the current stage of preliminary resource assessment in the EEZ, little credence should be given to estimates of the economic value or tonnages of seabed minerals

ronment and to inventory minerals occurrences within U.S. jurisdiction, the potential value of developing and marketing technology for seabed mining and shipboard processing systems should not be ignored. It is possible—perhaps likely—that the

major commercial seabed mining ventures may not be in the U.S. Exclusive Economic Zone, but rather in other countries' waters (small mining operations have already taken place). In this instance, U.S. innovation and engineering know-how applied to developing seabed mining technology could place the United States in a pivotal competitive position to exploit a world market (probably modest in size) for seabed mining equipment. Technological innovation in seabed-mining systems could 'also assist the U. S. industry in maintaining a national capability to deploy such technology in U.S. waters or elsewhere in the world when economic opportunities arise or if emergencies occur.

MINERAL OCCURRENCES IN THE U.S. EEZ

Only a miniscule portion of the U.S. EEZ has been explored for minerals. However, several types of mineral deposits are known to occur in various regions of the U.S. EEZ (figure 1-3). These include:

- *Placers*—accumulations of sand and/or gravel containing gold, platinum, chromite, titanium, and/or other associated minerals.
- *Polymetallic Sulfides*—metal sulfides formed on the seabed from minerals dissolved in superheated water near subsea volcanic areas. They commonly contain copper, lead, zinc, and other minerals.
- *Ferromanganese Crusts*—cobalt-rich manganese crusts formed as pavements on the seafloor on the flanks of seamounts, ridges, and plateaus in the Pacific region. They may also contain lesser amounts of other metals such as copper, nickel, etc.
- *Ferromanganese Nodules*—similar in composition to ferromanganese crusts, but in the form of small potato-like nodules scattered randomly on the surface of the seafloor. Those found within the EEZ in the Atlantic Ocean tend to be lower in cobalt content than deep ocean manganese nodules in the Pacific Ocean.
- *Phosphorite Beds*—seaward extensions of on-shore phosphate rock deposits that were laid down in ancient marine environments.

Since so little is known about the volume in place and the mineral content (assay) of most seabed deposits, most deposits are properly termed "occurrences" rather than resources. Not much more can be said about a mineral occurrence other than that a mineral has been identified, perhaps in as little as one surficial grab sample. A few EEZ mineral deposits have been investigated enough to be termed 'resources, deposits that occur in a form and an amount that economic extraction is potentially feasible.

At the current stage of preliminary resource assessment in the EEZ, little credence should be given to estimates of the economic value or tonnages of seabed minerals that have been inferred by some observers. Current information should be interpreted cautiously to avoid implying a greater degree of certainty than is justified by the sampling density, sampling design, and analytical techniques used. Misinterpretation of the results (i. e., by inferring that the results of a small number of surficial samples are representative of an extensive, three-dimensional deposit) of preliminary assessments can lead to false expectations.

Close-grid, three-dimensional sampling is needed to adequately delineate and quantify mineral deposits in the seafloor. Sand and gravel, phosphorite beds, and placers vary in depth below the seabed

Figure 1-3.—Potential Hard Mineral Resources in the EEZ of the Continental United States, Alaska, and Hawaii

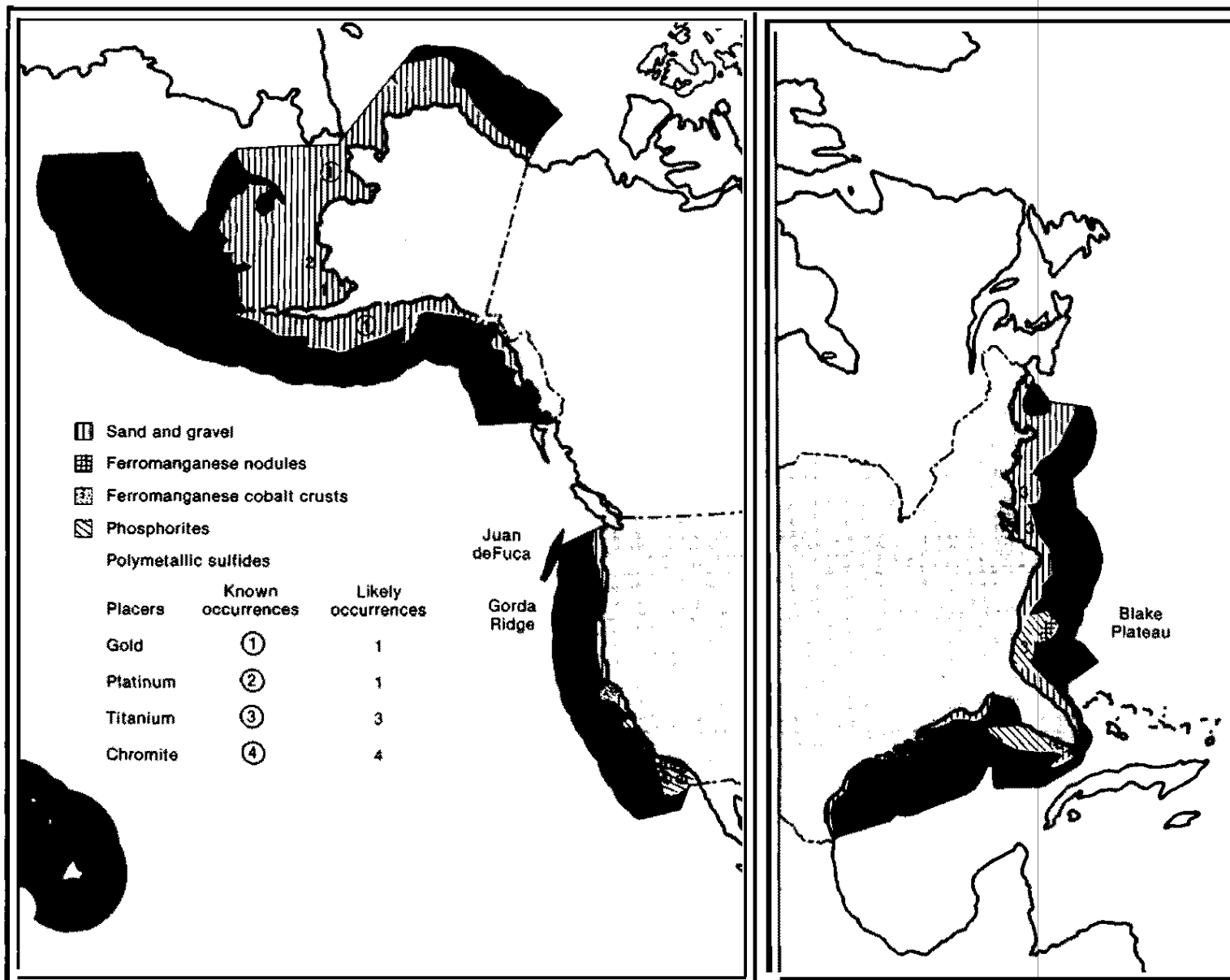

SOURCES: Strategic Assessment Branch, Ocean Assessments Division, Office of Oceanography and Marine Assessment, National Oceanic and Atmospheric Administration; Office of Technology Assessment; and S.J. Williams, U.S. Geological Survey.

To be competitive, marine minerals probably must either prove to exist in large, high-quality deposits, and/or to be cheaper to mine and process than their onshore counterparts.

and must be sampled by taking cores through many feet of sediment and sometimes down to bedrock. Sampling polymetallic sulfides is considerably more difficult than the other EEZ minerals. The thickness of polymetallic sulfide deposits is expected to be much greater, sometimes extending into the basement rocks of the seabed. Polymetallic sulfides are generally found in deeper water, and prohibitively expensive hard-rock coring techniques are required to adequately sample them. Resource assessments of cobalt-manganese crust deposits and manganese nodules are on somewhat firmer footing than placers or polymetallic sulfides. Nodule and crust distribution can be observed and visually mapped, while grab samples and shallow coring devices can assess the thickness of these deposits and obtain samples for chemical analysis.

More is known about sand and gravel than other hard mineral resources in the U.S. EEZ as a result of extensive sampling by the U.S. Army Corps of Engineers. Although onshore sand and gravel resources in most areas of the United States are ample to meet mainland needs for the near future, offshore deposits of high-quality sand may be locally important in the future, especially in New York and Massachusetts. Geologists have identified several offshore areas that have potential for hosting heavy mineral placer deposits, although data are still too sparse for compiling resource assessments. Occurrences of shallow-water mineral placer deposits have been identified in both State waters and the Federal EEZ.

One of the most promising areas for titanium sands and associated minerals in the U.S. EEZ is located between New Jersey and Florida. On the west coast, the best prospects for chromite placers,

Only a miniscule portion of the U.S. EEZ has been explored for minerals.

other associated minerals, and perhaps precious metals are offshore southern Oregon. In Alaska, gold is being investigated off the Seward Peninsula near Nome where some test mining has occurred, and platinum has been recovered onshore near Goodnews Bay on the Bering Sea, providing some evidence that precious metal placers may also lie offshore; in the Gulf of Alaska, lower Cook Inlet may be a promising area to prospect for gold.

Phosphorite beds located onshore in North Carolina and South Carolina extend seaward in the continental shelf. Extensive phosphorite deposits are found near the surface of the seabed in the Blake Plateau of the southeastern Atlantic coast, as well as off southern California.

Cobalt-rich ferromanganese crusts on the seabed adjacent to the Pacific Islands have piqued the interest of an international mining consortium. Data on the manganese crusts are insufficient to determine the resource potential, to identify a potential mining site, or to design a mining system. Ferromanganese nodules are located in the Blake Plateau and have been recovered in experimental quantities while testing deep seabed mining systems that were intended for use in the Pacific Ocean. The Blake Plateau nodules are in shallower water than those in the Pacific and thus may be more easily mined, but they have lower mineral content.

Polymetallic sulfide deposits located in the volcanically active Gorda Ridge in the U.S. EEZ and also located in the Juan de Fuca Ridge, that straddles the U.S.-Canadian EEZs off the Northwestern United States, have attracted considerable scientific curiosity. Although these deposits are known to contain large quantities of copper, lead, zinc, and other metals, uncertainties about the quality, composition, and extent of the deposits makes their resource potential difficult to determine.

MINERALS SUPPLY, DEMAND, AND FUTURE TRENDS

Commodities, materials, and mineral concentrates—the stuff made from minerals—are traded in international markets. There is nothing special or unique about marine minerals that makes them different from those obtained domestically onshore or from foreign sources. They must, nevertheless, compete for price, quality, and supply reliability with other foreign and domestic mineral suppliers. To be competitive, marine minerals probably must either prove to exist in large, high-quality deposits, and/or to be cheaper to mine and process than their onshore counterparts. Major questions remain as to where marine minerals may fit in the future economic pecking order of producers.

The commercial potential of marine minerals from the U.S. EEZ is uncertain because development, when it occurs (or if it occurs in the case of some minerals), is likely to be in the distant future. It is difficult to foresee the future of marine minerals for several reasons:

- Little is known about the extent and grade of the mineral occurrences that have been identified in the EEZ.
- Little actual experience and few pilot operations are available to evaluate seabed mining costs and operational uncertainties.
- Erratic performance of the domestic and global economies adds uncertainty to forecasts of minerals demand.
- Changing technologies can cause unforeseen shifts between demand and supply of minerals and materials.
- Past experience indicates that methods for projecting or forecasting minerals demand are not dependable.

Materials are constantly competing with one another for applications in goods and industrial processes. Total consumption of a mineral commodity is determined by the amount (volume or number) of goods consumed and by the amount of a commodity used in manufacturing each unit. The former is linked to the vitality of the economy and customer preference, while the latter is related to technological trends which also may be related to economic factors. Substitution of new or different materials, conservation through more efficient

manufacturing, and recycling of used materials can reduce the demand for virgin materials.

Major changes in domestic and world economies, coupled with technological advancements and changes in consumer attitudes, have significantly altered consumption trends beginning in the late 1970s and continuing through the present. For most of the commodities derived from marine minerals, the amount used relative to the goods produced has decreased for chromium, cobalt, manganese, tin, zinc, lead, and nickel from 1972 to 1982. Only platinum and titanium increased in use intensity. Consumption of goods and consequently the demand for mineral commodities used to produce the goods—with the exception of platinum and titanium—also decreased (but less abruptly than use intensity) during the same period,

Mining capacity increased—particularly in the mineral-rich Third World—in the early 1970s when mineral prices were high, consumption strong, and the economic outlook bright. In the 1980s, demand softened, prices dropped, and the world economy slowed, causing significant excess world mining capacity for most of the minerals that occur in the U.S. EEZ. It is unknown whether technological trends toward miniaturization, substitution, and lower intensity of use of the commodities derived from marine minerals will continue in the future, or whether domestic and world economic growth will rebound to new heights or merely continue sluggishly on the current course. These uncertainties will affect the utilization of existing capacity and determine the need for new mineral development in the future, including minerals from the seabed.

As a result of excess world capacity, the U.S. minerals and mining industry has met with substantial foreign competition. Metals prices remain low, and, until recently, production costs in the United States and Canada have been well above the world average for copper, zinc, lead, and other metals used in large industrial quantities. Competition from low-cost foreign producers, with advantages of lower capital and operating costs and higher grade ores, have resulted in a depressed domestic

mining industry, a trend that accelerated in the early 1980s.

Foreign producers, including state-owned or state-controlled companies, are likely to continue to be the measure of competition that must be met by both domestic onshore and offshore producers. Only when seabed mine production is the least cost source with respect to both domestic and foreign onshore producers and even foreign offshore producers will it become commercially viable.

Manganese, chromium, and nickel are alloying elements that are used to impart specific properties to steel and other metals. Their demand is closely tied to the production of steel; they are usually added to molten metal as a ferroalloy or as an intermediate product of iron enriched with the alloying element. There are no domestic reserves (proven economic resources) of manganese or chromium; therefore, the United States must import substantially all of these alloying metals.

A decade ago, concentrated ores were imported for conversion to ferromanganese and ferrochromium by U.S. ferroalloy firms to supply a then-robust domestic steel industry. Since 1981, the United States has imported more finished ferrochromium than it has chromite ore, and a similar pattern has developed with ferromanganese. Foreign producers now supply U.S. markets with about 90 percent of the ferrochromium consumed for the domestic manufacture of chromium steel. Chromite-producing countries are now converting ore to finished ferroalloy and gaining the value added through the manufacturing process before exporting to consumers. There is currently no existing domestic capacity to produce ferromanganese.

U.S. steel production has also declined in favor of cheaper imports. With decreases in both U.S. ferroalloy production and iron and steel production, demand for chromium and manganese ores (manganese is also used to desulfurize steel) for domestic ferroalloys is likely to continue to diminish. The United States is fast approaching total dependence on foreign processing capacity of ferroalloys. Even if EEZ chromite heavy sands off southern Oregon were to prove economically recoverable,

there are no ferroalloy furnaces in the Pacific Northwest to process the chromite produced. Any offshore chromite recovered probably would be used for the production of sodium bichromate, the major chemical derivative of chromium.

Titanium metal is used extensively in aerospace applications, and its use in industrial applications is expected to expand in the future. Heavy mineral sands in the EEZ off the Southeastern Atlantic States contain substantial concentrations of ilmenite, a titanium-bearing mineral. Although ilmenite can be converted to titanium metal through an intermediate process (alteration to synthetic rutile), the added expense might make it uneconomical. The most probable use for ilmenite recovered from the Atlantic EEZ would be as titanium pigments, since two major plants currently operate in northern Florida using locally mined onshore minerals; over 30 percent of world's titanium pigment production is in the United States.

About 90 percent of the phosphate rock mined in the United States goes for the production of agricultural fertilizers. Most of the remainder is used to manufacture detergents and cleaners. Phosphate is abundant throughout the world, but only a small proportion is of commercial importance. Offshore phosphorites are similar to those that are mined in the coastal plain onshore. The United States historically has been the leading producer of phosphate rock, but its preeminence is now challenged by cheaper foreign producers.

Precious metals—gold, platinum-group—are in a class of their own. By definition, they are less abundant and more difficult to find and recover than other minerals, hence their enhanced value. Both are used to some extent in manufacturing, the platinum-group metals are used most widely. Demand for the platinum-group is expected to increase in the future as Europe, Australia, and Japan adopt automobile emission controls that use platinum as a catalyst. Gold remains a standard of wealth, and is used for jewelry. Both platinum and gold are subject to the whims of speculators who respond to anticipated economic changes, market trends, world political conditions, and other factors; therefore, prices can change abruptly and unpredictably.

OUTLOOK FOR DEVELOPMENT OF SELECTED OFFSHORE MINERALS

OTA has assessed the potential for near-term development of selected minerals found within U.S. coastal waters. Costs of offshore mining will determine its competitive position with regard to onshore sources of the same minerals in the United States and abroad. For most offshore minerals, the near-term prospects for development do not appear promising. Although only minor new developments in technology will be required to mine offshore placer deposits or phosphorite, costs for offshore mining equipment are likely to be higher than capital costs for onshore operations. Some of the factors that will increase costs include the need for seaworthy mining vessels and possible requirements for motion compensating devices and navigational and positioning equipment.

In addition to greater capital costs, operating costs for offshore mining typically will be higher than for onshore operations. Occasional adverse weather conditions will undoubtedly reduce the number of days per year during which mining is feasible. For most offshore settings, mining rates of 300 days per year are considered optimistic. The necessity of transporting to shore (possibly great distances) either raw or beneficiated ore for final processing is another factor that may increase operating costs relative to costs for onshore operations. On the other hand, siting offshore mining equipment is easier and less expensive than for onshore facilities.

Sufficient data are not available with which to make detailed cost estimates of typical future offshore mining operations. However, first approximations of profitability can provide insights into the competitiveness of offshore relative to onshore mining. OTA has developed mining scenarios for four types of hypothetical marine mineral deposits in areas where concentrations of potentially valuable minerals are known to occur. The deposits evaluated include titanium-rich sands off the Georgia coast, chromite-rich sands off the Oregon coast, phosphorite off the North Carolina and Georgia coasts, and gold off the Alaska coast near Nome.

Titanium

OTA's analysis of offshore titanium sand mining indicates that it is not very promising in the near term. Nevertheless, there has been some commercial interest shown in these deposits. The recovery of ilmenite alone from an offshore placer does not appear economically feasible and will not be feasible unless primary concentrate can be delivered to an onshore processing plant at costs comparable to those incurred in producing the equivalent titanium minerals from an onshore placer deposit. To be competitive, the offshore deposit would have to contain considerable amounts of higher valued heavy minerals like rutile (valued at \$350 to \$500 per ton) or other more valuable minerals, e. g., zircon, monazite, or precious metals. Such deposits have not yet been identified.

Chromite

Mining and processing chromite-rich sands show results similar to those obtained for titanium. For chromite, revenues of about \$125 per ton would be required to realize a 3-year payback on investment. The average price of low-grade, nonrefractory chromite concentrate imported into the United States during the first half of 1986 was \$40 per ton, exclusive of import duties, freight, insurance, and other charges. Production of chromite alone, therefore, would not meet revenue requirements. The presence of higher valued minerals, such as gold, could improve the profitability of mining offshore chromite sands if revenues from the sale of coproducts exceeded the costs of their separation.

With excess capacity in the world's ferroalloy industry, it is unlikely that a viable U.S. ferrochromium installation could survive foreign competition. It is possible that the Oregon chromite sands might be used for the manufacture of sodium dichromate, the major industrial chromium chemical. A west coast "green field" plant probably would have to be built for this purpose to offset the transportation costs of shipping to existing east coast chemical plants.

Phosphorite

The economic outlook for offshore phosphorite mining is not especially promising either. In the past, the United States led world phosphate rock production with onshore mining in northern Florida and North Carolina; now the United States is being challenged by Morocco, which has immense high-grade reserves judged to be capable of satisfying world demand far into the future. The prospect that mining of U.S. offshore phosphorites could successfully compete with low-cost Moroccan phosphate rock or other possible low-cost foreign producers is considered remote. However, domestic onshore producers have met considerable opposition because of potential environmental disturbance and land use conflicts. The offshore marine deposits of North Carolina and other Southeastern States might become more competitive with domestic onshore production in the future if environmental and land use problems become insurmountable.

Gold

Offshore gold placer mining near Nome, Alaska, appears more promising. In fact, Inspiration Mines has already undertaken pilot mining and is planning to begin full-scale gold mining with a converted tin dredge from southeast Asia. Some of the data OTA used in estimating capital and operating costs for this project were provided by Inspiration Mines; thus, some of the assumptions used in the gold offshore mining scenario are considered more reliable.

Assuming the price of gold to be \$400 per ounce (a conservative assumption in July 1987, but the price of gold is subject to wide swings), the projected pre-tax cash flow on the estimated production of 48,000 ounces of gold per year would be approximately \$19 million. This figure indicates that the offshore gold mining project at Nome shows good promise of profitability if the operators are able to maintain production. Note, however, that offshore mining will be possible only about 5 months per year, because ice on Norton Sound prohibits operations during the winter months. The duration of yearly ice cover (as well as the fluctuating price of gold) will have a significant effect on the profitability of this operation.

With the exceptions of sand and gravel and precious metals, the commercial prospects for developing marine minerals within the EEZ appear to be remote for the foreseeable future.

Sand and Gravel

The least valuable marine minerals by volume are sand and gravel. However, these resources may have the most immediate competitive position in relation to onshore supplies. Although onshore sand and gravel resources are immense, coarse sand is sometimes hard to find and land use restrictions increasingly prohibit access to suitable resources. Some limited offshore mining of sand and gravel is taking place. Sand and gravel is a high-volume, low-value commodity where short-haul transportation is important. Around high-growth, high-density areas in the Northeast and on the west coast, marine sand and gravel might soon prove profitable to mine.

Deep-Sea Minerals

OTA did not estimate the potential for near-term exploitation of ferromanganese nodules, cobalt-rich ferromanganese crusts, or polymetallic sulfides. Recovery of ferromanganese nodules (which include copper, nickel, and manganese) from the deep seafloor beyond the U.S. EEZ has been studied by the industry, the National Oceanic and Atmospheric Administration (NOAA), and the Minerals Management Service (MMS). Prototype technology has been designed and tested, but plans to mine nodule resources in the central Pacific Ocean have been on hold pending favorable economic conditions.

Even less is known about the economic potential for recovery of cobalt-rich crusts (within the Hawaiian EEZ) or polymetallic sulfide deposits (within the U.S. EEZ off Oregon and northern California) than about the potential for recovery of nodule or placer deposits. Technology has not yet been developed for mining these deposits nor does sufficient information about the nature of the deposits

The job of exploring the U.S. EEZ is immense, difficult, and expensive . . . [it] is not an activity that is likely to be undertaken by the private sector in response to market forces.

exist to permit meaningful estimates of future economic potential to be made, More data about the physical characteristics of cobalt crusts and poly-metallic sulfides are needed before mining concepts can be refined and mining costs estimated. An international consortium is studying the potential for mining cobalt-rich crusts in the Johnston Island EEZ, but near-term incentives for mining crusts and sulfides do not exist.

It is risky to attempt to rank the future potential for development of marine minerals in the EEZ because of shortfalls in resource data. Nevertheless, an assessment based on what is known of the nature and extent of the mineral occurrences, coupled with insights into mineral commodity markets and trends, suggests the following rank “estimate” for the probable order of development:

1. sand and gravel
2. precious metal placers,
3. titanium and chromite placers and phosphorite,
4. ferromanganese nodules,
5. cobalt-rich ferromanganese crusts, and
6. polymetallic sulfides.

TECHNOLOGIES FOR EXPLORING THE SEABED

The job of exploring the U.S. EEZ is immense, difficult, and expensive. The job is not an activity that is likely to be undertaken by the private sector in response to market forces. In its initial reconnaissance stages, it is largely a government responsibility. As knowledge narrows the targets of opportunity to those of economic potential, commercial interest may then motivate entrepreneurs to explore in more detail. But without the first efforts by the Federal Government, both the scientific community and industry will be unable or unwilling to launch an effective, broad-scale exploration program.

Technological capabilities for exploring the seabed in detail are currently available and in use. These range from reconnaissance technologies that provide relatively coarse, general information about very large areas to site-specific technologies that provide information about increasingly smaller areas of the seafloor. A common strategy is to use these technologies in the manner of a zoom lens, that is, by focusing on progressively smaller areas with increasing detail.

Among the reconnaissance technologies available are echo-sounding instruments capable of accurately determining the depth of the seafloor and

producing computer-drawn bathymetric charts showing the form and topography of the bottom. Side-looking sonar devices produce photo-like images that can reveal interesting features and patterns on the seafloor. These technologies can be combined in one piece of equipment or used simultaneously to survey broad swaths of the seafloor while a vessel is underway, thus providing near-perfect registry between the sonar and bathymetric data. Broad-scale coverage of side-looking sonar imagery for most of the U.S. EEZ soon will be available from the U.S. Geological Survey (USGS). However, high-resolution, multi-beam bathymetric data collected by NOAA will take much longer to acquire. Moreover, the future of NOAA’s bathymetric charting program is uncertain, since the Navy considers the data to be of sufficient quality to classify for national security reasons.

Seismic technologies, which are used extensively by the offshore petroleum industry, can detect structural and stratigraphic features below the seabed which can aid geological interpretation. New three-dimensional seismic techniques, although very expensive, can enhance the usefulness of seismic information. Gravimeters can detect differences in the density of rocks, leading to estimates of crustal rock types and thicknesses. Magnetometers provide

The military value of some EEZ data might require restrictions on access and use of certain information for national security reasons.

information about the magnetic field and may be used offshore to map sediments and rocks containing magnetite and other iron-rich minerals. Both of these technologies are also used for oil and gas exploration. Data can be collected rapidly by moving vessels and stored in retrievable form.

Other technologies may also be used to explore the EEZ. Some, like many electrical techniques, are proven technologies for land-based exploration which have been adapted for ocean use, but have not been widely tested in the marine environment. Induced polarization, for example, has potential for locating titanium placer deposits and for performing rapid, real-time, shipboard analyses of core samples. Nuclear techniques may also prove useful for identifying such minerals as phosphorite, monazite, and zircon that emit radiation.

When the focus of attention narrows to prospective targets of interest on the seafloor, direct visual observation is often useful. Manned submersibles and/or remotely operated undersea vehicles (ROVs), similar to those used for locating the Titanic in 1986, may come into play. Remotely operated cameras capable of observing, transmitting, and recording photographic images have proved valuable exploration tools.

Direct sampling of seabed minerals for assessment presents special problems. In some cases, it is possible (as has been done with the research submersible Alvin to recover limited samples of seabed minerals using manned submersibles or ROVs). A number of devices have been developed to retrieve a sample of unconsolidated sediment, but few are capable of extracting undisturbed samples that reflect the mineral concentrations contained in the

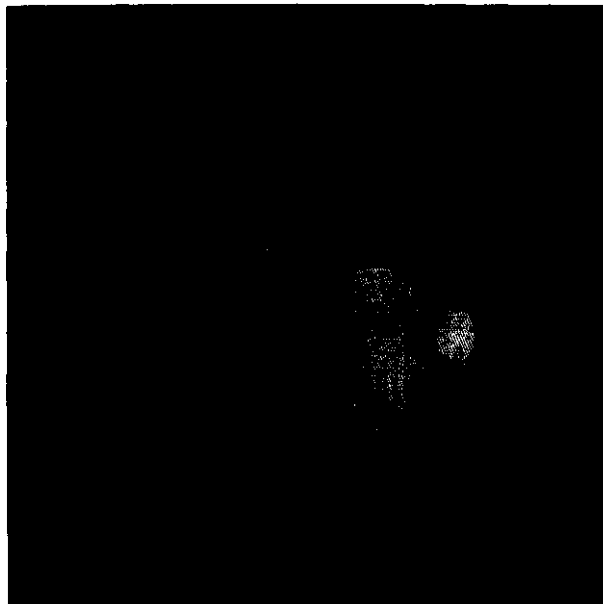

M
 m d bm b A p d d
 w a e w
 m m d m
 9 0

seabed deposit. Many of the sediment coring devices were designed for scientific use, and few are capable of economically and efficiently recovering the large number of samples that are needed to accurately determine the commercial feasibility of a refine mineral deposit and to delineate a mine site.,

Quantitative sampling of hard-rock deposits, e.g., ferromanganese crusts and polymetallic sulfides, is economically infeasible with existing technology. While large drill ships (e. g., the *Joides Resolution*) used in the Ocean Drilling Project or those used by the offshore petroleum industry, are capable of drilling and extracting cores from hard basaltic rock, their cost is prohibitive for extensive, high-density sampling of the kind needed to assess a mineral deposit. It may prove easier to develop a practical sampling device for thin ferromanganese crusts than for the thicker, less regular, polymetallic sulfides.

TECHNOLOGIES FOR MINING AND PROCESSING MARINE MINERALS

Existing or modified dredge mining systems could place many potential placer deposits in the range of technical exploitability.

From table-flat, heavy mineral sand placers deposited in shallow water to mounds and chimneys of rock-like polymetallic sulfides at depths of over a mile, marine minerals present a variety of challenges to the design, development, and operation of marine mining systems. Development and capital costs for vessels and marine systems can be high. Profitability of offshore mining ventures will hinge on whether safe and efficient mining systems can be built and operated at reasonable costs. With the exception of conversions of onshore dredge mining equipment for shallow, protected water offshore and work done on deep seabed manganese nodule mining systems, there has been little development effort thus far.

Dredge mining technology is used extensively for harbor and channel dredging in coastal waters and for onshore mining of phosphate rock and heavy mineral sands. It has also been used for mining tin in coastal waters in Asia and is currently being used in pilot mining of gold in State waters near Nome, Alaska.

In deeper waters subject to winds, waves, swells, and currents, specially designed mining dredges must be developed. High endurance dredges for deep waters must be self-powered, seaworthy plat-

forms with motion compensating systems and may be equipped with onboard mineral processing plants and storage capacity. Conceptual designs of such equipment are being readied. The design of even the most sophisticated dredge probably can be achieved without major new technological breakthroughs. Cost will be the most important limiting factor.

The maximum practical operating depth for most dredging systems is about 300 feet from the surface of the water to the bottom of the excavation on the seafloor. Airlift systems can be used on suction dredges to lift unconsolidated material from much greater depths. Existing or modified dredge mining systems could place many potential placer deposits in the range of technical exploitability.

Solution or borehole mining has been tested in north Florida land-based phosphate rock deposits as a means to reduce surface disturbance and environmental impacts. The technique involves sinking a shaft into the phosphorite deposit, jetting water into the borehole, and pumping the resulting slurry to the surface. Although the technique has not yet been tested under marine conditions, some mining engineers speculate that it could have potential for offshore phosphorite mining.

Several preliminary mining systems have been sketched out for recovering ferromanganese crusts as well as for mining polymetallic sulfide deposits, but little if any development work has proceeded in either area. Collection and airlift recovery systems developed for deep seabed manganese nodules may be adaptable to mining both crusts and polymetallic sulfides. Too little is known about the

DREDGES WHICH OPERATE HYDRAULICALLY



DREDGES WHICH OPERATE MECHANICALLY

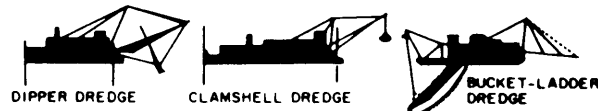

Dredge Technologies

Dredge technologies are well developed and proven through years of experience. Adaptation of inshore dredge mining systems for offshore use could make the technical exploitability of some heavy mineral placer deposits possible if seabed mining is found to be economically competitive.

Source: Office of Technology Assessment, 1987

nature and extent of the deposits to allow the development of prototype mining systems at this time.

Mineral processing technology has evolved through centuries of experience with onshore minerals, although such techniques have not been widely applied at sea. No major technological breakthroughs are considered to be needed to adapt onshore processing technologies to shipboard use, but considerable uncertainty remains about the costs and efficiency of operating a minerals processing plant at sea.

Shore-based v. at-sea minerals processing will be a trade-off that a seabed mining enterprise must consider. If shipboard processing is installed, it may be cheaper to transport smaller amounts of high-grade processed ore (beneficiated) than to haul large volumes of unprocessed ore containing as much as 85 to over 90 percent waste material to an onshore processing plant. Economic conditions that would influence such a decision could vary for each case.

ENVIRONMENTAL CONSIDERATIONS

Little direct experience exists with commercial offshore mining with which to estimate the potential for environmental harm.

Little direct experience exists with commercial offshore mining with which to estimate the potential for environmental harm. Even channel and harbor dredging operations or recovery of sand for beach nourishment, which have been studied in some detail, are sporadic operations and do not reflect the impacts that could result from long-term placer dredge mining operations that would move considerably more material from a larger area of the seafloor. Less is known about impacts to deep water environments than shallow water environments.

Physical disturbance from dredge mining operations will consist of removing a layer of the seafloor, conveying it to the surface, and reinjecting the unwanted material onto the seabed. The mining operation will generate a transient "plume" of sediment that will affect the surface, the water column, and adjacent areas of the oceanfloor for an uncertain period of time.

Experience with sand and gravel mining in Europe and with the dredging operations of the U.S. Army Corps of Engineers suggests that as long as sensitive areas (e. g., fish spawning and nursery

grounds) are avoided, surface and mid-water effects from either shallow or deep water mining should be minimal and transient. Benthic communities assuredly will be destroyed if mined, and some nearby areas may be adversely affected by sediment returning to the seafloor. However, mining equipment can be designed to minimize such damage, and, except where rare animals occur, entire benthic populations are eliminated, or the substrate is permanently altered, the seafloor should recolonize. Recolonization is expected to take place quickly in high-energy, shallow water communities, but very slowly in deep-sea areas. If any at-sea processing of the mined material occurs—with subsequent discharge of chemicals—negative impacts would possibly be more severe.

It is not scientifically or economically feasible to research ecological baseline information on all of the marine environments that may be affected by seabed mining. Furthermore, the consequences of the range of possible mining scenarios are unknown. Anticipating and avoiding high-risk, sensitive areas and mitigating damage through improved equipment design and operating procedures can reduce the impacts from offshore mining. Environmental monitoring during the mining process will provide an additional margin of safety and add to the knowledge of what effects seabed mining might have on the marine environment as well. Concurrent observations in undisturbed control areas similar to those being mined could also provide an understanding of the processes at work.

Anticipating and avoiding high-risk, sensitive areas and mitigating damage through improved equipment design and operating procedures can reduce the impacts from offshore mining.

What effects might extensive mining in shallow waters have on the coastline? The removal of large quantities of sand and gravel or placers in near-shore areas might alter the coastline and aggravate coastal erosion by altering waves and tides. Experience with sand removal off Grand Isle, Louisiana, for beach replenishment suggests that the mining of even small areas to substantial depths may cause serious damage to the shoreline. This potential problem requires considerably more investigation.

More, too, should be learned about the structure and energetic of deep-sea communities. However, to do so requires expensive submersibles and elaborate sampling equipment because of the difficulty of operating at great depths.

A considerable amount of environmental data already has been collected by a number of Federal agencies as part of their missions. Much of the information remains in the files of each agency, and only a small part finds its way into the public literature. Some of this environmental information could be useful in planning offshore mining operations. The public investment in such environmental information represents hundreds of millions



red
 m w g
 m mm m gm g
 m
 d llar A add al m d m m
 p mp d m d h h m
 b h S h p dp b d
 h mm w d h

COLLECTING AND MANAGING OCEANOGRAPHIC DATA

Several Federal agencies share responsibility for exploring various aspects of the U.S. EEZ. In addition, coastal States, oceanographic institutions, academic institutions, and private industry also contribute information and data about the Nation's offshore areas. All of these institutions, except the private firms, are funded primarily with public funds. The overall investment in collecting oceanographic data related to exploring the EEZ is not trivial, nor are the problems of coordinating exploration efforts and archiving the results.

At a time when the Federal Government is struggling to reduce the Federal budget deficit, it is important to ensure that Federal agencies coordinate their complementary and overlapping functions and promote a spirit of cooperation among investigators that will encourage efficiency and responsibility. With regard to EEZ exploratory programs, there have been notable and unprecedented achievements in cooperation and communication between the Department of the Interior (DOI) and NOAA during the last few years. USGS and NOAA have

agreed to a division of effort in EEZ exploration and have taken steps to create a joint office to take the lead in integrating information from government and private sources. However, the Minerals Management Service, with responsibility for managing the Outer Continental Shelf mineral resources, and the Bureau of Mines, with responsibility for mining and minerals research and investigations, are not formally linked to the USGS-NOAA cooperative agreement.

About a dozen Federal agencies administer programs related to the exploration and investigation of the EEZ. The oceanographic and resource data produced by the numerous Federal programs and augmented by similar data collected by States, industry, and academic institutions make up an impressive body of information. The data sets are of highly variable quality and were collected in different places over different time periods. Some of these data are available to other researchers and the public through formal and informal exchanges among the institutions; other data, however, are less accessible.

As exploration of the EEZ increases in intensity, data management problems will worsen. Modern instruments, such as multi-beam echo-sounders, satellites, and multi-channel seismic reflection recorders, produce streams of digital data at high rates of speed. To succeed, a national exploration effort in the EEZ must effectively deal with the problems of compiling, archiving, manipulating, and disseminating a range of digital data and graphic information. Historically, Federal agencies have spent proportionately more on collecting the data than on archiving and managing databases compared to their counterparts in the private sector. Industry managers consider data collected in the course of investigations to be capital assets with future value; in general, the Federal agencies seem to consider data more as an inventory of limited long-term value and hence have spent less on data management.

There is no governmentwide policy for archiving and disseminating oceanographic data to secondary users. The National Science Foundation's Ocean Sciences Division has taken steps to ensure that data collected in the course of research it funds are submitted to NOAA's National Environmental

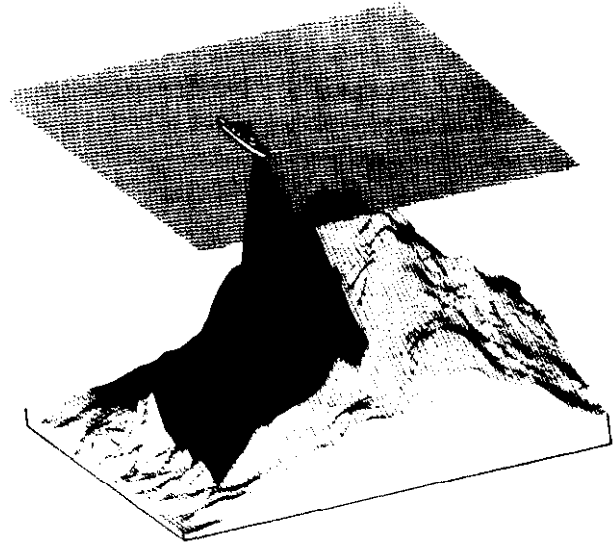

Modern multi-beam echo-sounding systems and computer mapping technologies can produce accurate topographic maps of the deep seabed. Mapping is the first step toward a systematic program for exploring the EEZ.

SOURCE: Naval Research Laboratory

Satellite, Data, and Information System. There are two national data centers that act as libraries for oceanographic and geophysical data: 1) National Oceanographic Data Center, and 2) National Geophysical Data Center. Both are managed by NOAA. Data at the centers are acquired from Federal agencies under interagency agreements; some agencies are more responsive and reliable in forwarding data to the centers than are others.

Funds for the centers have never been adequate to provide effective oceanographic data services to secondary users in industry, academia, or State governments. As a result of chronically inadequate funding, the centers are neither able to acquire existing data sets that have intrinsic historical baseline value nor to preserve and store but a relatively small proportion of the new data that are currently being produced. Oceanographic data discarded for lack of storage facilities is a government asset lost forever.

Detailed charts of the seafloor, such as those produced by multi-beam echo-sounding instruments (e.g., Sea Beam), are considered to be invaluable tools for geologists and geophysicists exploring the

EEZ. Unfortunately, they are also considered to be invaluable tools for navigating and positioning potential hostile submarines within the EEZ. As a consequence, the U.S. Navy has taken steps to classify and restrict the public dissemination of high-resolution bathymetric charts produced by NOAA's National Ocean Services in the EEZ.

NOAA's plans for exploring the EEZ include broad-scale, atlas-like coverage of the EEZ with high-resolution bathymetry. The plan is applauded by the academic community, but the Navy, concerned about the national security implications of public release of such data, opposes NOAA's plan unless security can be assured. Negotiations between NOAA and the Navy continue in an attempt to resolve the classification issue. Suggestions by the Navy that bathymetric data may be skewed or altered in a random fashion to reduce its strategic usefulness have been met by protests from the research community that claim its usefulness for research also would be reduced.

There is little doubt that the Navy's strategic concern over the value of high-resolution bathymetry to potentially hostile forces is well founded. However, critics of the Navy's position cite mitigating factors that they consider to undermine the Navy's security argument, such as the availability of multi-beam technology in foreign vessels; the U.S. policy of open access for research in the EEZ, which would allow foreign vessels to gather similar data; and the stringent criteria for classification established by the Navy that could include existing bathymetric charts that have been in the public domain for some time.

The importance of high-resolution bathymetry to efficient exploration of the EEZ is apparent. Both the Navy and the scientific community have failed to effectively communicate their concerns to each other. To ensure that the scientific community has access to precise bathymetry to facilitate the exploration of the EEZ and at the same time to protect the national security, a flexible policy must be agreed to and supported by all parties. Undoubtedly, there will be appreciable financial costs connected to such a policy, but it should be considered a cost of doing the government's business in the modern, high-technology research environment.

Before the marine mining industry will invest substantially in commercial prospecting in the EEZ, it must have assurances that the Federal Government will encourage development and grant access to the private sector to explore and develop seabed minerals. While the Outer Continental Shelf Lands Act authorizes the Secretary of the Interior to lease non-energy minerals as well as oil and gas in the Outer Continental Shelf, little guidance is provided by the legislation for structuring a hard mineral leasing program. There also is disagreement as to whether the Secretary's mineral leasing authority can be extended to areas beyond the limits of the continental shelf in the EEZ. Furthermore, the bidding requirements for hard mineral leases, which require advance payment of money before a mine site is delineated, may not be workable for EEZ hard minerals. New marine mining legislation is needed to ensure the seabed mining industry that it will have a suitable Federal leasing program in place when it is needed.

SUMMARY AND FINDINGS

With a few possible exceptions (e. g., sand and gravel and precious metals), the commercial prospects for developing marine minerals within the Exclusive Economic Zone appear to be remote for the foreseeable future. There is currently no operational domestic seabed mining industry per se, although some international mining consortia have a continuing interest in deep seabed manganese nodules and perhaps cobalt-manganese crusts in the EEZ.

One land-based mining company is currently operating a gold mining dredge in Alaskan State waters, and sand is being mined at the entrance to New York Harbor. Commercial interest in some near-shore placer deposits and Blake Plateau manganese nodules has occurred sporadically. Because of the economic uncertainties and financial risks of EEZ mining, it is doubtful that the private sector will undertake substantial exploration in the EEZ until

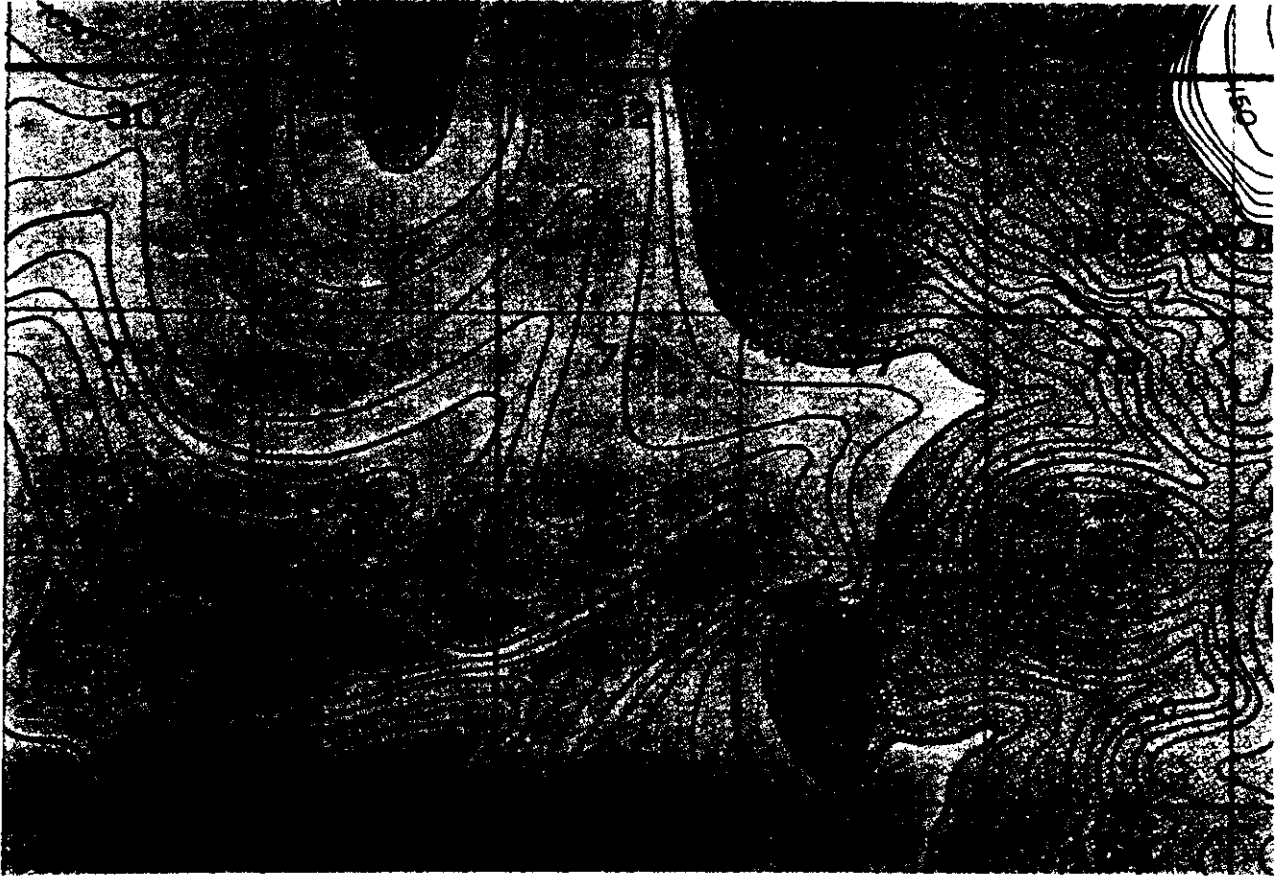

Advances in mapping technology have provided oceanographers with valuable detailed information about the depths and topography of the seafloor. However, the accuracy and precision of multi-beam and echo-sounding also makes the maps valuable for military navigation and positioning. (Old technology on this page; new technology opposite).

Source: National Geophysical Data Center, NOAA

more is known about marine minerals. Preliminary reconnaissance and exploration by the Federal agencies to determine mining opportunities, as well as assurances from Congress that the Federal Government will provide an appropriate administrative framework and economic climate to conduct business offshore, probably will be needed to interest the private sector in further prospecting and possible development.

The possible strategic importance of some EEZ minerals is additional justification for the United States to maintain momentum in exploring its offshore public domain. We know too little about the mineral resource potential of the EEZ to judge its long-term commercial viability or its strategic value in supplying critical minerals in times of emergency. A time may come, however, when it is judged that it is vital to the Nation that the Fed-

eral Government indirectly or directly support the offshore mining industry to maintain a competitive, strategic position in seabed mining relative to European countries, Japan, and other industrial nations.

The vastness of the U.S. EEZ requires that exploration proceed according to well-thought-out plans and priorities. Federal agencies will have to coordinate efforts, share equipment, and collaborate in a collegial atmosphere. Academicians, State personnel, and scientists and engineers from private industry also will be major participants in the Federal EEZ exploration program. To achieve this extraordinary level of collaboration inside and outside the Federal Government, a broad-based coordinating mechanism is likely to be needed to tie the various public, academic, and private sector EEZ activities together.

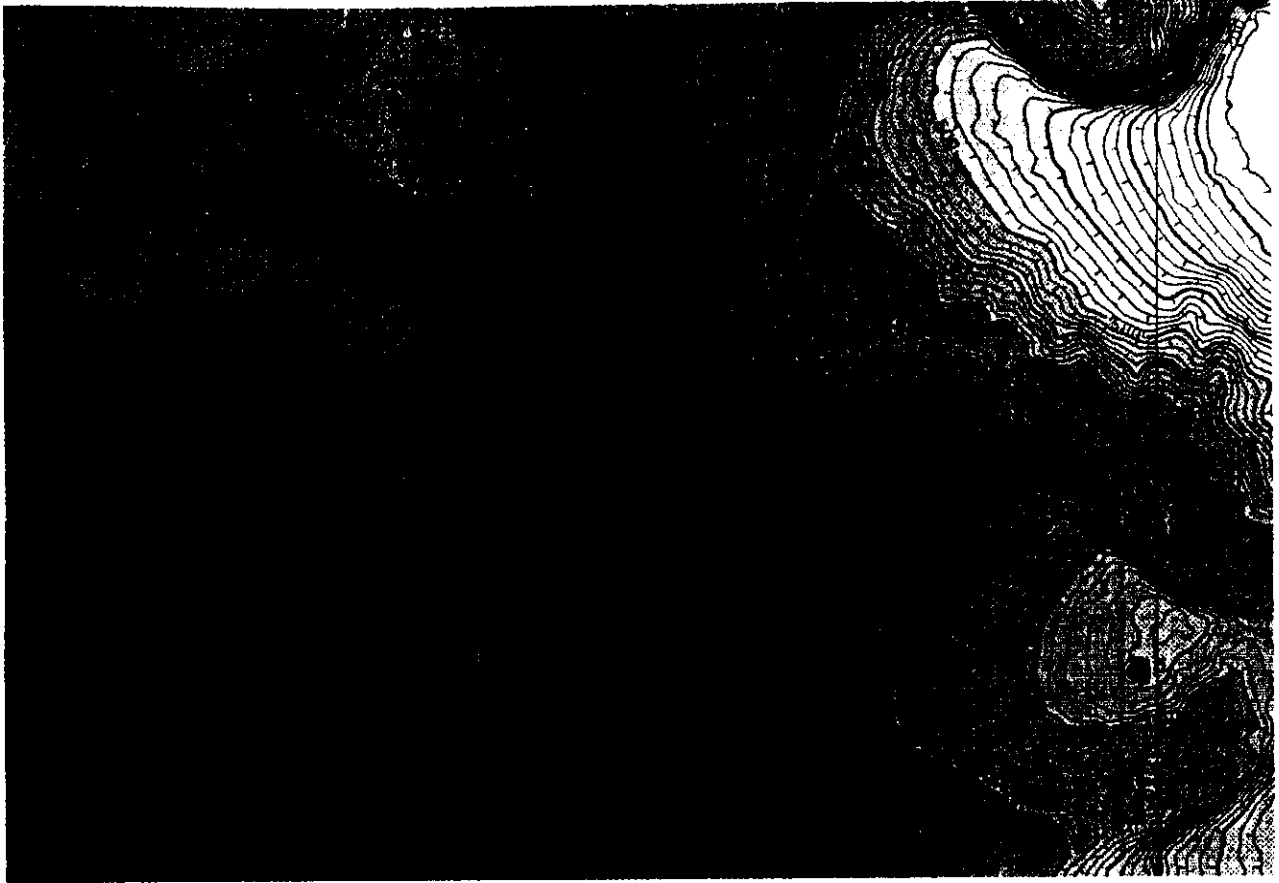

ISSUES AND OPTIONS

Although EEZ exploration costs could be large in the aggregate, there are several possible low-cost actions that Congress might take along the way to bolster the national effort by focusing the government exploration effort and improving Federal agency performance through better communication, coordination, and planning. The major needs of the fledgling U.S. ocean mining industry might be best met through appropriate legislation aimed at providing a suitable Federal administrative management framework.

Focusing *the National Exploration Effort*

Responsibility for various aspects of EEZ minerals exploration is shared by several Federal agencies: U.S. Geological Survey, National Oceanic and

Atmospheric Administration, Minerals Management Service, U.S. Bureau of Mines, U.S. Navy, U.S. Army Corps of Engineers, National Aeronautics and Space Administration, Department of Energy, Environmental Protection Agency, National Science Foundation, and several other contributing agencies. Moreover, the major academic oceanographic institutions—Scripps Institution of Oceanography, Woods Hole Oceanographic Institution, Lamont-Doherty Geological Observatory—play a key role in the pursuit of scientific knowledge about the seafloor and the ocean environment, as do a large number of marine scientists at many universities and colleges throughout the country.

State agency efforts, though modest in comparison to the Federal programs, are focused on the 3-mile territorial sea under the coastal State's con-

. . . it is important to ensure that Federal agencies coordinate their complementary and overlapping functions. . . .

trol and provide an important adjunct to the Federal exploration efforts. The offshore mining industry's stake in the outcome of the Federal EEZ exploration program also necessitates that the industry be a major contributor to national EEZ planning.

With the large number of actors involved in collecting EEZ information, it is important that their efforts be focused and coordinated through a national exploration plan—yet no such planning process currently exists. In an effort to coordinate EEZ activities in NOAA and USGS, these two agencies recently established a joint EEZ office (Joint Office for Mapping and Research) to foster communication between them and to establish an EEZ point of contact for the public. The joint EEZ office is a positive step towards coordination, but its activities apply principally to the sponsoring agencies and there is no separate funding for this office.

MMS also has made efforts to improve communications and information transfer with the coastal States regarding anticipated offshore mineral leasing in the EEZ. State-Federal working groups have been organized for cobalt crusts off Hawaii; polymetallic sulfides and placers off Washington, Oregon, and California; phosphorites off North Carolina; heavy mineral sands off Georgia; and placers in the Gulf of Mexico. Such efforts to coordinate Federal EEZ activities are good as far as they go, but they fall short of providing the comprehensive focus needed to integrate the full range of government activities with those of the States, academic institutions, and the seabed mining industry.

Faced with a similar planning and coordination problem in Arctic research, Congress enacted the Arctic Research and Policy Act (Public Law 98-373) in 1984. The Act established an Interagency Arctic Research Policy Committee composed of the 10 key agencies involved in Arctic research. A parallel organization, the Arctic Research Commission, was concurrently established to represent the

academic community, State and private interests, and residents of the Arctic and to advise the Federal Government. The Federal Interagency Arctic Research Policy Committee and the Arctic Research Commission are charged with developing 5-year Arctic research plan which includes goals and priorities. Budget requests for funding of Arctic research for each Federal agency under the plan are to be considered by the Office of Management and Budget (OMB) as a single "integrated, coherent, and multi-agency request" (Sec. 110). The Arctic Research and Policy Act does not authorize additional funding for Arctic research. Each Federal agency designates a portion of its proposed budget for "Arctic research" for the purpose of OMB review.

Congress opted for a similar solution to coordinate multi-agency research activities in acid precipitation. Title VII of the Energy Security Act of 1980 (Public Law 96-294) established an Acid Precipitation Task Force, consisting of 12 Federal agencies, 4 National Laboratories, and 4 presidential appointees from the public. The Task Force was assigned responsibility for developing and managing a 10-year research plan. Funds (\$5 million) were authorized by the Act to underwrite the cost of developing the plan and to support the Task Force. Research funds requested by the Federal agencies (comprising each agency's acid precipitation research budgets) are combined annually into a National Acid Precipitation Assessment Program budget that is submitted to OMB as a unit.

Both the Arctic Research and Policy Act and Title VII of the Energy Security Act may be considered prototypes for focusing, planning, budgeting, and coordinating Federal exploration and research activities in the EEZ. Neither Act has proved to be expensive, nor has either unduly encroached on the autonomy, jurisdiction, or missions of the individual agencies. Neither Act authorizes or earmarks special funds for its intended purposes (except to offset the cost of plans and administration), but collective budgets are presented to OMB along with plans and programs to justify the expenditure of the requested funds. Both approaches build in participation from the general public and the private sector in developing research plans.

Another approach to interagency planning and coordination is used for marine pollution. The Na-

tional Ocean Pollution Planning Act of 1978 (Public Law 95-273) designates NOAA as the lead agency for compiling a 5-year plan for Federal ocean pollution research and development (R&D), a plan that is revised every 3 years. The National Marine Pollution Program links the R&D activities of 11 Federal agencies, establishes priorities, and reviews the budgets of the agencies with regard to the goals of the program and screens them for unnecessary duplication. Public participation in Federal planning is fostered through workshops at which marine pollution R&D progress is reviewed and future trends and priorities discussed. Each agency submits its own budget request to OMB, but appropriations are authorized to cover NOAA's expenses for preparing the plan and monitoring progress. In 1986, the Act was amended to provide for an interagency board that will review individual agency budget requests in the context of the current 5-year plan.

Congressional Options

Option 1: Establish an interagency planning and coordinating committee within the executive branch and a public advisory commission similar to those created in the Arctic Research and Policy Act, with Federal agency budgets submitted separately to OMB.

Congressional Action: Enact authorizing legislation.

Option 2: Establish an interagency planning and coordinating task force composed of Federal agency representatives and public members similar to the task force established for acid precipitation R&D by the National Energy Security Act, with a budget request combining all agency budgets in a single EEZ document.

Congressional Action: Enact authorizing legislation.

Option 3: Mandate interagency planning and coordination and assign lead-agency responsibility to a single agency as Congress did in the National Ocean Pollution Research and Development and Monitoring Act of 1978.

Congressional Action: Enact authorizing legislation.

Option 4: Allow ad hoc cooperation and coordination to continue at the discretion of Federal agency administrators.

Congressional Action: No action required.

Advantages and Disadvantages

Congress has attempted in various ways to improve the planning and coordination of government functions among Federal agencies with related missions. Informal agency coordination has largely failed in the past, although the track record of interagency coordination groups has had mixed results. To be effective, interagency coordinating mechanisms must have means to coordinate both the programs and budgets of the agencies. The success of *ad hoc* agency coordination depends primarily on comity and cooperation among government managers. Therefore, personnel changes, which happen frequently at high levels of the Federal Government, can alter an otherwise amiable relationship among the agencies and destroy what may have been an effective coordination effort.

Efforts by Congress to improve agency accountability, planning, coordination, and budgeting through legislation have also met with mixed results. Some laws require elaborate plans that must be updated periodically and transmitted concurrently to Congress and the President. Other statutes require that annual reports be similarly compiled and transmitted. Such information can be useful to Congress in carrying out its oversight responsibility for agency performance and may be useful to the President in his capacity as "chief executive officer" of the Federal Government.

The extent to which congressional committees and the President effectively use these agency plans, programs, and reports required by law varies considerably. In some cases, agency plans and programs receive little or no attention from Congress; in other cases, such as the MMS 5-year leasing program required under the Outer Continental Shelf Lands Act, the planning document often becomes the focus of public debate.

Although Federal agencies often have closely related functions, their budgets are generally for-

mulated with little or no mutual consultation. Furthermore, budget examiners at OMB who are responsible for the review of individual agencies seldom collaborate with other OMB examiners who are responsible for other agencies with similar programs (e. g., NOAA's budget is reviewed by a different OMB budget examiner than is DOI). A similar situation exists within Congress among the appropriations subcommittees that are responsible for individual agency appropriations. To remedy this problem, Congress has in several cases mandated that "cross-cutting" budget analyses be prepared for related multiple-agency activities so that the entire range of funds directed toward a specific effort can be easily seen. Cross-cutting budget analyses are required in the Arctic Research and Policy Act, Title VII of the Energy Security Act, and the National Ocean Pollution Research and Development and Monitoring Act of 1978.

OMB exercises nearly omnipotent control over the funding levels recommended in the President's budget that is submitted to Congress each year. Program budgets that are presented to Congress are arrived at through a byzantine negotiation process that involves OMB, Cabinet departments, agencies within the departments, programs within agencies, and finally, if appealed, the President. The budget process is internal, and neither the public nor Congress is privy to the negotiations.

Congress has attempted to open the executive branch budget process to more public scrutiny by directing the agencies by statute to submit recommended program budgets directly to Congress as part of the interagency planning and coordination process without prior review by OMB; the National Ocean Pollution Research and Development and Monitoring Act uses this mechanism. Although the approach appears reasonable in theory, it seldom—if ever—works in reality. OMB continues to maintain its authority over all budget recommendations transmitted to Congress from within the executive branch.

Unified budget submissions to OMB accompanied by cross-cutting budget analyses and program plans that justify the funding levels, such as provided in both the Arctic Research and Policy Act and Title VII of the Energy Security Act, seem to work reasonably well for developing rational inter-agency budgets within the normal budget process.

As currently implemented under the Energy Security Act, unified budget submissions from several agencies in a single document covering acid precipitation have the advantage of earmarking funds specifically for research in each agency as if it were a line item in the budget; on the other hand, the Arctic Research and Policy Act merely requires that Arctic R&D be "designated" in the normal agency budget submissions to OMB. The budget procedures under the Energy Security Act focus more directly on the multi-agency budget related to acid precipitation rather than on the single budget of each agency. The National Ocean Pollution Research and Development and Monitoring Act provides little advantage over the normal agency budgeting process.

Providing for Future Seabed Mining

The Outer Continental Shelf Lands Act (OCSLA) authorizes the Secretary of the Interior to lease minerals in the Outer Continental Shelf. Although the main thrust of OCSLA is directed toward oil and gas, provisions are also included for leasing sulfur (Sec. 8[i] and [j]), and other minerals (Sec. 8[k]). Sulfur has been mined in the Gulf of Mexico since 1960 using borehole solution mining techniques. Because of the similarities between sulfur mining and oil and gas extraction, DOI applies to sulfur the same general regulations that govern petroleum operations.¹³ When OCSLA was enacted in 1953, little was known about hard minerals in the continental shelf. Scientists were aware of their existence, but technology was then not generally available for either exploring or mining the seabed for hard mineral deposits.

DOI claims jurisdiction under OCSLA to all offshore areas seaward of the territorial sea over which the United States asserts jurisdiction and control. Since the United States is not a party to the Law of the Sea Convention, the only applicable treaty recognized by DOI as affecting offshore jurisdiction is the 1958 Convention on the Continental Shelf.¹⁴ The 1958 Convention authorizes coastal

¹²Public Law 83-212; 67 Stat. 462, Aug. 7, 1953; 43 U. S. C. 1331-1356; as amended by Public Law 93-627; 88 Stat. 2126, Jan. 3, 1975; and 95-372; 92 Stat. 629, Sept. 18, 1978.

¹³³⁰Code of Federal Regulations, ch. II, part 250.

¹⁴Convention on the Continental Shelf, in force June 10, 1964, 15 UST 471, TIAS No. 5578, 499 U. N. T. S. 311.

Before the marine mining industry will invest substantially in commercial prospecting in the EEZ, it must have assurances that the Federal Government will encourage development and grant access to the private sector to explore and develop seabed minerals.

State control over the seabed to a depth of 200 meters or beyond “where the depth of the superjacent water admits of the exploitation of the natural resources. DOI concludes that the concept of ‘exploitability’ in the 1958 Convention further supports the department’s opinion that the legal continental shelf includes the breadth of the 200-mile Exclusive Economic Zone, regardless of the physical attributes of the submarine area.

DOI’s Minerals Management Service most recently attempted to lease hard minerals in March 1983, when plans were announced to prepare an environmental impact statement for a proposed lease sale of polymetallic sulfide minerals associated with the Gorda Ridge geological complex.¹⁵ Authority for the proposed lease sale was based on Section 8(k) of OCSLA.¹⁶ The site of the mineral deposits of the Gorda Ridge is a tectonic spreading center and, therefore, is not part of the geological continental shelf. DOI based its authority to lease the area on the definition of the “legal” continental shelf implied in Section 2(a) of OCSLA.¹⁷ The Gorda Ridge lease sale is yet to be held, but, in March 1987, MMS published proposed rules for prelease prospecting for non-energy marine minerals.¹⁸ The prelease prospecting rules are the first of a three-tier regulatory program proposed by MMS; future rules would cover leasing and post-leasing operations.

¹⁵“Scoping Notice to Prepare an Environmental Impact Statement, *Federal Register*, vol. 48, Mar. 28, 1983, p. 12840.

¹⁶Sec. 8(k): “The Secretary is authorized to grant to the qualified persons offering the highest bonuses on a basis of competitive bidding leases of any mineral other than oil, gas, and sulfur in any area of the Outer Continental Shelf not then under lease for such mineral upon such royalty, rental, and other terms and conditions as the Secretary may prescribe at the time of offering the area for lease.

¹⁷Frank K. Richardson, ‘Opinion of the Solicitor,’ U.S. Department of the Interior, May 30, 1985.

¹⁸*Federal Register*, vol. 52, Mar. 26, 1987, p. 9753.

Environmental groups and industry representatives have questioned DOI’s leasing authority under OCSLA, claiming that DOI is misinterpreting the 1958 Convention by delineating the breadth of the continental shelf to include the 200-mile EEZ by using the “exploitability” definition in OCSLA. These groups have asserted that no U.S. agency has statutory authority to grant leases or licenses to recover hard minerals from the seafloor beyond the Outer Continental Shelf, except for NOAA which has authority to license commercial manganese nodule mining only. There is no disagreement that DOI has authority to lease hard minerals in the Outer Continental Shelf. The controversy extends only to how far that authority extends seaward beyond the geological continental shelf.

Notwithstanding the legal question of whether DOI has legislative authority to lease in the 200-mile EEZ beyond the geographical limits of the continental shelf, questions remain about the adequacy of the Outer Continental Shelf Lands Act for administering an EEZ hard minerals leasing program.

Several shortcomings limit OCSLA’s suitability for managing hard minerals in either the Outer Continental Shelf or the EEZ:

- DOI is given little congressional guidance for planning, environmental guidelines, inter-governmental coordination, and other administrative details needed for structuring a hard mineral leasing regime under Section 8(k) of OCSLA.
- Section 8(k) of the Act is discretionary with the Secretary of the Interior; thus, there are no assurances to the industry that a stable, predictable leasing program will be continued by subsequent administrations.
- Bonus bid competitive leasing requirements (money paid to the government before exploration or development begins) set forth in Section 7(k) of OCSLA are not well suited for stimulating exploration and development of seabed hard minerals by the private sector.
- The Outer Continental Shelf Lands Act does not apply to the territories; therefore, the Minerals Management Service may not have authority to lease in a large area of the EEZ adjacent to the U.S. Territories.¹⁹

¹⁹The narrow definition of the term “State as used in the Sub-
(continued on next page)

An ad hoc working group consisting of representatives of the marine minerals industry, environmental groups, coastal States, and academicians was formed in 1986 to develop a conceptual framework for managing marine minerals in the EEZ. After several meetings, the members reached a consensus that the Outer Continental Shelf Lands Act was unsuitable for administering a seabed hard minerals exploration and development program, and that new “stand-alone” legislation is needed to replace the oil- and gas-oriented OCSLA.²⁰ The working group recommended that the authorizing legislation should:

1. use the Deep Seabed Hard Minerals Resources Act (Public Law 96-283) mining provisions and its regime for public participation and multiple-use conflict resolution as a model for new EEZ seabed mining legislation;
2. provide for a comprehensive and systematic research plan including bathymetric charting, mineral reconnaissance, and environmental baseline studies;
3. require wide public dissemination of data but protect confidential information;
4. provide incentives for private industry to collect and contribute to the resource information base;
5. apply legislation to all areas within the U.S. EEZ and the territories consistent with U.S. authority and obligations; and
6. provide for effective Federal/State/local consultation.

Legislation was introduced in both the 99th and 100th Congresses to establish a regime for exploring and developing hard minerals in the EEZ.²¹ H.R. 1260, The National Seabed Hard Minerals

merged Lands Act and incorporated into the Outer Continental Shelf Land Act (Sec. 6(c)) limits the applicability of OCSLA to the waters off “any State of the Union. This definition contrasts with other laws that specify Congress’ intent to extend their effect to the territories as well.

²⁰Clifton Curtis, President, Oceanic Society, Memorandum, Apr. 1, 1986, to Ann Dore McLaughlin, Under Secretary of the Interior.

²¹H. R. 1260, National Seabed Hard Minerals Act, 100th Cong., 1st sess., Feb. 25, 1987; H.R. 5464, 99th Cong., Sponsor: Lowry et al. Another bill would impose a temporary moratorium on seabed mining in the Gorda Ridge, H. R. 787, Ocean Mineral Resources Development Act, 100th Cong., 1st sess., Jan. 28, 1987, Sponsor: Bosco.

Act of 1987, includes many of the suggestions by the ad hoc working group.

According to DOI, MMS’s proposed rules for prelease prospecting of marine minerals is a first step toward providing access for private industry to obtain geologic and geophysical information about the EEZ (box 1-C). With the likelihood that development of EEZ minerals will not take place any time soon, the promulgation of acceptable prelease prospecting rules under OCSLA maybe sufficient to allow preliminary prospecting by the industry while Congress formulates and enacts EEZ seabed mining legislation that overcomes the deficiencies of OCSLA.

Congressional Options

Option 1: Enact “stand-alone” legislation for exploring and developing minerals in the U.S. EEZ patterned after the Deep Seabed Hard Minerals Resources Act.

Congressional Action: Enact new legislation.

Option 2: Amend the Outer Continental Shelf Lands Act by adding a new title to apply exclusively to marine hard minerals in the EEZ.

Congressional Action: Amend the Outer Continental Shelf Lands Act.

Option 3: Amend the Outer Continental Shelf Lands Act to extend its application to U.S. territories and possessions. Section 8(k) could either be amended to provide guidelines for marine hard mineral leasing or be allowed to remain in its present form. The Outer Continental Shelf also might be redefined so as to be identical to the Exclusive Economic Zone.

Congressional Action: Amend the Outer Continental Shelf Lands Act.

Option 4: Permit the Minerals Management Service to continue to develop a regulatory system based on its authority under the Outer Continental Shelf Lands Act, but amend Section 8(k) to provide more specific guidance for administration, planning, and coordination.

U.S. innovation and engineering know-how applied to developing seabed mining technology could place the United States in a pivotal competitive position to exploit a world market. . . for seabed mining equipment.

Congress also has the option of merely broadening the geographical coverage of the Outer Continental Shelf Lands Act to include the U.S. territories and possessions. Such action, if it applied to the Act in general, would also open these areas to potential oil and gas leasing in the future, although the EEZs of most of the territories and possessions are not known to have oil and gas potential. If Congress chose to redefine the Outer Continental Shelf and make it identical to the EEZ, the status of the oil and gas leasing program might be clarified in some areas of legal uncertainty beyond the continental shelf but within the 200-nautical mile zone.

Improving the Use of the Nation's EEZ Data and Information

Oceanographic data collected in the course of exploring the EEZ are a national asset. Because of the immense size of the U.S. EEZ, exploration activities are likely to continue for decades. Information and data may take many forms, may differ in quality, may come from many geographical areas, and may be collected by many agencies and entities. It is important that such data be evaluated, archived, processed, and made available to a wide range of potential users in the future.

As the pace of EEZ exploration increases, the existing Federal oceanographic data systems—which are currently taxed near their capacity based on available funding and resources—probably will be unable to adequately manage the load. Even today, in some cases, data must be discarded for lack of storage and handling facilities, and user services are limited. In other cases, Federal agencies sometimes do not submit data acquired at public expense to the National Oceanographic Data Center or the National Geophysical Data Center in a timely and systematic manner.

Limitations on the national data centers are primarily institutional, budgetary, and service-connected. Funding for data archiving and dissemination generally has been considered a lower priority by the Federal agencies than data collection. The historical usefulness of oceanographic, environmental, and resource information is often overlooked by Federal managers with mission-oriented responsibilities.

Consistent policies for transmittal of EEZ-related information to the national data centers are lacking in many Federal agencies. However, inventories of data collected by the academic community under the auspices of the National Science Foundation's Division of Ocean Sciences are required to be transmitted to the national data centers in a timely manner as a condition of its research grants. The Ocean Science Division's ocean data policy is an excellent example that other Federal agencies might emulate.

But even with more effective policies to ensure transmittal of EEZ information to the national data centers, little improvement in efficiency can be expected unless resources—both equipment and personnel—are upgraded and expanded commensurate with the expected increase in the workload. The mere “storage” of data does not fulfill the national need; such information must be retrievable and made available to a wide range of potential users, including Federal agencies, State agencies, academia, industry, and the general public.

Improved data services will require additional funds to raise the level of capability and performance of the existing national data centers. Eventually, regional data centers may be required to adequately service the public needs; but for the time being the major Federal effort aimed at improving data services probably should be directed at upgrading the performance of the existing centers.

Congressional Options

Option 1: Direct each Federal agency to establish an EEZ data policy that will ensure the timely and systematic transmittal of oceanographic data to either the National Oceanographic Data Center or the National Geophysical Data Center, whichever is appropriate.

Congressional Action:

- a. Amend authorizing legislation for each appropriate program and/or Federal agency.
- b. Direct action through the annual appropriations process.
- c. Enact general legislation that would apply to all Federal agencies collecting EEZ data and information.

Option 2: Provide additional funds and directives to the National Oceanographic Data Center and the National Geophysical Data Center to upgrade EEZ data services according to a plan, to be developed by the National Oceanic and Atmospheric Administration, for meeting the future needs of archiving and disseminating EEZ data and information.

Congressional Action: Issue directive through the annual appropriations process.

Option 3: Continue at the current level of funding and continue to permit the Federal agencies to transmit EEZ-related information to the National Oceanographic Data Center and the National Geophysical Data Center at each agency's discretion.

Congressional Action: No action required.

Advantages and Disadvantages

Incentives for the agencies and the academic community to place more emphasis on data services could take several forms. Since improvements in data services are tied to adequate funding, the most expedient approach for Congress would be to direct appropriate agency actions through the annual appropriations process. This option, however, would only be effective for one budget cycle and would have to be repeated annually if an effective long-term data services program were to continue.

Amendments to individual agency authorizing legislation, or alternative "umbrella" legislation applicable to all agencies collecting EEZ data and information, would establish continuing programs to improve data services. Long-term plans for meeting the expanding EEZ data needs of the future should provide guidelines for improving overall government data services.

Providing for the Use of Classified Data

National security may require that public dissemination and use of certain EEZ-related data continue to be restricted. This restriction may result in some hardship and perhaps additional expense to the scientific community as well as the marine minerals industry, but it need not totally lock up that information. There are responsible ways in which classified data can be made available to those needing to use such data for further EEZ exploration.

Federal personnel, contractors, and academicians in many technical and engineering fields have access to and routinely use classified information on a daily basis. While maintaining security installations is sometimes unwieldy and expensive, it may be possible to achieve a compromise between the national need for security and the national need for timely and efficient exploration of the EEZ by establishing secure data centers to manage classified EEZ data.

Other aspects of EEZ data classification may prove to be more troublesome. The ocean science community may be restricted from publishing some EEZ data or information that would, if unclassified, be freely available in the scientific literature. There are also inconsistencies in U.S. policy regarding scientific access of foreign investigators to the U.S. EEZ and the Navy's access to foreign EEZs to gather hydrographic information that seem at odds with current EEZ data classification policies. Diplomatic questions may arise from these inconsistencies that could result in access restriction for U.S. scientists working in the EEZs of other countries.

Congressional Options

Option 1: Establish regional classified data centers at major oceanographic institutions or at colleges and universities, with access assured for certified scientists and with guidelines established for the use and publication of data sets and bathymetric information.

Congressional Action: Direct the Department of Defense in collaboration with the National Oceanic and Atmospheric Adminis-

tration to establish regional classified centers under contract with academic institutions for the operation and administration of the centers, or consider Federal operation of such centers.

Option 2: Review the current EEZ data classification policies and assess their possible effects on academic research and their possible international impacts on access to other countries' EEZs by U.S. scientists.

Congressional Action: Hold oversight hearing on Navy's classification policies and procedures.

Option 3: Continue to allow the National Oceanic and Atmospheric Administration and the Navy to seek a solution to the EEZ data classification problem.

Congressional Action: No legislative action required.

Advantages and Disadvantages

The cost of establishing and operating regional classified data centers either at academic institutions or at Federal centers is likely to be significant. There also may be policies at some of the academic institutions that prohibit the location of classified data centers at their facilities.

Congress may choose to learn more about the details of the need for classification of EEZ data and the impact that classification restrictions might have on scientific activities and commercial exploration before it takes further action. Classified hearings may be needed to fully evaluate the security implications of EEZ data.

Without either legislative or oversight activities by Congress, the uncertainties regarding the future availability of classified data may continue for some time until mutual agreement is reached between the Navy and the National Oceanic and Atmospheric Administration.

Assisting the States in Preparing for Future Seabed Mining

The first major U.S. efforts to commercially exploit marine minerals are likely to occur in State waters. Most coastal States do not currently have statutes suitable for administering a marine minerals exploration and development program. Many States do not separate onshore from offshore development, providing only a single administrative process for all mineral resources. Four of the States—California, Oregon, Texas, and Washington—separate the leasing of oil and gas from other minerals, but most do not.

Oregon has completed surveys of its coastal waters, and Florida, Louisiana, Maine, Maryland, New Hampshire, North Carolina, and Virginia are among the States where offshore surveys are continuing. These survey programs are often cooperative efforts between the States, the U.S. Geological Survey, and the Minerals Management Service. State-Federal task forces formed through the initiatives of the Department of the Interior are assisting the coastal States in coordinating their efforts with marine minerals exploration currently taking place in the EEZ. State-Federal task forces have been formed in Hawaii (cobalt-manganese crusts), Oregon and California (polymetallic sulfides in the Gorda Ridge), North Carolina (phosphorites), Georgia (heavy mineral sands), and the Gulf States (sand, gravel, and heavy minerals off Alabama, Louisiana, Mississippi, and Texas),

The Federal Government could provide valuable technical assistance to the States in preparing for possible exploration and development of marine minerals in nearshore State waters. The Federal-State task forces are currently coordinating the States' and DOI's activities in the EEZ, but further assistance may be needed in formulating State legislation for leasing, permitting, or licensing marine minerals activities in the States' territorial seas.

Such legislative initiatives must originate with the individual States, but the Federal Government could provide assistance through existing programs

such as those authorized by the Coastal Zone Management Act. Private organizations, such as the Coastal States Organization or the National Governors Association, could also serve as a catalyst and guide to States for developing legislative concepts or model seabed mining legislation.

Congressional Options

Option 1: Direct the National Oceanic and Atmospheric Administration's Office of Ocean and Coastal Resource Management to provide technical assistance and financial support to coastal States' coastal zone management programs to formulate State marine minerals management legislation through the Coastal Zone Management Act, Section 309 grants program.

Congressional Action: Issue directive through the annual appropriations process,

Option 2: Direct the Minerals Management Service to provide technical assistance to the States to aid in formulating marine minerals legislation that could provide an interface between marine minerals activities in the EEZ adjacent to the States' territorial seas.

Congressional Action: Issue directive through the annual appropriations process.

Option 3: Provide technical assistance and funds to the coastal States to aid in formulating marine minerals legislation through seabed mining legislation enacted as a "stand-alone" statute, amendments to Section 8(k) of the Outer Continental Shelf Lands Act, or through a new title in the Outer Continental Shelf Lands Act.

Congressional Action: Enact stand-alone legislation or amend the Outer Continental Shelf Lands Act.

Option 4: Rely on the individual initiative of the coastal States to undertake a legislative effort to formulate marine minerals legislation.

Congressional Action: No action required.

Advantages and Disadvantages

Directives to agencies through the annual appropriations process are often followed to the minimal extent possible and only apply to the expenditure of funds during the specific fiscal year. Authorizing legislation is probably needed to ensure a continuing, long-term effort.

Chapter 2
Resource Assessments and Expectations

CONTENTS

	<i>Page</i>
World Outlook for Seabed Minerals	39
General Geologic Framework	41
Atlantic Region	43
Sand and Gravel	45
Placer Deposits	48
Phosphorite Deposits	52
Manganese Nodules and Pavements	53
Puerto Rico and the U.S. Virgin Islands	54
Sand and Gravel	54
Placer Deposits	55
Gulf of Mexico Region	55
Sand and Gravel	55
Placer Deposits	56
Phosphorite Deposits	56
Pacific Region	56
Sand and Gravel	57
Precious Metals	58
Black Sand—Chromite Deposits	58
Other Heavy Minerals	60
Phosphorite Deposits	61
Polymetallic Sulfide Deposits	61
Alaska Region	65
Sand and Gravel	67
Precious Metals	67
Other Heavy Minerals	69
Hawaii Region and U.S. Trust Territories	69
Cobalt-Ferromanganese Crusts	70
Manganese Nodules	75

Box

<i>Box</i>	<i>Page</i>
2-A. Mineral Resources and Reserves	40

Figures

<i>Figure No.</i>	<i>Page</i>
2-1. Idealized Physiography of a Continental Margin and Some Common Margin Types	42
2-2. Sedimentary Basins in the EEZ	44
2-3. Sand and Gravel Deposits Along the Atlantic, Gulf, and Pacific Coasts	46
2-4. Plan and Section Views of Shoals Off Ocean City, Maryland	47
2-5. Atlantic EEZ Heavy Minerals	51
2-6. Potential Hard Mineral Resources of the Atlantic, Gulf, and Pacific EEZs	54
2-7. Formation of Marine Polymetallic Sulfide Deposits	62

<i>Figure No.</i>	<i>Page</i>
2-8. Locations of Mineral Deposits Relative to Physiographic Features	66
2-9. Potential Hard Mineral Resources of the Alaskan EEZ	68
2-10. Potential Hard Mineral Resources of the Hawaiian EEZ	70
2-11. Cobalt-Rich Ferromanganese Crusts on the Flanks of Seamounts and Volcanic Islands	71
2-12. EEZs of U.S. Insular and Trust Territories in the Pacific	73
2-13. Potential Hard Mineral Resources of U.S. Insular Territories South of Hawaii	75
2-14. Potential Hard Mineral Resources of U.S. Insular Territories West of Hawaii	76

Tables

<i>Table No.</i>	<i>Page</i>
2-1. Association of Potential Mineral Resources With Types of Plate Boundaries	43
2-2. Areas Surveyed and Estimated Offshore Sand Resources of the United States	48
2-3. Criteria Used in the Assessment of Placer Minerals	50
2-4. Estimates of Sand and Gravel Resources Within the U.S. Exclusive Economic Zone	56
2-5. Estimates of Typical Grades of Contained Metals for Seafloor Massive Sulfide Deposits, Compared With Typical Ore From Ophiolite Massive Sulfide Deposits and Deep-Sea Manganese Nodules	63
2-6. Average Chemical Composition for Various Elements of Crusts From <8,200 Feet Water Depth From the EEZ of the United States and Other Pacific Nations	72
2-7. Resource Potential of Cobalt, Nickel, Manganese, and Platinum in Crusts of U.S. Trust and Affiliated Territories	74
2-8. Estimated Resource Potential of Crusts Within the EEZ of Hawaii and U.S. Trust and Affiliated Territories	75

Resource Assessments and Expectations

WORLD OUTLOOK FOR SEABED MINERALS

Ever since the recovery of rock-like nodules from the deep ocean by the research vessel *H.M.S. Challenger* during its epic voyage in 1873, there has been persistent curiosity about seabed minerals. It was not until after World War II that the black, potato-sized nodules like those found by the *Challenger* became more than a scientific oddity. As metals prices climbed in response to increased demand during the post-war economic boom, commercial attention turned to the cobalt-, manganese-, nickel-, and copper-rich nodules that litter the seafloor of the Pacific Ocean and elsewhere. Also, as the Nation's interest in science peaked in the 1960s, oceanographers, profiting from technological achievements in ocean sensors and shipboard equipment developed for the military, expanded ocean research and exploration. The secrets of the seabed began to be unlocked.

Even before the *Challenger* discovery of manganese nodules, beach sands at the surf's edge were mined for gold and precious metals at some locations in the world (box 2-A). There are reports that lead and zinc were mined from nearshore subsea areas in ancient Greece at Laurium and that tin and copper were mined in Cornwall.¹ Coal and amber were mined in or under the sea in Europe as early as 1860. Since then, sand, gravel, shells, lime, precious coral, and marine placer minerals (e.g. titanium sands, tin sands, zirconium, monazite, staurolite, gold, platinum, gemstones, and magnetite) have been recovered commercially. Barite has been recovered by subsea quarrying. Ironically, deep-sea manganese nodules, the seabed resource that has drawn the most present-day commercial interest and considerable private research and development investment, have not yet been recovered commercially. Rich metalliferous muds in the Red Sea have been mined experimentally and are considered to be ripe for commercial development should favorable economic conditions develop.

¹M.J. Cruickshank and W. Siapno, "Marine Minerals—An Update and Introduction," *Marine Technology Society Journal*, vol. 19, 1985, pp. 3-5.

Recent discoveries of massive polymetallic sulfides formed at seafloor spreading zones where superheated, mineral-rich saltwater escapes from the Earth's crust have attracted scientific interest and some speculation about their future commercial potential. These deposits contain copper, zinc, iron, lead, and trace amounts of numerous minerals. Similar deposits of ancient origin occur in Cyprus, Turkey, and Canada, suggesting that more knowledge about seabed mineralization processes could contribute to a better understanding of massive sulfide deposits onshore. Cobalt-rich ferromanganese crusts, found on the slopes of seamounts, have also begun to receive attention.

Beach placers and similar onshore deposits are important sources of several mineral commodities elsewhere in the world. Marine placer deposits of similar composition often lay immediately offshore. Among the most valuable marine placers, based on the value of material recovered thus far, are the cassiterite (source of tin) deposits off Burma, Thailand, Malaysia, and Indonesia. The so-called "light heavy minerals"—titanium minerals, monazite, and zircon—are found extensively along the coasts of Brazil, Mauritania, Senegal, Sierra Leone, Kenya, Mozambique, Madagascar, India, Sri Lanka, Bangladesh, China, and the southwestern and eastern coasts of Australia.

Although Australia has extensively mined "black" titaniferous beach sands along its coasts, offshore mining of these sands has not proven economical.² Titaniferous magnetite, an iron-rich titanium mineral, has been mined off the southern coast of Japan's Kyushu Island.³ Similar magnetite deposits exist off New Zealand and the Gulf of St. Lawrence. Chromite placers are extensive on beaches and in the near offshore of Indonesia, the Philippines, and New Caledonia. Chromite-

²J. Morley, *Black Sands: A History of the Mineral Sand Mining Industry in Eastern Australia* (St. Lucia: University of Queensland Press, 1981), p. 278.

³J. Mere, *The Mineral Resources of the Sea* (New York, NY: Elsevier Publishing Co., 1965), p. 16.

Fig. 3-4.—Mineral Reserves and Reserves

A general classification for describing the status of mineral occurrences was developed by the U.S. Geological Survey and the U.S. Bureau of Mines in 1976. The so-called "McKelvey Box," named after the then-director of the USGS, Vincent McKelvey, further simplified the understanding of the economic relationships of the mineral-resources classification system.

Cumulative production	RESERVES		UNDEVELOPED RESOURCES	
	Proven	Probable	Economic range	
			Hypothetical	Speculative
Reserve base	ECONOMIC	Proven	Probable	
	MARGINAL ECONOMIC			
	NOT ECONOMIC			

The reserve base is the sum of the present or anticipated future value of all minerals in place according to the economic definitions on which the resources classification is based.

- Proven reserves are those mineral resources that are economically extractable at the present time.
- Probable reserves are those mineral resources that are economically extractable at the present time or in the future, based on current technology and prices.
- Hypothetical reserves are those mineral resources that are economically extractable at the present time or in the future, based on current technology and prices, but which have not been measured directly.
- Speculative reserves are those mineral resources that are economically extractable at the present time or in the future, based on current technology and prices, but which have not been measured directly and are based on unproven geological information.

bearing beach sands were mined along the southern coast of Oregon during World War 11 with government support.

Gold has been mined from many beach placers along the west coast of the United States and elsewhere in the world. Marine placers of potentially

minable gold are located in several nearshore Alaskan areas in the Bering Sea, Gulf of Alaska, and adjacent to southeastern Alaska. A commercial gold dredge mining operation was begun by Inspiration Resources near Nome in 1986, but a number of nearshore gold operations in the Nome area have been attempted and abandoned in the

past. Diamonds have been recovered from near-shore areas in Namibia, Republic of South Africa, and Brazil.

The recovery of sand and gravel from offshore far exceeds the extent of mining of other marine minerals. ⁴In the United States, offshore sand and

⁴J. M. Broadus, "Seabed Materials," *Science*, vol. 235, Feb. 20, 1987, pp. 853-860. Also see M. Baram, D. Rice, and W. Lee, *Marine Mining of the Continental Shelf* (Cambridge, MA: Ballinger, 1978), p. 301

gravel recovery is primarily limited to State waters, mostly in New Jersey, New York, Florida, Mississippi, and California. Japan and the European countries have depended more on marine sand and gravel than has the United States because of limited land resources. Special uses can be made of marine sand and gravel deposits in the Alaskan and Canadian Beaufort Sea—the offshore oil and gas industry uses such material for gravel islands and gravel pads for drilling.

GENERAL GEOLOGIC FRAMEWORK

The potential for the formation of economic mineral deposits within the Exclusive Economic Zone (EEZ) of the United States is determined by the geologic history, geomorphology, and environment of its continental margins and insular areas. Continental margins are a relatively small portion of the Earth's total surface area, yet they are of great geological importance and of tremendous linear extent. In broad relief, the Earth's surface consists of two great topographic surfaces: one essentially at sea level—the continental masses of the world, including the submerged shelf areas—and the other at nearly 16,000 feet below sea level—representing the deep ocean basins. The boundaries between these two surfaces are the continental margins. Continental margins can be divided into separate provinces: the continental shelf, continental slope, and continental rise (see figure 2-1).

Continental margins represent active zones where geologic conditions change. These changes are driven by tectonic activity within the Earth's crust and by chemical and physical activity on the surface of the Earth. Tectonic processes such as volcanism and faulting dynamically alter the seafloor, geochemical processes occur as seawater interacts with the rocks and sediments on the seafloor, and sedimentary processes control the material deposited on or eroded from the seafloor. All of these processes contribute to the formation of offshore mineral deposits.

Advanced marine research technologies developed since World War II and the refinement and acceptance of the plate-tectonics theory have created a greater understanding of the dynamics of continental margins and mineral formation. Ac-

cording to the plate-tectonics model, the Earth's outer shell is made up of gigantic plates of continental lithosphere (crust and upper mantle) and/or oceanic lithosphere. These plates are in slow but constant motion relative to each other. Plates collide, override, slide past each other along transform faults, or pull apart along rift zones where new material from the Earth's mantle upwells and is added to the crust above.

Seafloor spreading centers are divergent plate boundaries where new oceanic crust is forming. As plates move apart, the leading edge moves against another plate forming either a convergent plate boundary or slipping along it in a transform plate boundary. Depending on whether the leading edge is oceanic or continental lithosphere, this process may result in the building of a mountain range (e.g., the Cascade Mountains) or an oceanic island arc (e.g., the Aleutian Islands) or, if the plates are slipping past one another, a transform fault zone (e.g., the San Andreas fault zone).

Four types of continental margins border the United States: active collision, trailing edge, extensional transform, and continental sea. Where collisions occur between oceanic plates and plates containing continental land masses, the thinner oceanic plate will be overridden by the thicker, less dense continental plate. The zone along which one plate overrides another is called a subduction zone and frequently is manifested by an oceanic trench.

Coastal volcanic mountain ranges, volcanic island arcs, and frequent earthquake activity are related to subduction zones. This type of active continental margin borders most of the Pacific Ocean and the U.S. EEZ adjacent to the Aleutian chain

Figure 2-1.—Idealized Physiography of a Continental Margin and Some Common Margin Types

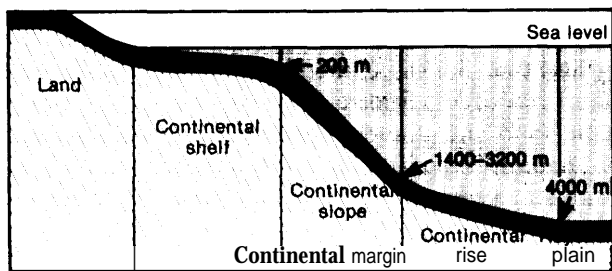

Atlantic: (trailing edge)

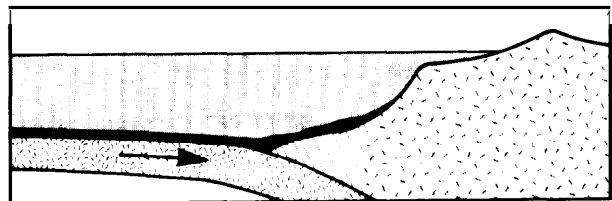

North Pacific Margin: (collision)

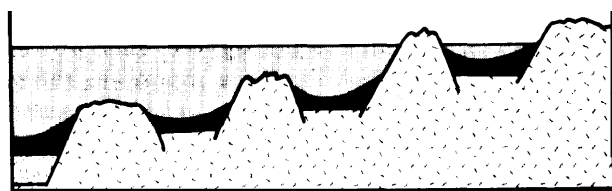

Southern California Borderland: (extentional)

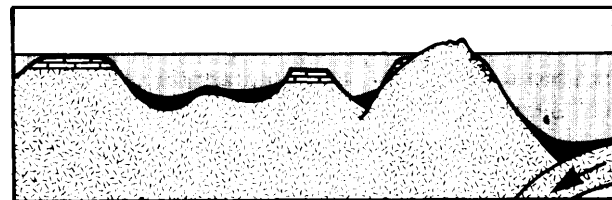

South Pacific: (volcanic arcs, trenches, and carbonate reefs)

SOURCES: Office of Technology Assessment, 1987; R.W. Rowland, M.R. Goud, and B.A. McGregor, "The U.S. Exclusive Economic Zone—A Summary of its Geology, Exploration, and Resource Potential," U.S. Geological Survey Circular 912, 1983.

and the west coast (figure 2-1). These regions have relatively narrow continental shelves and their on-shore geology is dominated by igneous intrusive and volcanic rocks. These rocks supply the thin veneer of sediment overlying the continental crust of the shelf. Further offshore, the Pacific coast EEZ extends beyond the shelf, slope, and rise to the depths underlain by oceanic crust. In the Pacific northwest, these depths encompass a region of seafloor spreading where new oceanic crust is forming. This region includes the Gorda Ridge and possibly part of the Juan de Fuca Ridge, which are located within the U.S. EEZ off California, Oregon, and Washington.

The trailing edge of a continent has a passive margin because it lacks significant volcanic and seismic activity. Passive margins are located within crustal plates at the transition between oceanic and continental crust. These margins formed at divergent plate boundaries in the past. Over millions of years, subsidence in these margin areas has allowed thick deposits of sediment to accumulate. The Atlantic coast of the United States is an example of a trailing edge passive margin. This type of coast is typified by broad continental shelves that extend into deep water without a bordering trench. Coastal plains are wide and low-lying with major drainage systems. The greatest potential for the formation of recoverable ore deposits on passive margins results from sedimentary processes rather than recent magmatic or hydrothermal activity.

The Gulf of Mexico represents another type of coast that develops along the shores of a continental sea. These passive margins also typically have a wide continental shelf and thick sedimentary deposits. Deltas commonly develop off major rivers because the sea is relatively shallow, is smaller than the major oceans, and has lower wave energy than the open oceans.

Plate edges are not the only regions of volcanic activity. Mid-plate volcanoes form in regions overlying "hot spots" or areas of high thermal activity. As plates move relative to mantle "hot spots," chains of volcanic islands and seamounts are formed

Table 2-1.—Association of Potential Mineral Resources With Types of Plate Boundaries

Type of plate boundary/Potential mineral resources
<i>Divergent:</i>
•Oceanic ridges
—Metalliferous sediments (copper, iron, manganese, lead, zinc, barium, cobalt, silver, gold; e.g., Atlantis II Deep of Red Sea)
—Stratiform manganese and iron oxides and hydroxides and iron silicates (e.g., sites on Mid-Atlantic Ridge and Galapagos Spreading Center)
—Polymetallic massive sulfides (copper, iron, zinc, silver, gold, e.g., sites on East-Pacific Rise and Galapagos Spreading Center)
—Polymetallic stockwork sulfides (copper, iron, zinc, silver, gold; e.g., sites on Mid-Atlantic Ridge, Carlsberg Ridge, Costa Rica Rift)
—Other polymetallic sulfides in disseminated or segregated form (copper, nickel, platinum group metals)
—Asbestos
—Chromite
<i>Convergent:</i>
•Offshore
—Uplift sections of oceanic crust containing types of mineral resources formed at divergent plate boundaries (see above)
—Tin, uranium, porphyry copper and possible gold mineralization in granitic rocks
<i>Convergent:</i>
•Onshore
—Porphyry deposits (copper, iron, molybdenum, tin, zinc, silver, gold; e.g., deposits at sites in Andes mountains)
—Polymetallic massive sulfides (copper, iron, lead, zinc, silver, gold, barium; e.g., Kuroko deposits of Japan)
<i>Transform:</i>
•Offshore
—Mineral resources similar to those formed at divergent plate boundaries (oceanic ridges) may occur at offshore transform plate boundaries; e.g., sites on Mid-Atlantic Ridge and Carlsberg Ridge)

SOURCE: Peter A. Rona, "Potential Mineral and Energy Resources at Submerged Plate Boundaries," *MTS Journal*, vol. 19, No. 4, 1985, pp. 18-25.

such as the Hawaiian Islands. These sites may also have significant potential for future recovery of mineral deposits.

The theory of plate tectonics has led to the recognition that many economically important types of mineral deposits are associated with either present or former plate boundaries. Each type of plate boundary—divergent, convergent, or transform—is not only characterized by a distinct kind of interaction, but each is also associated with distinct types of mineral resources (table 2-1). Knowledge of the origin and evolution of a margin can serve as a general guide to evaluating the potential for locating certain types of mineral deposits.

ATLANTIC REGION

When the Atlantic Ocean began to form between Africa and North America around 200 million years ago, it was a narrow, shallow sea with much evaporation. The continental basement rock which formed the edge of the rift zone was block-faulted and the down-dropped blocks were covered with layers of salt and, as the ocean basin widened, with thick deposits of sediment. A number of sedimentary basins were formed in the Atlantic region along the U.S. east coast (figure 2-2). Very deep sedi-

ments are reported to have accumulated in the Baltimore Canyon Trough. In addition, a great wedge of sediment is found on the continental slope and rise. In places, due to the weight of the overlying sediment and density differential, salt has flowed upward to form diapirs or salt domes and is available as a mineral resource. In addition, sulfur is commonly associated with salt domes in the cap rock on the top and flanks of the domes. Both salt and sulfur are mined from salt domes (often by so-

Figure 2-2.—Sedimentary Basins in the EEZ

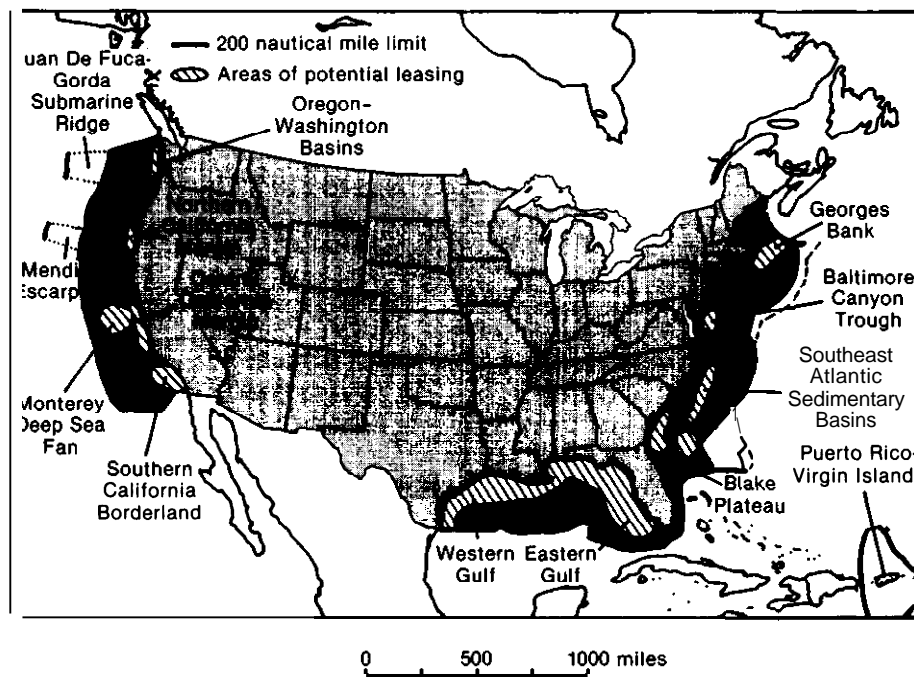
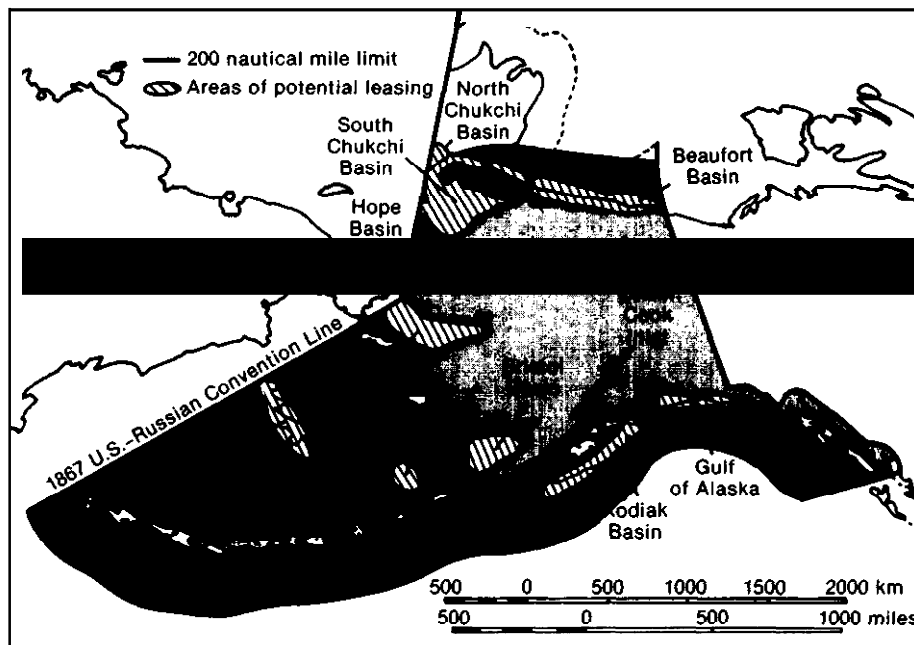

Several basins formed in the EEZ in which great amounts of sediment have accumulated. While of primary interest for their potential to contain hydrocarbons, salt and sulfur are also potentially recoverable from sedimentary basins in the Atlantic and Gulf regions.

SOURCES: Office of Technology Assessment, 1987; U.S. Department of the Interior, "Symposium Proceedings—A National Program for the Assessment and Development of the Mineral Resources of the United States Exclusive Economic Zone," U.S. Geological Survey Circular 929, 1983.

lution mining) and, thus, represent potentially recoverable mineral commodities from offshore deposits, although at present they would not be likely prospects in the Atlantic region.

While they have potential for oil and gas formation and entrapment, the bulk of these sedimentary rocks are not likely to be good prospects for hard minerals recovery because of their depth of burial. Exceptions could occur in very favorable circumstances where a sufficiently high-grade deposit might be found near the surface in less than 300 feet of water or where it could be dissolved and extracted through a borehole. Better prospects, particularly for locating potentially economic and mineable placer deposits, would be in the overlying Pleistocene and surficial sand and gravel.

The igneous and metamorphic basement rocks of the continental shelf, although possible sites of mineral deposits, would be extremely unlikely prospects for economic recovery because of their depth of burial. The oceanic crust that formed under what is now the slope and rise also probably contains accumulations of potential ore minerals, but these too would not be accessible. The best possibility for locating metallic minerals deposits in bedrock in the Atlantic EEZ probably would be in the continental shelf off the coast of Maine where the sediments are thinner or absent and the regional geology is favorable. There are metallic mineral deposits in the region and base-metal sulfide deposits are mined in Canada's New Brunswick.

One other area that may be of interest is the Blake Plateau located about 60 miles off the coasts of Florida and Georgia. It extends about 500 miles from north to south and is approximately 200 miles wide at its widest part, covering an area of about 100,000 square miles. The Blake Plateau is thought to be a mass of continental crust that was an extension of North America left behind during rifting. There is some expectation that microcontinents such as the Blake Plateau might be more mineralized than parent continents or the general ocean-floor, and, because they have received little sediment, their bedrock mineral deposits should be more accessible.

¹K. O. Emery and B. J. Skinner, "Mineral Deposits of the Deep-Ocean Floor," *Marine Mining*, vol. 1 (1977), No. 1/2, pp. 1-71.

Sand and Gravel

Sand and gravel are high-volume but relatively low-cost commodities, which are largely used as aggregate in the construction industry. Beach nourishment and erosion control is another common use of sand. Along the Atlantic coast most sand and gravel is mined from sources onshore except for a minor amount in the New York City area. For an offshore deposit to be economic, extraction and transportation costs must be kept to a minimum. Hence, although the EEZ extends 200 nautical miles seaward, the maximum practical limit for sand and gravel resource assessments would be the outer edge of the continental shelf. However, the economics of current dredging technology necessitate relatively shallow water, generally not greater than 130 feet, and general proximity to areas of high consumption. While these factors would further limit prospective areas to the inner continental shelf regions, they could potentially include almost the entire nearshore region from Miami to Boston.

Sand and gravel are terms used for different size classifications of unconsolidated sedimentary material composed of numerous rock types. The major constituent of sand is quartz, although other minerals and rock fragments are present. Gravel, because of its larger size, usually consists of multiple-grained rock fragments. Sand is generally defined as material that passes through a No. 4 mesh (O. 187-inch) U.S. Standard sieve and is retained on a No. 200 mesh (0.0029-inch) U.S. Standard sieve. Gravel is material in the range of O. 187 to 3 inches in diameter.

Because most uses for sand and gravel specify grain size, shape, type and uniformity of material, maximum clay content, and other characteristics, the attractiveness of a deposit can depend on how closely it matches particular needs in order to minimize additional processing. Thus the sorting and uniformity of an offshore deposit also will be determinants in its potential utilization.

The Atlantic continental shelf varies in width from over 125 miles in the north to less than 2 miles off southern Florida. The depth of water at the outer edge of the shelf varies from 65 feet off the Florida Keys to more than 525 feet on Georges Bank and the Scotian Shelf. A combination of glacial, outwash, subaerial, and marine processes have deter-

Figure 2-3.—Sand and Gravel Deposits Along the Atlantic, Gulf, and Pacific Coasts

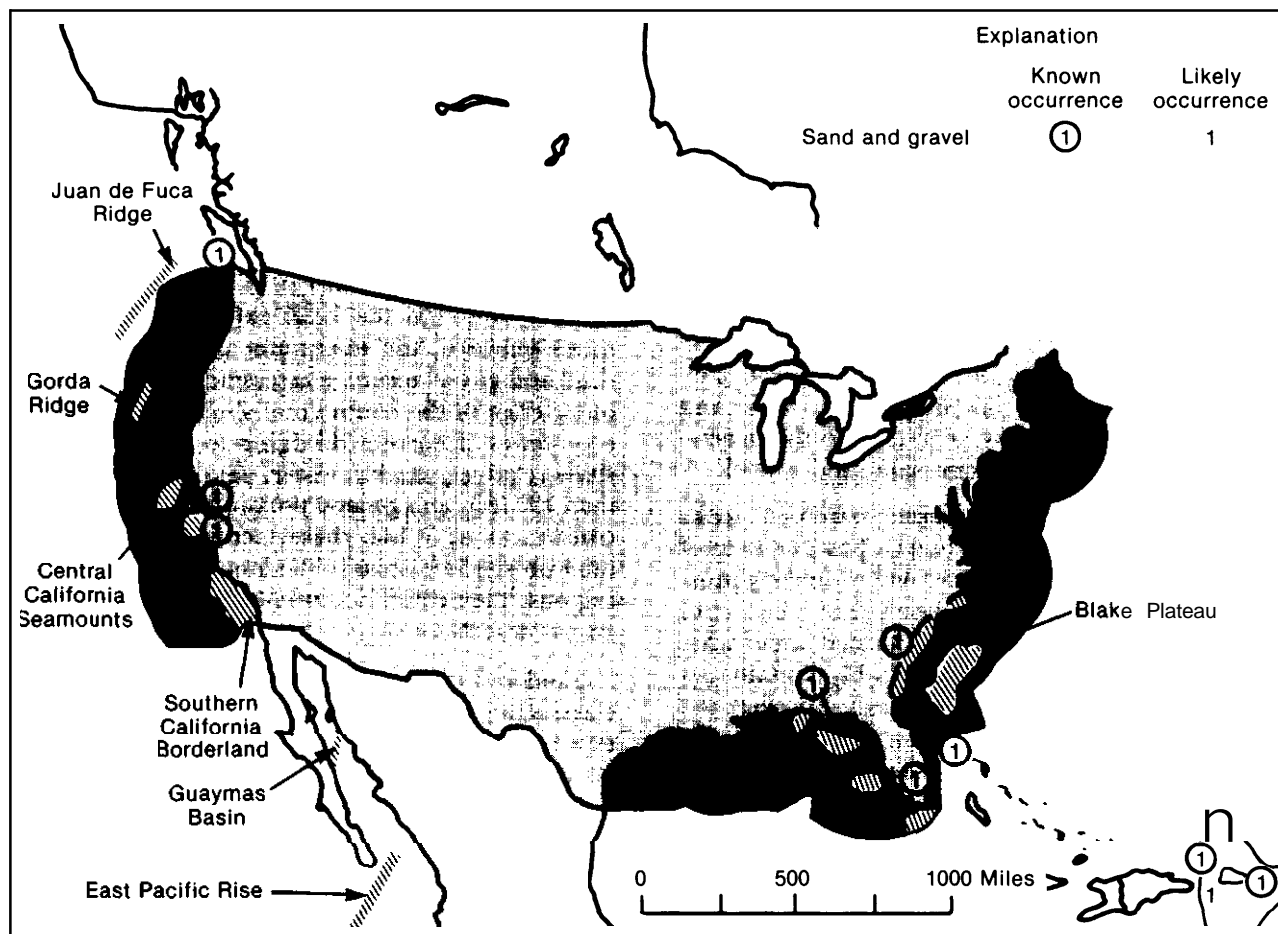

Significant sand and gravel deposits lie on the continental shelf near urban coastal areas. As local onshore supplies of construction aggregate become exhausted, offshore deposits become more attractive. Sand is also needed for beach replenishment and erosion control.

SOURCES: Office of Technology Assessment, 1987; S. Jeffress Williams, "Sand and Gravel—An Enormous Offshore Resource Within the U.S. Exclusive Economic Zone," manuscript prepared for U.S. Geological Survey Bulletin on commodity geology research, edited by John DeYoung, Jr.

mined the general characteristics and distribution of the sand and gravel resources on the shelf.

The northern part of the Atlantic shelf as far south as Long Island was covered by glaciers during the Pleistocene Ice Age. At least four major episodes of glaciation occurred. Glacial deposition and erosion have directly affected the location of sand and gravel deposits in this region. Glacial till and glaciofluvial outwash sand and gravel deposits cover much of the shelf ranging in thickness from over 300 feet to places where bedrock is exposed at the surface. The subsequent raising of sea level has allowed marine processes to rework and redistribute

sediment on the shelf. Major concentrations of gravel in this region are located on hummocks and ridges in the vicinity of Jeffrey's Bank in the Gulf of Maine and off Massachusetts on Stellwagen Bank and in western Massachusetts Bay.

Concentrations of sand are found off Portland, Maine, in the northwestern Gulf of Maine and in Cape Cod Bay northward along the coast through western Massachusetts Bay to Cape Ann (figure 2-3). Large accumulations of sand also occur along the south coast of Long Island and in scattered areas of Long Island Sound. Large sand ridges on Georges Bank and Nantucket Shoals are also an impressive

Figure 2-4.—Plan and Section Views of Shoals Off Ocean City, Maryland

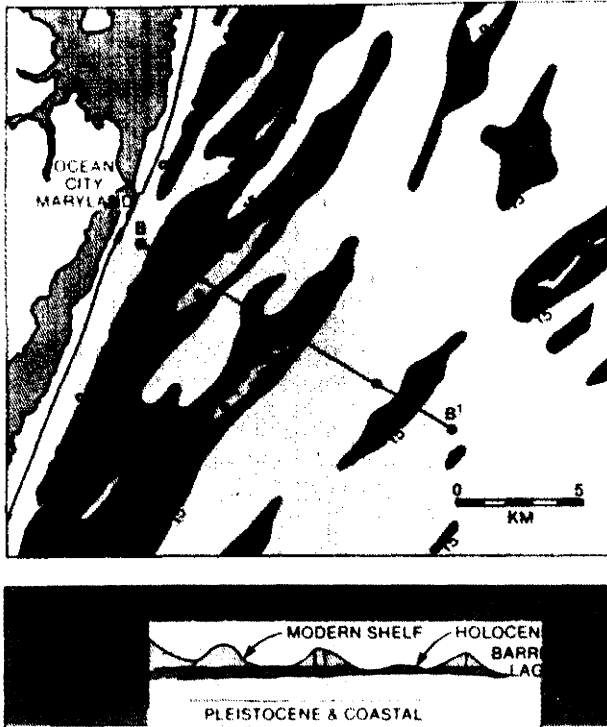

Several drowned barrier beach shoals off the Delmarva Peninsula are potential sources of sand and possibly heavy mineral placers.

SOURCE: S. Jeffress Williams, U. S. Geological Survey

potential resource of medium to coarse sand. These ridges range in height from 40 to 65 feet and in width from 1 to 2 miles, with lengths up to 12 miles. The ridge tops are often at water depths of less than 30 feet, and a single ridge could contain on the order of 650 million cubic yards of sand.

South of Long Island through the mid-Atlantic region, the shelf area was not directly affected by glacial scouring and deposition, but the indirect effects are extensive. During the low stands of sea level, the shelf became an extension of the coastal plain through which the major rivers cut valleys and transported sediment. The alternating periods of glacial advance and marine transgression reworked the sediments on the shelf, yet a number of inherited features remain, including filled channels, relict beach ridges, and inner shelf shoals. Features such as these are particularly common off New Jersey and the Delmarva Peninsula and are poten-

tial sources of sand and possibly gravel (figure 2-4). Seismic profiles and cores indicate that the majority of these shoals consist of medium to coarse sand similar to onshore beaches. Geologic evidence suggests that most of the shoals probably formed in the nearshore zone by coastal hydraulic processes reworking existing sand bodies, such as relict deltas and ebb-tide shoals. Some of the shoals may also represent old barrier islands and spits that were drowned and left offshore by the current marine transgression. Typical shoals in this region are on the order of 30 to 40 feet high, are hundreds of feet wide, and extend for tens of miles. South of Long Island, gravel is much less common and found only where ancestral river channels and deltas are exposed on the surface and reworked by moving processes.

The southern Atlantic shelf from North Carolina to the tip of Florida was even further removed from the effects of glaciation and also from large volumes of fluvial sediment. The shelf is more thinly covered with surficial sand, and outcrops of bedrock are common. Furthermore, unlike the middle Atlantic region, the southern shelf is not cut by river channels and submarine canyons. Sand resources in this region are described as discontinuous sheets or sandy shoals with the carbonate content (consisting of shell and coral fragments, limestone grains, and oolites) increasing to the south.

Although there is more information on the Atlantic EEZ than on other portions of the U.S. EEZ, estimates of sand and gravel resources on the Atlantic continental shelf are limited by a paucity of data. Resource estimates have been made using assumptions of uniform distribution and average thickness of sediment but these are rough approximations at best since the assumptions are known to be overly simplistic. A number of specific areas have been cored and studied in sufficient detail by the U.S. Army Corps of Engineers to make local resource estimates.⁷ Resource assessments of specific sand deposits on the Atlantic shelf in water

⁶S. J. Williams, "Sand and Gravel Deposits Within the U.S. Exclusive Economic Zone: Resource Assessment and Uses," *Proceedings of the 18th Annual Offshore Technology Conference*, Houston, TX, May 5-8, 1986, pp. 377-386.

⁷D. B. Duane and W. L. Stubblefield, "Sand and Gravel Resources, U.S. Continental Shelf," *Geology of North America: Atlantic Region, U.S.*, Ch. XI-C, Geological Society of America, *Decade of North American Geology* (in press).

Table 2=2.—Areas Surveyed and Estimated Offshore Sand Resources of the United States

Geographic area	Seismic miles	Cores	Area surveyed (mile ²)	Sand volume (x 10 ⁹ cubic yards)
New England:				
Maine			10	123
Massachusetts (Boston).			175	57
Rhode Island			25	141
Connecticut (Long Island Sound).			50	130
Area totals	1,900	280	260	531
Southshore Long Island:				
Gardiners-Napeague Bays			100	162
Montauk to Moriches Inlet			160	1,912
Moriches to Fire Island Inlet			350	2,404
Fire island to East Rockaway Inlet			125	1,359
Rockaway			50	1,031
Area totals	955	122	785	6,868
New Jersey:				
Sandy Hook	255	10	50	1,000
Manasquan	86	11	25	60
Barnegat	200	32	75	448
Little Egg	389	38	120	180
Cape May.....	760	107	340	1,880
Area totals	1,660	198	610	3,568
Virginia:				
Norfolk	260	57	180	20
Delmarva.	435	78	310	225
North Carolina.	734	112	950	218
Florida:				
Northern:				
Fernandina—Cape Canaveral	1,328	197	1,650	295
Southern:				
Cape Canaveral	356	91	350	2,000
Cape Canaveral—Palm Beach	611	72	450	92
Palm Beach—Miami	176	31	141	581
Area totals	2,471	391	2,591	2,673
California:				
Newport-Pt. Dume	360	69	140	491
Pt. Dume—Santa Barbara	145	34	90	90
Area totals	505	103	230	599
Hawaii				
	Unknown	Unknown	Unknown	Unknown
Great Lakes:				
Erie	Unknown	Unknown	Unknown	Unknown
Grand totals	8,920	1,341	7,266	15,011

SOURCES: Published and unpublished reports of U.S. Army Corps of Engineers Coastal Engineering Research Center: David B. Duane, "Sedimentation and Ocean Engineering: Placer Mineral Resources," *Marine Sediment Transport and Environmental Management*, D.J. Stanley and D.J.P. Swift(eds) (New York, NY: John Wiley&Sons, 1976), p. 550.

depth of 130 feet or less are included in table 2-2. A total of over 15 billion cubic yards of commercial quality sand are identified in the table, and it is fair to say that the potential for additional amounts is large. Since the current annual U.S. consumption of sand and gravel is about 1,050 million cubic yards, these resources would clearly be ample to meet the needs of the east coast for the foreseeable future.

Placer Deposits

Offshore placer deposits are concentrations of heavy detrital minerals that are resistant to the chemical and physical processes of weathering. Placer deposits are usually associated with sand and gravel as they are concentrated by the same fluvial and marine processes that form gravel bars, sandbanks, and other surficial features. However,

because they have different hydraulic behavior than less dense materials they can become concentrated into mineable deposits.

In addition to hydraulic behavior, a number of other factors influence the distribution and character of placer deposits on the continental shelf and coastal areas. These factors include sources of the minerals, mechanisms for their erosion and transport, and processes of concentration and preservation of the deposits.

While placer minerals can be derived from previously formed, consolidated, or unconsolidated sedimentary deposits, their primary source is from igneous and metamorphic rocks. Of these rocks, those that had originally been enriched in heavy minerals and were present in sufficiently large volumes would provide a richer source of material for forming valuable placer deposits. For example, chromite and platinum-group metals occur in ultramafic rocks such as dunite and peridotite, and the proximity of such rocks to the coast would enhance the possibility of finding chromite or platinum placers. While small podiform peridotite deposits are found from northern Vermont to Georgia, ultramafic rocks are not overly common in the Atlantic coastal region. Consequently, the prospects for locating chromite or platinum placers in surficial sediments of the Atlantic shelf would be low. Other rock types, such as high-grade metamorphic rocks, would be a likely source of titanium minerals such as rutile, and high-grade metamorphic rocks are found throughout the Appalachians. Placer deposits are generally formed from minerals dispersed in rock units, when great amounts of rock have been reduced by weathering over very long periods of time.

Time is a factor in the formation of placer deposits in several respects. In addition to their chemistry, the resistance of minerals to weathering is time and climate dependent. In a geomorphologically mature environment where a broad shelf is adjacent to a wide coastal plain of low relief, such as the middle and southern Atlantic margin, the most resistant heavy minerals will be found to dominate placer deposit composition. These would include the chemically stable placer minerals such as the precious metals, rutile, zircon, monazite, and tourmaline. Less resistant heavy minerals, such as amphiboles, garnets, and pyroxenes, which

are more abundant in igneous rock, dominate heavy mineral assemblages in more immature tectonically active areas such as the Pacific coast. These minerals are currently of less economic interest.

Placer deposits are frequently classified into three groups based on their physical and hydraulic characteristics. The first group is the heaviest minerals such as gold, platinum, and cassiterite (tin oxide). Because of their high specific gravities, which range from 6.8 to 21, these minerals are deposited fairly near their source rock and tend to concentrate in stream channels. For gold and platinum, the median distance of transport is probably on the order of 10 miles.⁸ Heavy minerals with a lighter specific gravity, in the range of 4.2 to 5.3, form the second group and tend to concentrate in beach deposits; but they also can be found at considerable distances from shore in areas where sediments have been worked and reworked through several erosional and depositional cycles. Minerals of economic importance in this group include chromite, rutile, ilmenite, monazite, and zircon.⁹ The third group is the gemstones of which diamonds are the major example. These are very resistant to weathering, but are of relatively low specific gravity in the range of 2.5 to 4.1.

As a first step in assessing placer minerals resources potential in the Canadian offshore, a set of criteria was developed and the criteria were listed according to their relative importance. A ranking scheme was then adopted to assess the implications of each criterion with regard to the likelihood of a placer occurring offshore (table 2-3). This approach can be applied to the U.S. EEZ.

⁸K. O. Emery and L.C. Noakes, "Economic Placer Deposits on the Continental Shelf, United Nations Economic Commission for Asia and the Far East, *Technical Bulletin*, vol. 1, 1968, pp. 95-111.

⁹Rutile and ilmenite are major titanium minerals (along with leucocoxene), and monazite is a source of yttrium and rare earth elements which have many catalytic applications in addition to uses in metallurgy, ceramics, electronics, nuclear engineering, and other areas. Zircon is used for facings on foundry molds, in ceramics and other refractory applications, and in several chemical products. Zircon is also processed for zirconium and hafnium metal, which are used in nuclear components and other specialized applications in jet engines, reentry vehicles, cutting tools, chemical processing equipment, and superconducting magnets.

¹⁰P. B. Hale and P. McLaren, "A Preliminary Assessment of Unconsolidated Mineral Resources in the Canadian Offshore, *CIM Bulletin*, September 1984, p. 11.

Table 2-3.—Criteria Used in the Assessment of Placer Minerals

Criterion	Implication ^a	Information required
		Types and sources
1. Presence in marine sediments of interest	+ + + Direct evidence	Onsite bottom samples
2. Mineral presence in onland unconsolidated deposits close to the shoreline	+ + + Alluvial sediments in seaward flowing watershed in glacial deposit	Historical placer mining records, geological reports
3. Presence of drowned river channels and strandlines offshore of coastal host rocks	+ +	High-resolution seismic surveys, detailed hydrographic surveys
4. Occurrence in source rock close to shore	+ + + No watershed but previously glaciated with offshore ice movement	CANMINDEX geological reports, mining records, topographic maps, surficial geology maps
5. Presence of unconsolidated sediments seaward of onland host rocks	+	Offshore surficial geology maps, seismic records
6. Evidence of preglacial regoliths and mature weathering of bedrock	+	Reports of residual deposits and earlier formed regoliths
7. Sea-level fluctuations:		
(i) Transgression	+	For preservation of relict fluvial placers now submerged
(ii) Stable sea level	+	For formation of a contemporary beach placer
(iii) Regression	+	For formation of a contemporary river mouth placer
8. High-energy marine	+	For formation of a contemporary placer
	-	For preservation of a relict placer
9. Previously glaciated		Glacial ice tends to scour out, disseminate or bury the heavy minerals
	+	In some circumstances glaciation liberates heavy minerals and transports them to considerable distance to the offshore
10. Ice cover		Generally the longer the ice-free period the greater potential to generate a marine placer
11. Circulation patterns	+	
12. Climate	+	Important to the maturity of the mineral assemblage

^aA relative ranking scheme was adopted to assess the implications of each factor with regards to the likelihood of a placer occurring in the offshore. Favorable indications are as follows: + + + extremely favorable, + + + very favorable and, + favorable. Factors likely to detract from the possibility of an offshore placer utilize a similar approach with a negative sign.

SOURCE: Modified from Peter B. Hale and Patrick McLaren, "A Preliminary Assessment of Unconsolidated Mineral Resources in the Canadian Off shore," *C/M Bulletin*, September 1954, p. 7.

Recent studies of heavy minerals in Atlantic continental shelf sediments have found mineral assemblages in the north Atlantic region dominated by less chemically stable minerals. The relatively immature mineral assemblages result from the direct glaciation that the northern shelf recently received. In general, glacial debris is less well sorted and often contains fresher mineral assemblages than sediment, which has been exposed to fluvial transport

and weathering processes over a long period of time. While data for the north Atlantic region are too limited to be conclusive in terms of potential resources, greater concentrations of heavy minerals are found south of Long Island (figure 2-5). Total heavy mineral concentrations in the middle Atlantic region reach 5 percent or more in some areas, and the mineral assemblages show a greater degree of weathering. In comparison to the northern regions,

Figure 2-5.—Atlantic EEZ Heavy Minerals

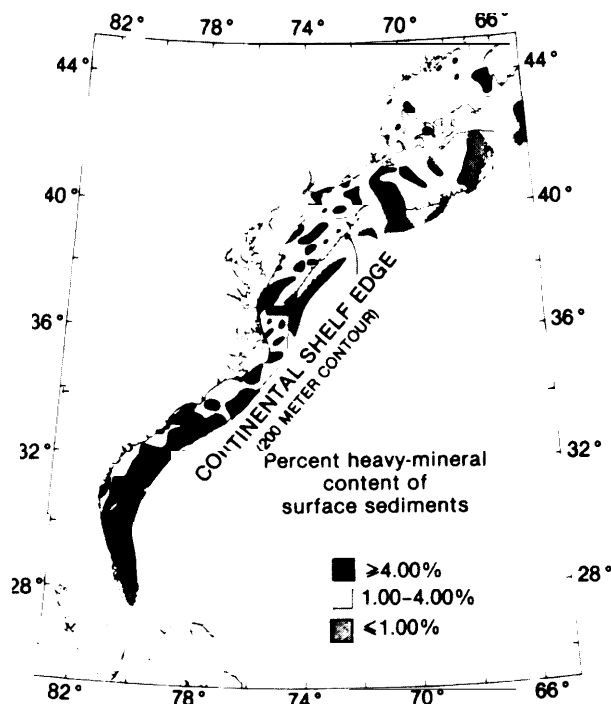

Several areas of the Atlantic EEZ contain high concentrations of heavy minerals in the surficial sediments. Further research is needed to determine the extent of these deposits and possible economic potential.

SOURCES: Office of Technology Assessment, 1987; A.E. Grosz, J.C. Hathaway, and E.C. Escowitz, "Placer Deposits of Heavy Minerals in Atlantic Continental Shelf Sediments," Proceedings of the 18th Annual Offshore Technology Conference, Houston, Texas, OTC 5198, May 1988.

sediments of the southern Atlantic region contain lower concentrations of heavy minerals, but the assemblage becomes progressively more mature to the south and, hence, more concentrated in heavy minerals of more economic interest such as titanium.¹¹ This situation suggests that the mineral composition of the southern Atlantic shelf region holds the best prospects for economically attractive deposits.

Precious Metals

Although, in general, the north Atlantic region may have relatively poor prospects for economic placer deposits compared to the southern region,

¹¹A. E. Grosz, J. C. Hathaway, and E. C. Escowitz, "Placer Deposits of Heavy Minerals in Atlantic Continental Shelf Sediments," Proceedings of the 18th Annual Offshore Technology Conference, Houston, TX, May 5-8, 1986, pp. 387-394.

it might possibly be the most favorable area along the Atlantic EEZ for gold placers. Gold occurrences have been found in a variety of rocks along the Appalachians and in the maritime provinces of Canada, and both lode and placer gold deposits have been worked in areas that drain toward the coast. Because of its high specific gravity, placer gold is expected to be near its point of origin, which would be nearer to the coast in the New England area than in southern areas where broad coastal plains are developed. Further, glacial scouring and movement could have brought gold-bearing sediment offshore where it could be reworked and the gold concentrated by marine processes. While the prospects for gold placers are poor in the Atlantic EEZ, gold placers have been found on the coastal plain in the mid- and south Atlantic regions. To reach the EEZ in those regions, gold would have been transported by fluvial processes a considerable distance from its source and, if found, probably would be very fine-grained.

Heavy Minerals—Titanium Sands

The major area of interest for economic placer deposits, particularly titanium minerals, would be the middle and south Atlantic EEZ. Again the criteria in table 2-3 are useful. Concentrations of the commercially sought heavy minerals have been found in the sediments offshore (criterion 1) and titanium minerals mined onshore (criterion 2). In addition, several other criteria are also evident. These indicators would suggest a good potential for placer deposits offshore. An interesting aspect of this, however, is a reconnaissance study by the U.S. Geological Survey (USGS) that found significant concentrations of heavy minerals in surface grab-samples offshore of Virginia, where no economic deposits are found onshore.¹² However, rich rutile and ilmenite placer deposits have been mined in the drainage basin of the James River, a tributary of Chesapeake Bay. These deposits had their source in anorthosite and gneisses of the Virginia Blue Ridge.¹³ An earlier study, which had found high

¹²A. E. Grosz and E. C. Escowitz, "Economic Heavy Minerals of the U.S. Atlantic Continental Shelf, W. F. Tanner (ed.), Proceedings of the Sixth Symposium on Coastal Sedimentology, Florida State University, Tallahassee, FL, 1983, pp. 231-242.

¹³J. P. Minard, E. R. Force, and G. W. Hayes, "Alluvial Ilmenite Placer Deposits, Central Virginia," U.S. Geological Survey Professional Paper 959-H, 1976.

concentrations of heavy minerals parallel to the present shoreline off the Virginia coast in water depths between 30 and 60 feet, hypothesized sources from the Chesapeake Bay and the Delaware River.¹⁴ The deposit was thought to be a possible ancient strandline where the heavy minerals were concentrated by hydraulic fractionation.

Bottom topography may be an important clue to surface concentrations of heavy minerals. One investigation off Smith Island near the mouth of Chesapeake Bay found high concentrations of heavy minerals on the surface of a layer of fine sand that was distributed along the flanks of topographic ridges.¹⁵ However, coring data are needed to provide information on the vertical distribution of placer minerals and on whether or not similar buried topography is preserved and contains similar heavy mineral concentrations.

Overall, the south Atlantic EEZ would be a favorable prospective region for titanium placers, based on maturity of heavy mineral assemblages, although sediment cover is thinner and more patchy than farther north. However, individual features such as submerged sand ridges could contain concentrated deposits.

As with sand and gravel, regional resource estimates are probably not very useful since they are based on gross generalizations. This caveat notwithstanding, recent studies indicate that the average heavy mineral content of sediments on the Atlantic shelf is on the order of 2 percent, and that the total volume of sand and gravel may be larger than earlier estimates.^{16, 17} These studies suggest that whatever the total offshore resource base is estimated to be, the southern Atlantic EEZ may hold considerable promise for titanium placer deposits of future interest, particularly in areas of paleo-stream channels where there are major gaps in the

Trail Ridge formation (a major onshore titanium sand deposit). In any event, only high-grade, accessible deposits would be potentially attractive, and the total heavy mineral assemblage would determine the economics of the deposit.

Phosphorite Deposits

Sedimentary deposits consisting primarily of phosphate minerals are called phosphorites. The principal component of marine phosphorites is carbonate fluorapatite. Marine phosphorites occur as muds, sands, nodules, plates, and crusts, generally in water depths of less than 3,300 feet. Phosphatic minerals are also found as cement bonding other detrital minerals. Marine phosphorite deposits are related to areas of upwelling and high bioproductivity on the continental shelves and upper slopes, particularly in lower latitudes.

Bedded phosphorite deposits of considerable areal extent are of major economic importance in the Southeastern United States. The bedded deposits in the Southeastern United States are related to multiple depositional sequences in response to transgressive and regressive sea level changes.¹⁸ Major phosphate formation in this region began about 20 million years ago during the Miocene. Low-grade phosphate deposits are found in younger surficial sediments on the continental shelf, but these are largely reworked from underlying units. While these surface sediments are probably not of economic interest, they may be important tracers for Miocene deposits in the shallow subsurface.

On the Atlantic shelf, the northernmost area of interest for phosphate deposits is the Onslow Bay area off North Carolina. (Concentrations of up to 19 percent phosphate have been reported in relict sediments on Georges Bank, but these are unlikely to be of economic interest.) In the Onslow Bay area, the Pungo River Formation outcrops in an northeast-southwest belt about 95 miles long by 15 to 30 miles wide and extends into the subsurface to the east and southeast. The Pungo River Formation is a major sedimentary phosphorite unit under the north-central coastal plain of North Caro-

¹⁴B.K. Goodwin and J. B. Thomas, "Inner Shelf Sediments Off of Chesapeake Bay III, Heavy Minerals," *Special Scientific Report No. 68, Virginia Institute of Marine Science, 1973, p. 34.*

¹⁵C. R. Berquist and C. H. Hobbs, "Assessment of Economic Heavy Minerals of the Virginia Inner Continental Shelf," *Virginia Division of Mineral Resources Open-File Report 86-1, 1986, p. 17.*

¹⁶US Department of the Interior, *Program Feasibility Document, OCS Hard Minerals Leasing, prepared for the Assistant Secretaries of Energy and Minerals and Land and Water Resources by the OCS Mining Policy Phase II Task Force, August 1979, Executive Summary, p. 40.*

¹⁷Grosz, Hathaway, and Esowitz, "Placer Deposits of Heavy Minerals in Atlantic Continental Shelf Sediments," p. 387,

¹⁸S. R. Riggs, D. W. Lewis, A. K. Scarborough, et al., "Cyclic Deposition of Neogene Phosphorites in the Aurora Area, North Carolina, and Their Possible Relationship to Global Sea-Level Fluctuations," *Southeastern Geology, vol. 23, No. 4, 1982, pp. 189-204.*

lina. Five beds containing high phosphate values have been cored in two areas of Onslow Bay. The northern area harboring three phosphate beds contains an estimated resource of 860 million short tons of phosphate concentrate with average phosphorus pentoxide (P_2O_5) values of 29.7 to 31 percent. The P_2O_5 content of the total sediment in these beds ranges from 3 to 6 percent. The Frying Pan area to the south contains two richer beds estimated to contain 4.13 billion tons of phosphate concentrate with an average content of 29.2 percent P_2O_5 .¹⁹ The P_2O_5 content of the total sediment in these beds ranges from 3 to 21 percent. Of the two areas, the Frying Pan district is given a better potential for economic development. The deposits are in shallow water relatively close to shore.

Further to the south, from North Carolina to Georgia, phosphates occur on the shelf in relict sands. Phosphate grain concentrations of 14 to 40 percent have been reported in water depths of 100 to 130 feet. On the Georgia shelf off the mouth of the Savannah River, a deposit of phosphate sands over 23 feet thick has been drilled. Other deposits near Tyber Island, off the coast of Georgia, include a 90-foot-thick bed of phosphate in sandy clay averaging 32 percent phosphate overlying a 250-foot thick bed of phosphatic limestone averaging 23 percent phosphate. Concerns over saltwater intrusion into an underlying aquifer may constrain potential development in this area.

Further offshore, the Blake Plateau is an area of large surficial deposits of manganese oxides and phosphorites (figure 2-6). The Plateau is swept by the Gulf Stream and water depth ranges from 2,000 feet on the northern end to nearly 4,000 feet on the southeastern end. Phosphorite occurs in the shallower western and northern portions as sands, pellets, and concretions. The northern portion of the Blake Plateau is estimated to contain 2.2 billion tons of phosphorite.²⁰

Off the Florida coast near Jacksonville, deep and extensive sequences of phosphate-rich sediments ex-

tend eastward onto the shelf. One bed, 20 feet thick beneath 260 feet of overburden, containing 70 to 80 percent phosphate grains, was slurry test-mined in this area. A core hole 30 miles east of Jacksonville contained a 11 5-foot section of cyclic phosphate-rich beds with the thickest unit up to 16 feet thick. The phosphate facies ran between 30 and 70 percent phosphate grains.

Deep drill data in the Osceola Basin have shown two phosphate zones extending eastward onto the continental shelf. The lower grade upper zone is 1,000 feet thick with 140 feet of overburden and phosphate grain concentrations of 10 to 50 percent of the total sediment. The higher grade deeper zone is 82 feet thick with 250 feet of overburden and phosphate grain concentrations ranging from 25 to 75 percent of total sediment.

The Miami and Pourtales Terraces off the southeast coast of Florida are also known to have phosphate occurrences. On the Pourtales Terrace, phosphorite occurs as conglomerates, phosphatic limestone, and phosphatized marine mammal bones. This deposit is thought to be related to the phosphatic Bone Valley Formation onshore.

Manganese Nodules and Pavements

Ferromanganese nodules are concretions of iron and manganese oxides containing nickel, copper, cobalt, and other metals that are found in deep ocean basins and in some shallower areas such as the Blake Plateau off the Southeastern United States. On the Blake Plateau, nodule concretions are found at depths of 2,000 to 3,300 feet; and their centers commonly are phosphoritic. Ferromanganese crusts and pavements are more common at shallower depths of around 1,600 feet. The ferromanganese concretions of the Blake Plateau are well below the metal values found in the prime nodule sites in the Pacific Ocean, but the Blake Plateau offers the advantages of much shallower depths and proximity to the U.S. continent. Potential ferromanganese nodule resources on the Blake Plateau are estimated to be on the order of 250 billion tons averaging 0.1 percent copper, 0.4 percent nickel, 0.3 percent cobalt, and 15 percent manganese.²¹

¹⁹ S. R. Riggs, S. W. P. Snyder, A. C. Hine, et al., "Geologic Framework of Phosphate Resources in Onslow Bay, North Carolina Continental Shelf," *Economic Geology*, vol. 80, 1985, pp. 716-738.

²⁰ F. T. Manheim, "Potential Hard Mineral and Associated Resources on the Atlantic and Gulf Continental Margins," *Program Feasibility Document—OCS Hard Minerals Leasing*, app. 12, U.S. Department of Interior, 1979, p. 42.

²¹ *Ibid.*, p. 15.

Figure 2-6.—Potential Hard Mineral Resources of the Atlantic, Gulf, and Pacific EEZs

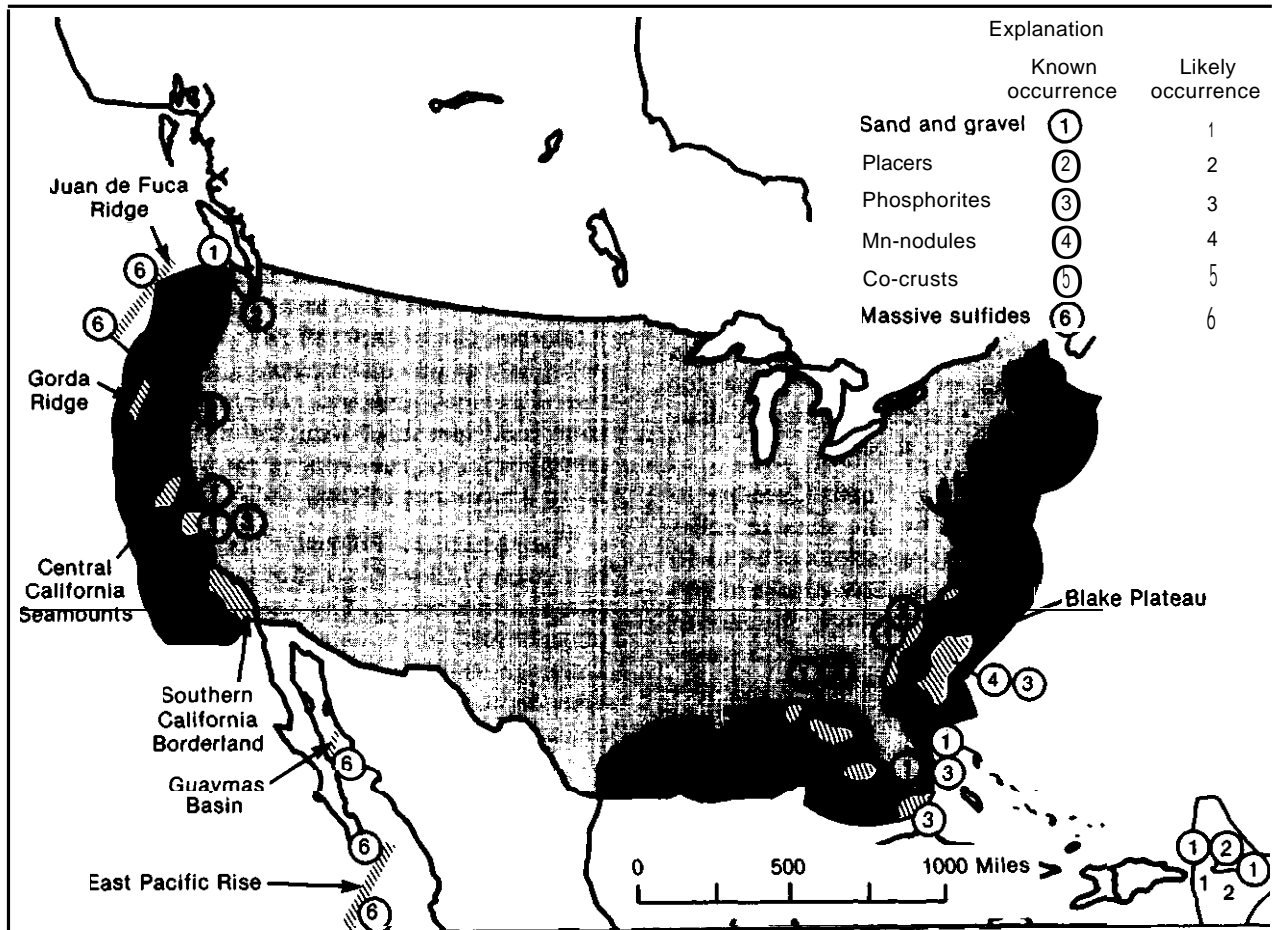

SOURCES: Office of Technology Assessment, 1987; U.S. Department of the Interior, "Symposium Proceedings—A National Program for the Assessment and Development of the Mineral Resources of the United States Exclusive Economic Zone," U.S. Geological Survey Circular 929, 1983.

PUERTO RICO AND THE U.S. VIRGIN ISLANDS

Puerto Rico and the U.S. Virgin Islands are part of an island arc complex with narrow insular shelves. The geologic environment of this type of active plate boundary suggests that sand and gravel deposits would not be extensive and that placer mineral assemblages would be relatively immature.

Sand and Gravel

Modern and relict nearshore delta deposits are the main source of offshore sediment for both Puerto Rico and the U.S. Virgin Islands. Further offshore the elastic sediments contain increasing

amounts of carbonate material. In general, the islands lack large offshore sand deposits because wave action and coastal currents tend to rework and transport the sand across the narrow shelves into deep water. Submarine canyons also play a role in providing a conduit through which sand migrates off the shelf. The outer edge of the shelves is at a water depth of around 330 feet.

Three major sand bodies are located on the shelf of Puerto Rico in water depths of less than 65 feet. As one might expect in an area of westward moving winds and water currents, all three deposits are at the western ends of islands. Inferred resources

have been calculated for two of these areas, the Cabo Rojo area off the west end of the south coast of Puerto Rico and the Escollo de Arenas area north of the west end of Vieques Island (near the east coast of Puerto Rico). The total volume of sand in these deposits is estimated at 220 million cubic yards, which could supply Puerto Rico's construction needs for over 20 years.²²

In the U.S. Virgin Islands, several sand bodies contain an estimated total of 60 million cubic yards. Some of the more promising are located off the southwest coast of St. Thomas, near Buck Island, and on the southern shelf of St. Croix.

²²R. W. Rodriguez, 'Submerged Sand Resources of Puerto Rico in USGS Highlights in Marine Research, USGS Circular 938, 1984, pp. 57-63.

Placer Deposits

Heavy mineral studies along the north coast of Puerto Rico found a strong seaward sorting with relatively heavy minerals such as monazite and magnetite enriched on the inner shelf relative to pyroxenes and amphiboles. The high degree of nearshore sorting may indicate a likelihood of the occurrence of placers, particularly in the inner shelf zone.²³ Gold has been mined in the drainage basin of the Rio de La Plata which discharges to the north coast of Puerto Rico, although no gold placers as yet have been found on the coast.

²³O. H. Pilkey and R. Lincoln, "Insular Shelf Heavy Mineral Partitioning Northern Puerto Rico," *Marine Mining*, vol. 4, No. 4, 1984, pp. 403-414.

GULF OF MEXICO REGION

The Gulf of Mexico is a small ocean basin whose continental margins are structurally complex and, in some cases, rather unique. The major structural feature of the U.S. EEZ in the northern Gulf of Mexico is the vast amount of sediment that accumulated while the region was subsiding. The structural complexity of the northern Gulf margin was enhanced by the mobility of underlying salt beds that were deposited when the region was a shallow sea. In general, the sedimentary beds dip and thicken southward and are greatly disrupted by diapiric structures and by flexures and faults of regional extent.

Sulfur and salt are both recovered from bedded evaporite deposits and salt domes in the Gulf region. Sulfur is generally extracted by the Frasch hot water process, which is easily adaptable to operation from an offshore platform. Sulfur has been recovered from offshore Louisiana and could be more widely recovered from offshore deposits if the market were favorable.

Sand and Gravel

The sand and gravel resources of the Gulf of Mexico are even more poorly characterized than the Atlantic EEZ. Most of the shallow sedimentary and geomorphological features of the Gulf were similarly developed as a result of the sea-level fluctuations during the Quaternary.

The Mississippi River dominates the sediment discharge into the northern Gulf of Mexico. Over time, the Mississippi River has shifted its discharge point, leaving ancestral channels and a complex delta system. As channels shift, abandoned deltas and associated barrier islands are reworked and eroded, forming blanket-type sand deposits and linear shoals.²⁴ A number of these shoals having a relief of 15 to 30 feet are found off Louisiana. Relict channels and beaches are also good prospects for sand deposits. Relict channels and deltas have been identified off Galveston, containing over 78 million cubic yards of fine grained sand which may have uses for beach replenishment or glass sand. Sand and gravel resource estimates for the U.S. EEZ are given in table 2-4. Based on an average thickness of 16 feet, these are projected to be around 350 billion cubic yards of sand for the Gulf EEZ. No gravel resources are identified on the Gulf shelf although offshore shell deposits are common and have been mined as a source of lime. Until more surveys aimed at evaluating specific sand and gravel deposits are conducted, resource estimates are little more than an educated guess. In any event, the resource base is large, although meeting coarser size specifications may be a limiting factor in some areas.

²⁴Williams, 'Sand and Gravel Deposits Within the United States Exclusive Economic Zone, p. 381.

Table 2-4.—Estimates of Sand and Gravel Resources Within the U.S. Exclusive Economic Zone

Province	Volumes (cubic meters)
Atlantic:	
Maine—Long Island	340 billion
New Jersey—South Carolina	190 billion
South Carolina—Florida	220 billion
Gulf of Mexico	269 billion
Caribbean:	
Virgin Islands	> 46 million
Puerto Rico	170 million
Pacific:	
Southern California	30 billion
Northern California—Washington	insufficient data
Alaska	> 160 billion
Hawaii	19 billion

SOURCE: Modified after S.J. Williams, "Sand and Gravel Deposits Within the United States Exclusive Economic Zone: Resource Assessment and Uses," 18th Annual Offshore Technology Conference, Houston, TX, 1986, pp. 377-386.

Placer Deposits

Although reconnaissance surveys have not been conducted over much of the region, concentrations of heavy minerals have been found in a number of locations in the Gulf of Mexico. Several offshore sand bars or shoals are found off Dog Island, Saint George Island, and Cape San Bias in northwestern Florida that may contain concentrations of heavy minerals.²⁵ Some of these shoals are believed to be drowned barrier islands.

One recent survey of the shelf off northwest Florida found heavy mineral concentrations associated with shoal areas offshore of Saint George and Santa Rosa Islands.²⁶ The heavy minerals of eco-

²⁵W. E. Tanner, A. Mullins, and J. D. Bates, "Possible Masked Heavy Mineral Deposit: Florida Panhandle," *Economic Geology*, vol. 56, 1961, pp. 1079-1087.

²⁶J. D. Arthur, S. Melkote, J. Applegate, et al., "Heavy Mineral Reconnaissance Off the Coast of the Apalachicola River Delta, Northwest Florida," Florida Bureau of Geology in Cooperation with U.S. Minerals Management Service, Contract No. 14-12-001-30115, Aug. 16, 1985 (unpublished).

nomically interesting totaled about 39 percent of the heavy mineral fraction averaged over the study area. However, the percentages of heavy minerals and the composition of the heavy mineral sites reported are lower and of less economic interest, respectively, than those on the Atlantic shelf. Sediments derived from the Mississippi River off Louisiana contain heavy mineral fractions in which ilmenite and zircon are concentrated. In the western part of the Gulf, less economically interesting heavy minerals of the amphibole and pyroxene groups are dominant.²⁷

An aggregate heavy-mineral sand resource estimate was not attempted for the gulf coast as part of the Department of the Interior's Program Feasibility Study for Outer Continental Shelf hard minerals leasing done in 1979. Too little data are available and aggregate numbers are not very meaningful in terms of potentially recoverable resources.

Phosphorite Deposits

Recent seismic studies indicate that the phosphate-bearing Bone Valley Formation extends at a relatively shallow depth at least 25 miles into the Gulf of Mexico and the west Florida continental shelf. An extensive Miocene sequence also extends across the shelf, and Miocene phosphorite has been dredged from outcrops on the mid-slope. This situation would suggest that the west Florida shelf may have considerable potential for future phosphate exploration.²⁸ Core data would be needed to assess this region more fully.

²⁷R. G. Bannock and M. J. Cruickshank, "Placer Minerals on the U.S. Continental Shelves—Opportunity for Development," *Proceedings OCEANS '83*, vol. II, 1983, pp. 698-702.

²⁸W. C. Burnett, "Phosphorites in the U.S. Exclusive Economic Zone," *Proceedings, the Exclusive Economic Zone Symposium Exploring the New Ocean Frontier*, held at Smithsonian Institution, Washington, DC, October 1985 (Washington, DC: U.S. Department of Commerce, May 1986), pp. 135-140.

PACIFIC REGION

The continental margin along the Pacific coast and Alaska has several subregions. Southern California, from Mexico northward to Point Conception, is termed a "borderland, a geomorphic ex-

tensional complex of basins, islands, banks, ridges, and submarine canyons. Tectonically, this region is undergoing lateral or transform movement along the San Andreas fault system. The offshore base-

ment (deep) rocks include metasediments, schist, andesites, and dacites. Thick sequences of Tertiary sediments were deposited in deep marine basins throughout the region. The shelf is fairly narrow (3 to 12 miles) and is transected by several submarine canyons extending to the edge of the shelf. From Point Conception north along the mountainous coast to Monterey Bay, the shelf is quite narrow in places, but north of San Francisco to Cape Mendocino it widens again to 6 to 25 miles. The coast in this area is generally rugged with a few lowland areas along river valleys. Wave energy is high along the entire coast and uplifted wave-cut terraces indicating former higher stands of sea level are common.

Northward along the coast of Oregon, the continental shelf is as narrow as 6 miles and averages less than 18 miles in width. Off Washington, the shelf gradually widens to over 30 miles and is underlain by a varied terrain of sedimentary rocks, mafic and ultramafic intrusive, and granite rocks. The Washington coast also has been influenced by glaciation, and glacial till and alluvium extend out onto the shelf. The Columbia River is a major source of sediment in the southern Washington and northern Oregon region. Beyond the shelf, but within the U.S. EEZ, the seafloor spreading centers of the Gorda and Juan de Fuca ridges and related subduction zones at the base of the continental slope contribute to the tectonic activity of the region.

Sand and Gravel

The narrow continental shelf and high wave energy along the Pacific coast limit the prospects for recovering a great abundance of sand and gravel from surficial deposits. In southern California, deposits of sand and gravel at water depths shallow enough to be economic are present on the San Pedro, San Diego, and Santa Monica shelves. Most coarse material suitable for construction aggregate is found in relict blanket, deltaic, and channel deposits off the mouth of major rivers. One deposit of coarse sand and gravel within 10 miles of San Diego Bay in less than 65 feet of water has been surveyed and estimated to contain 26 million cubic yards of aggregate. Total resource estimates for the southern California region indicate about 40 billion cubic yards of sand and gravel.²⁹ However,

²⁹Williams, "Sand and Gravel Deposits Within the U.S. Exclusive Economic Zone," p. 382.

excessive amounts of overlying fine sand or mud, high wave energy, and unfavorable water depth may all reduce the economically recoverable material by as much as an order of magnitude. Individual deposits would need to be studied for their size, quality, and accessibility.

Sand and gravel resource estimates for northern California are based primarily on surface information with little or no data on depth and variability of the deposits. As is typical elsewhere, the sand and gravel deposits are both relict and recent. Much of the relict material appears to be too coarse to have been deposited by transport mechanisms operative at the present depth of the outer continental shelf.³⁰ These relict sands are thought to be near-shore bars and beach deposits formed during lower stands of sea level in the Pleistocene. Recent coarse material is nearer the coast and generally deposited parallel to the coastline by longshore currents. Sand and gravel estimates for the northern California shelf, assuming an average thickness of about 1 yard, are 84 million cubic yards of gravel, 542 million cubic yards of coarse sand, and 2.6 billion cubic yards of medium sand.³¹ Most of this material would lie in State waters.

Off the coast of Oregon and Washington, sea level fluctuations and glaciation controlled the location of coarse sand and gravel deposits. Most of the gravel lies to the north off Washington, where it was deposited in broad outwash fans by glacial meltwater streams when the sea level was about 650 feet lower than present. Promising gravel resource areas convenient to both Portland and Seattle are off Gray's Harbor, Washington, and the southern Olympic Mountains. Smaller gravel deposits off Oregon lie in swales between submarine banks in relict reworked beach deposits. Little data on the thickness of individual deposits are available, but general information on the thickness of outwash and beach sediments in the area suggest that estimates of 3 to 15 feet average thickness are reasonable.³²

³⁰S.G. Martindale and H.D. Hess, "Resource Assessment: Sand, Gravel, and Shell Deposits on the Continental Shelf of Northern and Central California," *Program Feasibility Document—OCS Hard Minerals Leasing*, app. 9, U.S. Department of the Interior, 1979, p. 5.

³¹*Id.*, p. 7.

³²G. W. Moore and M.D. Luken, "Offshore Sand and Gravel Resources of the Pacific Northwest," *Program Feasibility Document—OCS Hard Minerals Leasing*, app. 7, U.S. Department of the Interior, 1979, p. 8.

Precious Metals

Placer deposits containing precious metals have been found throughout the Pacific coastal region both offshore and along modern day beaches (figure 2-6). In the south, streams in the southern California borderland drain a coastal region of sandstone and mudstone marine sediments and granitic intrusive. These source rocks do not offer much hope of economically significant precious metal concentrations offshore, and fluvial placers have not been important in this area. North of Point Conception, gold placers have been worked and additional deposits might be found offshore.

The most promising region along the Pacific coast of the coterminous States is likely to be off northern California and southern Oregon where sediments from the Klamath Mountains are deposited. The Klamath Mountains are excellent source rocks containing, among other units, podiform ultramafic intrusive, which are thought to be the source of the platinum placers found in the region. Gold-bearing diorite intrusive are also present and provide economically interesting source rocks. Platinum and gold placers have both been mined from beaches in the region. In some areas, small flecks of gold appear in offshore surface sediments.

Several small gold and platinum beach placers have been mined on the coast of Washington from deposits which may have been supplied by glacially transported material from the north. The Olympic Mountains are not particularly noted for their ore mineralization, but gold and chromite-bearing rocks are found in the Cascades.

Two questions remain: do offshore deposits exist? and, if so, are they economic? For heavier minerals such as gold or platinum, only very fine-grained material is likely to be found offshore. Gold is not uncommon on Pacific beaches from northern California to Washington, but is often too fine-grained and too dispersed to be economically recovered at present. However, some experts also argue that in areas undergoing both uplift and cyclic glaciation and erosion, such as the shelf off southern Oregon, there may be several cycles of retrainment and progressive transport which could allow even the coarser grains of the precious metals to be transported some distance seaward on the shelf.³³

³³K. C. Bowman, "Evaluation of Heavy Mineral Concentrations on the Southern Oregon Continental Shelf," *Proceedings, Eighth Annual Conference, Marine Technology Society, 1972*, pp. 237-253.

Black Sand—Chromite Deposits

Chromite-rich black sands are found in relict beach deposits in uplifted marine terraces and in modern beach deposits along the coast of southern Oregon. The terrace deposits were actively mined for their chromium content during World War II. Remaining onshore deposits are not of current economic interest. However, there are indications that offshore deposits may be of future economic interest. Geologic factors in the development of placer deposits in relatively high-energy coastal regimes offer clues to chromite resource expectations in the EEZ.

Geologic Considerations

The ultimate source of chromite in the black sands found along the Oregon coast of Coos and Curry counties is the more or less serpentinized ultramafic rock in the Klamath Mountains. However much of the chromite in the beach deposits appears to have been reworked from Tertiary sedimentary rocks.³⁴ Chromite eroded out of the peridotites and serpentine of the Klamath Mountains was deposited in Tertiary sediments. Changes in sea level eroded these deposits and the chromite was released again and concentrated into deposits by wind, wave, and current action. These deposits have been uplifted and preserved in the present terraces and beach deposits.

This reworking through deposition, erosion, and redeposition is an important consideration in the formation of offshore placer deposits. Not only does reworking allow for the accumulation of more minerals of economic value over time, but it also allows the less resistant (and generally less valuable) heavy minerals such as pyroxenes and amphiboles to break down and thus not dilute or lower the grade of the deposit.

The river systems in the region were largely responsible for eroding and transporting the heavy minerals from the Klamath Mountains. Once in the marine environment, reworking of minerals was enhanced during periods of continental glaciation when the sea level fluctuated and the shoreline

³⁴A. B. Griggs, "Chromite-Bearing Sands of the Southern Part of the Coast of Oregon," *U.S. Geological Survey Bulletin, 945-E*, pp. 113-150.

retreated and advanced across the shelf at least four times. During these glacial periods, high rainfall, probable alpine glaciation in the higher Klamath peaks, and increased stream gradients from lowered base levels all contributed to accelerated erosion of the source area. Concentrations of heavy opaque minerals along the outer edge of the continental shelf off southern Oregon demonstrate the transport capacity of the pluvial-glacial streams during low stands of the sea.³⁵ High discharge and low stands of sea also allow for the formation of channel deposits on the shelf. During high interglacial stands of the sea, estuarine entrapment of sediments is a larger factor in the distribution of heavy minerals in the coastal environment. Each transgression and regression of the sea has the opportunity to rework relict or previously formed deposits. Preservation of these deposits is related to changes in the energy intensity of their environment.

While most geologists agree that uplifted beach terrace deposits and submerged offshore deposits are secondary sources of resistant heavy minerals in the formation of placer deposits, questions remain about which secondary source is more important. Differing views on the progressive enrichment of placer deposits have implications for locating concentrations of heavy minerals of economic value. One view is that each sea-level transgression reworks and concentrates on the shelf the heavy minerals laid down earlier, and any deposits produced during the more recent transgression are likely to be richer or more extensive than the raised terrace deposits that served as secondary sources since their emergence. This concentration effect would especially include those deposits now offshore which could be enriched by a winnowing process that removes the finer, lighter material, thereby concentrating the heavy minerals.³⁶ The other view is that offshore deposits are likely to be reworked as the sea level rises and heavy mineral concentrations in former beaches tend to move shoreward with the transgressing shore zone so that then the modern beaches would be richest in potentially economic heavy minerals. In this view, offshore deposits would be important secondary sources to the mod-

ern beaches, and raised terraces would be the next richest in heavy minerals.³⁷

Prospects for Future Development

The black sand deposits that were mined for chromite in the past offer a clue as to the nature of the deposits that might be found offshore. During World War II, approximately 450,000 tons of crude sand averaging about 10 percent chromite or 5 percent chromic oxide (Cr_2O_3) were produced. This yielded about 52,000 tons of concentrate at 37 to 39 percent Cr_2O_3 . The chromium to iron ratio of the concentrate was 1.6:1. A number of investigators have examined other onshore deposits. The upraised terraces near Bandon, Oregon, have been assessed for their chromite content with the aid of a drilling program. Over 2, 1 million tons of sand averaging 3 to 7 percent Cr_2O_3 is estimated for this 15-mile area.³⁸ Deposit thicknesses range from 1 to 20 feet, and associated minerals include magnetite, ilmenite, garnet, and zircon.

In a minerals availability appraisal of chromium, the U.S. Bureau of Mines assessed the southwest Oregon beach sands as having demonstrated resources (reserve base) of 11,935,000 short tons of mineralized material with a contained Cr_2O_3 content of 666,000 tons.³⁹ In the broader category of identified resources, the Oregon beach sands contain 50,454,000 tons of mineralized material with a Cr_2O_3 content of 2,815,000 tons. None of the beach sand material is ranked as reserves because it is not economically recoverable at current prices. If recovered, the demonstrated resources would amount to a little over one year's current domestic chromium consumption.

Another indication of the nature of potential Oregon offshore deposits comes from studies of coastal terrace placers, modern beach deposits, and offshore current patterns. In general, longshore currents tend to concentrate heavy minerals along the southern side of headlands. This concentration is

³⁷Emery and Noakes, "Economic Placer Deposits on the Continental Shelf," p. 107.

³⁸Bowman, "Evaluation of Heavy Mineral Concentrations on the Southern Oregon Continental Shelf," pp. 242-243.

³⁹J. F. Lemons, Jr., E. H. Boyle, Jr., and C. C. Kilgore, "Chromium Availability—Domestic, A Minerals Availability System Appraisal," *U.S. Bureau of Mines Information Circular*, IC 8895, 1982, p. 4.

³⁵*Ibid.*, p. 241.

³⁶Bowman, *Evaluation of Heavy Mineral Concentrations on the Southern Oregon Continental Shelf*, p. 243.

thought to be the result of differential seasonal longshore transport and shoreline orientation with regard to storm swell approach and zones of decelerating longshore currents. In addition, platform gradient also influences the distribution of placer sands, with steeper gradients increasing placer thickness. Similarly, the formation of offshore placer deposits would be determined by paleo-shoreline position and geometry, platform gradient, and paleo-current orientation.⁴⁰

Bathymetric data indicate several wave-cut benches left from former still stands of sea level. Concentrations of heavy minerals that may be related to submerged beach deposits have been found in water depths ranging from 60 to 490 feet. Surface samples of these deposits have black sand concentrations of 10 to 30 percent or more, and some are associated with magnetic anomalies indicating a likelihood of black sand placers within sediment thicknesses ranging from 3 to 115 feet. In addition, gold is found in surface sediments in some of these areas. These submerged features would be likely prospects for high concentrations of chromite and possibly for associated gold or platinum.

Several Oregon offshore areas containing concentrations of chromite-bearing black sands in the surface sediment have been mapped. These areas range from less than 1 square mile to over 80 square miles in areal extent, and they are found from Cape Ferrelo north to the Coquille River, with the largest area nearly 25 miles long, centered along the coast off the Rogue River. If metal tenor (content) increases with depth, as some investigators expect, there may be considerable potential for economically interesting deposits offshore. Also depending on the value of any associated heavy minerals, chromite might be recovered either as the primary product or as the byproduct of other minerals extraction.

Other Heavy Minerals

North of Point Conception in California, a few small ultramafic bodies are found within coastal drainage basins. Heavy mineral fractions in beach and stream sediments are relatively high in titanium

⁴⁰C. D. Peterson, G. W. Gleeson, and N. Wetzel, "Stratigraphic Development, Mineral Sources, and Preservation of Marine Placers from Pleistocene Terraces in Southern Oregon, USA," *Sedimentary Geology*, in press.

minerals associated with monazite and zircon, and small quantities of chromite have been found. Titanium minerals have been mined from beach sands in this area in the past.

The Klamath Mountains of southwestern Oregon and northwestern California contain a complex of sedimentary, metasedimentary, metavolcanic, granitoid, and serpentinized ultramafic rocks that are the source of most, if not all, of the heavy minerals and free metals found on the continental shelf in that region. In addition to metallic gold, platinum metals, and chromite discussed previously, these minerals include ilmenite, magnetite, garnet, and zircon. Abrasion during erosion and transport of these minerals is minimal, and they are generally resistant to chemical weathering.

Another area of interest for heavy mineral placer deposits is off the mouth of the Columbia River. The Columbia River drains a large and geologically diverse region and its sediments dominate the coastal areas of northern Oregon and southern Washington. A large concentration of titanium-rich black sand has been reported on the shelf south of the Columbia River.⁴¹ Sand from this deposit has been found to average about 5 percent ilmenite and 10 to 15 percent magnetite. Several other smaller areas on the Oregon shelf containing high heavy mineral concentrations lie seaward of or adjacent to river systems. Estimates of heavy mineral content on the Oregon shelf suggest a potential of several million tons each of ilmenite, rutile, and zircon.⁴²

Chromite, ilmenite, and magnetite are also found in heavy mineral placers on the Washington coast. Five areas on the Washington shelf contain anomalously high concentrations of heavy minerals. Three areas south of the Hoh River and off Gray's Harbor are at depths of 60 to 170 feet and probably represent beach deposits formed during low stands of the sea. Two more areas are near the mouth of the Columbia River.

⁴¹R. L. Phillips, "Heavy Minerals and Bedrock Minerals on the Continental Shelf off Washington, Oregon, and California," *Program Feasibility Document—OCS Hard Minerals Leasing*, app. B, U.S. Department of the Interior, 1979, pp. 14-17.

⁴²Beauchamp and Cruickshank, "Placer Minerals on the U.S. Continental Shelves—Opportunity for Development, p. 700.

Phosphorite Deposits

The southern portion of the California borderland is well known for marine phosphorite deposits. The deposits are located on the tops of the numerous banks in areas relatively free of sediment. The phosphorites are Miocene in age and are generally found in water depths between 100 and 1,300 feet. The deposits consist of sand, pebbles, biological remains, and phosphorite nodules. Relatively rich surficial nodule deposits averaging 27 percent P_2O_5 are found on the Coronado, Thirty Mile and Forty Mile banks, and west of San Diego. Estimates based on available data on grade and extent of the major deposits known in the region indicate a resource base of approximately 72 million tons of phosphate nodules and 57 million tons of phosphatic sands.⁴³ However, because assumptions were necessary to derive these tonnages, these estimates should be regarded as being within only an order of magnitude of the actual resource potential of the area. Further sampling and related investigations are necessary to define the resource base more accurately.

Phosphorite deposits are also found further north off central California at water depths of 3,300 to 4,600 feet. These deposits, located off Pescadero Point, on Sur Knoll and Twin Knolls, range in P_2O_5 content from 11.5 to 31 percent, with an average content of 24 percent.⁴⁴ However, their patchy distribution and occurrence at relatively great water depths make them economically less attractive than the deposits off the southern California shore.

Polymetallic Sulfide Deposits

“*Polymetallic sulfide*” is a popular term used to describe the suites of intimately associated sulfide minerals that have been found in geologically active areas of the ocean floor. The relatively recent discovery of the seabed sulfide deposits was not an accident. The discovery confirmed years of research and suggestions regarding geological and geochemical processes at the ocean ridges. Research related

⁴³H. D. Hess, “Preliminary Resource Assessment—Phosphorites of the Southern California Borderland, *Program Feasibility Document—OCS Hard Minerals Leasing*, app. 11, U.S. Department of the Interior, 1978, p. 21.

⁴⁴H. T. Mullins and R. F. Rasch, “Sea-Floor Phosphorites along the Central California Continental Margin, *Economic Geology*, vol. 80, 1985, pp. 696-715.

to: 1) separation of oceanic plates, 2) magma upwelling at the ocean ridges, 3) chemical evolution of seawater, and 4) land-based ore deposits that were once submarine, has contributed to and culminated in hypotheses of seawater circulation and mineral deposition at ocean spreading centers that closely fit recent observations. Much of the current interest in the marine polymetallic sulfides stems from the dynamic nature of the processes of formation and their role in hypotheses of the evolution of the Earth’s crust. An understanding of the conditions resulting in the formation of these marine sulfides allows geologists to better predict the occurrence of other marine deposits and to better understand the processes that formed similar terrestrial deposits.

Geologic Considerations

The Gorda Ridge and possibly part of the Juan de Fuca Ridge (pending unsettled boundary claims) are within the EEZ of the United States. They are part of the seafloor spreading ridge system that extends over 40,000 miles through the world’s oceans. These spreading centers are areas where molten rock (less dense than the solid, cold ocean crust) rises to the seafloor from depth, as the plates move apart. Plates move apart from one another at different rates, ranging from 1 to 6 inches per year. Limited evidence suggests that the relative rate of spreading has an influence on the type, distribution, and nature of the hydrothermal deposits formed, and that significant differences can be expected between slow-spreading centers and intermediate- to fast-spreading centers.⁴⁵

The mineralization process involves the interaction of ocean water with hot oceanic crust. Simply stated, ocean water percolates downward through fractures in the solid ocean crust. Heated at depth, the water interacts with the rock, leaching metals. Key to the creation of an ore deposit, the metals become more concentrated in the percolating water than they are in the surrounding rocks. The hot (300 to 400° centigrade) metal-laden brine moves upward and mixes with the cold ocean water, causing the metals to precipitate, forming sulfide min-

⁴⁵P. A. Rona, “Hydrothermal Mineralization at Slow-Spreading Centers: Red Sea, Atlantic Ocean, and Indian Ocean, *Marine Mining*, vol. 5, No. 2, 1985, pp. 117-145.

Figure 2-7.—Formation of Marine Polymetallic Sulfide Deposits

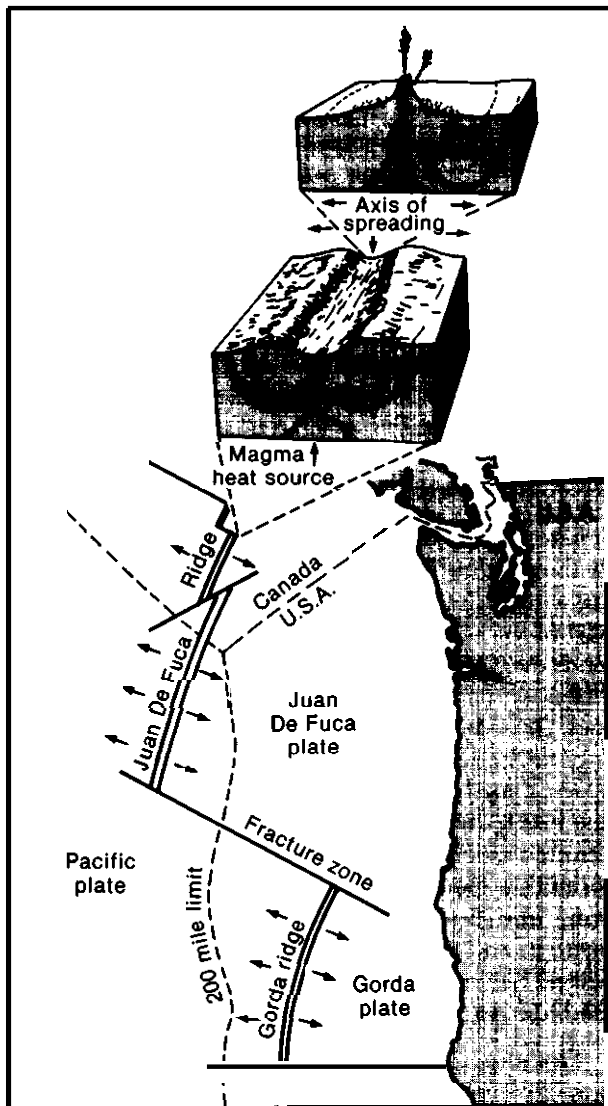

The Juan de Fuca and Gorda Ridges are active spreading centers off the coasts of Washington, Oregon, and California. Polymetallic sulfides are formed at spreading centers, where seawater heated by magma circulates through the rocks of the seafloor dissolving many minerals and depositing massive sulfide bodies containing zinc, copper, iron, lead, cadmium, and silver. Such sulfide deposits have been found on the Juan de Fuca Ridge within the EEZ of Canada and on the Gorda Ridge within the U.S. EEZ.

SOURCES: Office of Technology Assessment, 1987; M.A. Champ, W.P. Dillon, and D.G. Howell, "Non-Living EEZ Resources: Minerals, Oil, and Gas," *Oceanus*, volume 27, number 4, winter 1984/85.

erals along cracks, crusts on the oceanfloor, or chimneys or stacks (figure 2-7). High temperatures suggest little or no mixing with cold seawater before the solutions exit through the vents.

The degree to which the ore solution is diluted in the subsurface depends on the porosity or fracturing of the near surface rock and also determines the final exit temperature and composition of the hydrothermal fluids. The fluid ranges from manganese-rich in extreme dilution to iron-dominated at intermediate dilution levels to sulfide deposition when little dilution occurs. In support of these observations, investigators have found sulfide deposition at the vents with manganese oxide deposits farther away from the seawater-hydrothermal fluid interface.⁴⁶ Iron oxides are often found in association with, but at a distance from, the active vent and sulfide mineralization.

An important control on the location of hydrothermal mineralization, either beneath or on the seafloor at a spreading center, is whether the subsurface hydrothermal convection system is leaky or tight. In leaky high-intensity hydrothermal systems, seawater penetrates downward through fractures in the crust and mixes with upwelling primary hydrothermal solutions, causing precipitation of disseminated, stockwork, and possibly massive copper-iron-zinc sulfides beneath the seafloor. Dilute, low-temperature solutions depleted in metals discharge through vents to precipitate stratiform iron and manganese oxides, hydroxide, and silicate deposits on the seafloor and suspended particulate matter enriched in iron and manganese in the water column.⁴⁷ In tight, high-intensity hydrothermal systems, primary hydrothermal solutions undergo negligible mixing with normal seawater beneath the seafloor and discharge through vents to precipitate massive copper-iron-zinc sulfide deposits on the seafloor and suspended particulate matter enriched in various metals in the water column.

⁴⁶East Pacific Rise Study Group, "Crustal Processes of the Mid-Ocean Ridge," *Science*, vol. 213, July 3, 1981, pp. 31-40.

⁴⁷Rena, "Hydrothermal Mineralization at Slow-Spreading Centers: Red Sea, Atlantic Ocean, and Indian Ocean," p. 123.

Table 2-5.—Estimates of Typical Grades of Contained Metals for Seafloor Massive Sulfide Deposits, Compared With Typical Ore From Ophiolite Massive Sulfide Deposits and Deep-Sea Manganese Nodules

Element	Sulfides, lat 21° N. & Juan de Fuca Ridge	Sulfides Galapagos rift	Sulfide ore, Cyprus	Deep-sea manganese nodules
	Typical grade, in percent	Typical grade, in percent	Typical grade, in percent	Typical grade, in percent
Zinc	30	0.2	0.2	0.13
Copper	0.5	5.0	2.5	0.99
Nickel	—	—	—	1.22
Cobalt	—	0.02	—	0.23
Molybdenum	—	0.017	—	0.018
Silver	0.02	—	—	—
Lead	0.30	—	—	—
Manganese	—	—	—	28.8
Germanium	0.01	—	—	.

SOURCE: Adapted from V. E. McKelvey, "Subsea Mineral Resources," U.S. Geological Survey, Bulletin, 1669-A, 1966, p. 62

Prospects for Future Development

At the present time, too little is known about marine polymetallic sulfide deposits to project their economic significance. Analysis of grab samples of sulfides collected from several other spreading zones indicate variable metal values, particularly from one zone to another. In general, all of the deposits sampled, except those on the Galapagos rift, have zinc as their main metal in the form of sphalerite and wurtzite. The Galapagos deposits differ in that they contain less than 1 percent zinc but have copper contents of 5 to 10 percent, mainly in the form of chalcopyrite. Weight percentage ranges of some metals found in the sulfide deposits are given in table 2-5. Some of the higher analyses are from individual grab samples composed almost entirely of one or two metal sulfide minerals and analyze much higher in those metal values (e. g., a Juan de Fuca Ridge sample which is 50 percent zinc is primarily zinc sulfide). While this is impressive, it says nothing about the extent of the deposit or its uniformity. In any event, it is certain that any future mining of hydrothermal deposits would recover a number of metal coproducts.

Highly speculative figures assigning tonnages and dollar values to ocean polymetallic sulfide occurrences have begun to appear. Observers should be extremely cautious in evaluating data related to these deposits. The deposits have only been examined from a scientific perspective related primarily to the process of hydrothermal circulation and its chemical and biological influence on the ocean.

No detailed economic evaluations of these deposits or of potential recovery techniques have been made. Thus, estimates of the extent and volume of the deposits are based on geologic hypotheses and limited observational information. Even estimates of the frequency of occurrence of submarine sulfide deposits would be difficult to make at present. Less than 1 percent of the oceanic ridge system has been explored in any detail.

A further note of caution is also in order. In describing the potential for polymetallic sulfide deposits, several investigators have drawn parallels or made comparisons to the costs of recovery and environmental impacts of ferromanganese nodule mining. There is also a parallel with regard to economic speculation. Early speculative estimates of the tonnages of ferromanganese nodules in the Pacific Ocean were given by John Mero in 1965 as 1.5 trillion tons.⁴⁸ Even though this estimate was subsequently expressed with caveats as to what might be potentially mineable (10 to 500 billion tons),⁴⁹ the estimate of 1.5 trillion tons was widely quoted and popularized, thus engendering a common belief at the time that the deep seabed nodules were a virtually limitless untapped resource—a wealth that could be developed to preferential benefit of less developed nations. The unlimited abun-

⁴⁸Mero, *Th. Mineral Resources of the Sea*, p.175.

⁴⁹J. L. Mere, "Potential Economic Value of Ocean-Floor Manganese Nodule Deposits," *Ferromanganese Deposits on the Ocean Floor*, D.R. Horn (ed.), National Science Foundation, International Decade of Ocean Exploration, Washington, DC, 1972, p. 202.



Photo credit: U.S. Geological Survey

Hand sample of sulfide minerals recovered from Juan de Fuca Ridge.

red

Bac m a p ad g M
 ade w pwa g p m
 m e m ad
 p m a ba w 98 m ea m
 C m d pa d m ea em
 d w m g d
 g pp
 d adm m d

dance of seabed nodules was a basic premise on which the Third United Nations Conference on the Law of the Sea was founded. Economic change and subsequent research indicate both a more limited mineable resource base and much lower projected rates of return from nodule mining. However, as often happens, positions that become established on the basis of one set of assumptions are difficult to amend when the assumptions change.

Creating expectations on the basis of highly speculative estimates of recoverable tonnages and values for hypothetical metal deposits serves little

purpose. Avoiding the present temptation to extrapolate into enormous dollar values could avoid what may, upon further research, prove to be less than a spectacular economic resource in terms of recovery. This is not to say that the resource may not be found, but simply that it is premature to define its extent and estimate its economic value.

What then can be said about expectations for the U.S. EEZ? The Gorda Ridge is a relatively slow spreading active ridge crest. Until recently, most sulfide deposits were found on the intermediate- to fast-spreading centers (greater than 2 inches per year). This trend led some investigators to consider the potential for sulfide mineralization at slow-spreading centers to be lower than at faster spreading centers. On the other hand, the convective heat transfer by hydrothermal circulation is on the same order of magnitude for both types of ridges. This

suggests that, if crustal material remains close to hydrothermal heat sources for a longer period of time, it might become even more greatly enriched through hydrothermal mineralization.⁵⁰ In any event, a complete series of hydrothermal phases can be expected at slow-spreading centers, ranging from high-temperature sulfides to low-temperature oxides. The hydrothermal mineral phases include massive, disseminated and stockwork sulfide deposits and stratiform oxides, hydroxides, and silicates,

To account further for their differences, the deeper seated heat sources at slow-spreading centers can be inferred to favor development of leaky hydrothermal systems leading to precipitation of the sulfides beneath the seafloor. This inference, however, cannot be verified until the deposits are drilled extensively.

Another view regarding the differences in potential for mineralization between fast- versus slow-spreading ridge systems suggests that the extent of hydrothermal activity and polymetallic sulfide deposition along oceanic ridge systems is more a function of that particular segment's episodic magmatic phase than the spreading rate of the ridge as a whole.⁵¹ According to this view, at any given time a ridge segment with a medium or slow average spreading rate may show active hydrothermal venting as extensive as that found along segments with fast spreading rates. Thus, massive polymetallic sulfide deposits may be present along slow-spreading ridge segments, but they probably would be separated by greater time and distance intervals.

Another factor, particularly on the Gorda Ridge, is the amount of sediment cover. The 90-mile-long,

sediment-filled Escanaba Trough at the southern part of the Gorda Ridge is similar to the Guaymas Basin in the Gulf of California, where hydrothermal sulfide mineralization has been found. The amount of sediment entering an active spreading center is critical to the formation and preservation of the sulfide deposits. Too much material delivered during mineralization will dilute the sulfide and reduce the economic value of the deposit. On the other hand, an insufficient sediment flux can result in eventual oxidation and degradation of the unprotected deposit.

Sulfide deposits and active hydrothermal discharge zones have been found on the southern Juan de Fuca Ridge beyond the 200-nautical-mile limit of the EEZ. The Juan de Fuca Ridge is a medium-rate spreading axis separating at the rate of 3 inches per year. Zinc and silver-rich sulfides have been dredged from two vent sites that lie less than a mile apart. Photographic information combined with geologic inference suggests a crude first-order estimate of 500,000 tons of zinc and silver sulfides in a 4-mile-long segment of the axial valley.⁵²

Although marine polymetallic sulfide deposits may someday prove to be a potential resource in their own right, the current value of oceanfloor sulfides lies in the scientific understanding of their formation processes as well as their assistance in the possible discovery of analogous deposits on land (figure 2-8). Cyprus; Kidd Creek, Canada; and the Kuroko District in Japan are all mining sites for polymetallic sulfides, and all of these areas show the presence of underlying oceanic crust. The key to the past by studying the present is unraveling the mechanisms by which this very important class of minerals and ores were formed.

⁵⁰Rena, "Hydrothermal Mineralization at Slow-Spreading Centers: Red Sea, Atlantic Ocean and Indian Ocean," p. 140.

⁵¹A. Malahoff, "Polymetallic Sulfides—A Renewable Marine Resource," *Marine Mining: A New Beginning, Conference Proceedings, July 18-21, 1982*, Hilo, HI, State of Hawaii, sponsored by Department of Planning and Economic Development, 1985, pp. 31-60.

⁵²R. A. Koski, w. R. Normark, and J. L. Morton, "Massive Sulfide Deposits on the Southern Juan de Fuca Ridge: Results of Investigations in the USGS Study Area, 1980-83," *Marine Mining*, vol. 4, No. 2, 1985, pp. 147-164.

ALASKA REGION

In southeastern Alaska, the coast is mountainous and heavily glaciated. Glacial sediments cover much of the shelf, which averages about 30 miles in width. The Gulf of Alaska has a wide shelf that

was mostly covered by glaciers during the Pleistocene. The eastern coast of the Gulf is less mountainous and lower than the steep western coast. The source rocks in the region include a wide range of

Figure 2-8.—Locations of Mineral Deposits Relative to Physiographic Features (vertical scale exaggerated)

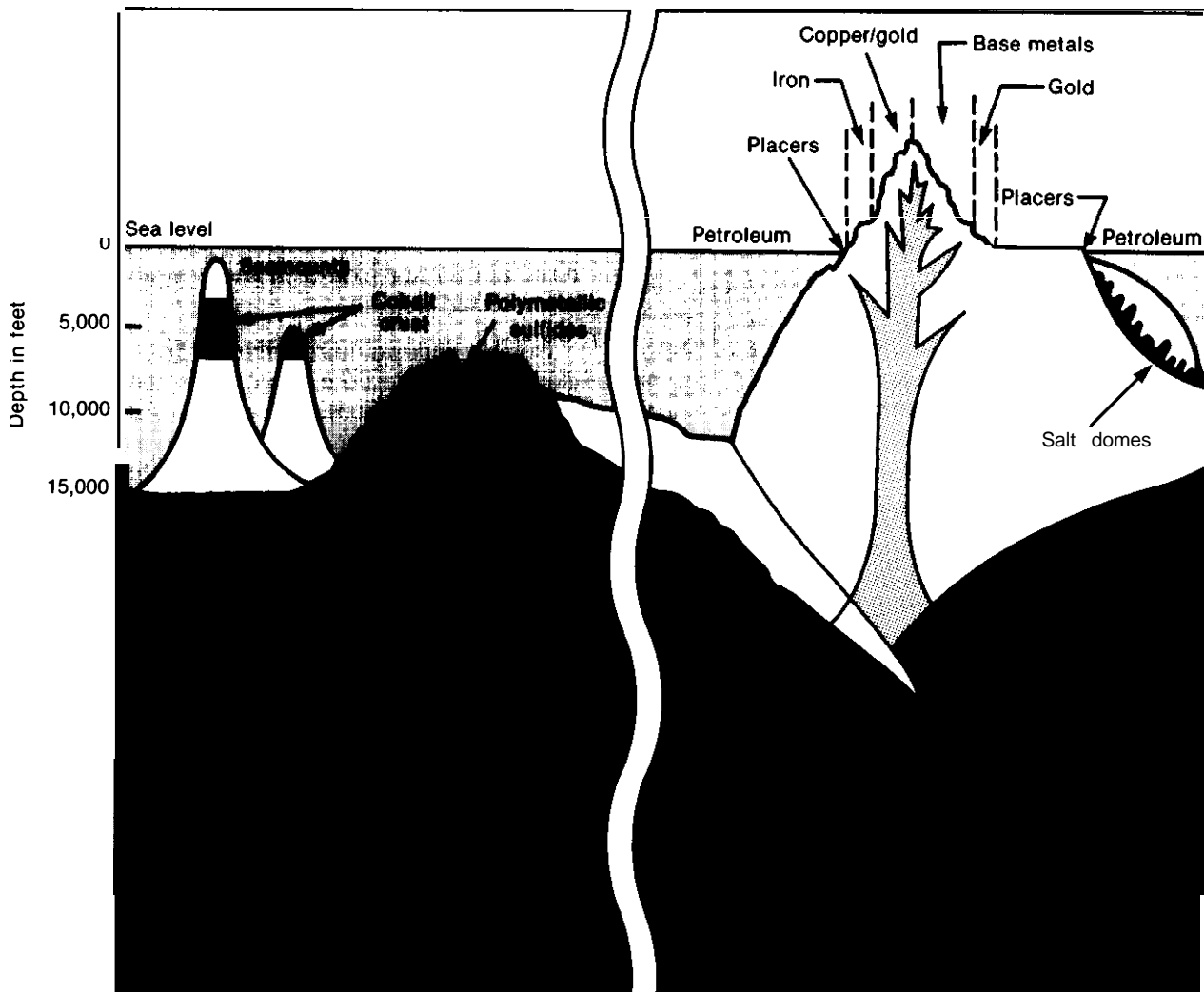

SOURCES: Office of Technology Assessment, 1987; Bonnie A. McGregor and Millington Lockwood, "Mapping and Research In the Exclusive Economic Zone," Department of the Interior, U.S. Geological Survey and Department of Commerce, National Oceanic and Atmospheric Administration.

sedimentary, metamorphic, volcanic, and intrusive bodies.

The Alaska Peninsula and Aleutian Islands consist of intrusive and volcanic rocks related to the subduction zone along the Pacific side. The shelf narrows westward from a width of nearly 125 miles to places where it is nearly nonexistent between the Aleutian Islands. The Aleutians are primarily andesitic volcanics while granitic intrusive are found on the peninsula.

The Bering Sea shelf is very broad and generally featureless except for a few islands, banks, and depressions. A variety of sedimentary, igneous, and metamorphic rocks are found in the region. In the south, of particular mineralogical interest, are the Kuskokwim Mountains containing Precambrian schist and gneiss, younger intrusive rocks, and dunite. The Yukon River is the dominant drainage system entering the Bering shelf, although several major rivers contribute sediments including streams on the Asian side. The region also has been

significantly affected by glaciation and major sea level changes. Glacial sediment was derived from Siberia as well as Alaska. Barrier islands are found along the northern side of the Seward Peninsula.

The major physiographic feature of the north coast of Alaska is the gently sloping arctic coastal plain, which extends seaward to form a broad shelf under the Chukchi and Beaufort Seas. This area was not glaciated during the Pleistocene, and only one major river, the Colville, drains most of the region into the Beaufort Sea. The drainage area includes the Paleozoic sedimentary rocks of the Brooks Range and their associated local granitic intrusive and metamorphosed rocks.

Sand and Gravel

Approximately 74 percent of the continental shelf area of the United States is off the coast of Alaska. Consequently, Alaskan offshore sand and gravel resources are very large. However, since these materials are not generally located near centers of consumption, mining may not always be economically viable.

While glaciation has deposited large amounts of sand and gravel on Alaska's continental shelf, the recovery of economic amounts for construction aggregate is complicated by two factors:

1. much of the glacial debris is not well sorted, and
2. it is often buried under finer silt and mud washed out after deglaciation.

Optimal areas for commercial sand and gravel deposits would include outwash plains or submerged moraines that have not been covered with recent sediment, or where waves and currents have winnowed out finer material.

In general, much of the shelf of southeastern Alaska has a medium or coarse sand cover and is not presently receiving depositional cover of fine material. The Gulf of Alaska is currently receiving glacial outwash of fine sediment in the eastern part and, in addition, contains extensive relict deposits of sand and gravel. Economic deposits of sand have been identified parallel to the shoreline west of Yakutat and west of Kayak Island. An extensive area of sand has been mapped in the lower

Cook Inlet, and gravel deposits are also present there (figure 2-9). Large quantities of sand and gravel are also found on the shelf of Kodiak Island. The Aleutian Islands are an unfavorable area for extensive sand and gravel deposits. Relict glacial sediments should be present on the narrow shelf, but the area is currently receiving little sediment.

Large amounts of fine sand lie in the southern Bering Sea and off the Yukon River, but the northern areas may offer the greatest resource potential for construction aggregate. Extensive well-sorted sands and gravels are found at Cape Prince of Wales and northwest of the Seward Peninsula. However, distances to Alaskan market areas are considerable. Sand, silt, and mud are common on the shelf in the Chukchi Sea and Beaufort Sea. Small, thin patches of gravel are also present, but available data are sparse. The best prospect of gravel in the Beaufort Sea is a thick layer of Pleistocene gravel buried beneath 10 to 30 feet of overburden east of the Colville River.

Overall sand and gravel resource estimates of greater than 200 billion cubic yards are projected for Alaska (table 2-4). In many areas, environmental concerns in addition to economic considerations would significantly influence development.

Precious Metals

Source rocks for sediments in southeastern Alaska are varied. Gold is found in the region and has been mined from placer deposits. Platinum has been mined from lode deposits on Prince of Wales Island. Although few beach or marine placer deposits are found in the area, the potential exists since favorable source rocks are present. However, glaciation has redistributed much of the sediment, and the shelf is receiving relatively little modern sediment.

Some gold has been recovered from beach placers in the eastern Gulf of Alaska; but, in general, the prospects for locating economic placers offshore would not be great because of the large amount of glacially derived fine-grained material entering the area. In the western Gulf, the glaciation has removed much of the sediment from the coastal area and deposited it offshore where subsequent reworking may have formed economically interesting

Figure 2-9.—Potential Hard Mineral Resources of the Alaskan EEZ

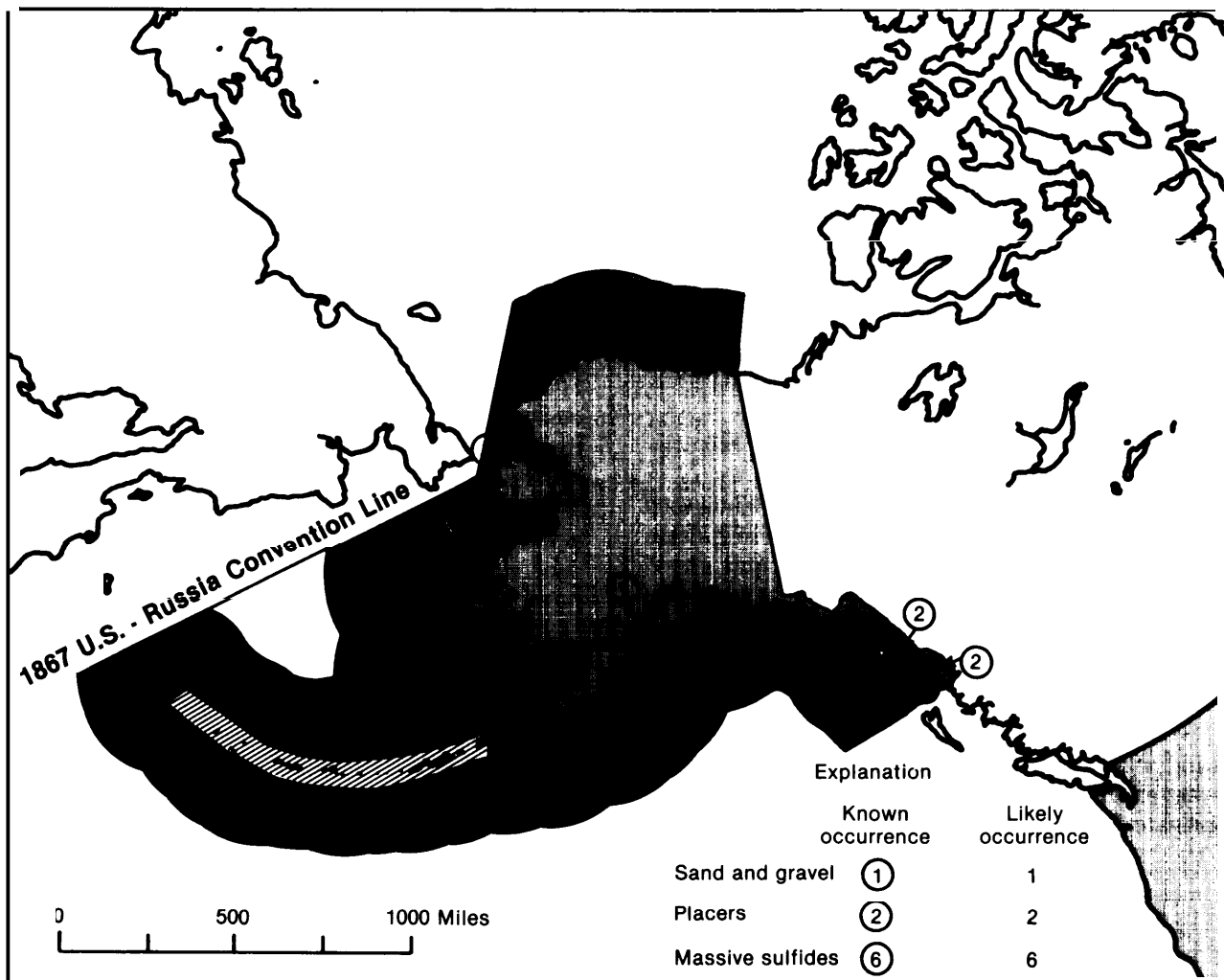

Gold and gravel have been mined from Alaskan waters and the potential exists for locating other offshore placer deposits.

SOURCES: Off Ice of Technology Assessment, 1987; U.S. Department of the Interior, "Symposium Proceedings-A National Program for the Assessment and Development of the Mineral Resources of the United States Exclusive Economic Zone," U.S. Geological Survey Circular 929, 1983.

placer deposits.⁵³ Gold is found in the region and has been mined from beaches on Kodiak Island and Cook Inlet. Placer deposits may have formed on the outer shelf but recovery may be difficult. Lower Cook Inlet might be the best area of the Gulf to prospect.

⁵³H. E. Clifton and G. Luepke, *Heavy-Mineral Placer Deposits of the Continece Margin of Alaska and the Pacific Coast States*, in *Geology and Resource Potential of the Continental Margin of Western North America and Adjacent Ocean Basin-Beaufort Sea to Baja, California*, American Association of Petroleum Geologists Memoir, ed., D.W. Scholl, (in press).

The shelf along the Aleutian Islands is a relatively unfavorable prospective locale for finding economic placer deposits. Sediment supply is limited, and ore mineralization in the volcanic source rocks is rare. Lode and placer gold deposits have been found on the Alaska Peninsula, and gold placers may be found off the south shore near former mining areas.

Platinum has been mined from alluvial placers near Goodnews Bay on the Bering Sea. Anomalous concentrations of platinum are also found on

the coast south of the Salmon River and in sediments in Chagvan Bay.⁵⁴ The possibility exists that platinum placers may be found on the shelf if glacially transported material has been concentrated by marine processes. Source rocks are thought to be dunites in the coastal Kuskokwim Mountains, but lode deposits have not been found. Gold placers are also found along the coast of the Bering Sea and are especially important to the north near Nome. Lode gold and alluvial placers are common along the southern side of the Seward Peninsula, and tin placers have also been worked in the area. Gold has been found offshore in gravel on submerged beach ridges and dispersed in marine sands and muds. Economic deposits may be found in the submerged beach ridges or in buried channels offshore. The region around Nome has yielded about 5 million ounces of gold, mainly from beach deposits, and it is suggested that even larger amounts may lie offshore.⁵⁵ How much of this, if any, may be discovered in economically accessible deposits is uncertain, but the prospects are probably pretty good in the Nome area.

⁵⁴R. M. Owen, "Geochemistry of Platinum-Enriched Sediments: Applications to Mineral Exploration," *Marine Mining*, vol. 1, No. 4, 1978, pp. 259-282.

⁵⁵Beauchamp and Cruickshank, "Placer Minerals on the U.S. Continental Shelves—Opportunity for Development," p. 700.

HAWAII REGION AND U.S. TRUST TERRITORIES

Hawaii is a tectonically active, mid-ocean volcanic chain with typically narrow and limited shelf areas. Sand and gravel resources are in short supply. The narrow shelf areas in general do not promote large accumulations of sand and gravel offshore. One area of interest is the Penguin Bank, which is a drowned shore terrace about 30 miles southeast of Honolulu (figure 2-10). The bank's resource potential is conservatively estimated at over 350 million cubic yards of calcareous sands in about 180 to 2,000 feet of water.⁵⁶ This resource could supply Hawaii's long-term needs for beach restoration and, to a lesser extent for construction. However, high winds and strong currents are common

⁵⁶W. B. Murdaugh, "Preliminary Feasibility Assessment: Offshore Sand Mining, Penguin Bank, Hawaii," *Program Feasibility Document—OCS Hard Minerals Leasing*, app. 19, U.S. Department of the Interior, 1979, p. 14.

Other Heavy Minerals

The eastern Gulf of Alaska is strongly influenced by the modern glaciers in the area. Fresh, glacially derived sediments, including large amounts of fine-grained material, are entering the area and being sorted by marine processes. Heavy mineral suites are likely to be fairly immature and burial is rapid. In general, the prospects for locating economically interesting heavy mineral placers offshore in this area would not be great.

About 2,000 tons of tin have been produced from placers on the western part of the Seward Peninsula. Tin in association with gold and other heavy minerals may occur in a prominent shoal which extends over 22 miles north-northeast from Cape Prince of Wales along the northwest portion of the Seward Peninsula. While seafloor deposits off the Seward Peninsula might be expected to contain gold, cassiterite, and possibly tungsten minerals, data are lacking to evaluate the resource potential.

In general, the Chukchi and Beaufort seas may not contain many economic placers. Source rocks are distant, and ice gouging tends to keep bottom sediments mixed.

on the Penguin Bank. Total sand and gravel resource estimates for Hawaii may be as high as 25 billion cubic yards (table 2-4).

No metalliferous deposits are mined onshore in Hawaii. Thus the prospects are somewhat poor for locating economically attractive placer deposits on the Hawaiian outer continental shelf. Minor phosphorite deposits have been found in the Hawaii area, although phosphorite is found on seamounts elsewhere in the Pacific.

The geology of the U.S. Trust Territories is generally similar to Hawaii with the islands being of volcanic origin, often supporting reefs or limestone deposits. Clastic debris of the same material is present and concentrated locally, but very little information is available as to the nature and extent of any sand or gravel deposits. Other areas are rela-

Figure 2-10.—Potential Hard Mineral Resources of the Hawaiian EEZ

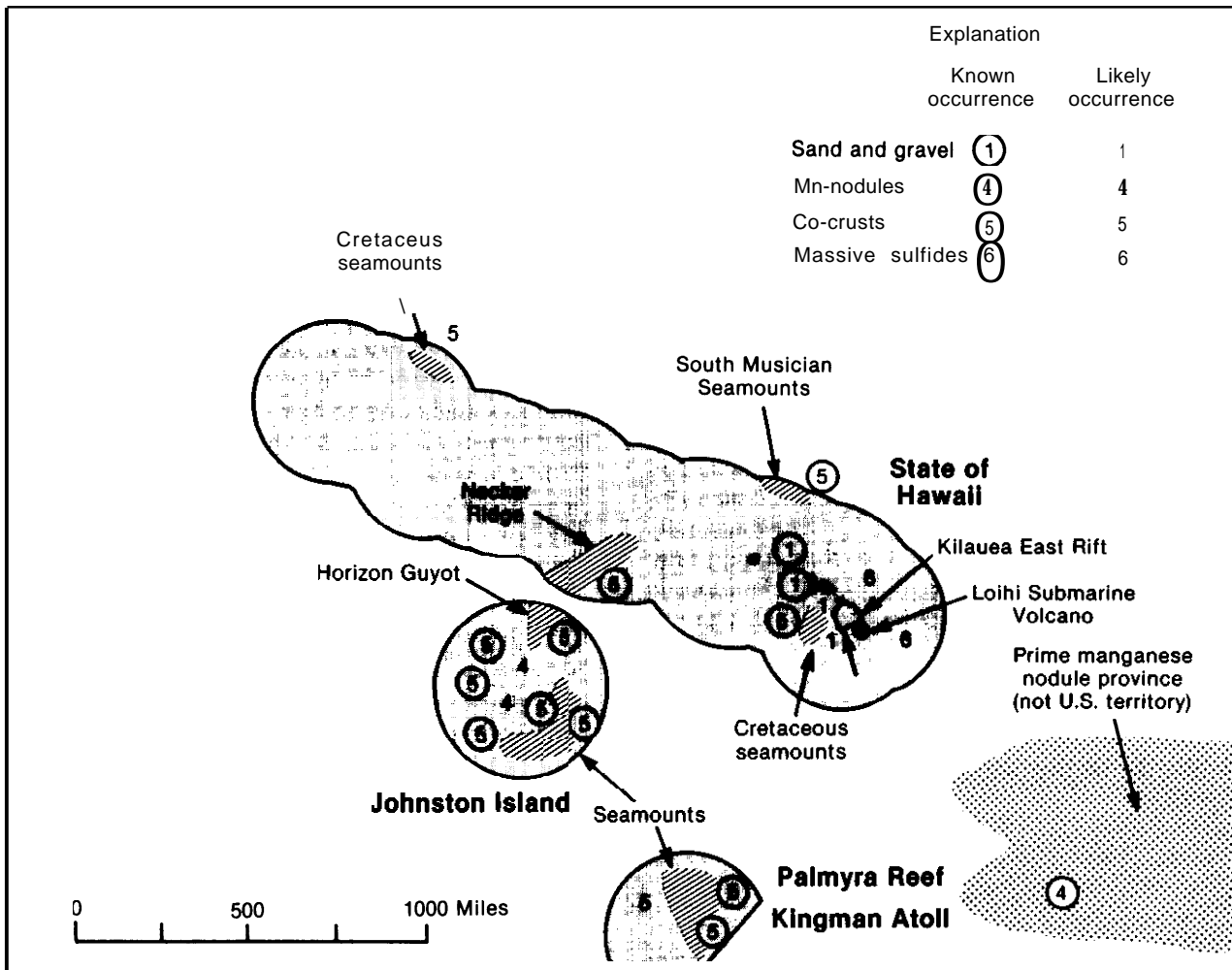

SOURCES: Office of Technology Assessment, 1987; U.S. Department of the Interior, "Symposium Proceedings—A National Program for the Assessment and Development of the Mineral Resources of the United States Exclusive Economic Zone," U.S. Geological Survey Circular 929, 1983.

tively free of sediment or are covered with fine sediment consisting of red clay and/or calcareous ooze. The extent to which the United States has jurisdiction over the EEZs of the various Trust Territories (figure 2-11) is examined in appendix B.

Cobalt-Ferromanganese Crusts

Recently, high concentrations of cobalt have been found in ferromanganese crusts, nodules, and slabs on the sides of several seamounts, ridges, and other raised areas of ocean floor in the EEZ of the central Pacific region. The current interest in cobalt-enriched crusts follows an earlier period of consid-

erable activity during the 1960s and 1970s to determine the feasibility of mining manganese nodules from the deep ocean floor. While commercial prospects for deep seabed nodule mining have receded because of unfavorable economics compounded by political uncertainties resulting from the Law of the Sea Convention, commercial interest in cobalt-ferromanganese crusts is emerging. A number of factors are contributing to this shift of interest, including seamount crusts that:

1. appear to be richer in metal content and more widely distributed than previously recognized,
2. are at half the depth or less than their abyssal counterparts,

Figure 2-11.—Cobalt-Rich Ferromanganese Crusts on the Flanks of Seamounts and Volcanic Islands

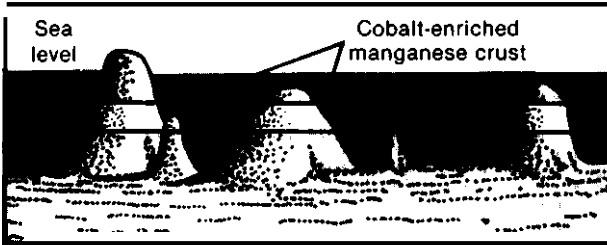

Iron-manganese crusts enriched in cobalt occur on the flanks of volcanic islands and seamounts in geochemically favorable areas of the Pacific. Samples have been recovered for scientific purposes, but equipment for potential commercial evaluation and recovery has not been developed.

SOURCES: Office of Technology Assessment, 1987; Bonnie A. McGregor and Terry W. Of field, "The Exclusive Economic Zone: An Exciting New Frontier," U.S. Department of the Interior, Geological Survey.

3. can be found within the U.S. EEZ which could provide a more stable investment climate, and
4. may provide alternative sources of strategic metals.

Geologic Considerations

Ferromanganese crusts range from thin coatings to thick pavements (up to 4 inches) on rock surfaces that have remained free of sediment for millions of years. The deposits are believed to form by precipitation of hydrated metal oxides from near-bottom seawater. The crusts form on submarine volcanic and phosphorite rock surfaces or as nodules around nuclei of rock or crust fragments. They differ from deep ocean nodules, which form on the sediment surface and derive much of their metals from the interstitial water of the underlying sediment. Several factors appear to influence the composition, distribution, thickness, and growth rate of the crusts. These factors include metal concentration in the seawater, age and type of the substrate, bottom currents, depth of formation, latitude, presence of coral atolls, development of an oxygen-minimum zone, proximity to continents, and geologic setting.

The cobalt content varies with depth, with maximum concentrations occurring between 3,300 and 8,200 feet in the Pacific Ocean. Cobalt concentrations greater than 1 percent are generally restricted to these depths. Platinum (up to 1.3 parts per mil-



P w w g m R g
 w m g mm m
 w m m m
 m m m

lion) and nickel (to 1 percent) are also found associated with cobalt in significant concentrations in many ferromanganese crust areas. Other metals found in lesser but significant amounts include lead, cerium, molybdenum, titanium, rhodium, zinc, and vanadium (table 2-6).

At least two periods of crust formation occur in some crusts. Radiometric dating and other analyses indicate that crusts have been forming for the last 20 million years, with one major interruption in ferromanganese oxide accretion during the late Miocene, from 8 to 9 million years ago, as detected in some samples. During this period of interruption, phosphorite was deposited, separating the older and younger crust materials. In some areas, there is evidence of even older periods of crust formation. Crust thickness is related to age; consequently, within limits, the age of the seafloor is an important consideration in assessing the resource potential of an area. However, crust thickness does not ensure high cobalt and nickel concentrations.

The U.S. Geological Survey found thick crusts with moderate cobalt, manganese, and nickel concentrations on Necker Ridge, which links the Mid-

Table 2-6.—Average Chemical Composition for Various Elements of Crusts From <8,200 Feet Water Depth From the EEZ of the United States and Other Pacific Nations (all data are in weight percent)

Areas	n	Mn	Fe	Co	Ni	Cu	Pb	Ti	SiO ₂	P ₂ O ₅	Fe/Mn
Hawaii and Midway (on axis)	2-38	24	16.0	0.91	0.45	0.05		1.1	7.9	—	0.73
Hawaii and Midway (off axis)	4-15	21	18.0	0.60	0.37	0.10	0.18	1.3	16.0	1.0	0.88
Johnston Island	12-40	22	17.0	0.70	0.43	0.11	0.17	1.3	12.0	1.2	0.81
Palmyra Atoll-Kingman Reef	7-8	27	16.0	1.1	0.51	0.06	0.17	1.1	5.5	1.9	0.61
Howland-Baker Islands	3	29	18.0	0.99	0.63	0.08	0.14	1.2	6.2	1.7	0.64
Marshall Islands	5-13	26	14.0	0.94	0.56	0.13	0.25	1.1	5.6	0.90	0.56
Average central Pacific crusts	34-117	23	17.0	0.81	0.45	0.09	0.18	1.2	9.1	1.3	0.75
Northern Marianna Islands (and Guam)	6-7	12	16.0	0.09	0.13	0.05	0.07	—	—	—	1.41
Western U.S. borderland	2-5	19	16.0	0.30	0.30	0.04	0.15	0.31	17.0	—	0.95
Gulf of Alaska Seamounts	3-6	26	18.0	0.47	0.44	0.15	0.17	0.57	—	0.87	0.72
Lau Basin (hydrothermal)	2	46	0.600	0.007	0.005	0.02	0.006	0.005	—	0.05	0.01
Tonga Ridge and Lau Basin (hydrogenous)	6-9	16	20.0	0.33	0.22	0.05	0.16	1.0	—	1.0	1.26
South China Sea	14	13	13.0	0.13	0.34	0.04	0.08	—	14.0	—	1.07
Benin Island area (Japan)	1-10	21	13.0	0.41	0.55	0.06	0.12	0.67	4.9	0.82	0.70
French Polynesia	2-9	23	12.0	1.2	0.60	0.11	0.26	1.0	6.5	0.34	0.56
Average for Pacific hydrogenous crusts (all data from figures 2-8) . . .	55-319	22	15.0	0.63	0.44	0.08	0.16	0.98	11.0	1.1	0.81

n = Number of analyses for various elements.

— = No data.

SOURCE: J.R. Hein, L.A. Morgenson, D.A. Clague, and R.A. Koski, "Cobalt-Rich Ferromanganese Crusts From the Exclusive Economic Zone of the United States and Nodules From the Oceanic Pacific," D. Scholl, A. Grantz, and J. Vedder (eds.), *Geology and Resource Potential of the Continental Margins of Western North American and Adjacent Ocean Basins: American Association of Petroleum Geologists, Memoir*, in press.

Pacific Mountains and the Hawaiian Archipelago.⁵⁷ Further, high cobalt values of 2.5 percent were found in the top inch or so of crusts from the S.P. Lee Seamount at 8° N. latitude. These deposits occur at depths coincident with a water mass that contains minimum concentrations of oxygen, leading most investigators to attribute part of this cobalt enrichment to low oxygen content in the seawater environment. However, high cobalt values (greater than 1 percent) have also been found in the Marshall Islands, the western part of the Hawaiian Ridge province, and in French Polynesia, all of which are outside the well-developed regional equatorial oxygen-minimum zone but which appear to be associated with locally developed oxygen-minimum zones. Oxygen-minimum zones are also associated with low iron/manganese ratios. Figure 2-12 illustrates the zone of cobalt enrichment in ferromanganese crusts on seamounts and volcanic islands. In general, while progress is being made to understand more fully the physical and geochemical mechanisms of cobalt-manganese crust forma-

tion, the cobalt enrichment process is still uncertain. Investigations to gain insight in this area will be of considerable benefit in identifying future resources.

Surface texture, slope, and sediment cover also may influence crust growth rates. For example, sediment-free, current-swept regions appear to be favorable sites for crust formation.

Nodules are also found associated with cobalt-rich manganese crusts in some areas. These nodules are similar in composition to the crusts and, consequently, differ from their deep ocean counterparts. Another difference between crust-associated nodules and deep ocean nodules is the greater predominance of nucleus material in the crust-associated nodules. The cobalt-rich nodules generally occur as extensive fields on the tops of seamounts or within small valleys and depressions. While of much lesser extent overall than crust occurrences, these nodules may prove more easily recoverable and, hence, possibly of nearer term economic interest.

Prospects for Future Development

The geologic considerations mentioned previously are important determinants in assessing the

⁵⁷J. R. Heine, et al., "Geological and Geochemical Data for Seamounts and Associated Ferromanganese Crusts In and Near the Hawaiian, Johnston Island, and Palmyra Island Exclusive Economic Zones," U.S. Geological Survey, *Open File Report 85-292, 1985*, p. 129.

Figure 2-12.—EEZs of U.S. Insular and Trust Territories in the Pacific

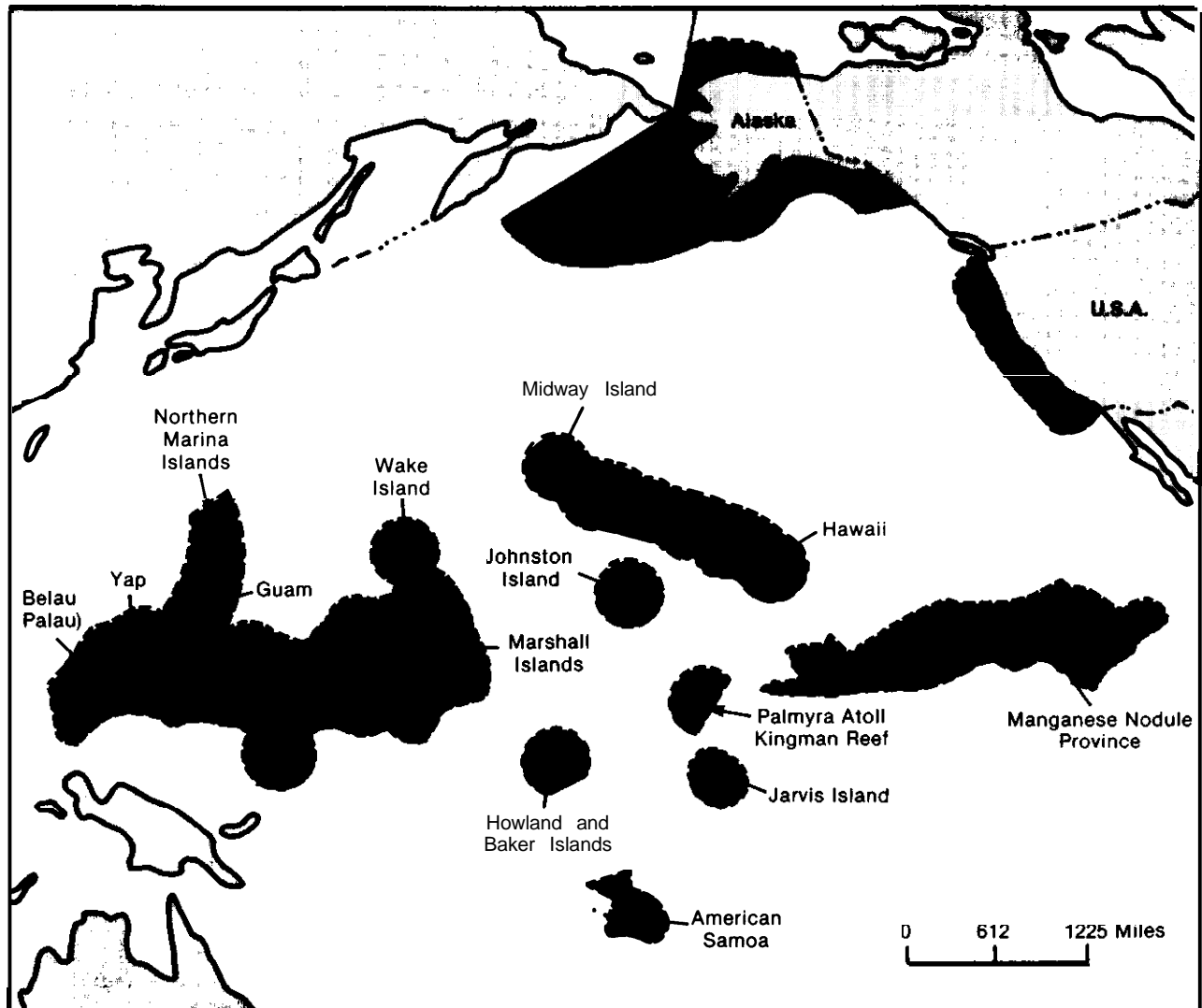

In addition to the waters off the fifty states, the Exclusive Economic Zone includes the waters contiguous to the insular territories and possessions of the United States. The United States has the authority to manage these economic zones to the extent consistent with the legal relationships between the United States and these islands.

SOURCES: Office of Technology Assessment, 1957; J.R. Hein, L.A. Morgenson, D.A. Clague, and R.A. Koski, "Cobalt-Rich Ferromanganese Crusts From the Exclusive Economic Zone of the United States and Nodules From the Oceanic Pacific," in D. Scholl, A. Grantz, and J. Vedder, eds., "Geology and Resource Potential of the Continental Margin of Western North America and Adjacent Ocean Basins," American Association of Petroleum Geologists Memoir 43, in press.

resource potential of cobalt-rich ferromanganese crusts. Using three primary assumptions based on these factors, the East West Center in Hawaii produced a cobalt-rich ferromanganese crust resource assessment for the Minerals Management Service.⁵⁸ The first assumption was that commer-

cial concentrations of cobalt-rich crusts would be confined to the slopes and plateau areas of seamounts in water depths between 2,600 and 7,900 feet. The second assumption was that commercial concentrations would be most common in areas older than 25 million years, where both generations of crust would be found, and less common in areas younger than 10 million years, where only thinner younger crust generation occurs. The third primary assumption was that commercial concen-

⁵⁸A. L. Clark, P. Humphrey, C. J. Johnson, et al., *Cobalt-Rich Manganese Crust Potential*, OCS Study, MMS 85-0006, U.S. Department of the Interior, Minerals Management Service, 1985, 35 pp.

Table 2-7.—Resource Potential of Cobalt, Nickel, Manganese, and Platinum in Crusts of U.S. Trust and Affiliated Territories

Territory	Resource Potential			
	Cobalt (t x 10 ⁶)	Nickel	Manganese	Platinum (oz x 10 ⁶)
Belau/Palau	0.55	0.31	15.5	0.68
Guam	0.55	0.31	15.5	0.68
Howland-Baker	0.19	0.11	5.5	0.48
Jarvis	0.06	0.03	1.6	0.15
Johnston Island	1.38	0.69	41.6	3.50
Kingman—Palmyra	3.38	1.52	76.1	5.70
Marshall Islands.	10.55	5.49	281.3	21.50
Micronesia.	17.76	9.96	496.0	34.70
Northern Mariana Islands	3.60	1.97	100.2	7.70
Samoa	0.03	0.01	0.8	0.04
Wake	0.98	0.51	26.8	2.00

NOTE: The above are estimates of in-place resources and as such do not indicate either potential recoverability or mineable quantities.

SOURCE: Allen L. Clark, Peter Humphrey, Charles J. Johnson, and Dorothy K. Pak, *Cobalt-Rich Manganese Crust Potential*, OCS Study MMS 65-0006, 1985, p. 20.

trations would be most common in areas of low sediment cover that have been within the geographically favorable equatorial zone for the majority of their geologic history.

The East-West Center's procedure was to use detailed bathymetric maps to determine permissive areas for each EEZ of the U.S. Trust and Affiliated Territories in the Pacific. The permissive areas included all the seafloor between the depths of 2,600 and 7,900 feet, making corrections for areas of significant slopes. Then, based on published data, the metal content and thickness of crust occurrences for each area were averaged. Crust thicknesses were also assigned on the basis of ages of the seamounts, guyots, and island areas. Seamounts older than 40 million years were assigned a thickness of 1 inch. Seamounts younger than 10 million years were assigned a thickness of one-half inch, and seamounts younger than 2 to 5 million years were not included in the resource calculations. These data are summarized in table 2-7.

According to table 2-7, the five territories of highest resource potential would be the Federated States of Micronesia, Marshall Islands, Commonwealth of the Northern Mariana Islands, Kingman-Palmyra Islands, and Johnston Island. Further geologic inference suggests that the resource potential of the Federated States of Micronesia and the Commonwealth of the Northern Mariana Islands

could be reduced because of uncertainties in age and degree of sediment cover. Thus, according to their more qualitative assessment, the largest resource potential for cobalt crusts would likely be in the Marshall Islands, followed by the Kingman-Palmyra, Johnston, and Wake Islands (figure 2-13). The territories of lesser resource potential would include, in decreasing order, the Federated States of Micronesia, Commonwealth of the Northern Mariana Islands (figure 2-14), Belau-Palau, Guam, Howland-Baker, Jarvis, and Samoa.⁵⁹

Another assessment of crust resource potential using grade and permissive area calculations with geologic and oceanographic criteria factored in is given in table 2-8.⁶⁰ This assessment is also a qualitative ranking without attempting to quantify tonnages. In this regard, other factors that would have to be considered to assess the economic potential of any particular area include: nearness to port facilities and processing plants, and the cost of transportation. In addition, factors highly critical to the economics of a potential crust mining operation would be the degree to which the crust can be separated from its substrate and the percentage of the

⁵⁹Ibid., p. 21.

⁶⁰J. R. Hein, L.A. Morgenson, D.A. Glague, and R.A. Koski, "Cobalt-Rich Ferromanganese Crusts From the Exclusive Economic Zone of the United States and Nodules From the Oceanic Pacific, D. Scholl, A. Grantz, and J. Vedder (eds.), *Geology and Resource Potential of the Continental Margins of Western North America and Adjacent Ocean Basins*, American Association of Petroleum Geologists, Memoir (in press), 1986.

Table 2-8.—Estimated Resource Potential of Crusts Within the EEZ of Hawaii and U.S. Trust and Affiliated Territories

Pacific area	Relative banking	Potential
Marshall Islands.	1	High
Micronesia	2	High
Johnston Island	3	High
Kingman-Palmyra.	4	High
Hawaii-Midway	5	Medium
Wake	6	Medium
Howland-Baker.	7	Medium
Northern Mariana Islands.	8	Low
Jarvis	9	Low
Samoa	10	Low
Belau/Palau.	11	Low
Guam	12	Low

SOURCE: Modified from J.R. Hein, F.T. Manheim, and W.C. Schwab, *Cobalt-Rich Ferromanganese Crusts from the Central Pacific*, OTC 5234, Offshore Technology Conference, May 1966, pp. 119126.

Figure 2-13.—Potential Hard Mineral Resources of U.S. Insular Territories South of Hawaii

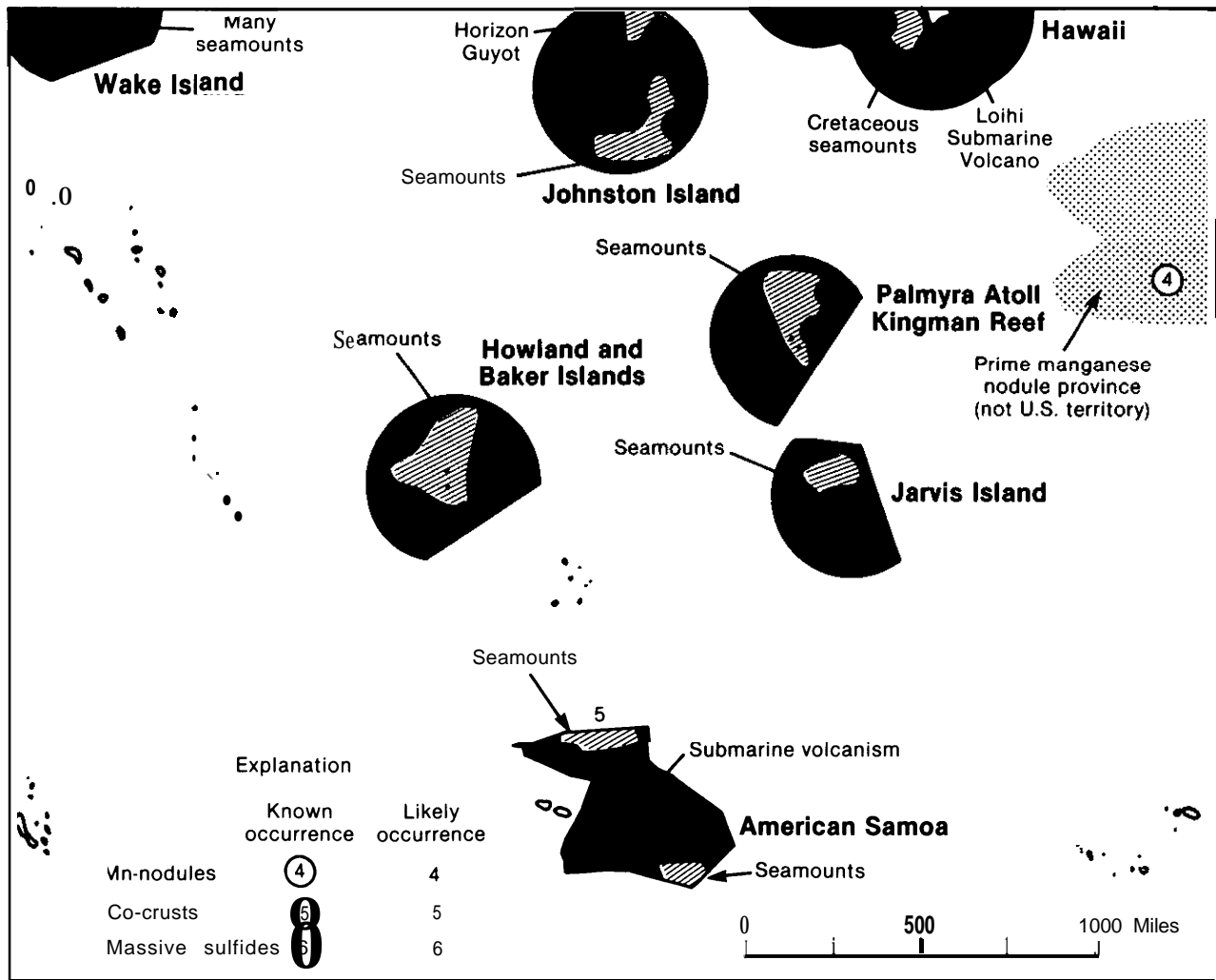

SOURCES: Office of Technology Assessment, 1987; U.S. Department of the Interior, "Symposium Proceedings—A National Program for the Assessment and Development of the Mineral Resources of the United States Exclusive Economic Zone," U.S. Geological Survey Circular 929, 1983.

area that could not be mined because of roughness of small-scale topography. When asked to place the stage of knowledge of the economic potential of cobalt crusts on the time-scale experienced in the investigations of manganese nodules, one leading researcher chose 1963.⁶¹

⁶¹J. M. Broadus, *Seabed Mining*, report to the Office of Technology Assessment, U.S. Congress, Feb. 14, 1984, p. 24.

Manganese Nodules

Ferromanganese nodules are found at most water depths from the continental shelf to the abyssal plain. Since the formation of nodules is limited to areas of low sedimentation, they are most common on the abyssal plain. Nodules on the abyssal plain are enriched in copper and nickel and, until recently, have been regarded as candidates for commercial recovery. Nodules found on topographic highs in the Pacific are enriched in cobalt and were mentioned in the previous section.

Figure 2-14.—Potential Hard Mineral Resources of U.S. Insular Territories West of Hawaii

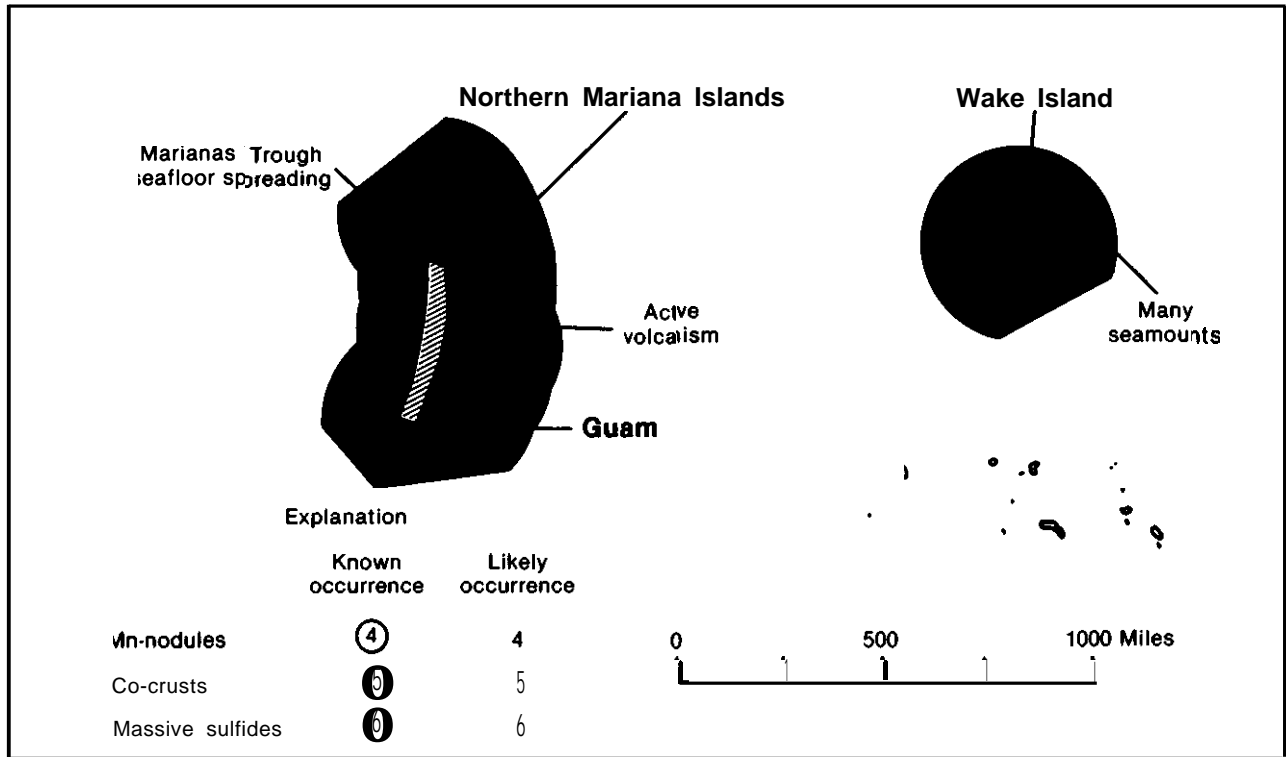

SOURCES: Office of Technology Assessment, 1987; U.S. Department of the Interior, "Symposium Proceedings-A National Program for the Assessment and Development of the Mineral Resources of the United States Exclusive Economic Zone," U.S. Geological Survey Circular 929, 1983.

The prime area considered for commercial recovery of nodules in the Pacific lies in international waters between the Clarion and Clipperton fracture zones in the mid-Pacific ocean. However, several other smaller areas may contain suitable mine sites, for example, southwest of Hawaii. A mine site should have an average grade of about 2.25 percent copper plus nickel with 20 pounds of nodules

per square yard to be commercially interesting. Because of uncertainties brought about by the United Nations Law of the Sea Convention in regard to mining in international waters, and because of the low price of copper on the world market, the recovery of nodules from the Clarion-Clipperton region is not attractive at this time.

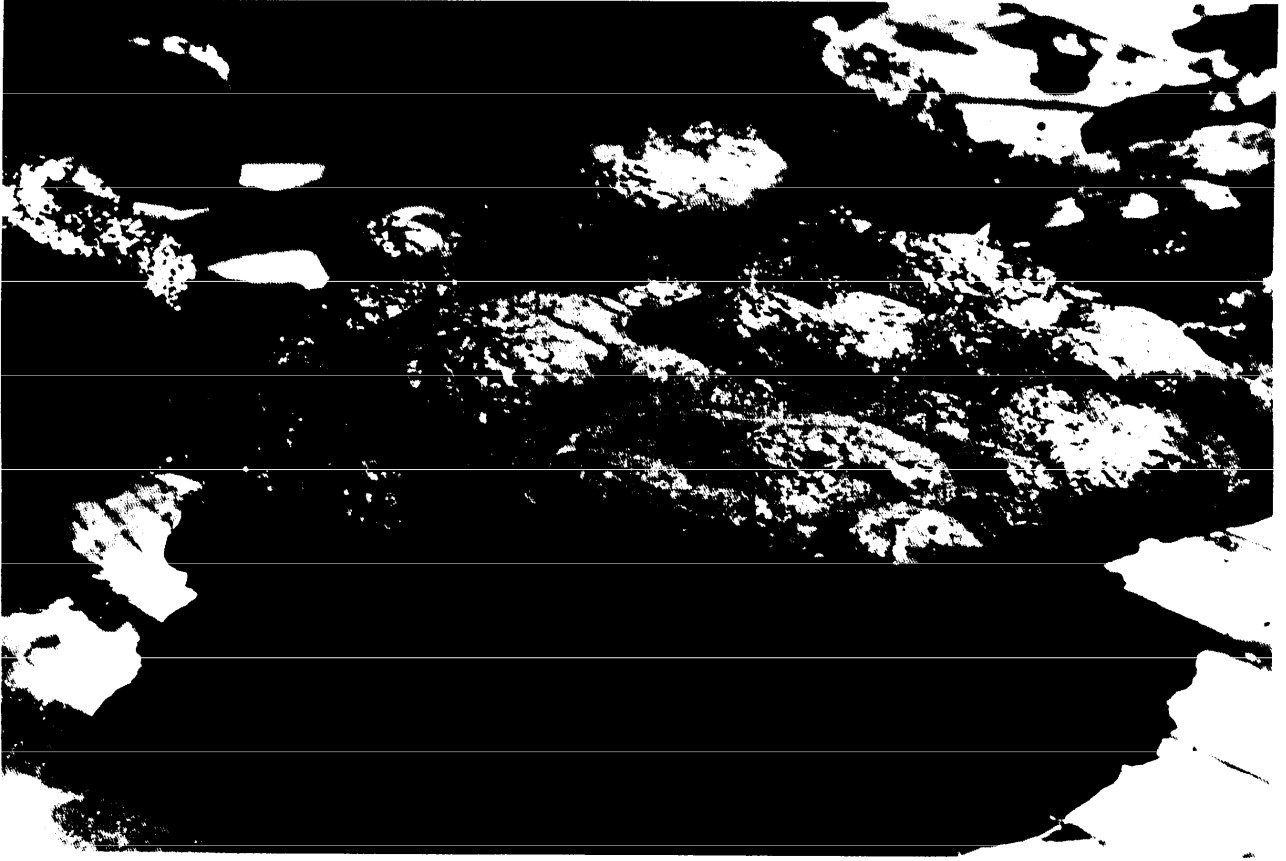

Foo

C W m m g m m bee d m d p dg d m mm m ry w P d O
d m d g p g rf m b



Photo credit: National Oceanic and Atmospheric Administration

Manganese nodules on the seafloor. Ferromanganese nodules have been studied extensively as a potential source of copper, nickel, cobalt, and manganese. Prototype mining systems have successfully recovered several tons of nodules from sites such as this, but full-scale mining systems have not been built and tested.

Current market conditions do not encourage further commercial development.

Chapter 3
**Minerals Supply, Demand,
and Future Trends**

CONTENTS

	<i>Page</i>
Introduction	81
Trends in Minerals Consumption	81
Commodity Prices	83
State of the Mining Industry	85
Ferroalloys	86
National Defense Stockpile	87
Substitution, Conservation, and Recycling	88
Major Seabed Mineral Commodities	89
Cobalt	89
Chromium	90
Manganese	94
Nickel	95
Copper	97
Zinc	99
Gold	100
Platinum-Group Metals	102
Titanium (Ilmenite and Rutile)	104
Phosphate Rock (Phosphorite)	107
Sand and Gravel	111
Garnet	112
Monazite	112
Zircon	112

Box

<i>Box</i>	<i>Page</i>
3-A. Government Sources of Information and Units of Measure Used in This Report	82

Figures

<i>Figure No.</i>	<i>Page</i>
3-1. Actual and Projected Consumption of Selected Minerals in the Market-Economy Countries	82
3-2. Price Trends for Selected Seabed Mineral Commodities	84
3-3. Cobalt Prices, 1920-85	85
3-4. U.S. Ferrochromium and Chromate Ore Imports	87
3-5. Percentage of Manganese Imported Into the United States as Ferromanganese, 1973-86	94

<i>Figure No.</i>	<i>Page</i>
3-6. World Titanium Pigment Manufacturing Capacity	105
3-7. Major World Exporters of Phosphate Rock Since 1975, With Projections to 1995	108

Tables

<i>Table No.</i>	<i>Page</i>
3-1. Major U.S. Strategic Materials Contained in the National Defense Stockpile	88
3-2. Forecast of U.S. and World Cobalt Demand in 2000.	90
3-3. 1986 National Defense Chromium Stockpile Goals and Inventories	91
3-4. Forecasts for U.S. Chromium Demand in 2000.	93
3-5. Status of Manganese in the National Defense Stockpile-1986	95
3-6. Forecast for U.S. and World Manganese Demand in 2000	96
3-7. Forecast of U.S. and World Nickel Demand in 2000.	97
3-8. U.S. and World Copper Demand in 2000.	99
3-9. Forecast of U.S. and World Zinc Demand in 2000.	100
3-10. Platinum-Group Metals in the National Defense Stockpile	102
3-11. Forecast of Demand for Platinum-Group Metals in 2000	103
3-12. U.S. Titanium Reserves and Reserve Base	105
3-13. Forecast for U.S. Titanium Demand in 2000.	106
3-14. World and U.S. Phosphate Rock Production	108
3-15. World Phosphate Rock Reserves and Reserve Base.	109
3-16. Forecasts of U.S. and World Phosphate Rock Demand in 2000.	110

Minerals Supply, Demand, and Future Trends

INTRODUCTION

Commodities, materials, and mineral concentrates—the stuff made from minerals—are actively traded in international markets. An analysis of domestic demand, supply, and prices of minerals and their products must also consider future global supply and demand, and international competition. This is important to all mining and minerals ventures, but particularly so for seabed minerals, which must not only compete with domestically produced land-based minerals, but which must also match the prices of foreign onshore and offshore producers.¹

The commercial potential of most seabed minerals from the EEZ is uncertain. Several factors make analysis of their potential difficult, if not impossible:

- First, very little is known about the extent and grade of the mineral occurrences that have been identified thus far in the EEZ.
- Second, without actual experience or pilot operations, the mining costs and the unforeseen operational problems that affect costs cannot be assessed accurately.
- Third, unpredictable performance of domestic and global economies adds uncertainty to forecasts of minerals demand.
- Fourth, changing technologies can cause unforeseen shifts in demand for minerals and materials.
- Fifth, past experience indicates that methods for projecting or forecasting minerals demand

¹J. Broadus, "Seabed Materials," *Science*, vol. 235, Feb. 20, 1987, p. 835.

fall short of perfection and are sometimes incorrect or misleading.

Mineral commodities demand is a function of demand for construction, capital equipment, transportation, agricultural products, and durable consumer goods. These markets are tied directly or indirectly to general economic trends and are notably unstable. With economic growth as the "common denominator" for determining materials consumption and hence minerals demand, and with recognition of the shortcomings in predicting global economic changes, any hope for reasonably accurate forecasts evaporates.

It is probably unwise to even attempt to speculate on the future commercial viability of seabed mining, but few can resist the temptation to do so. The case of deep seabed manganese nodule mining offers a graphic example of how external international and domestic political events and economic factors can affect the business climate and economic feasibility of offshore mining ventures. After considerable investment in resource assessments, development and testing of prototype mining systems, and detailed economic and financial analyses, the downturn of the minerals markets from the late 1970s through the 1980s continues to keep the mining of seabed manganese nodules out of economic reach, although many of the international legal uncertainties once facing the industry have been eliminated through reciprocal agreements among the ocean mining nations. As a consequence, several deep seabed mining ventures have either shrunk their operations or abandoned their efforts altogether.

TRENDS IN MINERALS CONSUMPTION

Minerals consumption for a product is determined by the number of units manufactured and the quantity of metal or material used in each unit. Total demand is influenced by the mix of goods

consumed in the economy (product composition), because each consumes different materials as well as different amounts of those materials. Finally, minerals demand is closely related to macroeconomic

activity, consumer preference, changing technologies, prices, and other unpredictable factors (see box 3-A).

Long-term demand is difficult to forecast. Simple projections of consumption trends may be misleading (figure 3-1).² From the late 1970s through

²J. Tilton, "Changing Trends in Metal Demand and the Decline of Mining and Mineral Processing in North America," paper presented at Colorado School of Mines Conference on Public Policy and the Competitiveness of U.S. and Canadian Metals Production, Golden, CO, Jan. 27-30, 1987.

Box 3-A.—Government Sources of Information and Units of Measure Used in This Report

The U.S. Bureau of Mines compiles statistics related to production, demand, and availability of minerals and mineral commodities. The U.S. Geological Survey compiles information and data about domestic and world mineral resources. Both are agencies of the U.S. Department of the Interior which has responsibility for managing the resources of the Outer Continental Shelf (OCS) and the continental shelf lands. The Minerals Management Service (MMS) administers the OCS program, and the Bureau of Land Management (BLM) administers the shelf lands within the Department of the Interior.

Information from mines and manufacturing is also available from the International Trade Administration (ITA), an agency of the Department of Commerce. The National Bureau of Economic Administration (NBEA), another Commerce agency, is responsible for statistics and services related to the economic development and resource science; it is also a resource information agency for the resources of the OCS.

Although commodity statistics are often reported in metric units, some weights depending on commodity may be denoted in all tonnage units. Weights in all tonnage units (2,000 pounds) in this report, unless otherwise specified, all units of the metric system are "short ton." Weights are reported in metric units through some mineral data. For example, titanium dioxide (TiO₂) is reported in metric tons.

Figure 3-1.—Actual and Projected Consumption of Selected Minerals in the Market-Economy Countries (1950-85)

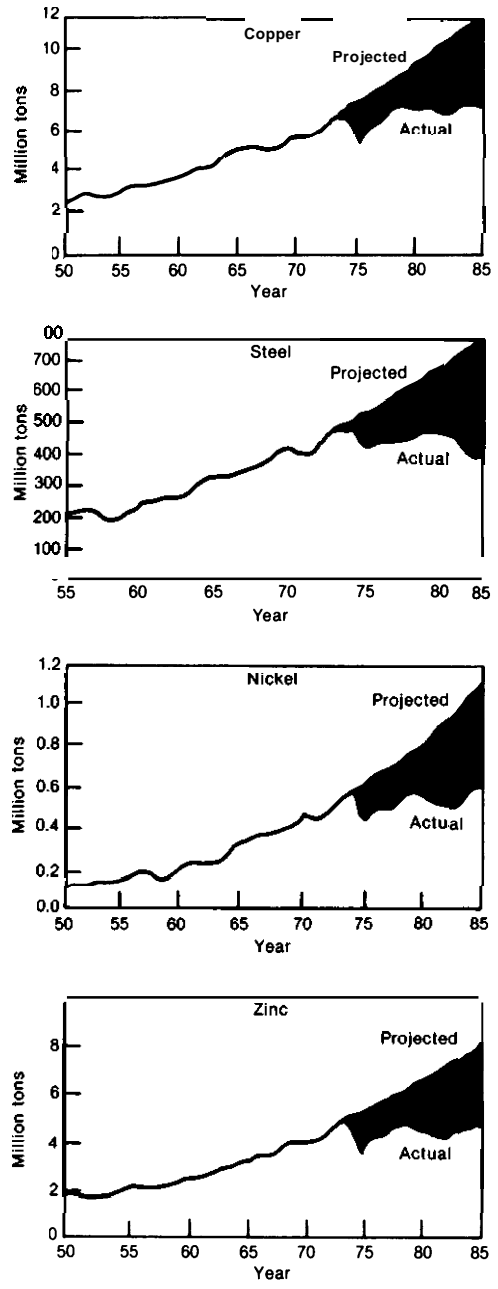

Changes in the world economy since 1973 have made it difficult to forecast the long-term consumption of metals by the Market-Economy Countries.

SOURCE: J. Tilton, "Changing Trends in Metal Demand and the Decline of Mining and Mineral Processing in North America," paper presented at a conference on public Policy and the Competitiveness of U.S. and Canadian Metals Production, Colorado School of Mines, Jan. 27-30, 1987 (modified).

middle 1980s, unforeseen changes in the world economy significantly altered consumption; these changes were partially caused by economic pressures resulting from substantial increases in energy prices, coupled with technological advancements (including substitution), changes in consumer attitude, imports of finished products rather than raw materials, and growth in the service sector of the U.S. economy.

These shifts in minerals demand are reflected in both the intensity of use and in consumption.³ Of

³ Intensity of use, as used in this report, is the quantity of metal consumed per constant dollar output.

the major industrial metals derived from minerals known to occur in the U.S. EEZ, only two—platinum and titanium—show growth in domestic consumption between 1972 and 1982. Whether the long-term trends in use intensity and consumption will continue, stabilize, or recover depends on many complex factors and unpredictable events that confound even the most sophisticated analyses. However, there are indications that trends in reduced intensity of use and consumption for some metals, e.g., nickel, have stabilized since 1982.

COMMODITY PRICES

For most minerals, the normal forces of supply and demand resulting from macroeconomic trends determine the market price.⁴ Mineral prices and

demand are notably volatile (figure 3-2). While all minerals are subject to some oscillations in market prices due to normal economic events, some that are produced by only a few sources (where there is a relatively low level of trade, e.g., cobalt) and

⁴ Broadus, "Seabed Materials," p. 857.



Photo credit: Jenifer Robison

Considerable onshore mining capacity remains idle as a result of depressed mineral prices, foreign competition, and reduced demand. Idle capacity will likely be brought back into production to satisfy increased future consumption before new mining operations are begun either onshore or offshore.

Figure 3-2.—Price Trends for Selected Seabed Mineral Commodities

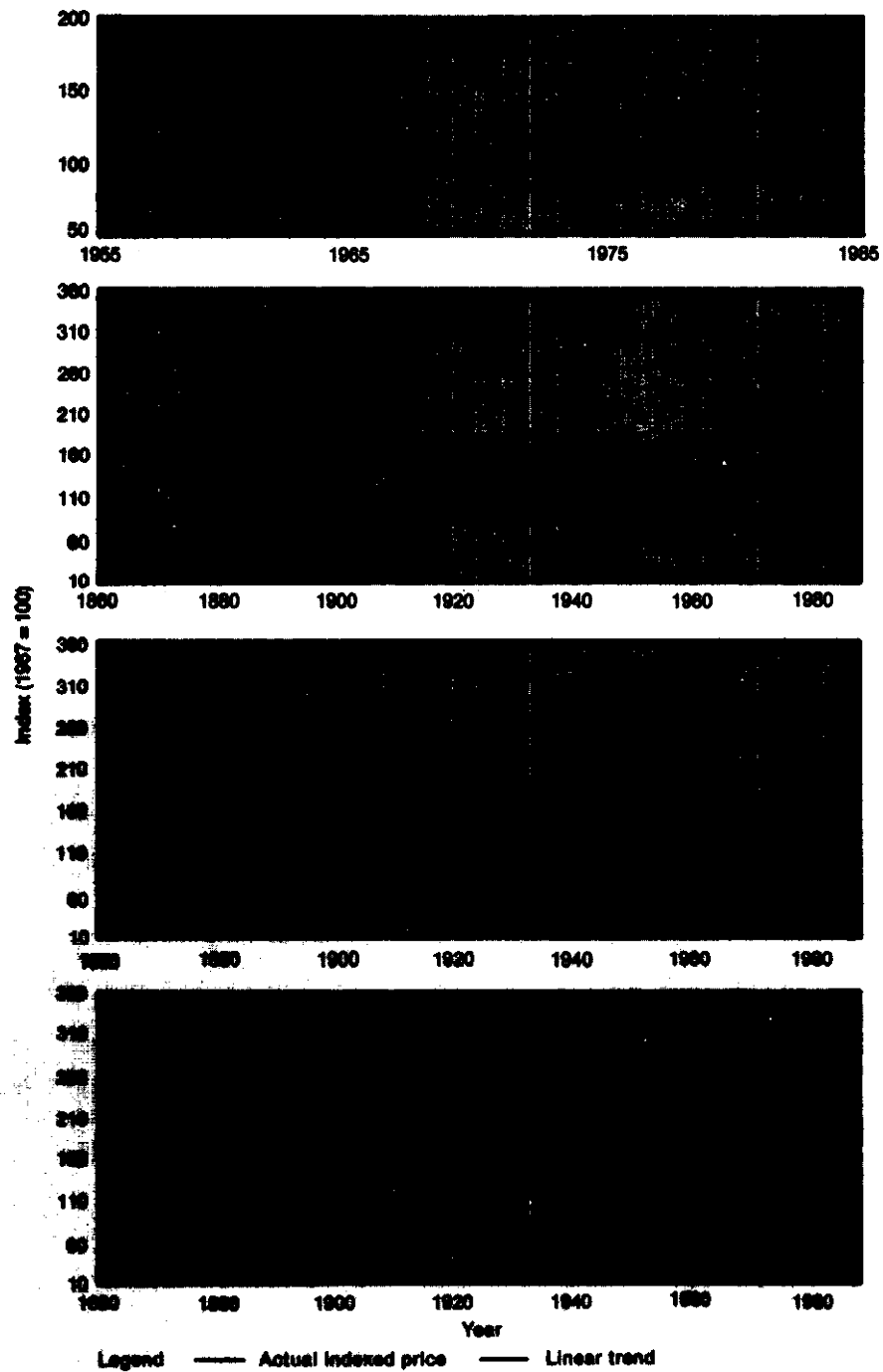

Prices of several commodities that are derived from minerals known to occur on the seabed within the U.S. EEZ can change abruptly in world markets.

SOURCE: J.M. Broadus, "Seabed Materials," *Science*, vol. 235, Feb. 20, 1987, p. S57 (modified and abbreviated).

those that are targets of speculators (e. g., the precious metals) undergo drastic and often unpredictable swings in price. Although attempts at forming mineral cartels similar to Organization of Petroleum Exporting Countries (OPEC) in order to stabilize prices have generally failed eventually, e.g., attempts by Morocco to control the production and price of phosphate rock and the International Tin Council's effort to stabilize tin prices, they nevertheless can trigger serious price disruptions.⁵ Speculative surges, such as that encountered by silver in 1979-80, also can have tremendous impacts on price structure.

In addition, unforeseen supply interruptions or the fear of such interruptions can drive the price of commodities up. The short-lived guerrilla invasion of the Zairian province of Shaba in 1977 and 1978, had a psychological effect on cobalt consumers that sent prices up from \$6.40 per pound in February 1977 to \$25 per pound in February 1979, although the invasion caused little interruption in production and Zairian cobalt production actually increased in 1978 (figure 3-3).⁶ Threats of a possible cutoff of the supply of platinum-group metals from the Republic of South Africa, resulting from U.S. sanctions against apartheid, recently caused similar increases in the market price of platinum.

⁵S. Strauss, *Trouble in the Third Kingdom* (London, U. K.: Mining Journal Books, Ltd., 1986), p. 116; see also, K. Hendrixson and J. Schanz, Jr., *International Mineral Market Control and Stabilization: Historical Perspectives, 86-601 S* (Washington, DC: Congressional Research Service, 1986).

⁶Office of Technology Assessment, *Strategic Materials: Technologies to Reduce U.S. Import Vulnerability, OTA-ITE-248* (Washington, DC: U.S. Congress, 1985), pp. 97-104; see also, W. Kirk "A Third Pricing Phase: Stability?" *American Metal Market*, Aug. 23, 1985, pp. 9-12.

Figure 3-3.—Cobalt Prices, 1920-85

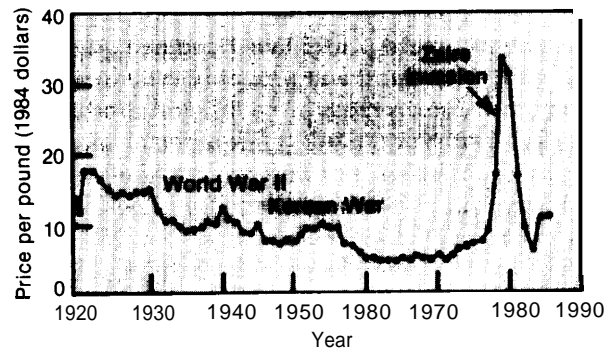

Cobalt is a good example of how mineral commodity prices can be affected by the fear of a supply interruption. Although supplies of cobalt were only briefly interrupted during the Shaba guerrilla uprising in Zaire, the psychological impact on traders caused cobalt prices to skyrocket from 1978 to 1979.

SOURCE: F. Manheim, "Marine Cobalt Resources," *Science*, vol. 232, May 2, 1956.

Such commodity price fluctuations pose significant economic uncertainties for investors in new mineral developments, including seabed mining. Macroeconomic cycles coupled with macroeconomic disruptions within the minerals sector make planning difficult and the business future uncertain.

Nonmetallic minerals, while not completely immune from downturns in the business cycle, as a whole have fared better than metals in recent years. The prices of phosphate rock, sulfur, boron, diatomite, and salt have all increased at a higher rate than has inflation since 1973, whereas only the prices of tin (temporarily) and certain precious metals have matched that performance among the non-ferrous metals.⁷ However, all mineral prices fluctuated greatly during that period.

⁷Strauss, *Trouble in the Third Kingdom*, p. 140.

STATE OF THE MINING INDUSTRY

The downturn in the world minerals industry into the 1980s had a combination of causes:

- First, there has been a long-term (but only recently recognized) trend toward less metal-intensive goods.
- Second, growth has slackened in per capita consumption of consumer goods and capital expenditures.

- Third, developing countries' economies have not expanded to the point that they have become significant consumers, while at the same time some of these countries have become low-cost mineral producers competing with traditional producers in the industrialized countries.
- Fourth, petroleum companies diversified by investing in minerals projects that turned out

to be poor investments due to the 1982-83 recession.⁸

As a result, metal prices have remained quite low during the 1980s and will probably remain so until demand absorbs the unused mineral production capacity. The World Bank Index of metal and mineral prices indicates that the constant-dollar value of mineral prices in the 1981 to 1985 period was 19 percent below the value from 1975 to 1979 and 37 percent lower than the years 1965 through 1974.⁹ To survive these prices, the domestic industry has undergone a significant shakedown and restructuring, coupled with cuts in operations to improve efficiency. While the surviving firms may emerge as stronger competitors, their ability and willingness to invest in future risky ventures such as seabed mining are likely to be limited.

Recent increases in the number of government-owned or state-controlled foreign mining ventures have added a new twist to the structure of the world

⁸Tilton, "Changing Trends in Metal Demand. "

⁹World Bank, Commodities Division, "Primary Commodity Price Forecasts, Aug. 18, 1986.

mining industry. The domestic industry tends to blame state-owned producers for ignoring market forces and maintaining production despite low prices or supply surpluses. There is some evidence that state-owned operators may continue production in order to maintain employment or generate much-needed hard currency.¹⁰

Until recently, production costs in the United States have been well above the world average. Overvalued currency (high value of the dollar) during 1981-86 also may have contributed to making North American production less competitive. These factors may have masked any effect that state ownership might have played in distorting the world market.¹¹ Nevertheless, domestic competition with state-owned mining ventures is a trend that will likely continue in the future.

¹⁰M. Radetzki, "The Role of State Owned Enterprises in the International Metal Mining Industry, paper presented at Conference on Public Policy and the Competitiveness of U.S. and Canadian Metals Production, Colorado School of Mines, Golden, CO, Jan. 27-30, 1987, p. 15.

¹¹J. Ellis, "Copper," *The Competitiveness of American Metal Mining and Processing* (Washington, DC: Congressional Research Service, 1986). p. 17.

FERROALLOYS

Manganese, chromium, silicon, and a number of other alloying elements are used to impart specific properties to steel. Manganese is also used to reduce the sulfur content of steel and silicon is a deoxidizer. Most elements are added to molten steel in the form of ferroalloys, although some are added in elemental form or as oxides. Ferroalloys are intermediate products made of iron enriched with the alloying element. Ferromanganese, ferrochromium, and ferrosilicon are the major ferroalloys used in the United States. There are no domestic reserves of either manganese or chromium; therefore the United States must import all of these alloying elements.

U.S. ferroalloy producers have lost domestic markets to cheaper foreign sources. Higher domestic operating costs related to electric power rates, labor rates, tax rates, transportation costs, and regulatory costs have given foreign producers a competitive edge.

As a result, the form of U.S. chromium imports has changed during the last decade. Since 1981, the United States has imported more finished ferroalloys and metals than chromite (figure 3-4). Domestic production of chromium ferroalloys has decreased steadily since 1973, when 260,000 tons (chromium content) of ferroalloy was produced, to 59,000 tons in 1984 (largely conversion of stockpiled chromite).¹² Foreign producers now supply U.S. markets with about 90 percent of the high-carbon ferrochromium consumed and all of the ore used domestically for the manufacture of chemicals and refractories.

This shift from imports of ores and concentrates to imports of ferrochromium and finished metals could have important strategic implications. Since 1975, an increasing number of ferrochromium

¹²R. Brown and G. Murphy, "Ferroalloys," *Mineral Facts and Problems—1985 Edition, Bulletin 675* (Washington, DC: U.S. Bureau of Mines, 1986), p. 269.

plants have been built close to sources of chromite ores in distant countries, such as the Republic of South Africa, Zimbabwe, Greece, the Philippines, Turkey, India, and Albania. This trend in the movement of ferrochromium supply is expected to continue. Decline of U.S. ferroalloy production capacity in relation to demand will likely make the United States nearly totally dependent on foreign processing capacity in the future.

Domestic demand for ferroalloys is related to steel production. Domestic steel capacity fell by almost 50 million tons (30 percent) between 1977 and 1987. Iron castings capacity also has shrunk considerably in recent years. In 1986, the United States imported about 21 percent of its iron and steel. The decline in domestic steel production has also reduced the domestic demand for ferroalloys. With the decreases in both U.S. ferroalloy production and iron and steel production, demand for chromium and manganese ores for domestic production of ferroalloys is likely to continue to decline proportionately.

Figure 3-4.—U.S. Ferrochromium and Chromite Ore Imports

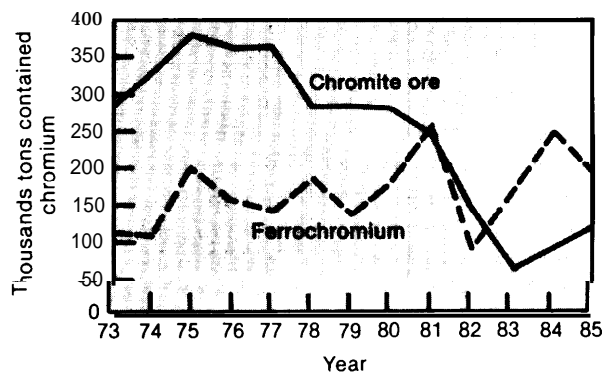

The United States is now importing significantly more chromium in the form of ferrochromium and as stainless steel than as chromite ore. This trend of increasing ferrochromium imports is threatening the existence of the domestic ferrochromium industry, and some analysts predict the extinction of the U.S. industry in the near future.

SOURCE: Office of Technology Assessment, 1987.

NATIONAL DEFENSE STOCKPILE

In 1939, Congress authorized stockpiling of critical materials for national security. World War II precluded the accumulation of stocks, and it was not until the Korean War that materials stockpiling began in earnest. Since that time, U.S. stockpile policy has been erratic and subject to periodic, lively debate. Past presidents have supported stockpiling critical materials for times of emergency, but some have favored disposal of some of the stockpiled items for fiscal or budgetary reasons. The question of how much of each commodity should be retained in the stockpile remains a hotly debated issue.

Stockpile goals are currently based on the materials needed for critical uses for a 3-year period that are vulnerable to supply interruption. Some observers conclude that an increase in one unit of domestic production capacity from domestic reserves could offset three units of stockpiled materials. This view argues in favor of promoting domestic production of stockpiled materials where feasible so as to reduce the need for emergency stockpiling. Sev-

eral seabed minerals, including cobalt, manganese, and chromium could be considered as candidates for special treatment if government policies were to shift away from emergency stockpiling toward economic support of marginal resource development for strategic and critical purposes. To be considered a secure source of supply, however, marine mineral operations offshore would have to be protected from saboteurs or hostile forces.

The stockpiling program was overhauled in 1979 to create a National Defense Stockpile with a Transaction Fund that dedicates revenue received by the Federal Government from the sale of stockpile excesses to the purchase of materials short of stockpile goals.¹³ In 1986, the stockpile inventory was valued at approximately \$10 billion. If the stockpile met current goals, it would have a value of about \$16.6 billion.¹⁴ A number of materials de-

¹³Strategic and Critical Materials Stock Piling Act of 1979, Public Law 96-41, 50 U.S.C. 98 *et seq.*

¹⁴Federal Emergency Management Agency, *Stockpile Report to the Congress: October 1985-March 1986*, FEMA 36, 1986, p. 61.

rived from minerals known to occur within the U.S. EEZ are included in the stockpile: r-utile, platinum-group metals, chromium, lead, manganese, nickel, cobalt, zinc, chromium, copper, and titanium (table 3-1).

The stockpile program can affect minerals markets when there are large purchases to meet stockpile goals or sales of materials in excess of goals, although the authorizing legislation prohibits transactions that would disrupt normal marketing practices. Stockpile policies have on occasion opened additional markets for certain minerals, while at other times sales from the stockpile have significantly depressed some commodity prices. The mere existence of stockpile inventories can also have a psychological effect on potential mineral producers' actions.

SUBSTITUTION, CONSERVATION, AND RECYCLING

Changes in production technology can substantially affect minerals and materials use. Changes in use are generally made in response to economic incentives, although environmental regulations also have been instrumental in promoting some conservation and recycling. Cheaper materials or materials that perform better can replace their competitors by substitution. Similarly, there is significant motivation to reduce the amount of material used in a production process or to use it more efficiently. Finally, if the material is valuable enough to offset the cost of collecting, separating, and reclaiming scrap, there is an incentive to recycle the material through secondary processing. Each of these options can reduce the demand for primary minerals production.

Materials substitution is a continuing, evolutionary process where one material displaces another in a specific use. Examples of substitution abound. Steel has replaced wood for floor joists, studs, and siding in many construction applications. Plastics are replacing wood as furniture parts and finishes, many metals in non-stress applications, and steel in automobile bodies. Ceramics show promise for displacing carbide steels in some cutting tools and some internal combustion engine components. Glass fiber optics have replaced copper wire in some

Table 3-1.—Major U.S. Strategic Materials Contained in the National Defense Stockpile

Most vulnerable	Vulnerable	Less vulnerable
Chromium	Bauxite/alumina	Copper
Cobalt	Beryllium	Lead
Manganese	Columbium	Nickel
Platinum-group	Diamond (industrial)	Silver
	Graphite (natural)	Zinc
	Rutile	
	Tantalum	
	Tin	
	Titanium sponge	
	Vanadium	

SOURCE: Adapted from Federal Emergency Management Agency, *Stockpile Report to the Congress* (Washington, DC: Federal Emergency Management Agency, 1986), pp. 30-31.

telecommunications applications. At a more elemental level, there are other examples: manganese can partially substitute for nickel and chromium in some stainless steels; the increased use of nickel-based superalloys have reduced the quantity of cobalt used in aircraft engines; and, for some electronic applications, gold can replace platinum.

Conservation technologies can reduce the amount of metal used in the manufacturing process. Near-net-shaping, in which metals are cast into shapes that correspond closely to the final shape of the object, can reduce materials waste in some instances. Conventional processing generally involves considerable machining of billets, bars, or other standard precast shapes and generates substantial amounts of mill cuttings and machine scrap. In some cases, the ratio between purchased metal and used metal may be as high as 10 to 1.15. While much of this "new scrap" is reclaimed, some is contaminated and is unusable for high-performance applications like aircraft engines.

Improvements in production processes can also reduce metals needs. The use of manganese to desulfurize steel has been reduced with the intro-

¹³Office of Technology Assessment, *Strategic Materials: Technologies to Reduce U.S. Import Vulnerability*, p. 24.

duction of external desulfurization processes. Continuous casting technology can reduce the amount of scrap produced in steel manufacturing. Emerging technologies, for example, surface treatment technologies (e. g., ion-implantation) and powdered metal technologies, may also reduce the use of some metals for high-performance applications in the future.

For several metals, ' 'obsolete scrap' ('old scrap' could play an even more important role in reducing the need for virgin materials if economic conditions change and institutional problems are

overcome. Recycling and secondary production has become a stable sector for several of the minerals (e. g., copper, lead, zinc, nickel, silver, iron, steel, and to a lesser extent platinum, chromium, and cobalt). Very little manganese is recycled. Economic factors largely determine the recyclability of materials, factors such as price; cost of collecting, identifying, sorting, and separating scrap; and the cost of cleaning, processing, and refining the metal. It is technologically possible to recover significantly more chromium, cobalt, and platinum from scrap should the need arise and economics permit.

MAJOR SEABED MINERAL COMMODITIES

Cobalt

Properties and Uses

Cobalt imparts heat resistance, high strength, wear resistance, and magnetic properties to materials. In 1986, about 36 percent of the cobalt consumed in the United States was for aircraft engines and industrial gas turbines (superalloys contain from 1 to 65 percent cobalt); 14 percent was for magnetic alloys for permanent magnets; 13 percent for driers in paints and lacquers; 11 percent for catalysts; and 26 percent for various other applications. These other applications included using of cobalt to cement carbide abrasives in the manufacture of cutting tools and mining and drilling equipment; to bind steel to rubber in the manufacture of radial tires; as a hydrators, desulfurizer, and oxidizer and as a synthesizer of hydrocarbons; in nutritional supplements; and in dental and medical supplies.

There are currently no acceptable substitutes or replacements for cobalt in high-temperature applications, although alternatives have been proposed. However, the possible substitutes are also strategic and critical metals such as nickel. While ceramics have potential for high-temperature applications, it will be some time in the future before they can be used extensively in jet engines or industrial gas turbines. Use of some cobalt-rich alloys could be reduced by substitution of ceramic or ceramic-coated automobile turbochargers, and there are possible replacements for cobalt in magnets.

National Importance

The United States imported 92 percent of the cobalt it consumed in 1986.¹⁶ Cobalt is considered to be a potentially vulnerable strategic material (table 3-1) and is a priority item in the National Defense Stockpile. The stockpile goal for cobalt is 42,700 tons, and the inventory is currently 26,590 tons of contained cobalt, or about 62 percent of the goal. Much of the stockpiled cobalt is of insufficient grade to be used for the production of high-performance metals, although it could be used to produce important chemical products and for magnets.¹⁷

No cobalt has been mined in the United States since 1971. Zaire supplied 40 percent of U.S. cobalt needs from 1982 to 1985, Zambia 16 percent, Canada 13 percent, Norway 6 percent, and various other sources 25 percent.¹⁸ In addition, about 600 tons of cobalt was recycled from purchased scrap in 1986, or approximately 8 percent of apparent consumption. There has been no domestic cobalt refinery capacity since the AMAX Nickel Refining Company closed its nickel-cobalt refinery at Port Nickel, Louisiana, (capacity of 2 million pounds of cobalt per year), although two firms use the facility to produce extra-fine cobalt powder from virgin and recycled material.

¹⁶W. Kirk, ' 'Cobalt, " *Mineral Commodity Summaries-1987* (Washington, DC: U.S. Bureau of Mines, 1987), p. 38.

¹⁷American Society for Metals, *Quality Assessment of National Defense Stockpile Cobalt Inventory* (Metals Park, OH: American Society for Metals, 1983), p. 40.

¹⁸Kirk, ' 'Cobalt, ' , *Mineral Commodity Summaries—1987*, p. 38.

With 56 percent of cobalt imports originating from Zaire and Zambia, which together produce almost 70 percent of the world's supply of cobalt, the U.S. supply of cobalt is concentrated in developing countries with uncertain political futures. For example, the invasion of Shaba Province in Zaire in 1977 and 1978 by anti-government guerrillas caused some concern about the impact of political instability on cobalt supply. Abrupt increases in market prices followed, driven more by market opportunists and fear of the consequences than from direct interdiction of cobalt supply. Mining and processing facilities were only briefly closed and the impact on Zaire's production capacity was negligible.¹⁹

Domestic Resources and Reserves

Cobalt is recovered as a byproduct of nickel, copper, and, to a much lesser extent, platinum. Economic deposits typically contain concentrations of between 0.1 and 2 percent cobalt. The U.S. reserve base is large (950,000 tons of contained cobalt), but there are currently no domestic reserves of cobalt. Domestic cobalt resources are estimated at about 1.4 million tons (contained cobalt).²⁰

The economics of cobalt recovery are linked more with the market price of the associated major metals (copper and nickel) than with the price of cobalt. It is necessary, therefore, that the major metals be economically recoverable to permit the recovery of cobalt as a byproduct. As a result, the price sensitivity of cobalt production is difficult to forecast. Depressed prices for the base metals reduce the economic feasibility of recovering cobalt.

Domestic land-based cobalt-bearing deposits are likely not to be mined until some time in the fu-

ture. However, in an emergency and with government support, they could produce a significant proportion of U.S. cobalt consumption for a short time.²¹ In addition, cobalt-rich manganese crusts in the Blake Plateau off the southeastern Atlantic coast and crusts or pavements on seamounts in the Pacific Ocean contain cobalt concentrations of between 0.3 and 1.6 percent (some ferromanganese crust samples have been reported to contain up to 2.5 percent), along with nickel, manganese, and other metals. These compare favorably with U.S. land-based resources that range from 0.01 to about 0.55 percent cobalt.²²

Future Demand and Technological Trends

U.S. consumption generally accounts for about 35 percent of total world consumption. There is little prospect for major reductions in cobalt demand through substitution. Total U.S. demand for cobalt in 2000 is forecast to be between 24 million and 44 million pounds, with a probable demand of 34 million pounds (table 3-2).²³ Future demand for cobalt is difficult to forecast. Both the intensity of cobalt use and the amount of cobalt-based materials consumed have changed abruptly in the past and will likely continue to change in the future.

Chromium

Properties and Uses

Chromium is used in iron and steel, nonferrous metals, metal plating, pigments, leather process-

²¹G. Peterson, D. Bleiwas, and P. Thomas, *Cobalt Availability—Domestic*, IC 8849 (Washington, DC: U.S. Bureau of Mines, 1981), p. 27.

²²C. M. Ishiyama, C. Sheng-Fogg, R. Christensen, et al., *Cobalt Availability—Market Economy Countries*, IC 9012 (Washington, DC: U.S. Bureau of Mines, 1985), p. 10.

²³W. Kirk, "Cobalt," *Mineral Facts and Problems—1985 Edition*, Bulletin 675 (Washington, DC: U.S. Bureau of Mines, 1986), p. 180.

Table 3-2.—Forecast of U.S. and World Cobalt Demand in 2000

	Actual	2000			Annual growth 1983-2000 (percent)
		Low	Probable	High	
United States.	15,000a	24,000	34,000	44,000	3.9
Rest of world.	31,500	50,000	65,000	75,000	3.5
Total world.	—	74,000	99,000	120,000	3.7

a U.S. data for 1986 from W. Kirk, "Cobalt," *Mineral Commodity Summaries—1987* (Washington, DC: U.S. Bureau of Mines, 1987), p. 38.

SOURCE: Adapted from W. Kirk, "Cobalt," *Mineral Facts and Problems—1985 Edition*, Bulletin 675 (Washington, DC: U.S. Bureau of Mines, 1986), p. 182.

ing, catalysts, and refractories. In 1986, 88 percent of the chromite (common ore form of chromium) consumed in the United States was used by the metallurgical and chemical industry, and 12 percent by the refractory industry.

Metallurgical Uses.—Chromium is used in a variety of alloy steels, cast irons, and nonferrous alloys. Chromium is used in these applications to improve hardness, reduce creep, enhance impact strength, resist corrosion, reduce high-temperature oxidation, improve wear, or reduce galling.

High-carbon ferrochromium contains between 52 and 72 percent chromium and between 6 and 9.5 percent carbon. Low-carbon ferrochromium contains between 60 and 75 percent chromium and between 0.01 and 0.75 percent carbon. Ferrochromium-silicon contains between 38 and 45 percent silicon and between 34 and 42 percent chromium.

The largest amount of ferrochromium (76 percent in 1986) is used for stainless steels. Chromium is also used in nonferrous alloys and is essential in the so-called "superalloys" used in jet engines and industrial gas turbines. In 1984, about 3 percent of the ferrochromium and pure chromium metal used for metallurgy was for superalloys; less than 1 percent was used for other nonferrous alloys. Chromium, along with cobalt, nickel, aluminum, titanium, and minor alloying metals, enables superalloy to withstand high mechanical and thermal stress and to resist oxidation and hot corrosion at high operating temperatures.

Chemical Uses.—Chromium-containing chemicals include color pigments, corrosion inhibitors, drilling mud additives, catalysts, etchers, and tanning compounds. Sodium bichromate is the primary intermediate product from which other chromium-containing compounds are produced.

Refractory Uses.—Chromite is used to produce refractory brick and mortar. The major use for refractory brick is for metallurgical furnaces, glass-making, and cement processing. Use of chromite in refractories improves structural strength and dimensional stability at high temperatures.

National Importance

Chromium is considered to be a strategic material that is critical to national security and poten-

table 3-3.—1986 National Defense Chromium Stockpile Goals and Inventories (as of Sept. 30, 1986)

Material	Goal	Inventory as	
		Inventory	percent of goal
		(thousand tons)	
Chromite:			
Metallurgical	3,200	1,874	59
Chemical	675	242	36
Refractory	850	391	46
Ferrochromium:			
High-carbon	185	502	271
Low-carbon	75	300	400
Silicon	90	57	63
Chromium metal	20	4	20

SOURCE J Papp, "Chromium," *Mineral Commodity Summaries—1987* (Washington, DC: U.S. Bureau of Mines, 1987), p. 35.

tially very vulnerable to supply interruptions²⁴ (table 3-1 and 3-3). It is critical because of limitations on substitutes for chromium in the vacuum-melted superalloys needed for hot corrosion and oxidation resistance in high-temperature applications and in its extensive use in stainless steels.

The Republic of South Africa accounted for 59 percent of total chromium imports (chromite ore, concentrates, and ferroalloys) between 1982 and 1985. Other suppliers included Zimbabwe, which provided 11 percent, Turkey 7 percent, and Yugoslavia 5 percent.²⁵ The Republic of South Africa and the U.S.S.R jointly led in world production of chromite in 1986, producing about 3.7 and 3.3 million tons respectively, far ahead of the next largest producer, Albania, with about 1 million tons.²⁶ Some foreign producing countries, such as Brazil, are producing and exporting ferrochromium from chromite deposits which would not be competitive in the world market if shipped as ore or concentrate. However, by adding the value of conversion to ferroalloy, both the Brazilian and the Zimbabwe deposits remain competitive.

Domestic Resources and Reserves

The United States currently has no chromite *reserves* or *reserve base*. Domestic resources have been mined sporadically when prices are high, or

²⁴L+ Office of Technology Assessment, *Strategic Materials: Technologies to Reduce U.S. Import Vulnerability*, p. 52.

²⁵J. Papp, "Chromium," *Mineral Facts and Problems—1985 Edition*, Bulletin 675 (Washington, DC: U.S. Bureau of Mines, 1986), p. 141.

²⁶J. Papp, "Chromium," *Minerals Yearbook* (Washington DC: U.S. Bureau of Mines, 1985), p. 229.

with the aid of government price supports, or in times of national emergencies. Under normal economic conditions of world trade, U.S. chromite resources are not competitive with foreign sources of supply. There are 43 known domestic deposits estimated to contain approximately 7 million tons of contained chromic oxide as *demonstrated* resources and 25 million tons as identified resources.²⁷ U.S. chromite deposits range between 0.4 percent and 25.8 percent chromic oxide content.

The major known domestic deposits of chromite minerals are the stratiform deposits in the Stillwater Complex in Montana and in small podiform-type deposits in northern California, southern Oregon, and southern Alaska. Placer chromite deposits occur in beach sands in southwest Oregon and stream sands in Georgia, North Carolina, and Pennsylvania.

Although 91 percent of U.S. *demonstrated* chromite resources and 84 percent of identified resources could be converted as low-chromium ferrochromium, the U.S. Bureau of Mines doubts that domestic chromite resources could be produced economically even with much higher market prices than the current \$470 per ton for low-chromium ferrochromium and \$600 per ton for high-chromium ferrochromium. Most low-chrome ferrochromium could be produced domestically for a little less than about \$730 per ton, and high-chrome ferrochromium would cost even more.²⁸

With enormous reserves of all grades of chromite in other parts of the world, it is doubtful that the meager chromite resources of the United States could justify the investment needed to rebuild the domestic ferrochromium production capacity that has been lost. In addition, there is currently significant overcapacity in the ferrochromium industry in the market economy countries. Estimates in 1986 showed production capacity of 2.6 million tons compared to demand of 1.9 million tons.²⁹ There have been no significant shortages of ferrochromium encountered in world markets in the past to indicate that things might change in the future.

²⁷J. Lemons, Jr., E. Boyle, Jr., and C. Kilgore, *Chromium Availability—Domestic*, IC 8895 (Washington, DC: U.S. Bureau of Mines, 1982), p. 4.

²⁸*Ibid.*, p. 9.

²⁹W. Dresler, "A Feasibility Study of Ferrochromium Extraction from Bird River Concentrates in a Submerged-Arc Furnace," *CIM Bulletin*, vol. 79 (September 1986), pp. 98-105.

Domestic Production

The United States was the world's leading chromite producer in the 1800s, but, since 1900, seldom more than 1,000 tons have been produced annually except for periods of wartime emergencies. During both World Wars and the Korean War, production increased when the Federal Government subsidized domestic chromite production. Domestic production ceased in 1961 when the last purchase contract under the Defense Production Act terminated. Since then, there was one attempt to reopen a mine closed in the 1950s, but, after producing only a small amount of chromite for export in 1976, the mine was again abandoned. There has been no domestic production reported since.

The United States imported and consumed about 512,000 tons of chromite ore and concentrate in 1984, primarily for use in chemicals and refractories. In 1973, the United States ferrochromium capacity was about 400,000 tons (contained chromium); by 1984, domestic capacity had shrunk to about 187,000 tons—a decrease of about 54 percent.³⁰ U.S. capacity is expected to shrink further, to perhaps 150,000 tons by 1990.³¹ Ferrochromium production in 1984 was about 51,000 tons (contained chromium), or approximately 27 percent utilization of installed capacity.³² Production in 1984 was nearly four times that of 1983 as a result of government contracts for the conversion of stockpiled chromite to ferrochromium for the National Defense Stockpile. Once upgrading of the stockpile is completed, ferrochromium production may return to levels at or below 1983 production (13,000 tons—contained chromium). In 1984, only two of the six domestic ferrochromium firms were operating plants, and those only at low production levels or intermittently.

Future Demand and Technological Trends

Commodity analysts differ on the outlook for future chromium demand. One U.S. Bureau of

³⁰G. Guenther, "Ferroalloys," *The Competitiveness of American Metal Mining and Processing*, ch. VIII (Washington, DC: Congressional Research Service, 1986), p. 127.

³¹Papp, 'Chromium,' *Mineral Facts and Problems—1985 Edition*, p. 141.

³²Papp, 'Chromium,' *Minerals Yearbook—1984*, p. 220.

Table 3-4.—Forecasts for U.S. Chromium Demand in 2000
(thousand tons of contained chromium)

End use	1983	2000		
		Low	Probable	High
Chemical	62	90	110	121
Refractory	20	27	35	47
Fabricated metal products	21	60	80	100
Machinery	18	75	100	130
Transportation	39	80	100	130
Other	169	300	390	500

SOURCE: J. Papp, "Chromium," *Mineral Facts and Problems—1965 Edition*, Bulletin 675 (Washington, DC: U. S. Bureau of Mines, 1986), p. 152

Mines report foresees an increase in domestic chromium demand at a rate of about 6.5 percent per year between 1983 and 2000 (table 3-4),³³ from approximately 329,000 tons in 1983 to between 632,000 tons and about one million tons by 2000, with the most probable estimate being 815,000 tons. About 83 percent of the probable estimated demand in 2000 is expected to be used in metals; 13 percent in chemicals; and 4 percent in refractories.

Based on trends in chromium consumption and use, another Bureau of Mines report, produced in cooperation with basic industry analysts of the Department of Commerce, foresees a different demand scenario. This scenario is based on the theory that demand for ferrochromium is largely determined by the demand for stainless steel. Domestic production of stainless steel has remained relatively stable since 1980 at between 1.7 million and 1.8 million tons per year, with the exception of 1982 when it dipped to 1.2 million tons. Although chromium content of specific alloy and stainless steels remains stable, the use of high-chromium content steels has decreased in volume.³⁴

There is significant potential for reducing the consumption of chromium through substitution by low-chromium steels, titanium, or plastics for stainless steel in less-demanding applications. The National Materials Advisory Board (NMAB) determined that 60 percent of the chromium used in stainless steel could be saved in a supply emergency by the use of low-chromium substitutes or no-chromium materials that either currently exist or could be developed within 10 years.³⁵ Only 20 to 30 per-

cent of the chromium currently used domestically in stainless steel is considered to be irreplaceable. Substitution may also displace some of the chromite used in refractories with the use of low-chromite bricks or dolomite bricks. Substitutes for chromium in pigments and plating are also available, although at some sacrifice in desirable properties.

Use of chromium in chemicals generally reflects a slow but steady growth in chromium consumption, with expanded capacity of the chemical industry offsetting a decrease in the intensity of use of chromium. The use of chromite-containing refractories has significantly declined as the result of technological improvements in steel furnaces; open hearth furnaces have given way to electric arc furnaces and basic oxygen furnaces (BOF) in the steelmaking process. As a result of these changes in the intensity of use of chromium, the combined Bureau of Mines and Department of Commerce report forecasts a reduction in chromium demand from about 330,000 tons in 1983 to 275,000 tons in 1993.³⁶

New technology for processing chromite ores has also increased the world supply of usable chromite reserves. Improvements in technologies to recover chromium from laterite deposits may also make low-grade deposits, some located in the western United States, more desirable for chromium recovery, but probably still not competitive.³⁷

mium Utilization, NMAB-335 (Washington, DC: National Academy of Sciences, 1978).

³⁶Ibid., p. 44.

³⁷A. Silverman, J. Schmidt, P. Queneau, et al., *Strategic and Critical Mineral Position of the United States with Respect to Chromium, Nickel, Cobalt, Manganese, and Platinum*, OTA Contract Report (Washington, DC: Office of Technology Assessment, 1983), p. 133; see also, H. Salisbury, M. Wouden, and M. Shirts, *Beneficiation of Low-Grade California Chromite Ores, RI 8592* (Washington, DC: U.S. Bureau of Mines, 1982), p. 15.

³³Papp, "Chromium," *Mineral Facts and Problems—1985*, p. 152.

³⁴*Domestic Consumption Trends, 1972-82, and Forecasts to 1993 for Twelve Major Metals*, Open File Report 27-86 (Washington DC: U.S. Bureau of Mines, 1986), p. 7.

³⁵National Materials Advisory Board, *Contingency Plans for Chro-*

Manganese

Properties and Uses

Manganese plays a major role in the production of steels and cast iron. Originally, manganese was used to control oxygen and sulfur impurities in steel. As an alloying element, it increases the strength, toughness, and hardness of steel and inhibits the formation of carbides which could cause brittleness. Manganese is also an important alloying element for nonferrous materials, including aluminum and copper.

Hadfield steels containing between 10 and 14 percent manganese, are wear-resistant alloys used for certain railroad trackage and for mining and crushing equipment. An intermediate form of manganese alloy—ferromanganese—is usually used in the manufacture of steels, alloys, and castings. Because manganese can exist in several chemical oxidation states, it is used in batteries and for chemicals. Several forms of manganese are used in the manufacture of welding-rod coatings and fluxes and for coloring bricks and ceramics.

National Importance

Demand for manganese is closely related to steel production. Two major trends have combined to lessen domestic consumption of manganese. First, domestic steel production has declined; in 1986, it was at about half of its peak year in 1973, when the U.S. produced 151 million tons of raw steel. Second, developments in steel manufacturing technology have reduced the per-unit quantities of manganese needed. As a result, manganese consumption decreased from 1.5 million tons (contained manganese) in 1973 to 700,000 tons in 1986.

In the early 1970s, the United States was importing about 70 percent of its manganese in the form of ores, a large share of which was processed into ferromanganese by U.S. producers. By 1979, the picture had reversed, with imports of foreign-produced ferromanganese running at about 70 percent and manganese ores at about 30 percent. Since 1983, imports have been about one-third as ore and two-thirds as ferromanganese and metal (figure 3-5). There currently is no remaining domestic capacity for ferromanganese production.

Figure 3-5.—Percentage of Manganese imported into the United States as Ferromanganese, 1973=86

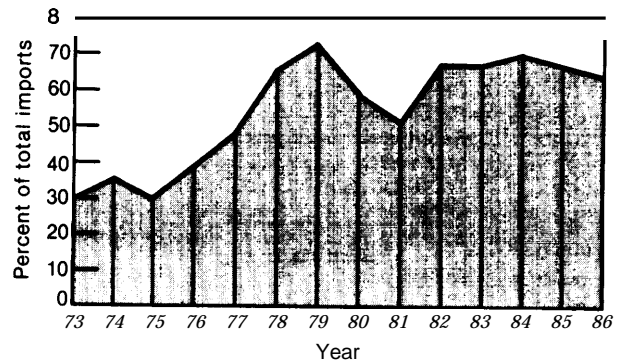

Like chromium and ferrochromium, the proportion of manganese imported by the United States as ferromanganese and manganese metal has increased compared to imported manganese ore. Manganese producing countries find it advantageous to ship processed ferromanganese or metal rather than unprocessed ore to gain the value added for export.

SOURCE: Office of Technology Assessment, 1987.

Today, the United States is highly dependent on foreign sources for manganese concentrates, ores, ferromanganese, and manganese metal. About 30 percent of the imports (based on contained manganese) are from the Republic of South Africa, 16 percent from France (produced largely from ore imported from Gabon), 12 percent from Brazil, 10 percent from Gabon, and 32 percent from diverse other sources.³⁸

Manganese is a strategic material which is critical to national security and is potentially vulnerable to supply interruptions (table 3-1). Several forms of manganese are stockpiled in the National Defense Stockpile (table 3-5). However, the diversification of imports among many producing countries tends to somewhat reduce U.S. vulnerability to supply interruptions, although some supplier nations obtain raw material from less-secure African sources.

Domestic Resources and Reserves

Manganese pavements and nodules (approximately 15 percent manganese) on the Blake Plateau in the U.S. EEZ off the southeast coast are

³⁸T. Jones, "Manganese," *Mineral Commodity Summaries-1987* (Washington, DC: U.S. Bureau of Mines, 1987), p. 98.

Table 3-5.—Status of Manganese in the National Defense Stockpile—1986 (as of Sept. 30, 1986)

Material	Inventory as	
	Goal	percent of goal
	(thousand tons)	
Battery grade.	87	175
Chemical ore	170	172
Metallurgical ore.	2,700	2,235 ^a
Ferromanganese	439	700
Silicomanganese	0	24
Electrolytic metal	0	14

^aStockpiled metallurgical grade ore is being converted to high-carbon ferromanganese which will add about 472,000 tons of ferromanganese to the stockpile and reduces the amount of manganese ore.

SOURCE: T Jones, "Manganese," *Mineral Commodity Summaries—1987* (Washington, DC: U.S. Bureau of Mines, 1987), p. 99.

estimated to contain as much as 41 million tons of manganese. Similar deposits off Hawaii and the Pacific Islands represent even more manganese on the seafloor within the U.S. EEZ.³⁹

At current prices, there are no *reserves* of manganese ore in the continental United States that contain 35 percent or more manganese, nor are there resources from which concentrates of that grade could be economically produced. The 70 million tons of contained manganese *resources* estimated to exist in the United States average less than 20 percent and generally contain less than 10 percent manganese. The U.S. Bureau of Mines estimates that the domestic land-based subeconomic resources would require from 5 to 20 times the current world price of manganese to become commercially viable.⁴⁰

Should an emergency require that economically submarginal domestic deposits be brought into production, the most likely would be in the north Aroostook district of Maine and the Cuyuna north range in Minnesota.⁴¹

It is unlikely that there will be much improvement in the U.S. manganese supply position. Past efforts to discover rich ore bodies or to improve the efficiency of processing technology have not been successful. What is known about seabed resources

³⁹F. Manheim, "Marine Cobalt Resources," *Science*, vol.232, May 2, 1986, Pp. 600-608.

⁴⁰T. Jones, "Manganese," *Mineral Facts and Problems—1985 Edition*, Bulletin 675 (Washington, DC: U.S. Bureau of Mines, 1986), p. 486.

⁴¹National Materials Advisor, Board, *Manganese Recovery Technology*, N MAB-323 (Washington, DC: National Academy of Sciences, 1976).

of manganese pavement and nodules indicates that manganese content may range between 15 and 30 percent, which makes offshore deposits at least comparable with some onshore deposits. But the uncertainties of offshore mining ventures and their associated costs, coupled with marginal mineral prices, raise doubts as to their economic feasibility as well.⁴²

Future Demand and Technological Trends

Future manganese consumption will be determined mainly by requirements for steelmaking. The amount of manganese required for steelmaking depends on two factors: 1) the quantity of manganese used per ton of steel produced, and 2) the total amount of steel produced in the United States. Comparing 1982 with 1977, the intensity of use of manganese in the steel sector was reduced by half, and the total consumption of manganese used for producing steel also dropped around 50 percent.⁴³

Although there has been a trend toward the use of higher manganese contents for alloying in high-strength steels and steels needed for cryogenic applications, the reduction in the intensity of use for steels used in large volumes has far exceeded the increases for the high-performance steels. Because manganese is an inexpensive commodity, there is little incentive to develop conservation technologies further.

The U.S. Bureau of Mines expects domestic manganese demand in 2000 to range between 700,000 and 1.3 million tons (manganese content), with probable demand placed at 900,000 tons (table 3-6). With 1986 apparent consumption about 665 million tons, only modest growth in demand is expected through the end of the century.

Nickel

Properties and Uses

Nickel imparts strength, hardness, and corrosion resistance over a wide range of temperatures when

⁴²C. Hillman, *Manganese Nodule Resources of Three Areas in the Northeast Pacific Ocean: With Proposed Mining-Beneficiation Systems and Costs*, IC8933 (Washington, DC: U.S. Bureau of Mines, 1983).

⁴³Domestic Consumption *Trends, 1972-82, and Forecasts to 1993 for Twelve Major Metals*, Open File Report 27-86 (Washington, DC: U.S. Bureau of Mines, 1986), p. 77.

Table 3-6.—Forecast for U.S. and World Manganese Demand in 2000

	Actual	2000			Annual growth 1983-2000 (percent)
		Low	Probable (thousand tons)	High	
United States.	665 ^a	660	920	1,260	1.9
Rest of world.	8,132	8,200	10,200	13,900	1.3
Total world.	—	8,900	11,100	15,200	1.4

^aU.S. data for 1988 from T. Jones, "Manganese," *Mineral Commodity Summaries—1987* (Washington, DC: U.S. Bureau of Mines, 1987), p. 98.

SOURCE: Adapted from T. Jones, "Manganese," in *Mineral Facts and Problems—1985 Edition* (Washington, DC: U.S. Bureau of Mines, 1988), p. 495

alloyed with other metals. Approximately 39 percent of the primary nickel consumed in the United States in 1986 went into stainless and alloy steels; 31 percent was used in nonferrous alloys; and 22 percent was used for electroplating. The remaining 8 percent was used in chemicals, batteries, dyes and pigments, and insecticides.

Stainless steels may contain between 1.25 percent and 37 percent nickel, although the average is about 6 percent. Alloy steels, such as those used for high-strength components in heavy equipment and aircraft operations, contain about 2 percent nickel, although the average is less than 1 percent, while superalloy used for very high-temperature and high-stress applications like jet engines and industrial turbines may contain nearly 60 percent nickel. Nickel also is used in a wide range of other alloys (e. g., nickel-copper, copper-nickel, nickel-silver, nickel-molybdenum, and bronze).

National Importance

Most uses for nickel are considered critical for national defense and are generally important to the U.S. industrial economy overall. However, based on criteria that consider supply vulnerability and possible substitute materials, OTA determined in a 1985 assessment that nickel, while economically important, is not a *major "strategic" material*.⁴⁴ Nickel is stockpiled in the National Defense Stockpile. The stockpile goal is 200,000 tons of contained nickel, and the inventory in 1986 was 37,200 tons—about 20 percent of the goal.

The United States imported about 78 percent of the nickel consumed in 1986.⁴⁵ Canada was the major supplier of nickel (40 percent) to the United

⁴⁴Office of Technology Assessment, *Strategic Materials: Technologies to Reduce U.S. Import Vulnerability*, p. 52.

⁴⁵P. Chamberlain, "Nickel," *Mineral Commodity Summaries—1987* (Washington, DC: U.S. Bureau of Mines, 1987), p. 108.

States; Australia provided 14 percent, Norway 11 percent, Botswana 10 percent, and 25 percent was obtained from other countries, including the Republic of South Africa, New Caledonia, Dominican Republic, Colombia, and Finland. In 1986, the United States consumed 184,000 tons of nickel, compared to 283,000 tons in 1974.

Domestic Resources and Reserves

Domestically produced nickel will probably continue to be a very small part of U.S. total supply in the future. U.S. *demonstrated* resources are estimated to be about 9 million tons of nickel in place, from which 5.3 million tons may be recoverable.⁴⁶ *Identified* nickel resources are about 9.9 million tons, which could yield 6 million tons of metal. The domestic *reserve base* is estimated to be 2.8 million tons of contained nickel.⁴⁷ Although U.S. resources are substantial, the average grade of domestic nickel resources is about 0.21 percent (ranging from 0.16 percent to 0.91 percent), compared to the average world grade of nearly 0.98 percent. Ferromanganese crusts on Pacific Ocean seamounts are reported to be about 0.49 percent nickel.⁴⁸

Domestic Production

Nickel production from U.S. mines was 1,100 tons in 1986, with about 900 tons of nickel recovered as a nickel sulfate byproduct of two primary

⁴⁶D. Buckingham and J. Lemons, Jr., *Nickel Availability - Domestic*, IC 8988 (Washington, DC: U.S. Bureau of Mines, 1984), p. 25.

⁴⁷Chamberlain, "Nickel," *Mineral Commodity Summaries—1987*, p. 109.

⁴⁸W. Harvey and P. Ammann, "Metallurgical Processing Component for the Mining Development Scenario for Cobalt-Rich Ferromanganese Oxide Crust, Final Draft Chapter, *Manganese Crust EIS Project* (Arlington, MA: Arlington Technical Services, 1985), pp. 3-2

copper operations.⁴⁹ The only domestic mine to metal production came from Hanna Mining Company's Nickel Mountain Mine in Oregon, which produced ferronickel; the mine closed permanently in August 1986. Secondary recovery of nickel from recycled old and new scrap contributed about 39,000 tons in 1986, which was approximately 21 percent of apparent consumption.

Future Demand and Technological Trends

After growing at an average rate of roughly 6 percent per year for most of the century, nickel consumption flattened in the 1970s. From 1978 to 1982, the consumption sharply declined before stabilizing in the mid-1980s. A major factor in the declining consumption between 1978 and 1982 was the drop in the intensity of nickel use. Less nickel was used per value of Gross National Product and per capita each year during the period. Since 1982, the intensity of use has remained fairly constant.

Much of the decrease in the intensity of use resulted from the substitution of plastics in coatings, containers, automobile parts, and plumbing, and displacement in the use of some stainless steel. Other possible substitute materials include aluminum, coated steel, titanium, platinum, cobalt, and copper. These substitutes, however, can mean poorer performance or added cost. Higher imports of finished goods and the reduced size of automobiles also reduce domestic nickel demand.

Domestic demand for nickel in 2000 is forecast to be between 300,000 and 400,000 tons, with the probable level being about 350,000 tons (table 3-7).⁵⁰ The forecast for a 2.6 percent annual growth

in domestic nickel demand through 2000 is due to projected growth in total consumption, primarily for pollution abatement and waste treatment machinery, mass transit systems, and aerospace components.⁵¹

Copper

Properties and Uses

Copper offers very high electrical and thermal conductivity, strength, and wear- and corrosion-resistance, and it is nonmagnetic. As a result, copper is valuable both as a basic metal and in alloys (e.g., brass, bronze, copper nickel, copper-nickel-zinc-alloy, and leaded copper), and ranks third in world metal consumption after steel and aluminum. About 43 percent of U.S. copper products are used in building construction, 24 percent in electrical and electronic products, 13 percent for industrial machinery and equipment, 10 percent in transportation, and the remaining 10 percent in general products manufacturing.

In the aggregate, the largest use of copper (65 percent) is in electrical equipment, in the transmission of electrical energy, in electronic and computing equipment, and in telecommunications systems. Because of its corrosion resistance, copper has many uses in industrial equipment and marine and aircraft products. Copper is used extensively for plumbing, roofing, gutters, and other construction purposes. Brass is used in ordnance, military equipment, and machine tools that are important to national security. Copper chemicals are also used in agriculture, in medicine, and as wood preservatives. Once used extensively in coinage, copper has been

⁴⁹Chamberlain, "Nickel," *Mineral Commodity Summaries-1987*, p. 109.

⁵⁰S. Sibley, "Nickel," *Mineral Facts and Problems—1985 Edition*, Bulletin 675 (Washington, DC: U.S. Bureau of Mines, 1986), p. 547.

⁵¹International Trade Administration, *The End-Use Market for 13 Non-Ferrous Metals* (Washington, DC: U.S. Department of Commerce, 1986), p. 32.

Table 3-7.— Forecast of U.S. and World Nickel Demand in 2000

	Actual	2000			Annual growth 1983-2000 (percent)
		Low	Probable	High	
United States.	184a	300	350	400	2.6
Rest of world.	800	1,000	1,300	1,500	2.9
Total world.	—	1,300	1,700	1,900	2.7

aU, S. data for 1986 from P. Chamberlain, "Nickel," *Mineral Commodity Summaries—1987 Edition* (Washington, DC: U.S. Bureau of Mines, 1987), p. 108.

SOURCE Adapted from S. Sibley, "Nickel," *Mineral Facts and Problems—1985 Edition* (Washington, DC: U.S. Bureau of Mines, 1986), p. 548.

largely replaced by zinc and zinc-copper alloys in U.S. currency.

National Importance

Copper is a strategic commodity in the National Defense Stockpile. The stockpile goal is one million tons, with an inventory of 22,000 tons in 1986. The United States is the leading consumer of refined copper; it accounted for about 29 percent of world consumption, or 2.2 million tons of copper, in 1986. In 1982 the United States import reliance was 1 percent of the copper it consumed; by 1985, it was importing 28 percent.⁵² Imports came largely from North and South America: Chile, 40 percent; Canada, 29 percent; Peru, 8 percent; Mexico, 2 percent. Other sources were: Zambia, 7 percent; Zaire, 6 percent; and elsewhere, 8 percent. Since 1982, Chile has led the world in copper production, followed by the United States, Canada, U. S. S. R., Zambia, and Zaire,

Domestic Resources and Reserves

World copper reserves total about 375 million tons, with 80 percent residing in market economy countries. The world's reserve base is about 624 million tons of copper, Chile has the largest single share of world reserves, accounting for 23 percent; the United States is second with 17 percent.⁵³

The United States has a reserve base of about 99 million tons of copper, with reserves of 63 million tons. The average grade of domestic copper ore is about 0.5 percent copper, while the world average is close to 0.87 percent.⁵⁴ By comparison, copper in some polymetallic sulfide deposits that have been recovered from the seafloor show high variability ranging between 0.5 to 5 percent.⁵⁵

Domestic Production

The United States mined 1.2 million tons of copper in 1986—second only to Chile in world mine production. Domestic mine production peaked in

1970, 1973, and 1981 at about 1.7 million tons each year, but then in response to depressed prices and a worldwide recession, production was cut back. Since then, copper production has recovered slowly to roughly the 1980 level. Copper's recent recovery has benefited from industry-wide cost cutting and improvements in efficiency and productivity resulting from equipment modernizations and re-negotiated labor agreements.

The United States is one of the world's largest producers of refined copper, accounting for about 16 percent of world production in 1985. Copper is one of the most extensively recycled of all the common metals. Nearly 22 percent of domestic apparent consumption is recycled from old scrap. Copper prices peaked in 1980 at about \$1.00 per pound (current dollars) as a result of high demand and industry labor disruptions, but have since sunk to nearly \$0.62 (current dollars) in 1986. With lower prices, there is little incentive to increase efforts to recycle used copper.

Notwithstanding the large reserve base of copper in the United States, lower-cost imported copper has displaced appreciable domestic production in recent years. During 1984-85, domestic copper refinery capacity was reduced by about 410,000 tons, and several major mines closed. Between 1974 and 1985, domestic operating refinery capacity declined from 3.4 million tons to about 2 million tons as the result of major industry restructuring and cost reduction.

A number of factors have contributed to the disadvantage that U.S. producers face in meeting foreign competition, e.g., lower ore grade, higher labor costs, and more stringent environmental regulations and until recently, foreign exchange rates. Although significant progress recently has been made by U.S. copper producers to increase productivity and reduce costs at the mine and smelter, there is some doubt whether domestic producers can maintain their market position in the long term.⁵⁶

Future Demand and Technological Trends

Since 1981, worldwide copper production has increased significantly while the rate of demand

⁵²J. Jolly and D. Edelstein, "Copper," *Mineral Commodity Summaries—1987* (Washington, DC: U.S. Bureau of Mines, 1987), p. 42.

⁵³J. Jolly, "Copper," *Mineral Facts and Problems—1985 Edition*, Bulletin 675 (Washington, DC: U.S. Bureau of Mines, 1986), p. 203.

⁵⁴L. Sousa, *The U.S. Copper Industry* (Washington, DC: U.S. Bureau of Mines, 1981), p. 27.

⁵⁵V. McKelvey, *Subsea Mineral Resources*, Bulletin 1689-A (Washington, DC: U.S. Geological Survey, 1986), p. 82.

⁵⁶Commodities Research Unit, *Copper Studies*, vol. 14, No. 4 (New York, NY: CRV Consultants, 1986), p. 7.

growth has been moderated largely by economic conditions and, to a lesser extent, by reduction in the intensity of copper use and substitution of other materials. Thus, today there is the possibility of substantial excess mine capacity in the world copper industry. Overly optimistic forecasts of demand based on consumption trends made in the late 1960s and early 1970s, forecasts of higher real prices, and the unforeseen onset of worldwide recessions beginning in 1975 and 1981 contributed to excess copper production.

The U.S. Bureau of Mines forecasts that domestic demand will increase to between 2.6 tons and 4.5 million tons by 2000, with probable demand about 3.1 million tons of copper (table 3-8). U.S. demand is forecast to increase at an annual rate of approximately 1.9 percent, while the rest of the world is expected to expand copper use at the higher rate of 2.9 percent.

The intensity of copper use fell by about one-fourth between 1970 and 1980.⁵⁷ Reductions in use were caused by the reduction in size of automotive and consumer goods, changes in design to conserve materials or increase efficiency, and substitutions of aluminum, plastics, and, to a lesser extent, optical fibers. Although the decline in the intensity of copper use is not expected to continue at the 1970s' rate and even could be offset by gains in other areas, the future of copper demand is uncertain. Moreover, copper is an industrial metal, and its consumption is linked to industrial activity and capital expansion. This makes copper demand very sensitive to general economic activity.

⁵⁷Domestic Consumption Trends, 1972-82, and Forecasts to 1993 for Twelve Major Metals, p. 60.

Zinc

Properties and Uses

Zinc is the third most widely used nonferrous metal, exceeded only by aluminum and copper. It is used for galvanizing (coating) steel, for many zinc-based alloys, and for die castings. Zinc is also used in industrial chemicals, agricultural chemicals, rubber, and paint pigments. Construction materials account for about 45 percent of the slab zinc consumed in the United States; transportation accounts for 25 percent; machinery, 10 percent; electrical, 10 percent; and other uses, 10 percent.

National Importance

During the last 15 to 20 years, the United States has gone from near self-sufficiency in zinc metal production to importing 74 percent of the zinc consumed domestically in 1986.⁵⁸ Zinc is a component of the National Defense Stockpile; the stockpile goal is 1.4 million tons and the inventory in 1986 was about 378,000 tons—27 percent of the goal.

The United States consumed about 1.1 million tons of zinc in 1986. Between 1972 and 1982, U.S. slab zinc consumption decreased by nearly half,⁵⁹ a dramatic drop attributable to the combined effects of the economic recession and a decline in the intensity of use of zinc in construction and manufacturing.

Zinc is imported as both metal and concentrates. Canada provides about half the zinc imported into the United States; Mexico provides 10 percent; Peru, 8 percent; and Australia, 4 percent. All of

⁵⁸J. Jolly, "Zinc," *Mineral Commodity Summaries—1987* (Washington, DC: U.S. Bureau of Mines, 1987), p. 180

⁵⁹Domestic Consumption Trends, 1972-82, and Forecasts to 1993 for Twelve Major Metals, p. 131.

Table 3-8.—U.S. and World Copper Demand in 2000

	Actual	2000			Annual growth 1983-2000 (percent)
		Low	Probable	High	
United States	2,390 ^a	2,600	3,100	3,900	1.9
Rest of world	8,300	11,700	13,400	15,000	2.9
Total world	—	14,300	16,500	18,800	2.7

^aU.S. data for 1986, J. Jolly, and D. Edelstein, "Copper," *Mineral Commodity Summaries—1987* (Washington, DC: U.S. Bureau of Mines, 1987), p. 42, world data for 1983 from source below

SOURCE Adapted from J. Jolly, "Copper," *Mineral Facts and Problems—1985 Edition* (Washington, DC: Bureau of Mines, 1986), p. 219

the major foreign sources of supply are considered to be secure, and there is little risk of supply interruptions.

Domestic Resources and Reserves

The U.S. reserve *base is* estimated to be about 53 million tons of zinc. Domestic *reserves* are nearly 22 million tons. Zinc is generally associated with other minerals containing precious metals, lead, and/or copper. The world *reserve base is* estimated to be 300 million tons of zinc, with major deposits located in Canada, Australia, Peru, and Mexico. World zinc *resources* are estimated to be nearly 2 billion tons.⁶⁰ Zinc occurs in seabed polymetallic sulfide deposits along with numerous other metals. The few samples of sulfide material that have been recovered for analysis show wide ranges in zinc content (30-0.2 percent).⁶¹

Domestic Production

U.S. mine production of zinc in 1986 was about 209,000 tons, down from 485,000 tons in 1976. The decline is attributed to poor market conditions and depressed prices. Some mines shut down in 1986 are expected to reopen in 1987, and new mines will open. Production is then expected to return to around the 1985 level, or about 250,000 tons. Domestic zinc metal production in 1986 also reached lows comparable to those of the depression in the early 1930s. Recycling accounted for 413,000 tons of zinc—about 37 percent of domestic consumption—in 1986.

Future Demand and Technological Trends

The U.S. Bureau of Mines forecasts that both domestic and world zinc demand will increase at

the rate of about 2 percent annually through 2000. Probable U.S. demand in 2000 is forecast to be about 1.5 million tons, with possible demand ranging between a low of 1.1 million tons and a high of 2.3 million tons (table 3-9).

A major determinant of future zinc demand will be its use in the construction (galvanized metal structural members) and automotive industries, which together account for about 60 percent of zinc consumption in the U.S. Although use of zinc by the domestic automotive industry has decreased in recent years, this trend is expected to reverse, and manufacturers will again use more electro-galvanized, corrosion-resistant parts as a competitive strategy through extended warranty protection.

Aluminum, plastics, and magnesium can substitute for many zinc uses, including castings, protective coatings, and corrosion protection. Aluminum, magnesium, titanium, and zirconium compete with zinc for some chemical and pigment applications.

It is likely that the U.S. will continue to rely in part on foreign sources of supply; however, domestic resources in Alaska and perhaps Wisconsin might be developed to offset some imports.⁶² Secondary sources and recycling of zinc could become more important in the future with improvements in recycling technology and better market conditions.

Gold

Properties and Uses

Gold is a unique commodity because it is considered a measure and store of wealth. Jewelry and art accounted for 48 percent of its use in the United

⁶⁰J. Jolly, "Zinc," *Mineral Commodity Summaries—1987*, p. 181.
⁶¹McKelvey, *Subsea Mineral Resources*, p. 82.

⁶²Jolly, "Zinc, *Mineral Facts and Problems—1985 Edition*, Bulletin 675 (Washington, DC: U. S. Bureau of Mines, 1986), p. 939.

Table 3.9.—Forecast of U.S. and World Zinc Demand in 2000

	Actual	2000			Annual growth 1983-2000 (percent)
		Low	Probable	High	
United States	1,130a	1,100	1,540	2,310	2.0
Rest of world	6,340	7,490	8,820	10,250	2.0
Total	—	8,590	10,360	12,560	2.0

^aU.S. data for 1986 from J. Jolly, "zinc," *Mineral Commodity Summaries—1987* (Washington, DC: U.S. Bureau of Mines, 1987), p. 180, world data for 1983 from source below.

SOURCE: Adapted from J. Jolly, "Zinc," *Mineral Facts and Problems—1985 Edition* (Washington, DC: U.S. Bureau of Mines, 1988), p. 938.

States in 1986, Gold's resistance to corrosion makes it suitable for electronics uses and dentistry. Gold is also used in the aerospace industry in brazing alloys, in jet and rocket engines, and as a heat reflector on some components. Industrial and electronic applications accounted for about 35 percent of 1986 consumption, dental 16 percent, and investment bars about 1 percent of the gold consumed in 1986. Although gold is exchanged in the open market, about 1.2 billion troy ounces—one-third of the gold mined thus far in the world—is retained by governments.

National Importance

Gold is not a component of the National Defense Stockpile, but the U.S. Treasury keeps a residual stock of about 263 million troy ounces of bullion. Although gold is no longer linked directly to the U.S. monetary system, its value in the world economic equation continues to be a hedge against future economic uncertainties. Should the United States or other major countries return to a regulated gold standard, its price could be affected significantly. Recently the United States issued the Golden Eagle coin for sale as a collector's and investor's item, but gold is not normally circulated as currency.

Apparent U.S. consumption of gold was 3.3 million troy ounces in 1986, whereas about 3.6 million troy ounces were produced by U.S. mines.⁶³ When U.S. primary industrial gold demand peaked in 1972 at about 6.6 million troy ounces, imports relative to domestic production were about 71 percent. At the lowest primary demand level in 1980 (1 million troy ounces), net imports exceeded primary demand by nearly 2.6 million troy ounces.⁶⁴ Canada is the largest single source of imported gold.

Domestic Resources and Reserves

The United States gold reserve base is about 120 million troy ounces. Most of the *reserve base* is in lode deposits. The world *reserve base* of gold is about 1.5 billion ounces, of which about half is located in the Republic of South Africa.⁶⁵ Some off-

shore placer deposits, such as those currently being experimentally dredge mined by Inspiration Mines near Nome, Alaska, maybe considered part of the *reserve base*.

Domestic Production

Domestic gold production was at an all-time high in 1986 with about 3.6 million ounces mined. Lowest production within the last 10 years was 964,000 ounces in 1979. The Republic of South Africa produced about 21 million ounces of gold in 1986—over 40 percent of total world production. Compared to major gold mines in South Africa, the U. S. S. R., and Canada, most existing and potential U.S. gold mines are low-grade, short-life operations with annual outputs between 20,000 and 90,000 troy ounces.⁶⁶

Future Demand and Technological Trends

Generally, domestic primary demand for gold has decreased steadily since its peak at 6.3 million ounces in 1972. Nevertheless, the U.S. Bureau of Mines forecasts that domestic gold demand will increase at an average annual rate of about 2.4 percent through 2000. Domestic primary demand is forecast to be between a low of 2.8 million ounces and a high of 4.6 million ounces in 2000, with the probable demand at 3.7 million troy ounces.⁶⁷ Demand in the rest of the world is expected to grow at a slower pace of 1.7 percent annually through 2000.

While other metals may substitute for gold, substitution is generally done at some sacrifice in properties and performance. Platinum-group metals are occasionally substituted for gold but with increased costs and with metals considered to be critical and strategic. Silver may substitute in some instances at lower cost, but it is less corrosion-resistant and involves some compromise in performance and dependability.

⁶³J. Lucas, "Gold," *Mineral Commodity Summaries—1987* (Washington, DC: U. S. Bureau of Mines, 1987), p. 62.

⁶⁴J. Lucas, "Gold," *Mineral Facts and Problems—1985 Edition*, Bulletin 675 (Washington, DC: U.S. Bureau of Mines, 1986), p. 336.

⁶⁵Lucas, "Gold," *Mineral Commodity Summaries-1987*, p. 63.

⁶⁶P. Thomas and E. Boyle, Jr., *Gold Availability—World*, IC9070 (Washington DC: U.S. Bureau of Mines, 1986), p. 38.

⁶⁷Lucas, "Gold," *Mineral Facts and Problems—1985 Edition*, p. 335.

Platinum-Group Metals

Properties and Uses

The platinum-group metals (PGMs) consist of six closely related metals that commonly occur together in nature: platinum, palladium, rhodium, iridium, ruthenium, and osmium.⁶⁸ They are not abundant metals in the earth's crust; hence their value is correspondingly high. At one time, nearly all of the platinum metals were used for jewelry, art, or laboratory ware but during the last 30 or 40 years they have become indispensable to industry, which now consumes 97 percent of the PGMs used annually in the United States.

Industry uses PGMs for two primary purposes: 1) corrosion resistance in chemical, electrical, glass fiber, and dental-medical applications, and 2) a catalysis for chemical and petroleum refining and automotive emission control. About 46 percent of PGMs was used for the automotive industry in 1986, 18 percent for electronic applications, 18 percent for dental and medical uses, 7 percent for chemical production, and 14 percent for miscellaneous uses.⁶⁹ Although the importance of platinum for jewelry and art has diminished as industrial uses increase, a significant amount of the precious metal is retained as ingots, coins, or bars by investors.

While the PGMs are often referred to collectively for convenience, each has special properties. For example, platinum-palladium oxidation catalysts are used for control of auto emissions, but a small amount of rhodium is added to improve efficiency. Palladium is used in low-voltage electrical contacts, but ruthenium is often added to accommodate higher voltages.⁷⁰

National Importance

The United States is highly import-dependent for PGMs. About 98 percent of PGMs consumed in 1986 were imported. The Republic of South

Africa supplied 43 percent of U.S. consumption, United Kingdom 17 percent, U.S.S.R. 12 percent, and Canada, Colombia and other sources 28 percent. Because nearly all of the PGMs imported from the United Kingdom originated in South Africa prior to refining, the Republic of South Africa actually provides the United States with approximately 60 percent of its platinum imports.

Potential instability in southern Africa, dependence on the U.S.S.R. for a portion of U.S. supply, scarcity of domestic resources, and the importance that PGMs have assumed in industrial goods and processes make platinum metals a first tier critical and strategic material.⁷¹ Platinum, palladium, and iridium are retained in the National Defense Stockpile (table 3-10).

Domestic Resources and Reserves

There are several major areas with PGM deposits that are currently considered to be economic or subeconomic in the United States. The domestic reserve *base* is estimated to be about 16 million troy ounces.⁷² Of that, however, only 1 million ounces are considered to be *reserves*.⁷³ Most of the PGM reserves are byproduct components of copper reserves. *Demonstrated* resources may contain 3 million ounces of platinum of which 2 million ounces are gauged to be recoverable.⁷⁴ Some estimates place *identified* and *undiscovered* U.S. resources at 300 million ounces.⁷⁵

⁷¹Office of Technology Assessment, *Strategic Materials: Technologies to Reduce U.S. Vulnerability*, p. 52.

⁷²Loebenstein, "Platinum-Group Metals," *Mineral Commodity Summaries—1987*, p. 119.

⁷³*Ibid.*, p. 21.

⁷⁴T. Anstett, D. Bleiwas, and C. Sheng-Fogg, *Platinum Availability—Market Economy Countries*, IC 8897 (Washington, DC: U.S. Bureau of Mines, 1982), p. 4.

⁷⁵*Ibid.*, p. 6.

Table 3-10.—Platinum. Group Metals in the National Defense Stockpile (as of Sept. 30, 1986)

Material	Goal	Inventory as	
		percent of goal	percent of goal
(thousand troy ounces)			
Platinum	1,310	440	34
Palladium	3,000	1,262	42
Iridium	98	30	30

^aThe Stockpile also contain 13,043 troy ounces of nonstockpile-grade Platinum and 2,214 ounces of palladium.

SOURCE: J.R. Loebenstein, "Platinum-Group Metals," *Mineral Commodity Summaries—1987* (Washington, DC: U.S. Bureau of Mines, 1987), p. 119.

⁶⁸The disparities in demand among PGMs and the variance in proportion and grade of individual metals recovered from PGM mineral deposits complicate the assessment of supply-demand for this metal group. For simplicity, the PGMs are discussed as a unit.

⁶⁹J. Loebenstein, "Platinum-Group Metals," *Mineral Commodity Summaries—1987* (Washington, DC: U.S. Bureau of Mines, 1987), p. 118.

⁷⁰J. Loebenstein, "Platinum-Group Metals," *Mineral Facts and Problems—1985 Edition*, Bulletin 675 (Washington, DC: U.S. Bureau of Mines, 1986), p. 599.

The PGM potential of the Stillwater Complex in Montana is higher than that of the other known domestic deposits. Stillwater PGMs are found in conjunction with nickel and copper. The Stillwater Mining Company, which is capable of producing 500 tons of ore per day, began producing PGMs in March 1987, but the mineral concentrates are being shipped abroad for refining to metal. Nearly 80 percent of the PGMs in Stillwater ores is palladium, and the remainder is mostly platinum. Platinum generally brings several times the price of palladium. The Salmon River deposit in Alaska is an alluvial gravel placer that is estimated to contain about 500,000 troy ounces of recoverable platinum. The Ely Spruce and Minnamax deposits in northeastern Minnesota are estimated to contain less than 800,000 troy ounces of platinum at the demonstrated level.⁷⁶

World resources are estimated to be about 3.3 billion troy ounces of PGMs. The world reserve base is about 2.1 billion troy ounces, with the Republic of South Africa controlling 90 percent of the reserves. Other major reserves are found in the U.S.S.R. and Canada. The United States has less than 10 percent of the world's total PGM resources.

Domestic Production

Domestic firms produced approximately 5,000 troy ounces of PGMs in 1986, all as byproducts from copper refining. The Republic of South Africa and the U.S. S. R. dominate world production of PGMs; in 1986 South Africa's mine production was 4 million ounces and the Soviet Union's was 3,7

million ounces of PGMs. Together they accounted for 95 percent of world production. It is expected that existing world reserves will have no problem in meeting cumulative demand through 2000.

Future Demand and Technological Trends

U.S. demand for PGMs in 2000 is expected to be between 2 million ounces and 3.3 million ounces (table 3-11) with the probable demand at about 2.9 million ounces. Domestic demand is forecast to grow at a rate of 2.5 percent annually between 1983 and 2000. Demand in the rest of the world is expected to increase more rapidly—perhaps 3 percent annually—due to the introduction of catalytic auto emission controls in Europe and Australia, and to the Japanese and U.S. emphasis on developing fuel cell technology as an alternative power source.

For most PGM end uses, the intensity of use has diminished since 1972.⁷⁷ Although intensity of use has declined, consumption has generally increased as a result of the growth of the automotive, electronic, and medical industries that consume platinum, palladium, and iridium. Since 1982, investors and speculators have been purchasing large quantities of platinum coins, bars, and ingots.

There are opportunities to reduce imports by improved recycling and substitution. About 97 percent of the PGMs used for petroleum refining and 85 percent of the catalysts used for chemicals and pharmaceutical manufacturing are recycled. Automobile catalysts are recycled much less frequently,

⁷⁶Ibid., p. 7.

⁷⁷Domestic Consumption Trends, 1972-82, and Forecasts to 1993 for Twelve Major Metals, p. 96.

Table 3-11.—Forecast of Demand for Platinum-Group Metals in 2000

Material	1983	2000		
		Low	Probable	High
		(thousand troy ounces)		
Platinum	797	900	1,300	1,400
Palladium	922	1,000	1,400	1,500
Rhodium	44	50	70	80
Ruthenium	145	140	210	230
Iridium	5	5	10	20
Osmium	1	1	2	4
Total platinum-group	1,914	2,000a	2,900	3,300

^aTotal differs from individual forecasts due to rounding.

SOURCE: J. Loebeinstein, "Platinum-Group Metals," *Mineral Facts and Problems—1985* (Washington, DC: U.S. Bureau of Mines, 1986), p. 611.

but recycling could increase if PGM prices escalate and if collection and waste disposal costs are reduced. It may be possible to reprocess as much as 200,000 troy ounces of PGMs annually from used automotive catalysts (about 3 percent of 1986 U.S. consumption).⁷⁸ Recycling of electronic scrap has collection and processing problems similar to recycling of automotive catalysts.

Substitution opportunities for PGMs in automotive catalysts are limited. Moreover, there is little incentive to seek alternatives for catalysts in the petroleum industry because a high proportion of PGMs used is currently recycled. Similarly, in the chemical and pharmaceutical industry, the value of the product far exceeds the return on investment for developing non-PGM substitutes, which usually are less efficient. It is possible to reduce the amount of PGMs used for electrical and electronic applications by substituting gold and silver for platinum and palladium.

Titanium (Ilmenite and Rutile)

Properties and Uses

Titanium is used as a metal and for pigments. Ninety-five percent of world production is used for white titanium dioxide pigment. Its high light reflectivity makes the pigment valuable in paints, paper, plastics, and rubber products. About 65 percent of the titanium pigments used domestically are for paint and paper.

Titanium alloys have a high strength-to-weight ratio and high heat and corrosion resistance. They, therefore, are well-suited for high technology applications, including high performance aircraft, electrical generation equipment, and chemical processing and handling equipment.

Although only 5 percent of all titanium goes into metal, it is an important material for aircraft engines. About 63 percent of the titanium metal consumed in the United States in 1985 was for aerospace applications. The remaining 37 percent was used in chemical processing, electric power generation, marine applications, and steel and other alloys. Titanium carbide is used in commercial cutting tools in combination with tungsten carbide.

⁷⁸Platinum, MCP-22 (Washington, DC: U.S. Bureau of Mines, 1978), p. 13.

Organotitanium compounds are used as catalysts in polymerization processes, in water repellents, and in dyeing processes.

National Importance

Over 80 percent of the titanium materials used in the United States are imported. The major sources of U.S. raw material imports are Canada and Australia. Other suppliers include the Republic of South Africa and Sierra Leone. The United States also imported about 5,500 tons of titanium metal in 1984 (about 5 percent of consumption), mainly from Japan, Canada, and the United Kingdom. Titanium's importance to the military and to the domestic aerospace industry makes this metal a second-tier strategic material ('strategic to some degree' with some small measure of potential supply vulnerability).⁷⁹ The current National Defense Stockpile goal for titanium sponge is 195,000 tons, and the current inventory is about 26,000 tons. The stockpile goal for rutile (used for metal production as well as pigments) is 106,000 tons, with the current inventory at 39,186 tons.

Domestic Resources and Reserves

The United States has reserves of about 7.9 million tons of titanium in the form of ilmenite and 200,000 tons in the form of rutile, both located mainly in ancient beach sand deposits in Florida and Tennessee and in ilmenite rock (table 3-12). The domestic reserve base of 23 million tons of titanium contains 15.5 million tons of ilmenite, 6.5 million tons of perovskite (not economically minable), and 900,000 tons of rutile. Total resources (including reserves and reserve base) are about 103 million tons of titanium dioxide, made up of 13 million tons of rutile, 30 million tons of ilmenite, 42 million tons of low-titanium dioxide ilmenite, and 18 million tons of perovskite.⁸⁰ These resources include large quantities of rutile at concentrations of about 0.3 percent in some porphyry copper ores and mill tailings.⁸¹

⁷⁹Office of Technology Assessment, *Strategic Materials: Technologies to Reduce U.S. Import Vulnerability*, p. 52.

⁸⁰E. Force and L. Lynd, *Titanium Mineral Resources of the United States—Definitions and Documentation*, Geological Survey Bulletin 1558-B (Washington, DC: U.S. Government Printing Office, 1984), p. B-1.

⁸¹E. Force, "Is the United States of America Geologically Dependent on Imported Rutile?," *Proceedings of the 4th Industrial Minerals International Congress*, Atlanta, GA, 1980.

Table 3-12.—U.S. Titanium Reserves and Reserve Base

	Reserves			Reserve base ^a		
	Ilmenite	Rutile	Total	Ilmenite ^b	Rutile	Total
	(thousand tons of contained titanium)					
Arkansas	—	—	—	—	100	100
California	—	—	—	400	—	400
Colorado	—	—	—	6,500	—	6,500
Florida	5,000	200	5,200	5,400	200	5,600
New York	2,700	—	2,700	5,300	—	5,300
Tennessee	200	10	210	3,700	600	4,300
Virginia	—	—	—	500	—	500
Total	7,900	210	8,110	22,000	900	23,000

^aThe reserve base includes demonstrated resources that are currently economic reserves, marginally economic reserves, and some that are currently subeconomic resources.

^bIlmenite except for 6.5 million tons in Colorado perovskite.

SOURCE: L. Lynd, "Titanium," *Mineral Facts and Problems—1985 Edition* (Washington, DC: US. Bureau of Mines, 1986), p. 663.

Domestic Production

The United States is the world leader in titanium pigment production, with 31 percent of the world's pigment capacity, far ahead of the Federal Republic of Germany in second place with 12 percent (figure 3-6). There were 11 U.S. titanium pigment plants operated by 5 firms in production in 1986. Their combined capacity was about 919,000 tons of pigment per year. Production in 1986 was about 917,000 tons, with nearly all of the plant capacity being utilized.

The United States accounts for about 25 percent of the world's titanium sponge production capacity, third behind the U.S.S.R. (39 percent) and Japan (28 percent). In 1985, total U.S. sponge capacity was about 33,500 tons annually, the Soviet capacity was about 53,000 tons, and the Japanese 38,000 tons. U.S. production of sponge in 1985 was about 23,000 tons, indicating that domestic producers were then operating at about 70 percent of capacity.

When demand peaked in 1981 due to rapid increases in aerospace use, the U.S. consumed about 32,000 tons of titanium metal. This surge in demand, which resulted in a temporary titanium shortage, prompted both the United States and Japan to increase their titanium metal production capacity. However, in 1982 the recession and overstocked inventories forced a cutback in sponge production in both countries to below 50 percent of capacity. Since then, the economic recovery and expansion of the U.S. military and commercial air fleets has increased domestic demand for titanium

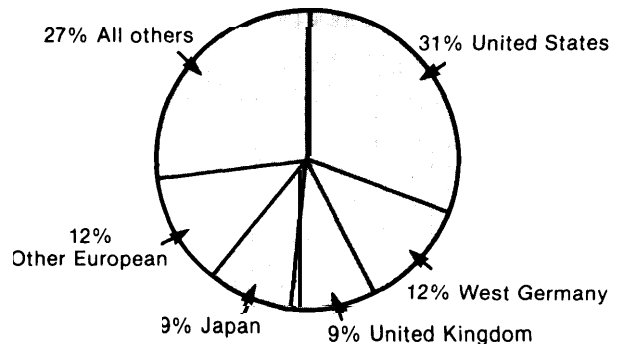
Figure 3-6.—World Titanium Pigment Manufacturing Capacity

Titanium dioxide is the major form of titanium used in the United States. It is primarily used for manufacturing pigments for paints and whiteners. The United States currently leads the world in pigment production.

SOURCE: Office of Technology Assessment, 1987

metal, but significant U.S. production capacity remains idle.

Production of titanium heavy minerals is driven primarily by demand for titanium dioxide pigments. E.I. du Pont de Nemours & Co., Inc., the world's largest titanium dioxide producer, obtains raw materials from its own mines in Florida and from a partially owned Australian subsidiary.

Currently, there are only two deposits producing heavy minerals from titaniferous sands in the United States. Both are in northeastern Florida, Trail deposit near Starke, Florida (du Pont), and the Green Cove Springs deposit (Associated Minerals (U.S.A.), Ltd.) near the community of the

same name.⁸² The six U.S. titanium sponge producers import rutile, the raw material now used for metal production in the market economy countries,⁸³ primarily from Australia, Sierra Leone, and the Republic of South Africa. Associated Minerals (U.S.A.), Ltd., is the sole domestic producer of natural rutile concentrate, although Kerr-McGee Chemical Corp. produces about 100,000 tons of synthetic rutile⁸⁴ from high-grade ilmenite through the removal of iron at its Mobile, Alabama, plant.

Future Demand and Technological Trends

Projected total titanium demand in 2000 is estimated at 750,000 tons, an increase of 43 percent from 1983; however, demand could range from a low of 600,000 tons to a high of 1 million tons (table 3-1 3).⁸⁵ The greatest percentage increase in titanium demand is expected to occur in the use

⁸²W. Harvey and F. Brown, *Offshore Titanium Heavy Mineral Placers: Processing and Related Considerations*, "OTA Contract Report, November 1986, p. 3.

⁸³Although the free market countries prefer to produce titanium metal from rutile, the U. S. S. R and People's Republic of China—which collectively produce 63 percent of the world titanium metal—manufacture metal from high-grade titanium oxide slag made from ilmenite. The process involves chlorination, purification, and reduction of titanium chloride. The U.S. could probably also use the same process to produce titanium metal feedstock, or synthetic rutile could be used.

⁸⁴Synthetic rutile is often referred to in the trade as "beneficiated" ilmenite. A natural analogue of this material is "Ieucoxene. Slagging processes are also used elsewhere to produce high-titanium dioxide, low-iron products from ilmenite.

⁸⁵Although titanium demand is equated to elemental titanium content, the major proportion of domestic demand will be for titanium dioxide.

of metals, which is projected to increase over five-fold, from 8,000 to 45,000 tons (this appears to be an optimistic estimate). Nevertheless, non-metal uses will continue to dominate the titanium market, probably approaching 700,000 tons by 2000, up from 515,000 tons in 1983.

In contrast, domestic titanium mine production in 2000 is projected at about 210,000 tons, an annual growth rate of about 4.6 percent from the 1982 level of 98,000 tons. Cumulative domestic mine production from the period 1983 to 2000 is projected to be 2.6 million tons titanium, significantly less than the probable cumulative primary non-metal demand of 10.5 million tons. Most of the future 7.9-million-ton shortfall is expected to be supplied by imports, even though domestic reserves of 7.8 million tons of ilmenite (contained titanium equivalent) and 199,000 tons of rutile (contained titanium equivalent) are considered sufficient to meet about 80 percent of expected U.S. non-metal demand in 2000.

Although a major proportion of future U.S. mine production is considered suitable for conversion to metal with intermediate processing,⁸⁶ nearly all of the titanium concentrates used for domestic metal production are expected to come from cheaper im-

⁸⁶These include intermediate products such as synthetic rutile and/or high-titanium slags. Such slags have been made from American ores. See G. Elger, J. Wright, J. Tress, et al., *Producing Chlorination-Grade Feedstock from Domestic Ilmenite—Laboratory and Pilot Plant Studies, RI-9002* (Washington, DC: U.S. Bureau of Mines, 1985), p. 24.

Table 3.13.—Forecast for U.S. Titanium Demand in 2000

End use	1983	2000		
		Low	Probable	High
(thousand tons contained titanium)				
Nonmetal:				
Paints	246	270	320	400
Paper products	137	160	200	280
Plastics and synthetics	66	80	100	140
Other	66	57	85	116
Total	515	570	700	940
Metal:				
Aerospace	4	15	23	29
Industrial equipment	2	7	13	20
Steel and alloys	2	5	9	13
Total	8	27	45	62
Grand total	523	600	750	1,000

SOURCE: L. Lynd, "Titanium," *Mineral Facts and Problems—1985 Edition* (Washington, DC: U.S. Bureau of Mines, 1988), p. 875.

ports. U.S. ilmenite reserves that *could* be used for metal production are estimated to contain about 10 times the probable forecast of metal cumulative demand of 490,000 tons by 2000.

Titanium Metal.—Titanium is one of only three metals expected to increase significantly in consumption and intensity of use; its demand is closely related to requirements for the construction of military and civilian aircraft. The outlook for titanium mill products through 1990 will depend primarily on military aircraft procurement and on the rate at which commercial air carriers replace aging fleets. The intensity of use (ratio of use to shipments) in the aerospace industry remained unchanged during the period 1972 to 1982. It is expected that significant replacement of titanium by carbon-epoxy composite materials—titanium's major competitor for lightweight, high-strength aircraft construction—will not occur before at least 1994. Titanium can be effectively used in conjunction with composite materials because their coefficients of thermal expansion match closely. Selection of titanium alloys over other materials for aerospace applications generally is based on economics and their special properties.

Because of its corrosion resistance and high-strength, titanium is likely to be increasingly used in industrial processes involving corrosive environments, although price has been somewhat of a deterrent to expanded commercial use. Non-aircraft industrial demand is currently showing strong growth in intensity of use of titanium. Automotive uses may also increase in the future. Currently, however, the use of titanium metal represents a relatively small amount of materials, and titanium dioxide for use in pigments and chemicals remains the major use in the United States.

Titanium Pigments.—Demand for paint pigments is projected to increase from 246,000 tons of titanium in 1983 to a probable level of 320,000 tons of titanium by 2000, but may range as low as 270,000 tons or as high as 400,000 tons. By 2000, metal and wood products precoated with durable plastic or ceramic finishes could be used in the construction industry, which would reduce or eliminate the need for repainting, thus adversely affecting demand growth of conventional coatings.

Paper products are projected to consume about 200,000 tons of titanium by 2000, up from 137,000 tons in 1983. The United States is the world's largest producer of paper, accounting for 35 percent of total world supply. The industry seems assured of continued growth, which should also be reflected in increased demand for titanium pigment.⁸⁷

Some substitution by alternative whiteners and coloring agents may be developed in the future which could slightly offset growth of titanium pigment usage, but it is projected that total pigment consumption will probably reach 640,000 tons of titanium by 2000.

Because production of titanium dioxide pigment by the chloride process results in fewer environmental problems than does the sulfate process, future trends are likely to be toward the development of concentrates that are suited as chlorination feed materials and for making metals. Future commercial applications for utilizing domestic ilmenite to produce high-titanium dioxide concentrates may have the potential to make the United States self-sufficient in supplying its titanium requirements, should they prove economically competitive. Technically, such concentrates can be produced from rutile, high-titanium dioxide ilmenite sands, leucoxene, synthetic rutile, and low-magnesium, low-calcium titaniferous slags. Perovskite found in Colorado also might be convertible to synthetic rutile or titanium dioxide pigment.

Phosphate Rock (Phosphorite)

Properties and Uses

Over 90 percent of the phosphate rock (a sedimentary rock composed chiefly of phosphate minerals) mined in the United States is used for agricultural fertilizers. Most of the balance of phosphate consumed domestically is used to produce sodium tripolyphosphate—a major constituent of household laundry detergents—and other sodium phosphates that are used in cleaners, water treatment, and foods. Phosphoric acid is also used in the manu-

⁸⁷U.S. Department of Commerce, *1986 U.S. Industrial Outlook* (Washington, DC: U.S. Government Printing Office, 1986), p. 5-5.

facture of calcium phosphates for animal feeds, dentifrices, food additives, and baking powder. Technical grades of phosphoric acid are used for cleaning metals and lubricants. Food-grade phosphoric acid is used as a preservative in processed foods.

National Importance

There is no substitute for phosphorus in agricultural uses; however, its use in detergents has been reduced by the substitution of other compounds to reduce environmental damage in lakes and streams partially caused by phosphorus enrichment (eutrophication).

The United States leads the world in phosphate rock production (table 3-14), but it is likely to be challenged by Morocco as the world's largest producer in future years. Domestic production supplies nearly all of the phosphorus used in the United States, except for a small amount of low-fluorine phosphate rock imported from Mexico and the Netherlands Antilles and high-quality phosphate rock for liquid fertilizers from Togo. The United States is currently a major exporter of phosphate rock and phosphate chemicals but is facing increased price competition from foreign sources (figure 3-7). Producers in the Middle East and North Africa may continue to encroach on U.S. export markets as new phosphorus fertilizer plants begin operation and U.S. production continues to shut down.

Table 3-14.—World and U.S. Phosphate Rock Production

Year	World Production (million tons)	U.S. Production (million tons)	U.S. production (percent)
1977	130	52	41
1978	138	55	40
1979	147	57	39
1980	173	60	34
1981	161	60	37
1982	136	41	30
1983	149	47	32
1984	166	54	32
1985	168	56	33
1986	154	44	29

SOURCE: Adapted from W. Stowasser and R. Fantel, "The Outlook for the United States Phosphate Rock Industry and its Place in the World," Society of Mining Engineers of AIME, Society of Mining Engineers, Inc., Reprint 65-116, 1965.

Figure 3.7.—Major World Exporters of Phosphate Rock Since 1975, With Projections to 1995

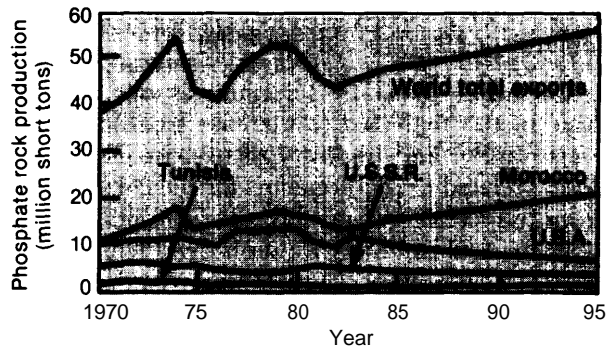

The United States is currently a major exporter of phosphate rock and phosphate chemicals but is facing increased price competition from foreign sources, principally Morocco. Domestic mines are shutting down, and some analysts believe that the U.S. industry is in danger of collapsing in the future.

SOURCE: W. Laver, "Phosphate Rock: Regional Supply and Changing Pattern of World Trade," Transactions of the Institution of Mining and Metallurgy, Sec. A—Mining Industry, July 1966, Transactions Vol. 95, p. A1 19.

Domestic Resources and Reserves

Phosphorus-rich deposits occur throughout the world, but only a small proportion are of commercial grade. Igneous phosphate rock (apatites) are also commercially important in some parts of the world. Commercial deposits in the United States are all marine phosphorites that were formed under warm, tropical conditions in shallow plateau areas where upwelling water could collect. U.S. phosphate rock reserves are estimated to be 1.3 billion tons at costs of less than \$32 per ton.⁸⁸ The reserve base is about 5.8 billion tons (at costs ranging from less than \$18 per ton to \$91 per ton), with total resources estimated at 6.9 billion tons. Over 70 percent of the U.S. reserve base is located in Florida and North Carolina. There are also large phosphate deposits in some Western States.

Although the United States has potentially vast *inferred* and hypothetical resources (7 billion tons and 24 billion tons of phosphate rock respectively), economic production thresholds for these resources have not been calculated. Other deposits probably

⁸⁸W. Stowasser and R. Fantel, "The Outlook for the United States Phosphate Rock Industry and its Place in the World, paper presented at the SME-AIME Annual Meeting, New York, NY, Feb. 24-28, 1985, Society of Mining Engineers Reprint No. 85-116, p. 5.

will likely be discovered. Deep phosphate rock deposits may also hold promise if economically acceptable means for recovering them without excessive surface disturbance can be developed. Hydraulic borehole technology may be adapted for this purpose, but very little is known about its economic feasibility and environmental acceptability.⁸⁹

The United States is a distant second in world *demonstrated* phosphate resources (19 percent) behind Morocco, whose enormous resources account for over 56 percent of the total *demonstrated* resources of the market economy countries, the U.S.S.R, and the Federal Republic of China⁹⁰ (table 3-1 5). Morocco alone may have sufficient resources to supply world demand far into the future.⁹¹

Domestic Production

The United States produced 44 million tons of phosphate rock in 1986, which accounted for about one-third of total world production. U.S. production of rock phosphate peaked in 1980-81 at approximately 60 million tons each year,⁹² Twenty-three domestic companies were mining phosphate rock in 1986, with an aggregate capacity of about 66 million tons. Of the domestic phosphate rock that was mined in 1984, 84 percent came from Florida and North Carolina.

The domestic phosphate industry is vertically integrated and highly concentrated.⁹³ Most of the phosphate rock produced in the United States is used to manufacture wet-process phosphoric acid, which is produced by digestion with sulfuric acid. Elemental phosphorus is produced by reducing phosphate rock in an electric furnace. About half the elemental phosphorus produced is converted to sodium tripolyphosphate for use in detergents.

⁸⁹J. Hrabik and D. Godesky, *Economic Evaluation of Borehole and Conventional Mining Systems in Phosphate Deposits*, IC 8929 (Washington, DC: U.S. Bureau of Mines, 1983), p. 34.

⁹⁰R. Fantel, G. Peterson, and W. Stowasser, "The Worldwide Availability of Phosphate Rock," *Natural Resources Forum* vol. 9, No. 1 (New York, NY: United Nations, 1985), pp. 5-23.

⁹¹R. Fantel, T. Anstett, G. Peterson, et al., *Phosphate Rock Availability—World*, IC 8989 (Washington, DC: U.S. Bureau of Mines, 1984), p. 12.

⁹²W. Stowasser, "Phosphate Rock," *Mineral Commodity Summaries—1987* (Washington, DC: U.S. Bureau of Mines, 1987), p. 116.

⁹³R. Fantel, D. Sullivan, and G. Peterson, *Phosphate Rock Availability—Domestic*, IC 8937 (Washington, DC: U.S. Bureau of Mines, 1983), p. 5.

Table 3-15.—World Phosphate Rock Reserves and Reserve Base

	Reserves ^a	Reserve base ^b
	(million tons)	
North America:		
United States	1,543	5,951
Canada		44
Mexico		12
Total	1,543	6,127
South America:		
Brazil	44	386
Colombia		110
Peru		154
Total	44	650
Europe:		
U. S.S.R	1,433	1,433
Other		154
Total	1,433	1,587
Africa:		
Algeria		276
Egypt		871
Morocco	7,604	22,040
Western Sahara	937	937
South Africa	2,865	2,865
Other	264	231
Total	11,670	27,220
Asia:		
China	231	231
Jordan	132	562
Syria		198
Other	55	485
Total	418	1,449
Oceania:		
Australia		551
Nauru	11	11
Total	11	561
World total	15,119	37,594

^aCost less than \$32 per ton. Cost includes capital, operating expenses, etc. and a 15 percent rate of return on investment. Costs and resources as of January 1983, f.o.b. mine.

^bCost less than \$91 per ton.

SOURCE: Adapted from W. Stowasser, "Phosphate Rock," *Mineral Facts and Problems—1985 Edition* (Washington, DC: U.S. Bureau of Mines, 1986), p. 582.

Future Demand and Technological Trends

Demand for phosphate rock is closely linked to agricultural production. Domestic primary demand for phosphate rock (including exports) grew from 31.2 million tons in 1973 to 45 million tons in 1980. The global recession that followed, coupled with agricultural drought conditions and government agricultural policies aimed at reducing excessive domestic grain inventories, reduced phosphate rock consumption to 31.7 million tons in 1982. Domestic consumption rebounded in 1984 to 46 million tons

as the world economy improved and U.S. grain production increased.⁹⁴ But depressed agricultural prices and increased operating costs have tended to stabilize demand growth as domestic farmers continue to struggle with the cost-price squeeze.

Probable domestic demand for phosphate rock is projected to be 52 million tons by 2000, with the low forecast at 50 million tons and the high at 55 million tons (table 3-1 6).⁹⁵ However, these forecasts are very uncertain due to global changes taking place in agricultural production. End uses in 2000 are expected to remain in about the same proportion as current uses.

From the mid-1970s, when exports represented about 40 percent of domestic production, the proportion of exported phosphate rock, fertilizers, and chemicals increased slowly through 1982 but decreased to its 10-year low by 1985. In 1983, fertilizer and chemicals slightly exceeded phosphate rock as export commodities (in terms of contained phosphorus pentoxide).⁹⁶

Competition for international market share is expected to increase. Economics favors the conversion of phosphate rock to higher valued chemicals and fertilizers for export. There is currently a trend in phosphate rock producing countries to expand facilities for processing raw material into intermediate or finished products, particularly among Middle Eastern and North African nations.

The U.S. share of world markets is expected to continue to decline in the future. Probable annual growth rate for phosphate fertilizer exports through

2000 is forecast to be 2 percent, with a low of 1.5 and a high of 3 percent.⁹⁷ Exports of phosphate rock are projected to decline at an annual rate of about 1 percent through 2000. In summary, the annual growth rate is expected to approach 0.8 percent from 1983 through 2000.

Future export levels of phosphate rock and phosphate fertilizer will be largely determined by the availability of resources from Florida and North Carolina, competition from foreign producers, and an increase in international trade of phosphoric acid rather than phosphate rock. U.S. phosphate rock supply is likely to be sufficient to meet demand through 1995, but demand could exceed domestic supply by 2000 if U.S. producers reduce domestic capacity as a result of foreign competition.

In addition to the domestic industry's problems with foreign competition and diminishing ore quality and quantity, problems associated with the environment affect phosphate rock mining and beneficiation. Environmental concerns include disposing of waste clay (slimes) produced from the beneficiation of phosphate ores, disposing of phosphogypsum from acid plants, developing acceptable reclamation procedures for disturbed wetlands, and operating with reduced water consumption.

Industry analysts think the phosphate industry's problems will grow with time. It is likely that the price will not increase enough to justify mining higher-cost deposits, and that the public will continue to oppose phosphate mining and manufacturing phosphatic chemicals. In that event, the remaining low-cost, high-quality deposits will continue to satisfy demand until they are exhausted or until the markets for phosphate rock or fertilizer become unprofitable. If domestic phosphate rock

⁹⁴W. Stowasser, "Phosphate Rock," *Mineral Facts and Problems—1985 Edition*, Bulletin 675 (Washington, DC: U.S. Bureau of Mines, 1986), p. 585.

⁹⁵Stowasser, "Phosphate Rock," *Mineral Facts and Problems—1985 Edition*, p. 591.

⁹⁶Stowasser and Fantel, "The Outlook for the United States Phosphate Rock Industry," pp. 85-116.

⁹⁷Stowasser, "Phosphate Rock," *Mineral Facts and Problems—1985 Edition*, p. 590.

Table 3-16.— Forecasts of U.S. and World Phosphate Rock Demand in 2000

	Actual	2000			Annual growth 1983-2000 (percent)
		Low	Probable	High	
United States	44 ^a	50	50 (million tons)	60	1.8
Rest of world	110	220	220	230	4.2
World total		270	270	290	3.6

^aU.S. data for 1986, from W. Stowasser, "Phosphate Rock," *Mineral Commodity Summaries—1987* (Washington, DC: U.S. Bureau of Mines, 1987), p. 116.

SOURCE: Adapted from W. Stowasser, "Phosphate Rock," *Mineral Facts and Problems—1985 Edition* (Washington, DC: U.S. Bureau of Mines, 1986), p. 592.

production costs continue to rise and investment in new mines is not justified, the shortfall between domestic supply and domestic demand will have to come from imports of lower-cost phosphate rock. ⁹⁸

Sand and Gravel

Properties and Uses

Sand and gravel is a nationally used commodity which is an important element in many U.S. industries and is used in enormous quantities. Sand and gravel can be used for industrial purposes such as in foundry operations, in glass manufacturing, as abrasives, and in infiltration beds of water treatment facilities.

Most sand and gravel, however, is used in construction. Much of the aggregate is used in concrete for residential housing, commercial buildings, bridges and dams, and in concrete or bituminous mixes for highway construction. A large percentage of sand and gravel is also used without binders as road bases, as road coverings, and in railroad ballast.

National Importance

Generally, there is an abundance of sand and gravel in the United States. Even though these materials are widely distributed, they are not universally available for consumptive use. Some areas are devoid of sand and gravel or may be covered with sufficient material to make surface mining impractical. In some areas, many sand and gravel sources do not meet toughness, strength, durability, or other physical property requirements for certain uses. Similarly, many sources may contain mineral constituents that react adversely when used as concrete aggregate. Furthermore, even though an area may be endowed with an abundance of sand and gravel suitable for the intended purpose, existing land uses, zoning, or regulations may preclude commercial exploitation of the aggregate.

Domestic Resources and Reserves

Sand and gravel resources are so extensive that resource estimates of total reserves are probably not

obtainable. Mineable resources occur both onshore and in coastal waters. Large offshore deposits have been located in the Atlantic continental shelf and offshore Alaska. ⁹⁹The availability of construction sand and gravel is controlled largely by land use and/or environmental constraints. Local shortages of sand and gravel are becoming common, especially near large metropolitan areas, and therefore onshore resources may not meet future demand. Crushed stone is being used often as a substitute, despite its higher price.

Domestic Production

In 1986, about 837 million tons of construction sand and gravel were produced in the United States, industrial sand and gravel production approached 28.5 million tons¹⁰⁰ and about 2.5 million tons of construction and industrial sand and gravel were exported. ¹⁰¹The domestic industry is made up of many producers ranging widely in size. Most produce materials for the local market. The western region led production and consumption of sand and gravel, followed by the east north-central, mountain, and southern regions.

Future Demand and Technological Trends

Demand forecasts for U.S. construction sand and gravel for 2000 range between a low of 650 million tons and a high of 1.2 billion tons, with the demand probably about 1 billion tons. Average annual growth in demand is expected to be about 2.9 percent annually through 2000. ¹⁰²Apparent consumption in 1986 was about 836 million tons.

Offshore resources may find future markets in certain urban areas where demand might outpace onshore supply because of scarcity or limited production due to land use or environmental con-

⁹⁹J. Williams, "Sand and Gravel Deposits Within the United States Exclusive Economic Zone: Resource Assessment and Uses, OTC 5197, Proceedings of the 18th Annual Offshore Technology Conference, Houston, Texas, May 5-8, 1986, p. 377.

¹⁰⁰V. Tepordei, "Sand and Gravel," *Mineral Commodity Summaries—1987* (Washington, DC: U.S. Bureau of Mines, 1985), pp. 136-137.

¹⁰¹V. Tepordei and L. Davis, "Sand and Gravel," *Minerals Yearbook—1984* (Washington, DC: U.S. Bureau of Mines, 1985), p. 775.

¹⁰²V. Tepordei, "Sand and Gravel," *Mineral Facts and Problems—198.5 Edition*, Bulletin 675 (Washington, DC: U.S. Bureau of Mines, 1986), p. 695.

* Ibid., p. 593.

straints. Such areas include New York, Boston, Los Angeles, San Francisco, San Juan, and Honolulu.

Garnet

Garnet is an iron-aluminum silicate used for high-quality abrasives and as filter media. Its size and shape in its natural form is important in determining its industrial use. The United States is the dominant world producer and user of garnet, accounting for about 75 percent of the world's output and 70 percent of its consumption. In 1986, the U.S. produced about 35,000 tons of garnet and consumed about 28,000 tons.¹⁰³ Domestic demand is expected to rise only modestly to about 38,000 tons per year by 2000.¹⁰⁴ World resources are very large and distributed widely among nations.

Monazite

Monazite is a rare-earth and thorium mineral found in association with heavy mineral sands. It is recovered mainly as a byproduct of processing titanium and zirconium minerals, principally in Australia and India. Domestic production of monazite is small relative to demand. As a result, the United States imports monazite concentrates and intermediates, primarily for their rare-earth content.

The rare earths are used domestically in a wide variety of end uses including: petroleum fluid cracking catalysts, metallurgical applications in high-strength low-alloy steels, phosphors used in color television and color computer displays, high-strength permanent magnets, laser crystals for high-energy applications such as fusion research and special underwater-to-surface communications, electronic components, high-tech ceramics, fiber-optics, and superconductors. It is estimated that about 15,400 tons of equivalent rare-earth oxides were consumed domestically in 1986.¹⁰⁵

¹⁰³G. Austin, "Garnet, Industrial," *Mineral Commodity Summaries—1987* (Washington, DC: U.S. Bureau of Mines, 1986), p. 56.

¹⁰⁴J. Smoak, "Garnet," *Mineral Facts and Problems—1985 Edition*, Bulletin 675 (Washington, DC: U.S. Bureau of Mines, 1986), p. 297.

¹⁰⁵J. Hedrick, "Rare-Earth Metals," *Mineral Commodity Summaries—1987* (Washington, DC: U.S. Bureau of Mines, 1986), p. 126.

Substitutes for the rare earths are available for many applications, but are usually much less effective. The United States imported 3,262 tons of monazite concentrates in 1986, representing about 12 percent of the total estimated domestic consumption of equivalent rare-earth oxides.

World resources of the rare-earth elements are large, and critical shortages of most of the elements are not likely to occur. Because domestic demand for thorium is small, only a small amount of the thorium available in monazite is recovered. It is used in aerospace alloys, lamp mantles, welding electrodes, high-temperature refractory applications, and nuclear fuel.

Zircon

Zircon is recovered as a byproduct from the extraction of titanium minerals from titaniferous sands. Zirconium metal is used as fuel cladding and structural material in nuclear reactors and for chemical processing equipment because of its resistance to corrosion. Ferrozirconium; zircon and zirconium oxide, is used in abrasives, refractories, and ceramics. Zircon is produced in the United States with about 40 to 50 percent of consumption imported from Australia, South Africa, and France.

Domestic consumption of contained zirconium was about 50,000 tons in 1983.¹⁰⁶ The United States is estimated to have about 14 million tons of zircon, primarily associated with titaniferous sand deposits. It is expected that domestic contained zirconium demand may reach about 116,000 tons by 2000, an annual growth of nearly 6 percent. Substitutes for zirconium are available, but at a sacrifice in effectiveness. Domestic reserves are gauged to be adequate for some time in the future although the United States imports much of that consumed from cheaper sources.

¹⁰⁶W. Adams, "Zirconium and Hafnium," *Mineral Facts and Problems—1985 Edition*, Bulletin 675 (Washington, DC: U.S. Bureau of Mines, 1986), p. 941.

Chapter 4
Technologies for Exploring the
Exclusive Economic Zone

CONTENTS

	<i>Page</i>
Introduction	115
Reconnaissance Technologies.	119
Side-Looking Sonars	119
Bathymetric Systems	124
Reflection and Refraction Seismology	132
Magnetic Methods..	136
Gravity Methods	138
Site-Specific Technologies.	139
Electrical Techniques	139
Geochemical Techniques	143
Manned Submersibles and Remotely Operated Vehicles	145
Optical Imaging.	152
Direct Sampling by Coring, Drilling, and Dredging	154
Navigation Concerns	162

Figures

<i>Figure No.</i>	<i>Page</i>
4-1. USGS Research Vessel S.P. Lee and EEZ Exploration Technologies.	117
4-2. GLORIA Long-Range Side-Looking Sonar	121
4-3. SeaMARC CL Images	125
4-4. Multi-Beam Bathymetry Products	126
4-5. Sea Beam Beam Patterns	127
4-6. Operating Costs for Some Bathymetry and Side-Looking Sonar Systems	129
4-7. Comparing SeaMARC and Sea Beam Swath Widths	130
4-8. Frequency Spectra of Various Acoustic Imaging Methods	133
4-9. Seismic Reflection and Refraction Principles	134
4-10. Seismic Record With Interpretation	135
4-11. Conceptual Design of the Towed-Cable-Array Induced Polarization System	142
4-12. A Tethered, Free-Swimming Remotely Operated Vehicle System.	147
4-13. Schematic of the <i>Argo-Jason</i> Deep-Sea Photographic System	153
4-14. Prototype Crust Sampler	159
4-15. Conceptual Design for Deep Ocean Rock Coring Drill.	162

Tables

<i>Table No.</i>	<i>Page</i>
4-1. Closing Range to a Mineral Deposit	116
4-2. Side-Looking Sonars	120
4-3. Swath Mapping Systems.	123
4-4. Bathymetry Systems	127
4-5. U.S. Non-Government Submersibles (Manned)	145
4-6. Federally Owned and Operated Submersibles.	146
4-7. U.S. Government Supported ROVs.	146
4-8. Worldwide Towed Vehicles	150
4-9. Vibracore Sampling Costs	155

Technologies for Exploring the Exclusive Economic Zone

INTRODUCTION

The Exclusive Economic Zone (EEZ) is the largest piece of "real estate" to come under the jurisdiction of the United States since acquisitions of the Louisiana Purchase in 1803 and the purchase of Alaska in 1867. The EEZ remains largely unexplored, both in the Lewis and Clark sense of gaining general knowledge of a vast new territory and in the more detailed sense of assessing the location, quantity, grade, or recoverability of resources. This chapter identifies and describes technologies for exploring this vast area, assesses current capabilities and limitations of these technologies, and identifies future technology needs.

The goal of mineral exploration is to locate, identify, and quantify mineral deposits, either for scientific purposes (e. g., better understanding their origin) or for potential commercial exploitation. Detailed sampling of promising sites is necessary to prove the commercial value of deposits. Obviously, it would be impractical and costly to sample the entire EEZ in the detail required to assess the commercial viability of a mineral deposit. Fortunately, this is not necessary as techniques other than direct sampling can provide many indirect clues that help researchers or mining prospectors narrow the search area to the most promising sites.

Clues to the location of potential offshore mineral accumulations can be found even before going to sea to search for them. The initial requirements of an exploration program for the EEZ are a thorough understanding of its geological framework and of the geology of adjacent coastal areas. In some instances, knowledge of onshore geology may lead directly to discoveries in adjacent offshore areas. For example, a great deal is currently known about the factors responsible for the formation of offshore heavy mineral deposits and gold placers. These factors include onshore sources of the minerals, transport paths, processes of concentration, and pres-

ervation of the resulting deposit.¹ In contrast, relatively little is known about the genesis of cobalt crusts or massive sulfides. Although a thorough understanding of known geology and current geological theory may not lead directly to a commercial discovery, some knowledge is indispensable for devising an appropriate offshore exploration strategy.

Rona and others have used the concept of 'closing range to a mineral deposit' to describe an exploration strategy for hydrothermal mineral deposits.² With some minor modifications this strategy may be applicable for exploration of many types of offshore mineral accumulations. It is analogous to the use of a zoom lens on a camera which first shows a large area with little detail but then is adjusted for a closeup view to reveal greater detail in a much smaller area. The strategy of closing range begins with regional reconnaissance. Reconnaissance technologies are used to gather information about the "big picture. While none of these techniques can provide direct confirmation of the existence, size, or nature of specific mineral deposits, they can be powerful tools for deducing likely places to focus more attention. As knowledge is acquired, exploration proceeds toward increasingly more focused efforts (see table 4-1), and the exploration technologies used have increasingly specific applications. Technologies that provide detailed information can be used more efficiently once reconnaissance techniques have identified the promising

¹H.E. Clifton and G. Luepke, "Heavy Mineral Placer Deposits of the Continental Margin of Alaska and the Pacific Coast States, *Geology and Resource Potential of the Continental Margin of Western North America and Adjacent Ocean Basins—Beaufort Sea to Baja California*, American Association of Petroleum Geologists, Memoir 43, in press, 1986, p. 2 (draft).

²P. A. Rona, "Exploration for Hydrothermal Mineral Deposits at Seafloor Spreading Centers, *Marine Mining*, Vol. 4, No. 1, 1983, pp. 20-26.

Table 4-1.—Closing Range to a Mineral Deposit

Approximate range to deposit	Method
10 kilometers	Long-range side-looking sonar Regional sediment and water sampling
1 kilometer	Gravity techniques Magnetic techniques Bathymetry Midrange side-looking sonar Seismic techniques
100 meters	Electrical techniques Nuclear techniques Short-range side-looking sonar
10 meters	Near-bottom water sampling Bottom images
0 meter	Coring, drilling, dredging Submersible applications

SOURCE: Adapted from P.A. Rona, "Exploration for Hydrothermal Mineral Deposits at Seafloor Spreading Centers," *Marine Mining*, vol. 4 No. 1, 1963, pp. 20-26.

areas. Systematic exploration does not necessarily mean comprehensive exploration of each acre of the EEZ.

Accurate information about seafloor topography is a prerequisite for detailed exploration. Side-looking sonar imaging and bathymetric mapping provide indispensable reconnaissance information. Side-looking sonar provides an image of the seafloor similar to that provided by aerial radar imagery. Its use has already resulted in significant new discoveries of subsea geological features within the U.S. EEZ. By examining side-looking sonar images, scientists can decide where to focus more detailed efforts and plan a more detailed exploration strategy.

Long-range side-looking sonar (e. g., GLORIA or SeaMARC II, described below) may show patterns indicating large seabed structures. At somewhat closer range, a number of other reconnaissance technologies (figure 4-1) may provide more detailed textural and structural data about the seabed that can be used to narrow further the focus of a search to a specific mineral target.



Photo credit: U.S. Geological Survey

USGS S.P. Lee

Figure 4-1.—USGS Research Vessel S.P. Lee and EEZ Exploration Technologies

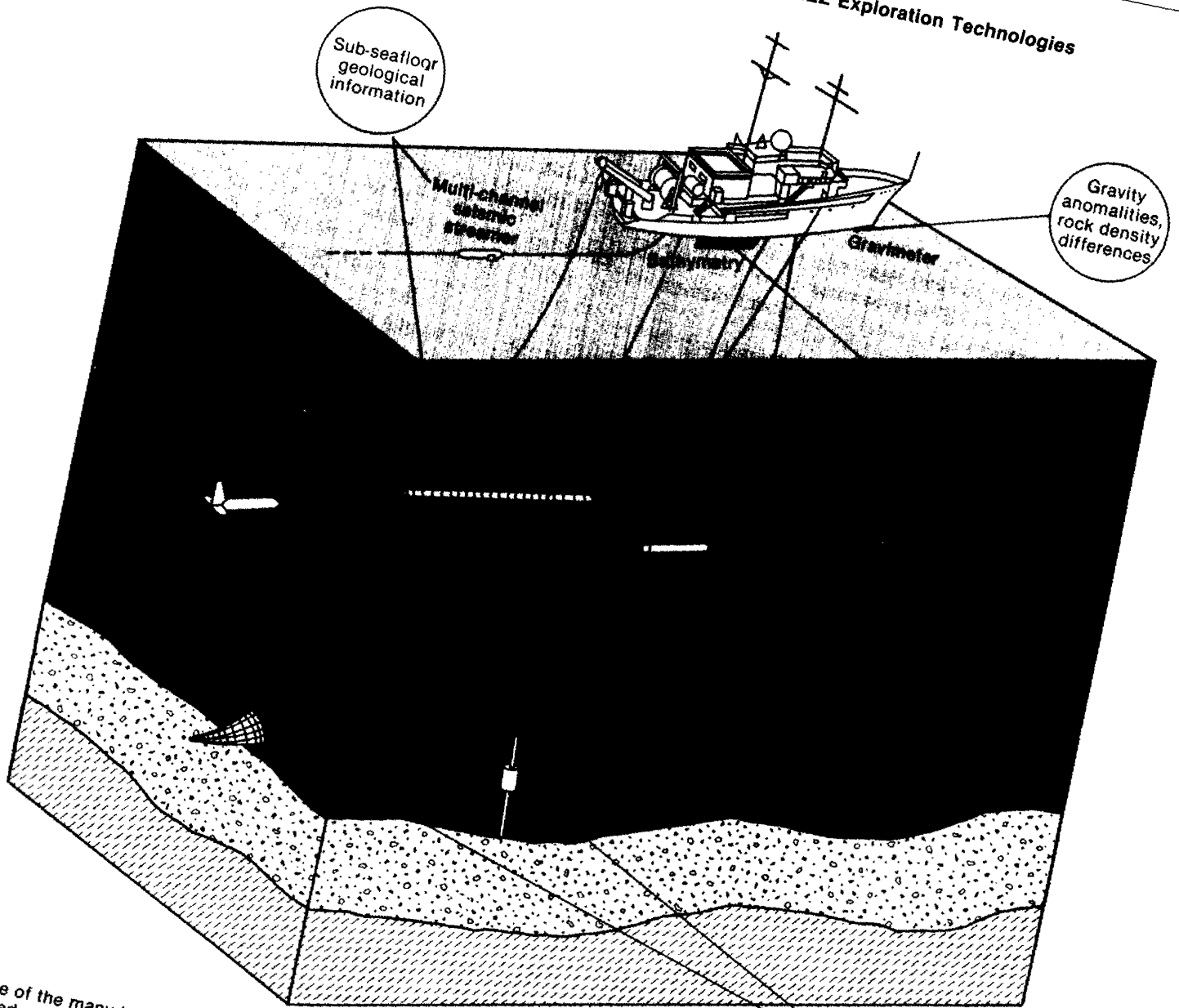

Some of the many technologies used to gather information about the seafloor and the mineral deposits found on or in the seabed are depicted here.

SOURCE: U.S. Geological Survey.

Some of the many technologies used to gather information about the seafloor and the mineral deposits found on or in the seabed are depicted here.

- Bathymetric profiling yields detailed information about water depth, and hence, of seabed morphology.
- Midrange side-looking sonars provide acoustic images similar to long-range sonars, but of higher resolution.
- Seismic reflection and refraction techniques acquire information about the subsurface structure of the seabed.
- Magnetic profiling is used to detect and characterize the magnetic field. Magnetic traverses may be used offshore to map sediments and rocks containing magnetite and other iron-rich minerals.
- Gravity surveys are used to detect differences in the density of rocks, leading to estimates of crustal rock types and thicknesses.
- Electrical techniques are used to study resistivity, conductivity, electrochemical activity, and other electrical properties of rocks.
- Nuclear techniques furnish information about the radioactive properties of some rocks.

Many of these reconnaissance technologies are also useful for more detailed studies of the seabed. Most are towed through the water at speeds of from 1 to 10 knots. Hence, much information may be gathered in relatively short periods of time. It is often possible to use more than one sensor at a time, thereby increasing exploration efficiency. Data sets can be integrated, such that the combined data are much more useful than information from any one sensor alone. Generally, the major cost of offshore reconnaissance is not the sensor itself, but the use of the ship on which it is mounted.

At still closer ranges, several other remote sensing techniques and technologies become useful. Short-range, higher frequency side-looking sonars provide very high resolution of seafloor features at a range of 100 meters (328 feet)³ and less. At less than about 50 meters in clear water, visual imaging is often used. Photographs or videotapes may be taken with cameras mounted on towed or low-

ered platforms or on either unmanned or manned submersibles. Instruments for sampling the chemical properties and temperature of near-bottom water also may be carried aboard these platforms.

Indirect methods of detection give way to direct methods at the seabed. Only direct samples can provide information about the constituents of a deposit, their relative abundance, concentration, grain size, etc. Grab sampling, dredging, coring, and drilling techniques have been developed to sample seabed deposits, although technology for sampling consolidated deposits lags behind that for sampling unconsolidated sediments. If initial sampling of a deposit is promising, a more detailed sampling program may be carried out. In order to prove the commercial value of a mineral occurrence, it may be necessary to take thousands of samples.

While some technology has been specifically designed for minerals exploration, much technology useful for this purpose has been borrowed from technology originally designed for other purposes. Some of the most sophisticated methods available for exploration were developed initially for military purposes. For instance, development of multi-beam bathymetric systems by the U.S. Navy has proven useful for civilian charting, oceanographic research, and marine minerals exploration. Much technology developed for military purposes is not immediately available for civilian uses. Some technologies developed by the scientific community for oceanographic research are also useful for minerals exploration.

Advances in technology usually generate interest in finding applications to practical problems. It is often costly to adapt technology for marine use. When the military defines a need, the cost of development of new technology is commonly less constrained than may be the case for the civilian sector. Conversely, although certain exploration techniques (e. g., for sampling polymetallic sulfides) are not yet very advanced, it does not necessarily follow that the technical problems in research and development are overwhelming. Identification of the need for new technology may be recent, and/or the urgency to develop the technology, which might be high for military use, may be relatively low for civilian use.

³Many geophysical and geological measurements are commonly expressed in metric units. This convention will be retained in this chapter. For selected measures, units in both metric and English systems will be given.

RECONNAISSANCE TECHNOLOGIES

Side-Looking Sonars

Side-looking sonars are used for obtaining acoustic images of the ocean bottom. Most side-looking sonars use ship-towed transducers which transmit sound through the water column to the seafloor. The sound is reflected from the seabed and returned to the transducer. Modern side-looking sonars measure both echo-time and backscatter intensity. As the ship moves forward, successive sound pulses are transmitted, received, and digitally recorded. Side-looking sonars were originally designed for analog operation (i. e., for producing a physical trace of the returned echo), but most now use digital methods to facilitate image processing. The data are usually processed to correct for variations in the ship's speed, slant-range distance to the seafloor, and attenuation of sound in the water. The final product is a sonograph, or acoustic image, of the ocean floor. It is also possible to extract information about the texture of some seabed deposits from the sonar signal. Side-looking sonars useful for EEZ exploration are of three types:

1. long-range (capable of mapping swaths 10 to 60 kilometers wide),
2. mid range (1 to 10 kilometers swaths), and
3. short range (< 1 kilometer swaths).⁴

Table 4-2 displays characteristics of several side-looking sonars.

Long-Range Side-Looking Sonar

One of the few technologies used to date to investigate large portions of the U.S. EEZ is a long-range side-looking sonar known as GLORIA (Geological Long Range Inclined Asdic) (figure 4-2). GLORIA was designed by the Institute of Oceanographic Sciences (IOS) in the United Kingdom and is being used by the U.S. Geological Survey (USGS) for obtaining acoustic images of the U.S. EEZ beyond the continental shelf.⁵ When proc-

essed, GLORIA images are similar to slant-range radar images. GLORIA's main contribution is that it gives geologists a valuable first look at expanses of the seafloor and enables them to gain insight about seabed structure and geology. For instance, the orientation and extent of large linear features such as ridges, bedforms, channels, and fracture zones can be determined.⁶ Horizontal separations as little as 45 meters (148 feet) and vertical distances on the order of a few meters can be resolved.

USGS is using GLORIA to survey the EEZ relatively inexpensively and quickly. GLORIA can survey swaths of seabed as wide as 60 kilometers (although, in practice, a 45-kilometer swath width is used to improve resolution). When towed 50 meters beneath the sea surface at 8 to 10 knots and set to illuminate a 60-kilometer swath, GLORIA is capable of surveying as much as 27,000 square kilometers (about 8,300 square nautical miles) of the seafloor per day. It is less efficient in shallow water, since swath width is a function of water depth below the sonar, increasing as depth increases. GLORIA can survey to the outer edge of the EEZ in very deep water.

Processing and enhancement of digital GLORIA data are accomplished using the Mini-Image Processing System (MIPS) developed by USGS.⁷ MIPS is able to geometrically and radiometrically correct the original data, as well as enhance, display, and combine the data with other data types. In addition, the system can produce derivative products, all on a relatively inexpensive minicomputer system.⁸ It is also possible now to vary the scale and projection of the data without having to do much manual manipulation.

⁴R. W. Rowland, M. R. Goud, and B.A. McGregor, "The U.S. Exclusive Economic Zone—A Summary of Its Geology, Exploration, and Resource Potential, U.S. Geological Survey, *Geological Circular* 912, 1983, p. 16.

⁷P. S. Chavez, "Processing Techniques for Digital Sonar Images From GLORIA, *Photogrammetric Engineering and Remote Sensing*, vol. 52, No. 8, 1986, pp. 1133-1145.

⁸G. W. Hill, "U.S. Geological Survey Plans for Mapping the Exclusive Economic Zone Using 'GLORIA', *Proceedings: The Exclusive Economic Zone Symposium: Exploring the New Ocean Frontier*, M. Lockwood and G. Hill (eds.), conference sponsored by National Oceanic and Atmospheric Administration, U.S. Department of the Interior, Smithsonian Institution, and Marine Technology Society, held at Smithsonian Institution, Oct. 2-3, 1985, p. 76.

⁴R. Vogt and B. E. Tucholke (eds.) "Imaging the Ocean Floor—History and State of the Art," in *The Geology of North America, Volume M, The Western North Atlantic Region* (Boulder, CO: Geological Society of America, 1986), p. 33.

⁵EEZ Scan 1984 Scientific Staff, *Atlas of the Exclusive Economic Zone, Western Conterminous United States*, U.S. Geological Survey Miscellaneous Investigations Series 1-1792, Scale 1:500,000, 1986.

Table 4.2.—Side-Looking Sonars

System	Frequency kilohertz	Max range km	Fish beamwidth degrees	Dimensions meters	Max weight pounds	Tow speed knots	Area coverage rate ^c km ² /day	Resolution at max range meters	Tow depth meters	Equipment Cost ^d M = millions K=thousand	Cost/km ²
Swath Map (SQS-26CX) ...	3.5	37	>2.5 x NA	hull mounted	—	20	66,000	>100	hull	— ^b	
GLORIA II ...	6.2/6.8	22.5	2.5 X 30	7.75 x .66 dia	4,000	10	20,000	100	50 typ	\$1.3M	\$2-\$4
SeaMARC II ...	11/12	10	2.0 x 40	5.5 x 1.3 dia	3,800	8	3,000	10	200 typ	\$1.2M	\$5-\$10
SeaMARC 1. ...	27/30	2.5	1.7 x 50	3 x 1.2x 1.1	1,300	5	1,100	5	6,000 max	\$900K	\$20-\$40
SEAMOR ...	27/30	3	1.7 x 50	3.8 X 1.9x 2.3	6,400	2	500	3	6,000 max	\$2M	
Deep Tow ...	110	1	.75 x 60	NA	2,000 (in water)	2	170	1	7,000	—	—
SAR ...	170/190	0.75	0.5x80	5 x 1.0 dia	4,800	2	130	0.75	6,100 max	—	—
EDO 4075.....	100	0.6	2.0 x 50	4.3 x 1.0 dia	2,000	2	104	0.5	6,000 max	\$600K	\$150-\$400
SeaMARC CL. ...	150	0.5	1.5 x 50	2 x .4x.4	175	2	97	0.5	1,500 max	\$250K	—
EG&G SMS 960.105		0.5	1.2 x 50	1.4 x.1 1 dia	55	15	670	0.5	600 max	\$96K	\$10-\$60
SMS 260.....	105	0.5	1.2 x 50	1.4 x.1 1 dia	55	15	670	0.5	600 max	\$42K	\$10-\$60
Klein . . .	50	0.5	1.5 x 40	1.5 x .09 dia	62	16	710	0.5	2,300 max	\$40-50K	\$10-\$60
	100	0.4	1.0 x 40	1.4 x .09 dia	52	16	570	0.4	2,300 max	\$40-50K	\$10-\$60
	500	0.2	0.2 x 40	1.2 x .09 dia	48	16	280	0.2	2,300 max	\$40-50K	\$10-\$60

^aCosts are for complete systems, including "fish" electronics (subsea and topside), analog or digital recording, and winch and cable. Winch and cable costs are substantial (\$250,000) for deep-water systems. The ship positioning system is not included, but fish positioning (relative to the ship) is included for deep-water systems (\$80,000). Costs probably tend to be underestimated because they are for more basic systems than would likely be used. In general, costs range from \$50,000 to \$150,000 for shallow systems, \$600,000 to \$900,000 for short-range, deep tow systems, and from \$1 million to \$3 million for long-range systems.

^bNo cost is estimated for SWATHMAP. A graphic recorder is the only extra equipment needed; if a frigate is equipped with an SQS-26CX sonar, no cost estimate is given for Deep Tow because it has been a constantly evolving system incorporating many more capabilities than just the imaging system. No cost is available for the French-developed SAR.

^cThe figures given for area coverage rate assume operations at maximum speed and maximum range 24 hours per day. In practice, transit time, weather delays, crosslines, equipment failures, etc. reduce the effective number of hours per day. In shallow water, the maximum useful range decreases because the image becomes distorted by refraction at shallow angles and its appearance deteriorates because of the changes in reflection characteristics if grazing angles are less than about 5°.

NA—not available.

SOURCE: National Oceanic and Atmospheric Administration.

Figure 4-2.—GLORIA Long-Range Side. Looking Sonar

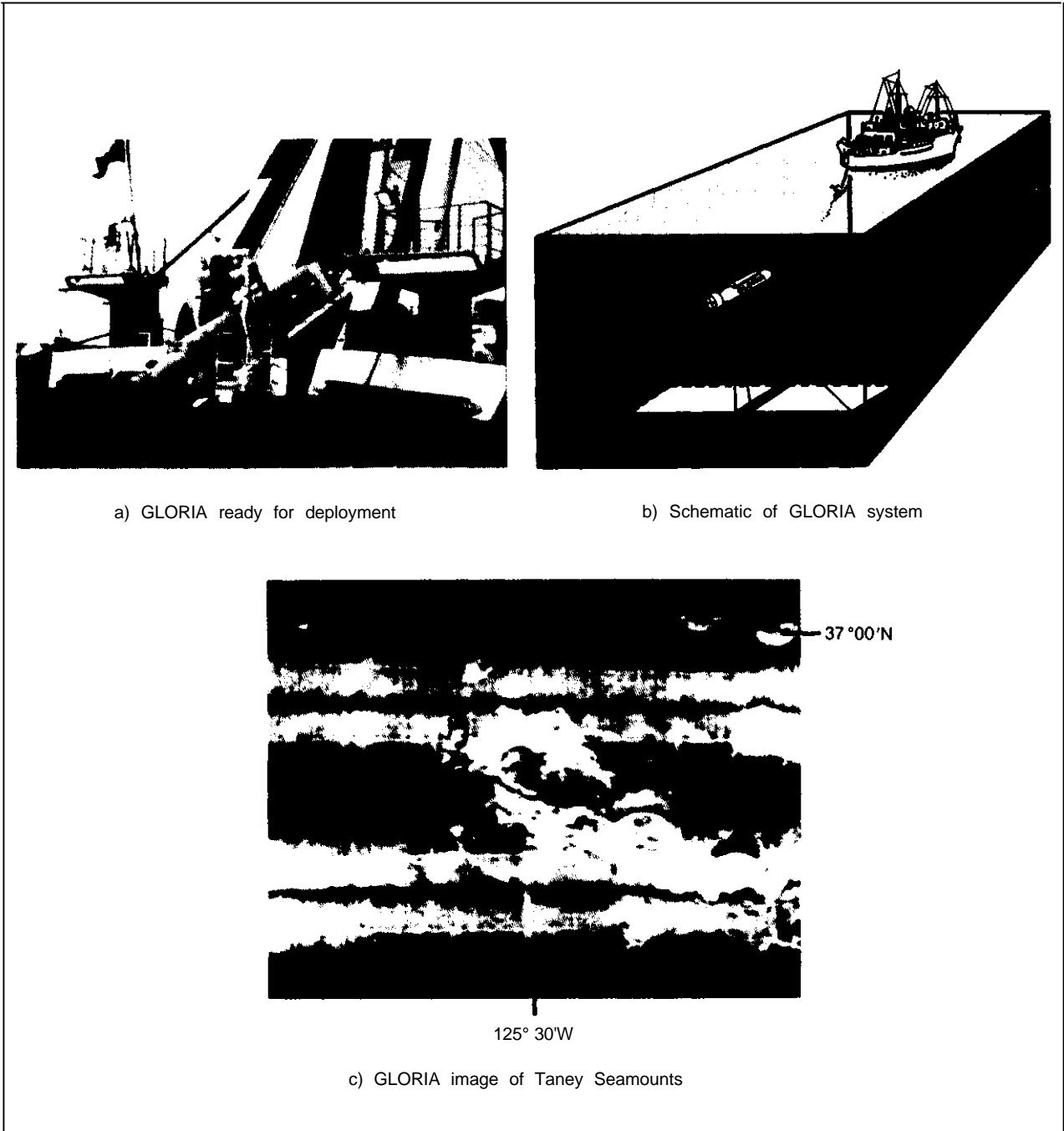

SOURCE: U S. Geological Survey.

USGS used GLORIA in 1984 to survey the EEZ adjacent to California, Oregon, and Washington. This entire area (250,000 square nautical miles) was surveyed in 96 survey days (averaging about 2,600 square nautical miles per day). In 1985, USGS used GLORIA to complete the survey of the Gulf of Mexico started in 1982 and to survey offshore areas adjacent to Puerto Rico and the Virgin Islands. In 1986, GLORIA surveys were conducted in parts of the Bering Sea and in Hawaiian waters. The benefits of using GLORIA data to reconnoiter the EEZ have become apparent in that, among other things, several dozen previously unknown volcanoes (potential sites for hard mineral deposits) were discovered.⁹ These and other features appear in USGS's recently published west coast GLORIA atlas, a collection of 36, 2- by 2-degree sheets at a scale of 1:500,000. ¹⁰Digital GLORIA data will be even more useful in the future, as additional bathymetric, magnetic, gravity, and other types of data are collected and integrated in the database.

USGS has now acquired its own GLORIA (it previously leased one owned by 10 S). Known as GLORIA Mark III, this newest system is an improved version of earlier models, incorporating titanium transducers and a digitized beam-steering unit to correct for yaw. ¹¹During the next several years, GLORIA Mark III is scheduled to survey Alaskan, Hawaiian, and Atlantic EEZs. The USGS plan is to survey the entire U.S. EEZ by 1991, with the exception of the U.S. Trust Territories, the ice-covered areas of the Beaufort and Chukchi Seas, and continental shelf areas (i. e., areas shallower than 200 meters (656 feet)).

The potential market for GLORIA surveys has recently attracted a private sector entrepreneur, Marconi Underwater Systems of the United Kingdom. Marconi is convinced that other coastal states will wish to explore their EEZs and will look to commercial contractors for assistance. Eventually, USGS also may be in a position to use its GLORIA for mapping the EEZs of other countries. Once the U.S. EEZ is surveyed, GLORIA would be available for use to explore EEZs of countries that have cooperative science programs with the United States.

⁹Ibid.

¹⁰EEZ Scan 1984 Scientific Staff, A *tlas*.

¹¹ I D, Swinbanks, "New GLORIA in Record Time," *Nature*, vol. 320, Apr. 17, 1986, p. 568.

USGS is coordinating its GLORIA program with the detailed EEZ survey program of the National Oceanic and Atmospheric Administration (NOAA). NOAA is using Sea Beam and Bathymetric Swath Survey System (BS³) technology (discussed below) to produce detailed bathymetric charts. NOAA uses GLORIA information provided by USGS for determining survey priorities. USGS geologists use NOAA's bathymetry in conjunction with GLORIA data to assist in interpreting the geologic features of the seafloor. The most accurate geological interpretations will result from use of many different types of data simultaneously: side-looking sonar, bathymetry, gravity, magnetic, seismic, electrical, etc.

Midrange Side-Looking Sonar

Like GLORIA, midrange systems record the acoustic reflection from the seafloor; however, they are capable of much higher resolution. In addition, whereas GLORIA is used to obtain a general picture of the seafloor, midrange and shortrange side-looking sonars are usually used for more detailed surveys. A seabed miner interested in looking for a specific resource would select and tune the side-looking sonar suitable for the job. For example, manganese nodule fields between the Clarion and Clipperton fracture zones in the Pacific Ocean were mapped in 1978 using an imaging system specially designed and built for that purpose.

The Sea Mapping And Remote Characterization systems—SeaMARC I and II—developed by International Submarine Technology, Ltd. (IST), and, respectively, Lamont-Doherty Geological Observatory and the Hawaii Institute of Geophysics (HIG), are two of several such systems available. SeaMARC I recently has been used to survey the Gorda and Juan de Fuca ridges. ¹²It can resolve tectonic and volcanic features with as little as 3 meters of relief. Higher resolution is obtained because midrange systems use wider bandwidths and generally operate at higher frequencies (10 to 80

¹²J.G Kosalos and D. Chayes, "A Portable System for Ocean Bottom Imaging and Charting," *Proceedings, Oceans 83*, sponsored by Marine Technology and IEEE Ocean Engineering Society, Aug. 29-Sept. 1, 1983, pp. 649-656.

¹³E.S.Kappel and W. B. F. Ryan, "Volcanic Episodicity and a Non-Steady State Rift Valley Along Northeast Pacific Spreading Centers: Evidence from Sea Marc I," *Journal of Geophysical Research*, 1986, in press

kilohertz) than long-range systems and because they are towed closer to the bottom.¹⁴ However, higher resolution is obtained at the expense of swath width.

SeaMARC I data is relatively expensive to acquire, given the smaller area that can be surveyed in a given time; however, SeaMARC I coverage in specific areas is a logical follow-on to GLORIA regional coverage, as the information it provides is of much higher resolution. For example, little is known about the small-scale topography of seamounts and ridges where cobalt crusts are found. SeaMARC I surveys (or surveys by a similar deep-towed system) will be needed to determine this small-scale topography before appropriate mining equipment can be designed.¹⁵

Interferometric Systems

By measuring the angle of arrival of sound echoes from the seafloor in addition to measuring echo amplitude and acoustic travel time, interferometric systems are able to generate multi-beam-like bathymetric contours as well as side-scanning sonar imagery (table 4-3).¹⁶ SeaMARC II developed jointly by 1ST and HIG, newer versions of Sea-

MARC I, and several other systems have this dual function capability.

SeaMARC II is a midrange to long-range side-looking sonar towed 100 meters below the surface (above SeaMARC I, below GLORIA). It is capable of surveying over 3,000 square kilometers (875 square nautical miles) per day when towed at 8 knots, mapping a swath 10 kilometers wide (20 kilometers or more when used for imaging only) in water depths greater than 1 kilometer. Some recent SeaMARC II bathymetry products have produced greater spatial resolution than Sea Beam or SASS bathymetry technologies (discussed below). Currently, SeaMARC II does not meet International Hydrographic Bureau accuracy standards for absolute depth, which call for sounding errors of no more than 1 percent in waters deeper than 100 meters. Although there are physical limits to improvements in SeaMARC accuracy, the substantial advantage in rate of coverage may outweigh needs for 1 percent accuracy, particularly in deep water.¹⁷ SeaMARC II's swath width is roughly four times Sea Beam's in deep water, so at similar ship speeds the survey rate will be about four times greater.

Two other SeaMARC systems, both of which will have the capability to gather bathymetry data and backscatter imagery, are now being developed at 1ST: SeaMARC TAMU and SeaMARC CL. SeaMARC TAMU is a joint project of the Naval Ocean Research and Development Activity, Texas A&M University, and John Chance Associates. The unit will be able to transmit and receive signals simultaneously at several frequencies, which may enable identification of texture and bottom roughness.

Concurrently, developments are underway to use Sea Beam returns to measure backscattering strength; hence, technical developments are beginning to blur the distinction between SeaMARC and Sea Beam systems.¹⁸ Additional advances in seabed mapping systems are being made in the design of tow vehicles and telemetry systems, in signal proc-

¹⁴Rowland, Goud, McGregor, "The U.S. Exclusive Economic Zone—Summary," p. 18.

¹⁵J. R. Hein, L.A. Morgenson, D.A. Clague, et al., "Cobalt-Rich Ferromanganese Crusts From the Exclusive Economic Zone of the United States and Nodules From the Oceanic Pacific, Geology and Resource Potential of the Continental Margin of Western North America and Adjacent Ocean Basins—Beaufort Sea to Baja California, D. Scholl, A. Grantz, and J. Vedder (eds.), American Association of Petroleum Geologists, Memoir 43, in press, 1986.

¹⁶J. G. Blackinton, D.M. Hussong, and J.G. Kosalos, "First Results From a Combination Side-Scan Sonar and Seafloor Mapping System (SeaMARC II)," *Proceedings, Offshore Technology Conference*, Houston, TX, May 2-5, 1983, OTC 4478, pp. 307-314.

Table 4-3.—Swath Mapping Systems

Image only	Image and bathymetry	Bathymetry only
<i>Side looking</i>	<i>Interferometric</i>	<i>Sector scan</i>
Swath Map	SeaMARC II	Hydrosearch
GLORIA	SeaMARC/S	SNAP
SeaMARC I	SeaMARC TAMU	<i>Multibeam</i>
SeaMARC II	Bathyscan	Sea Beam
SeaMARC CL	TOPO-SSS	BSSS/Hydrochart
Deep Tow		SASS
SAR		BOTASS
EDO 4075		Krupp-Atlas
EG&G SMS960		Honeywell-Elac
EG&G 260		Simrad
Klein		Benetech

SOURCE: International Submarine Technology, Ltd.

¹⁷D. E. Perry, National Oceanic and Atmospheric Administration, OTA Workshop on Technologies for Surveying and Exploring the Exclusive Economic Zone, Washington, DC, June 10, 1986.

¹⁸Vogt and Tucholke, "Imaging the Ocean Floors," p. 34.

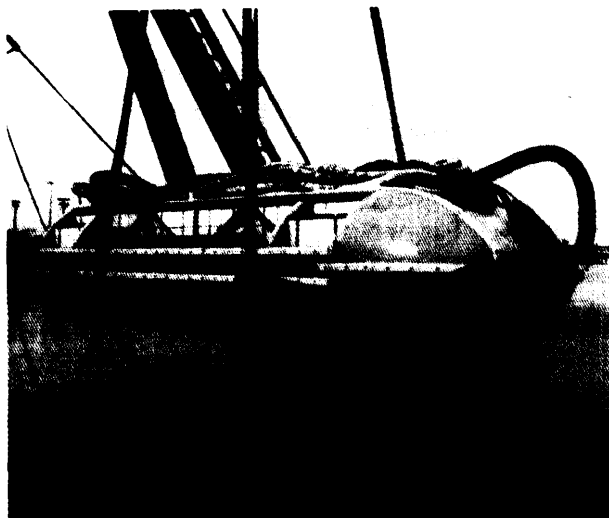

Photo credit: International Submarine Technology, Ltd.

Sea MARC II towfish

essing, in materials used in transducers, and in graphic recording techniques.¹⁹

Short-Range Side-Looking Sonar

Short-range side-looking sonar systems are used for acquiring acoustic images of small areas. They are not used for regional reconnaissance work, but they may be used for detailed imaging of seafloor features in areas previously surveyed with GLORIA or SeaMARC I or II. Operating frequencies of short-range sonars are commonly between 100 and 500 kilohertz, enabling very high resolution. Like midrange systems, they are towed close to the ocean bottom. Deep Tow, developed by Scripps Institution of Oceanography, has been used to study morphology of sediment bedforms and processes of crustal accretion at the Mid-Atlantic Ridge.²⁰ SAR (Système Acoustique Remorque) is a similar French system, reportedly capable of distinguishing objects as small as 30 by 76 centimeters (12 by 30 inches). It is towed about 60 meters off the seafloor and produces a swath of about 1,000 meters. Both of these deep-water systems have been used in the search for the *Titanic*.²¹

¹⁹M. Klein, "High-Resolution Seabed Mapping: New Developments," *Proceedings, Offshore Technology Conference*, Houston, TX, May 1984, p.75.

²⁰Vogt and Tucholke, "Imaging the Ocean Floor," p. 34.

²¹P.R. Ryan and A. Rabushka, "The Discovery of the *Titanic* by the U.S. and French Expedition," *Oceanus*, vol. 28, No. 4, winter 1985/86, p. 19.

SeaMARC CL is a short-range deep-towed interferometric system which is under development (figure 4-3). One model has been built for use in the Gulf of Mexico; another has been configured by Sea Floor Surveys International for use by the private sector and is available for hire. Shallow water, high-resolution, side-looking sonar systems developed by EG&G and Klein are used for such activities as harbor clearance, mine sweeping, and detailed mapping of oil and gas lease blocks.

Bathymetric Systems

Bathymetry is the measurement of water depths. Modern bathymetric technologies are used to determine water depth simultaneously at many locations. Very accurate bathymetric charts showing the topography of the seafloor can be constructed if sufficient data are collected with precise navigational positioning (figure 4-4). These charts are important tools for geological and engineering investigations of the seafloor, as well as aids to navigation and fishing. If bathymetric and side-looking sonar data are integrated and used jointly, the product is even more valuable.

Most existing charts are based on data acquired using single beam echo-sounding technology. This technology has now been surpassed by narrow, multi-beam technology that enables the collection of larger amounts of more accurate data. The older data were obtained without the aid of precise positioning systems. Moreover, existing data in the offshore regions of the EEZ generally consist of soundings along lines 5 to 10 miles apart with positional uncertainties of several kilometers.²² Charts in the existing National Oceanic and Atmospheric Administration/National Ocean Service (NOAA/NOS) series are usually compiled from less than 10,000 data points. In contrast, similar charts using the newer multi-beam technology are compiled from about 400,000 data points, and this quantity constitutes a subset of only about 2 percent of the observed data. Hence, much more information is available for constructing very detailed charts.

²²D. E. Pryor, "Overview of NOAA's Exclusive Economic Zone Survey Program," *Ocean Engineering and the Environment*, Oceans 85 Conference Record, sponsored by Marine Technology and IEEE Ocean Engineering Society, Nov. 12-14, 1985, San Diego, CA, pp. 1186-1189.

Figure 4-3.—SeaMARC CL images

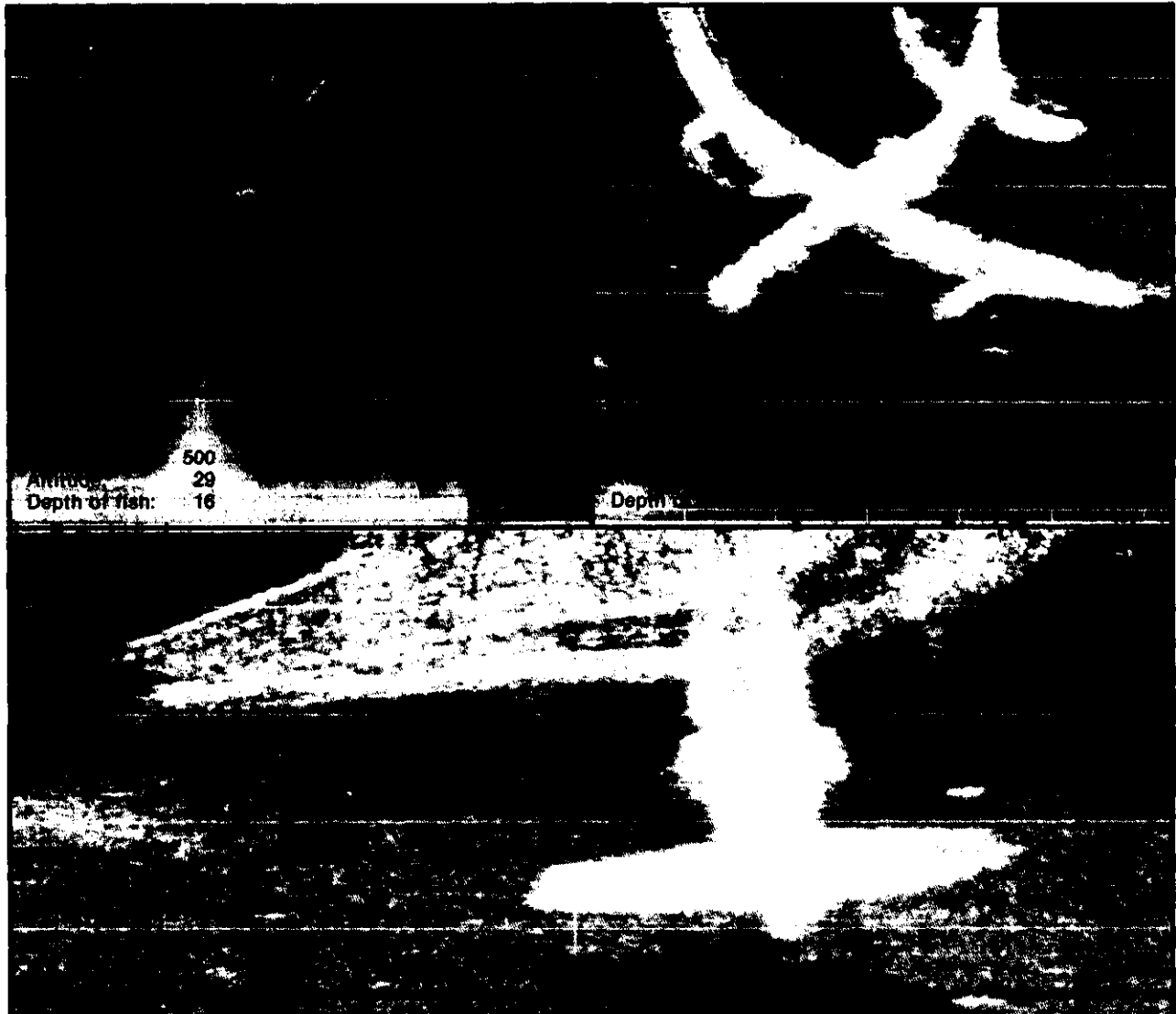

Three images made of a PB4Y aircraft at the bottom of Lake Washington near Seattle. Swath width, altitude, and depth of towfish varies.

SOURCE: International Submarine Technology, Ltd.

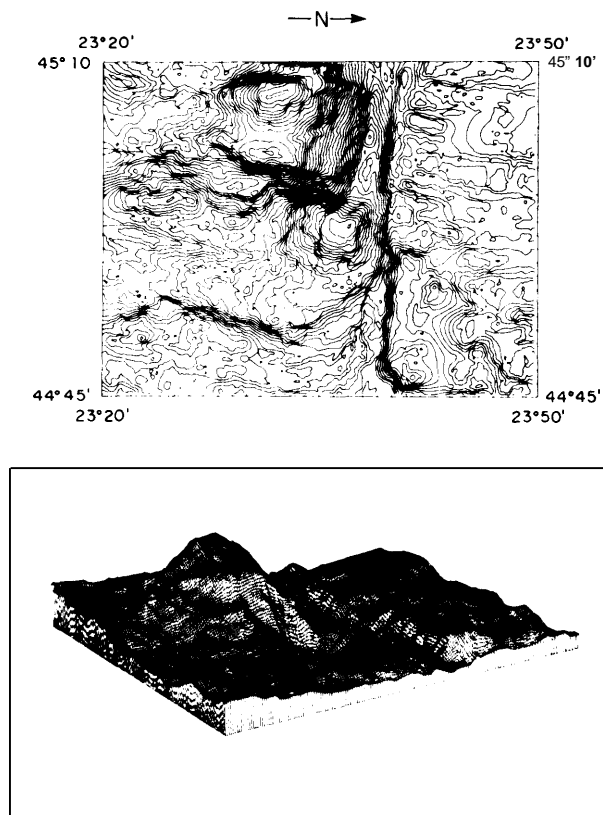
Figure 4-4.—Multi-Beam Bathymetry Products

a) Contour map of part of the Kane Fracture Zone, Mid-Atlantic Ridge

b) Three-dimensional Mesh Surface Presentation of the same data. Charts and 3-D presentations such as these are important tools for geological and engineering investigations of the seafloor,

SOURCE: R. Tyce, Sea Beam Users Group.

Improvements in seafloor mapping have resulted from the development of multi-beam bathymetry systems (table 4-4), the application of heave-roll-pitch sensors to correct for ship motion, the improved accuracy of satellite positioning systems, and improved computer and plotter capability for processing map data.²³ These improvements make possible:

²³C. Andreasen, "National Oceanic and Atmospheric Administration Exclusive Economic Zone Mapping Project, in *Proceedings: The Exclusive Economic Zone Symposium: Exploring the New Ocean Frontier*, M. Lockwood and G. Hill (eds.), conference sponsored by National Oceanic and Atmospheric Administration, U.S. Department of the Interior, Smithsonian Institution, and Marine Society, held at Smithsonian Institution, Oct. 2-3, 1985, pp. 63-67.

1. much higher resolution for detecting fine scale bottom features;
2. a significant decrease in time required for making area surveys;
3. nearly instantaneous automated contour charts, eliminating the need for conventional cartography;²⁴ and
4. the availability of data in digital format.

Deep-Water Systems

Swath bathymetric systems are of two types: those designed to operate in deep water and those designed primarily for shallow water. The principal deep-water multi-beam systems currently in use in the United States are Sea Beam and SASS. Sea Beam technology, installed on NOAA's NOS ships to survey EEZ waters deeper than 600 meters, first became available from General Instrument (GI) Corp. in 1977. GI's original multi-beam bathymetric sonar, the Sonar Array Sounding System (or SASS) was developed for the U.S. Navy and is not available for civilian use. Sea Beam is a spinoff from the original SASS technology.

Sea Beam is a hull-mounted system, which uses 16 adjacent beams, 8 port and 8 starboard, to survey a wide swath of the ocean bottom on both sides of the ship's track (figure 4-5). Each beam covers an angular area 2.670 square. The swath angle is the sum of the individual beam width angles, or 42.670. With the swath angle set, the swath width depends on the ocean depth. At the continental shelf edge, i.e., 200 meters, the swath width is about 150 meters at the bottom; in 5,000 meters (16,400 feet) of water, the swath width is approximately 4,000 meters. Therefore, Sea Beam's survey rate is greater in deeper waters. By carefully spacing ship tracks, complete (or overlapping) coverage of an area can be obtained. The contour interval of bathymetric charts produced from Sea Beam can be set as fine as 2 meters.

The Navy's older SASS model uses as many as 60 beams, providing higher resolution than Sea Beam in the direction perpendicular to the ship's track (Sea Beam resolution is better parallel to the ship's track). In current SASS models, the outer 10 or so beams are often unreliable and not used.²⁵

²⁴H. K. Farr, "Multibeam Bathymetric Sonar: Sea Beam and Hydrochart, *Marine Geodesy*, vol. 4, No. 2, pp. 88-89.

²⁵Vogt and Tucholke, "Imaging the Ocean Floor," p. 37.

Table 4-4.—Bathymetry Systems^a

System	Frequency kilohertz	Beams no.	Beamwidth degrees	Swath angle degrees	Max depth meters	System cost \$10 ⁶
Sea Beam	12	16	2.7	42.7	11,000	1,800
Super Sea Beam (proposed)	12	48	2	96	11,000	—
Towed Sea Beam (proposed)	17	32	2	64	—	—
BS ³ /Hydrochart II	36	21/17	5	105	600/1,000	1,200
KRUPP Atlas Hydrosweep ^b	19.5	59	1.8	90	10,000	2,000
Honeywell ELAC Superchart ^c	12	45	2	90	7,000	3,000
	50	61	2	120	600	3,000
Minichart	50	40	3	120	1,000	—
SIMRAD EM 100	95	32	2/2.5	40/80/104	420	500
HOLLMING Echos 15/625	12	15	2	42		
Echos AD	15	15	2	42	600	
	45	60	2	90	6,000	
BENTECH Benigraph ^d	1,000	200	0.5	100	30	2,000
	740	200	0.75	100	50	2,000
	500	200	1	100	60	2,000

^aInterferometric systems (e.g., SeaMARC II) are considered in table 4-2; however, they could be considered in the bathymetric table as well, as they have the potential of producing bathymetric data equivalent to that of multibeam systems. This system does not yet produce adequate bathymetric information, but improved versions are under development. Another system, the Bathyscan 300, has recently become commercially available. This system has demonstrated acceptable accuracy. It operates at 300 kilohertz, covers swaths of 200 meters width in waters less than 70 meters deep, weighs about 550 pounds, and costs about \$400,000.

^bKrupp-Atlas Hydrosweep is installed on the Meteor II, but is not yet operational.

^cThe characteristics of Honeywell's ELAC are quoted from proposals. Honeywell claims no system was built other than an experimental one. The company did supply transducers to the Hollming Shipyard in Finland for three Soviet ships. Data from Hollming indicates that the systems that were built using these transducers were virtual clones of the Sea Beam system.

^dBentech's Benigraph is oriented toward use in pipeline construction. The unit has very high resolution and a short range and can easily be scaled to lower frequencies and used as a mapping system. Company management has stated that this approach is their intention.

SOURCE: National Oceanic and Atmospheric Administration.

Figure 4-5.—Sea Beam Beam Patterns

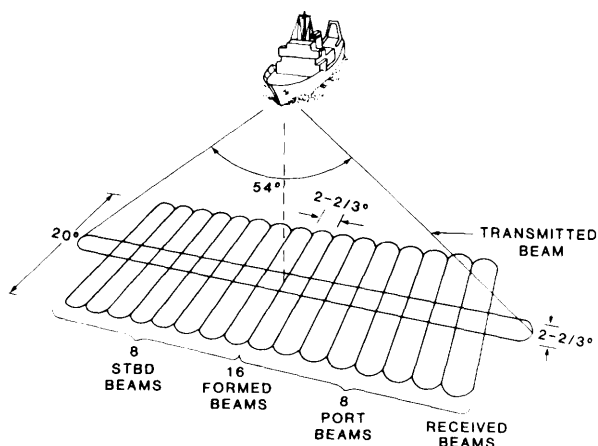

The Sea Beam swath width at the seafloor depends on water depth. In 200 meters of water the swath width is about 150 meters; in 5,000 meters of water, the swath width is approximately 4,000 meters.

SOURCE: R Tyce, Sea Beam Users Group

Hence, an upgraded SASS is now being designed that will be more reliable and will feature improved beam-forming and signal-processing capabilities. These should improve performance of the outer beams in deep water.

Improvements in Sea Beam, which has performed very well but which is now considered to be old technology, have also been proposed. One proposed modification is to develop a capability to quantify the strength of the signal returning from the bottom.²⁶ With such information, it would be possible to predict certain bottom characteristics. Nodule fields, for example, already have been quantified using acoustic backscatter information. Another proposed modification is to build a towed Sea Beam system. Such a system could be moved from ship to ship as required.²⁷

All bathymetric systems have resolution and range limits imposed by wave front spreading, absorption, and platform noise. However, by reducing Sea Beam's current beam width, its resolution can be improved. There are limitations to using the immense amounts of data that would be collected by a higher resolution system. Only a small fraction (2 percent) of existing Sea Beam data are

²⁶C. de Moustier, "Inference of Mangese Nodule Coverage From Sea Beam Acoustic Backscattering Data," *Geophysics* 50, 1985, pp. 989-1001.

²⁷D. White, Vice President, General Instruments, OTA Workshop on Technologies for Surveying and Exploring the Exclusive Economic Zone, Washington, DC, June 10, 1986.

used in making bathymetric charts (except for charts of very small areas), and generating charts with a 1-meter contour interval is impractical. Sea Beam, unlike SASS, may be installed on small ships. In order to build a Sea Beam with a 10 beam width, an acoustic array 2.5 times longer than current models would be required. To accommodate such an array, one must either tow it or use a larger ship. The Navy has found that the current Sea Beam system is capable of producing contour charts of sufficient quality for most of its needs and is currently considering deploying Sea Beam systems for several of its smaller ships.

It is important to match resolution requirements with the purpose of the survey. Use of additional exploration technologies in conjunction with Sea Beam data may provide better geological interpretations than improving the resolution of the Sea Beam system alone. For instance, combined bathymetry and side-looking sonar data may reveal more features on the seafloor.

Improving swath coverage is probably more important than improving resolution for reconnaissance surveys. Wider swath coverage, for example, could increase the survey rate and reduce the time and cost of reconnaissance surveys. Sea Beam's swath angle is narrow compared to that of GLORIA or SeaMARC (figure 4-6); thus the area that can be surveyed is smaller in the same time period. It may be possible to extend Sea Beam capability from the current 0.8 times water depth to as much as 4 times water depth without losing hydrographic quality.²⁸ The current limit is imposed by the original design; hence, a small amount of development may produce a large gain in survey coverage without giving up data quality.

Another factor that affects the survey rate is the availability of the Global Positioning System (GPS) for navigation and vessel speed. Currently, NOAA uses GPS when it can; however, it is not yet fully operational. When GPS is inaccessible, NOAA survey vessels periodically must approach land to maintain navigational fixes accurate enough for charting purposes. This reduces the time available for surveying. Ship speed is also a factor, but in-

creases in speed would not result in as great improvements in the survey rate as increases in swath width. Operating costs for some typical bathymetric systems are shown in figure 4-7.

Shallow-Water Systems

Several shallow-water bathymetric systems are available from manufacturers in the United States, Norway, West Germany, and Japan. NOAA uses Hydrochart, commonly known as the Bathymetric Swath Survey System (BS³), for charting in coastal waters less than 600 meters (1,970 feet) deep. One of the principle advantages BS³ has over Sea Beam is the wider angular coverage available, 105.0 versus 42.70, enabling a wider swath to be charted. This angular coverage converts to about 260 percent of water depth, in contrast to 80 percent of depth for Sea Beam. Data acquisition is more rapid for BS³ because the swath width is wider and transmission time in shallow water is reduced.²⁹ Hence, signal processing and plotting requirements for BS³ are different than those for Sea Beam. GI has recently introduced Hydrochart H, an improved version of Hydrochart. The principal difference is a maximum depth capability of 1,000 meters. With its 17 beams, Hydrochart II offers much greater resolution and accuracy than older single-beam sonars.

Along the narrow continental shelf bordering the Pacific Coast, bathymetry in very shallow water is fairly well known. Thus, NOAA has set an inshore limit of 150 meters for its BS³ surveys (except for special applications), even though BS³ is designed to be used in water as shallow as 3 meters. In regions where there are broad expanses of relatively shallow water and where the bathymetry is less well known, as off Alaska and along the Atlantic Coast, BS³ maybe used in water less than 150 meters deep.

Various bathymetric charting systems are currently under development which may enable systematic surveying of very shallow waters, limited only by the draft of the vessel. One such system, for use in waters less than 30 meters deep, is the airborne laser. Laser systems are under development by the U.S. Navy, the Canadians, Australians, and others. NOAA's work in this field

²⁸R. Tyce, Director, Sea Beam Users Group, OTA Workshop on Technologies for Surveying and Exploring the Exclusive Economic Zone, Washington, DC, June 10, 1986.

²⁹Farr, "Multibeam Bathymetric Sonar," p. 91.

Figure 4-6.—Operating Costs for Some Bathymetry and Side-Looking Sonar Systems

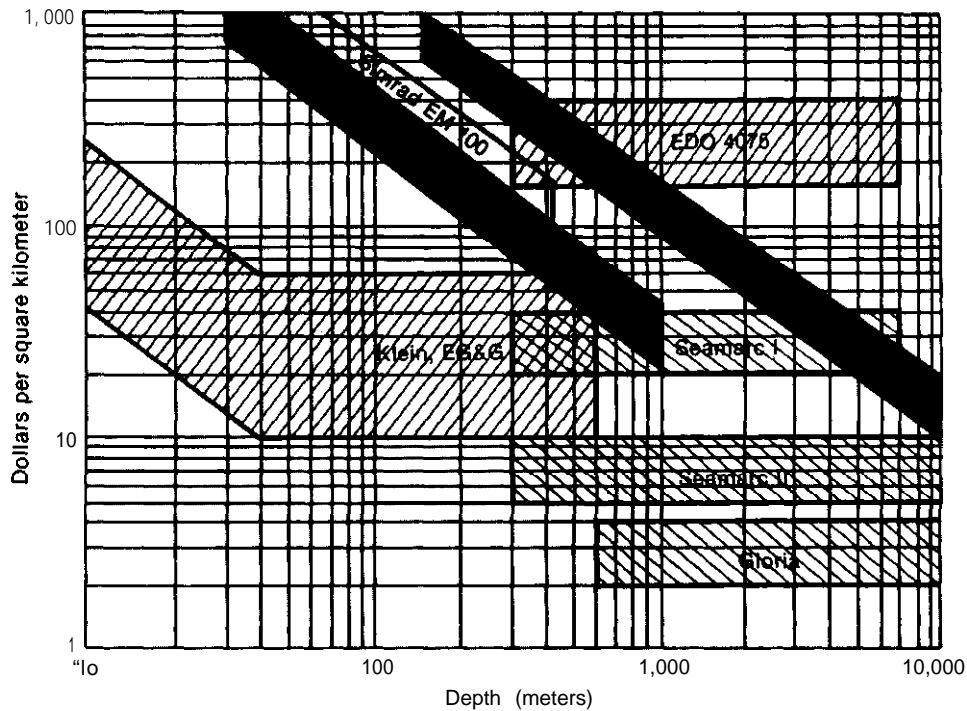

- NOTES:
1. Operating costs are not really system characteristics but are primarily determined by platform (ships, etc.) costs (including Positioning system operation). platform costs are highly variable. Variability is influenced more by economic conditions, ship operating costs, etc. than by survey system requirements.
 2. For shallow water imaging systems, work generally takes place in relatively protected areas not far from a port. Shallow water surveys can be performed using small (30-60 ft long) vessels at costs of from \$500-\$1200 per day, but operations would likely be limited to daylight hours. Considering daily transits, it would be difficult to survey more than 8 hours per day in an area or, given downtimes caused by inclement weather, to average more than 4 hours daily.
 3. Acquisition of deep water acoustic data commonly requires use of a larger, oceangoing vessel that can operate 24 hours a day. At this time, operational costs range from \$5K-\$15K a day for such vessels. With a system capable of withstanding 10 knot towing speeds, it should be possible to survey, on the average, 100 nautical track miles a day. Production goals for the *Surveyor* and the *Davidson* are 65 linear nautical miles per day.
 4. Several imaging systems can be operated in different modes to give higher resolution data, but this will be at a penalty to the cost of coverage.
 5. Experience with only three bathymetric systems is adequate enough (and not classified) to estimate operating costs. These are Sea Beam, BSSS/Hydrochart 11, and the Simrad EM100.
 6. Bathymetric system operating costs are based on the assumption that 100 nautical miles of seafloor a day can be surveyed using a vessel costing \$5K-\$15K per day.
 7. Costs of processing data (whether side-looking or bathymetric) are not included.

SOURCE: D. Pryor, National Oceanic and Atmospheric Administration.

Figure 4-7.—Comparing SeaMARC and Sea Beam Swath Widths

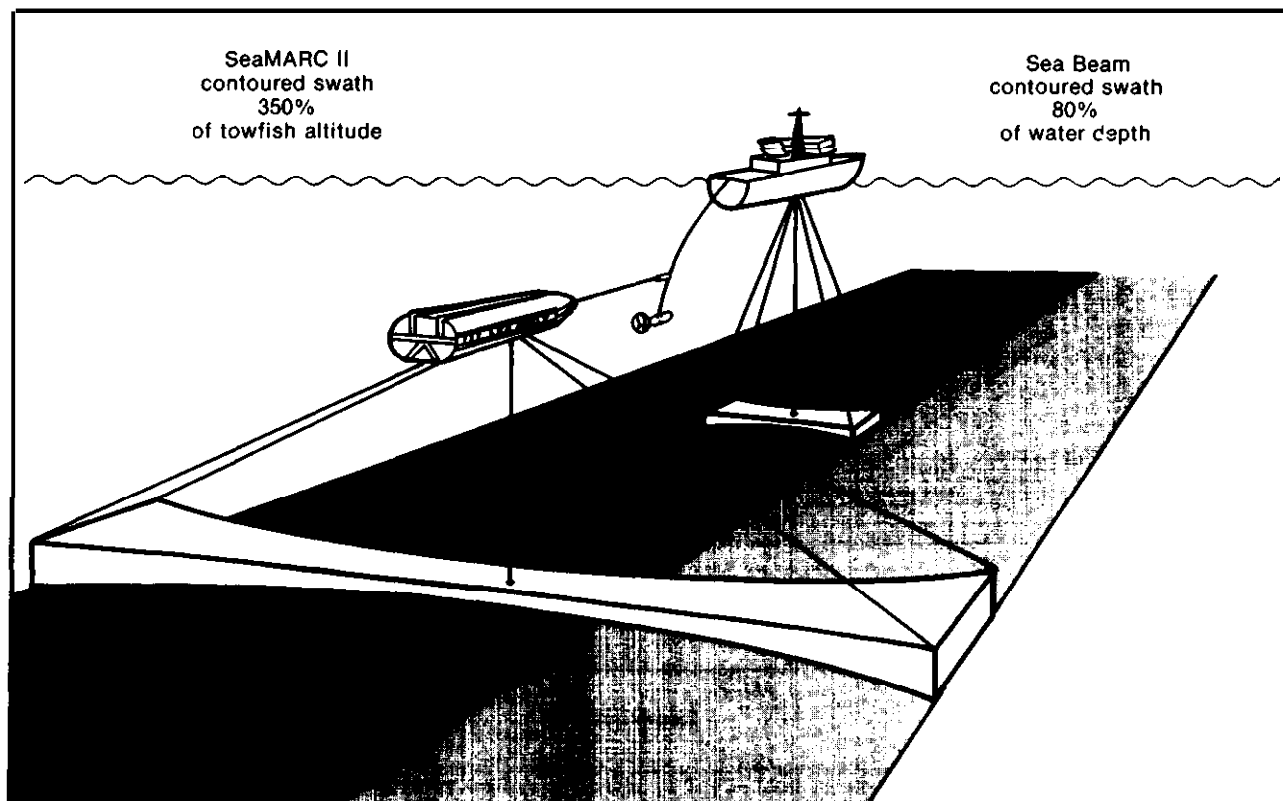

The SeaMARC II system can acquire both bathymetric data and sonar imagery and has a swath width more than four times that of the Sea Beam system. The **Sea Beam** system, however, produces more accurate bathymetry.

SOURCE: International Submarine Technology, Ltd., Redmond, WA.

stopped in 1982, due to limited funds. The Canadian system, the Larsen 500, is now being used by the Canadian Hydrographic Service. The Australian laser depth sounding system, WRELADS, has been used experimentally to map a swath 200 meters wide.³⁰ Water must be clear (i. e., without suspended sediments) for the airborne lasers to work. Towed underwater lasers have not yet been developed.

Another method currently under development for use in very shallow water is airborne electromagnetic (AEM) bathymetry. This technique has recently been tested at sea by the Naval Ocean Re-

search and Development Activity (NORDA).³¹ NORDA reports that with additional research and development, the AEM method maybe able to produce accurate bathymetric charts for areas as deep as 100 meters. Passive multispectral scanners also have been applied to measuring bathymetry.³² A combination of laser, AEM, and multispectral techniques may be useful to overcome the weather and turbidity limits of lasers alone. Satellite altimeters and synthetic aperture radar images of surface expressions can also indicate bathymetry, but much

³⁰R. K. Bullard, "Land Into Sea Does Not Go," *Remote Sensing Applications in Marine Science and Technology*, A.P. Cracknell (ed.) (Hingham, MA: D. Reidel Publishing Co., 1983), p. 366.

³¹I. J. Won and K. Smits, "Airborne Electromagnetic Bathymetry," *Norda Report 94*, U.S. Navy, Naval Ocean Research and Development Activity, April 1985.

³²D. R. Lyzenga, "Passive Remote Sensing Techniques for Mapping Water Depth and Bottom Features," *Applied Optics*, vol.17, No. 3, February 1978, pp. 29-33.

less accurately.³³ If airborne bathymetric survey techniques for shallow water can be further refined, they would have the distinct advantage over ship-based systems of being able to cover much more territory in much less time and at reduced cost. Technology for airborne surveys in deep water has not yet been developed.

Systematic Bathymetric Mapping of the EEZ

NOAA has recently begun a long-range project to survey and produce maps of the entire U.S. EEZ. The NOAA ship *Surveyor* is equipped with Sea Beam and has been mapping the EEZ since May 1984. Initial Sea Beam surveys were made of the Outer Continental Shelf, slope, and upper rise off the coasts of California and Oregon.³⁴ A second Sea Beam was installed aboard *Discoverer* in 1986. The *Davidson* has been equipped with BS³ since 1978, NOAA plans to acquire two additional swath mapping systems with 1987 and 1988 fiscal year funds.

NOAA is currently able to map between 1,500 and 2,500 square nautical miles per month (with two ships, *Surveyor* and *Davidson*, working on the west coast continental slope). This is significantly below the expected coverage rate for the Sea Beam. Transit time, weather, crosslines, equipment failure, and decreased efficiency in shallower water are factors that have limited production to about 50 square nautical miles per ship per day. Moreover, NOAA has not yet surveyed any areas beyond 120 miles from the coast. With the GPS available only part-time, too much time would be wasted in maintaining accurate navigation control on the outer half of the EEZ. Delays in launching satellites, the Challenger accident, and several recent failures of GPS satellites already in orbit are further eroding the near-term usefulness of GPS and, therefore, limiting the efficiency of NOAA surveys.

³³W. Alpers and I. Hennings, "A Theory of the Imaging Mechanism of Underwater Bottom Topography by Real and Synthetic Aperture Radar," *Journal of Geophysical Research*, vol. 89, No. C6, Nov. 20, 1984, pp. 10,529-10,546.

³⁴D. E. Pryor, "NOAA Exclusive Economic Zone Survey Program," in *PA CON 86*, proceedings of the Pacific Congress on Marine Technology, sponsored by Marine Technology Society, Hawaii Section, Honolulu, HA, Mar. 24-28, 1986, pp. OST5/9,10.

The agency would like to map all 2.3 million square nautical miles of the U.S. EEZ. With current technology, funding, and manpower, this project could take more than 100 years. In order to ensure that the most important areas are surveyed first, NOAA consults with USGS and uses USGS's GLORIA side-looking sonar imagery to select survey targets. USGS has provided funds to NOAA for data processing; in return, NOAA accepts the survey priorities set by USGS.

By mid-1986, less than 1 percent of the U.S. EEZ had been systematically surveyed with NOAA's Sea Beam and BS³ systems. To date, few of the charts or raw data have been publicly released because the U.S. Navy has determined that public dissemination of high-resolution bathymetric data could endanger national security. NOAA and the Navy are currently exploring ways to reduce the security risks while producing bathymetric charts useful for marine geologists, potential seabed miners, fishermen, and other legitimate users (see ch. 7).

NOAA's Survey Program is the only systematic effort to obtain bathymetry for the entire EEZ; however, several academic institutions have mapped small portions of the EEZ. For instance, Woods Hole Oceanographic Institution, Lamont-Doherty Geological Observatory, and Scripps Institution of Oceanography have their own Sea Beam systems. Much of the mapping these institutions have done has been outside the U.S. EEZ. Moreover, additional bathymetric data (how much of it useful is unknown) are gathered by the offshore petroleum industry during seismic surveys. As much as 10 million miles of seismic profiles (or about 15 percent of the EEZ) have been shot by commercial geophysical service companies in the last decade, and almost all of these surveys are believed to contain echo soundings in some form (probably mostly 3.5 kilohertz data).³⁵ Some of these data are on file at the National Geophysical Data Center (NGDC) in Boulder, Colorado; however, most remain proprietary. Moreover, maps made from these data might

³⁵R. B. Perry, "Mapping the Exclusive Economic Zone," *Ocean Engineering and the Environment*, Oceans 85 Conference Record, Sponsored by Marine Technology Society and IEEE Ocean Engineering Society, Nov. 12-14, 1985, San Diego, CA, p. 1193. The seismic profiles themselves generally include ocean bottom reflections when water depths are more than about 150 meters. These profiles are accurate, continuous bathymetric records along the line of survey.

also be considered classified under current Department of Defense policy. The grid lines are often only one-quarter mile apart, indicating that these maps would be very accurate (although a standard 3.5 kilohertz echo sounding does not have the resolution of Sea Beam) .36

NOAA is currently exploring ways to utilize data acquired by academic and private institutions to upgrade existing bathymetric maps to avoid duplication. In some areas, it may be possible to accumulate enough data from these supplemental sources to improve the density and accuracy of coverage. However, because these data usually were not gathered for the purpose of making high-quality bathymetric maps, these data may not be as accurate as needed. NOAA is adhering to International Hydrographic Bureau standards because these standards are: widely accepted by national surveying agencies, result in a product with a high degree of acceptance, and are feasible to meet. NOAA could relax its standards if this meant that an acceptable job could be done more efficiently. For example, if depth accuracy of the SeaMarc 11 system (which has a much wider swath width than Sea Beam) could be improved from the present 3 percent of depth to 1.5 percent or better, NOAA might consider using SeaMarc II in its bathymetric surveys.

Public data sets rarely have the density of coverage that would provide resolution approaching that of a multi-beam survey. Commercial survey data are not contiguous over large areas because they cover only selected areas or geologic structures. Data may be from a wide beam or deep seismic system, possibly uncorrected for velocity or unedited for quality. Data sets would also be difficult to merge. Unless the lines are sufficiently dense, computer programs cannot grid and produce contours from the data at the scale and resolution of multi-beam data.³⁷

SASS data acquired by the U.S. Navy is classified. NOAA neither knows what the bathymetry is in areas surveyed by SASS nor what areas have been surveyed. More optimistically, once the

Global Positioning System becomes available around the clock, thereby enabling precise navigational control at all times, it may be possible for NOAA to utilize multi-beam surveys conducted by others, e.g., by University National Oceanographic Laboratory System (UNOLS) ships. If the three university ships currently equipped with Sea Beam could be used as 'ships of opportunity' when otherwise unemployed or underemployed, both NOAA and the academic institutions would benefit. NOAA has already discussed the possibility of funding Sea Beam surveys with the Scripps Institution of Oceanography.

Reflection and Refraction Seismology

Seismic techniques are the primary geophysical methods for acquiring information about the geological structure and stratigraphy of continental margins and deep ocean areas. Seismic techniques are acoustic, much like echo sounding and sonar, but lower frequency sound sources are used (figure 4-8). Sound from low-frequency sources, rather than bouncing off the bottom, penetrates the bottom and is reflected or refracted back to one or more surface receivers (channels) from the boundaries of sedimentary or rock layers or bodies of different density (figure 4-9). Hence, in addition to sedimentary thicknesses and stratification, structural characteristics such as folds, faults, rift zones, diapirs, and other features and the characteristic seismic velocities in different strata may be determined (figure 4-10).

Seismic reflection techniques are used extensively to search for oil, but they are also used in mineral exploration. Reflection techniques have been and continue to be refined primarily by the oil industry. Seismic refraction, in contrast to seismic reflection, is used less often by the oil industry than it once was; however, the technique is still used for academic research. Ninety-eight percent of all seismic work supports petroleum exploration; less than 2 percent is mineral oriented.

The depth of wave penetration varies with the frequency and power of the sound source. Low-frequency sounds penetrate deeper than high-frequency sounds; however, the higher the frequency of the sound source, the better the resolution possible. Seismic systems used for deep penetration

³⁶C. Savit, Senior Vice President, Western Geophysical, OTA Workshop on Technologies for Surveying and Exploring the Exclusive Economic Zone, Washington, DC, June 10, 1986.

³⁷Perry, "Mapping the Exclusive Economic Zone," p. 1193.

Figure 4-8.—Frequency Spectra of Various Acoustic Imaging Methods

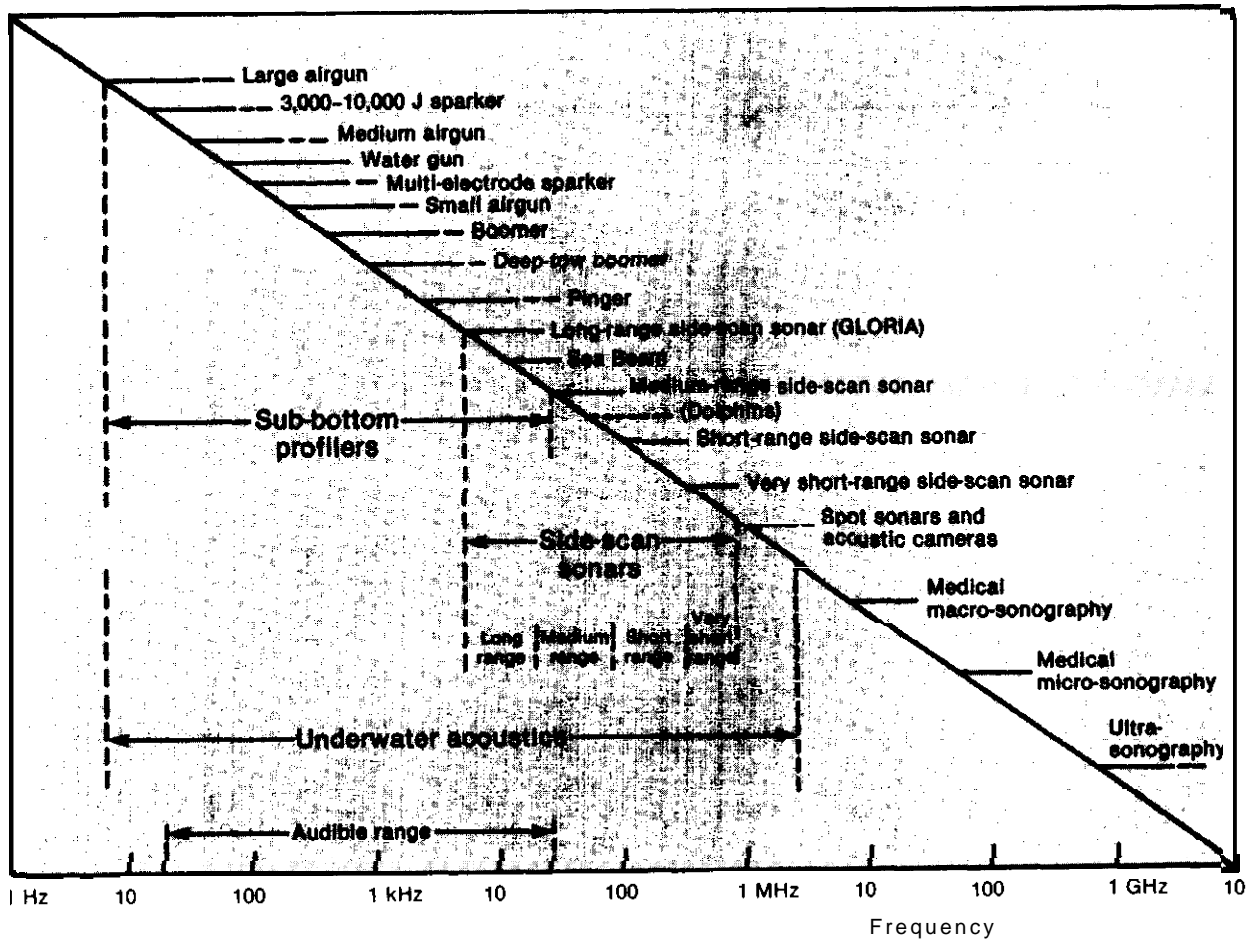

SOURCE: B.W. Flemming, "A Historical Introduction to Underwater Acoustics, With Special Reference to Echo Sounding, Sub-bottom Profiling, and Side Scan Sonar," in W.G.A. Russell-Cargill (ed.), *Recent Developments in SideScan Sonar Techniques* (Capetown, South Africa: ABC Press, Ltd., 1982).

range in frequency from about 5 hertz to 1 kilohertz. The systems with sound frequencies in this range are very useful to the oil and gas industry. Most often these are expensive multi-channel systems. Since most mineral deposits of potential economic interest are on or near the surface of the seabed, deep penetration systems have limited usefulness for mineral exploration. Seismic systems most often used for offshore mineral exploration are those that operate at acoustic frequencies between 1 and 14 kilohertz (typically 3.5 kilohertz). These systems, known as sub-bottom profilers, provide continuous high-resolution seismic profile recordings of the uppermost 30 meters of strata.³⁸

³⁸P. K. Trabant, *Applied High-Resolution Geophysical Methods: Offshore Geoengineering Hazards* (Boston, MA: International Human Resources Development Corp., 1984), p. 81.

Typically, they are single-channel systems. They can be operated at the same ship speeds as bathymetric and sonar systems. A few towed vehicles are equipped with both side-looking sonar and sub-bottom profiling capability using the same coaxial tow cable.³⁹

One drawback with single-channel systems is that they suffer from various kinds of multi-path and pulse reverberation problems, problems best handled by multi-channel systems. A 100 or 500 hertz multi-channel system is able to provide shallow penetration data while avoiding the problems of

³⁹C.J. Ingram, "High-Resolution Side-Scan Sonar/Subbottom Profiling to 6000M Water Depth," unpublished, presented at the Pacific Congress on Marine Technology, sponsored by Marine Technology Society, Hawaii Section, Honolulu, HA, Mar. 24-28, 1986.

Figure 4.9.—Seismic Reflection and Refraction Principles

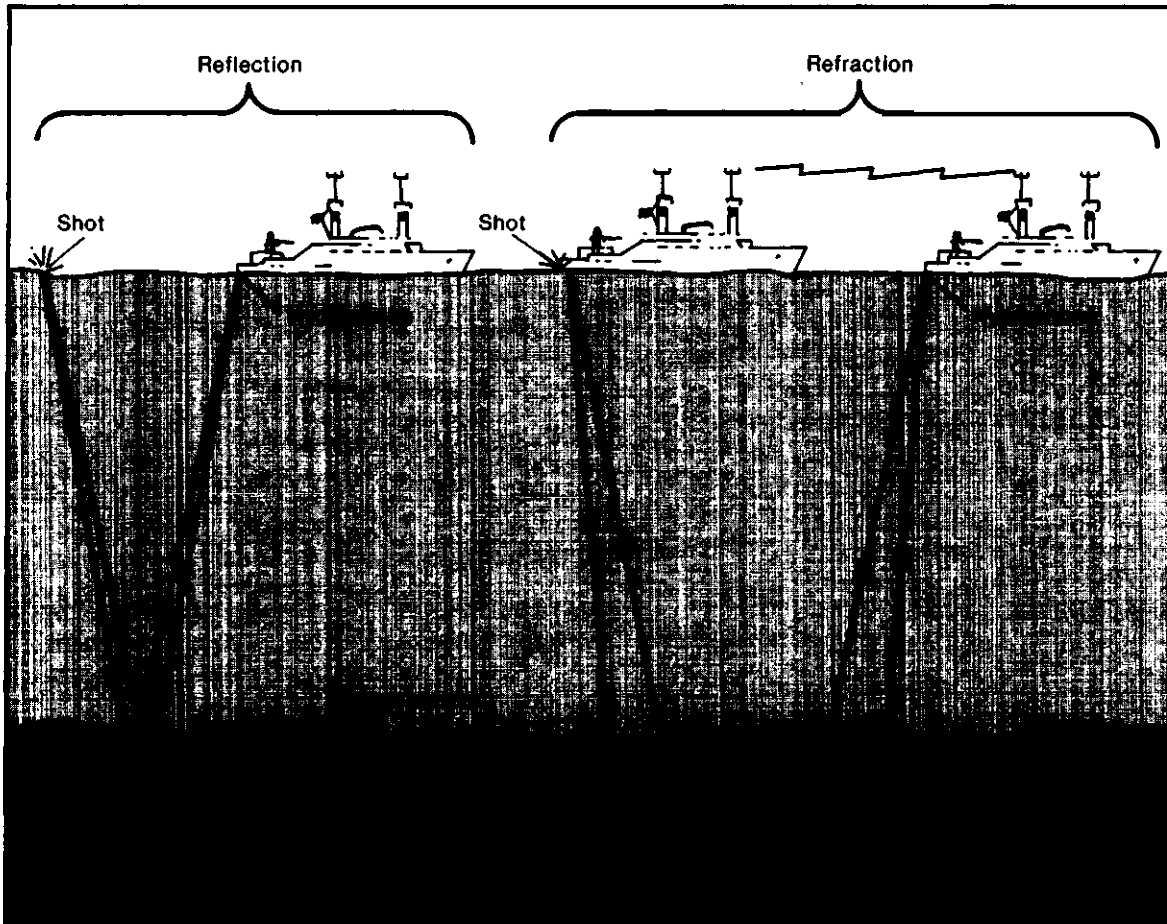

In the seismic reflection technique, sound waves from a source at a ship bounce directly back to the ship from sediment and rock layers. In the seismic refraction technique, the sound waves from a "shooting" ship travel along the sediment and rock layers before propagating back to a "receiving" ship.

SOURCE: P.A. Rena, *Exploration Methods for the Continental Shelf: Geology, Geophysics, Geochemistry*, NOAA Technical Report ERL 238-AOML 8 (Boulder, CO: National Oceanic and Atmospheric Administration, 1972), p. 15.

single-channel systems. Because of cost, however, a multi-channel system is usually not used for reconnaissance work.

High-resolution seismic reflection techniques are able to detect the presence of sediment layers or sand lenses as little as 1 meter thick. In addition, information about the specific type of material detected sometimes may be obtained by evaluating the acoustic velocity and frequency characteristics of the material. Seismic techniques may provide clues for locating thin, surficial deposits of manganese nodules or cobalt crusts, but side-looking

sonar is a better tool to use for this purpose. Ryan reports that a 1 to 5-kilohertz sub-bottom profiler was very effective in reconnaissance of sediment-hosted sulfides of the Juan de Fuca Ridge.⁴⁰ While seismic methods provide a cross-sectional view of stratigraphic and structural geologic framework, geologists prefer to supplement these methods with coring, sampling, and drilling (i. e., direct methods), with photography and submersible observa-

⁴⁰W. B. F. Ryan, Lamont-Doherty Geological Observatory, OTA Workshop on Technologies for Surveying and Exploring the Exclusive Economic Zone, Washington, DC, June 10, 1986.

Figure 4-10.—Seismic Record With Interpretation

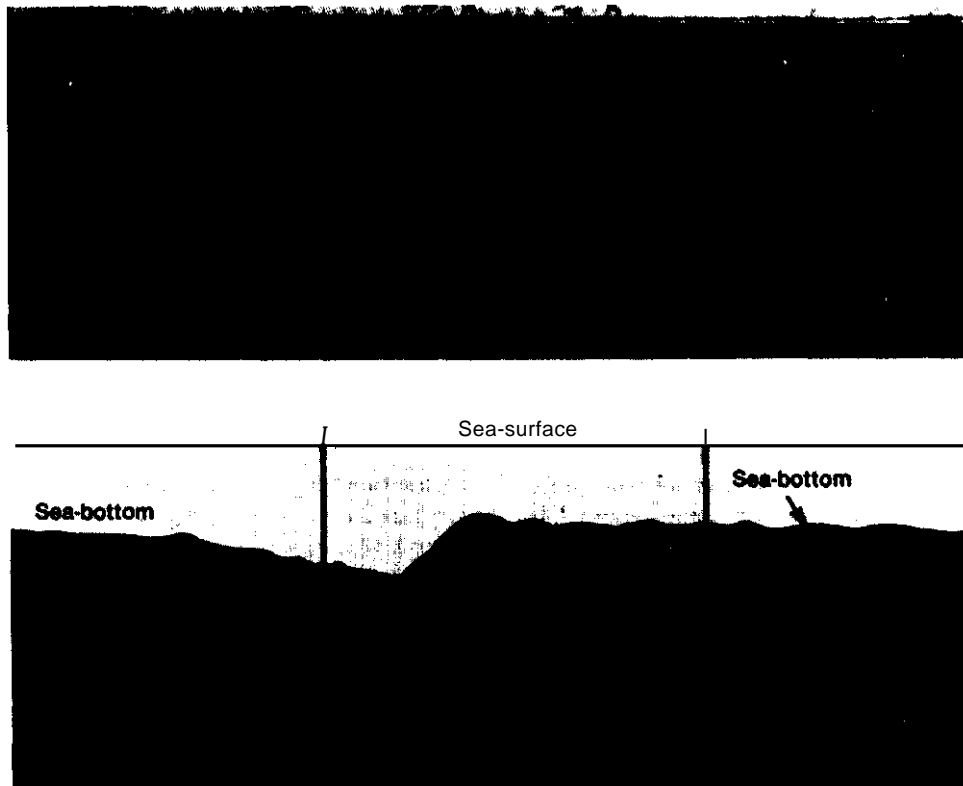

Academic and industry researchers interpret seismic records to help them determine geological structure and stratigraphy below the seabed.

SOURCE: U.S. Geological Survey.

tions, and with geochemical sampling of bottom sediments and of the water column, etc., for the highest quality interpretations.

Advances in reflection seismology have been made more or less continuously during the approximately 60 years since its invention.⁴¹ Recent technological innovations have been the development of three-dimensional (3-D) seismic surveying and interactive computer software for assisting interpretation of the mountains of 3-D data generated. To acquire enough data for 3-D work, survey lines are set very close together, about 25 to 100 meters apart. Data for the gaps between lines then can be interpolated. The efficiency of data acquisition can be increased by towing two separate streamers

⁴¹C. H. Savit, "The Accelerating Pace of Geophysical Technology," *Oceans 84 Conference Record*, Sponsored by Marine Technology Society and IEEE Ocean Engineering Society, Sept. 10-12, 1984, (Washington, D. C.: Marine Technology Society, 1984), pp. 87-89.

(and technical advances will soon enable two lines of profile to be acquired from each of two separate cables).⁴²

Interactive programs allow the viewer to look at consecutive cross-sections of a 3-D seismic profile or at any part of it in horizontal display. Thus, if desired, the computer can strip away everything but the layer under study and look at this layer at any angle. Moreover, the surveyed block can be cut along a fault line, and one side can be slid along the other until a match is made. Interpretation of data can be accomplished much faster than on paper. Such systems are expensive. While the cost of acquiring and processing 20 kilometers of two-dimensional seismic data may be from \$500 to \$2,000 per kilometer, a 3-D high-density survey

⁴²Savit, OTA Workshop, June 10, 1986.

of a 10-by 20-kilometer area could cost on the order of \$3 million.

Resolution also continues to improve, assisted by better navigation, positioning, and control methods. An innovation which promises to further improve resolution is the use of chirp signals rather than sound pulses. Chirp signals are oscillating signals in which frequency is continuously varying. Using computer-generated chirp signals, it is possible to tailor and control emitted frequencies. In contrast, pulse sources produce essentially uncontrolled frequencies, generating both useful and unneeded frequencies at the same time.

About 10 million miles of seismic profiles have been run in the U.S. EEZ. Most of these data are deep penetration profiles produced by companies searching for oil and are therefore proprietary. The Minerals Management Service within the U.S. Department of the Interior (MMS) purchases about 15 percent of the data produced by industry, most of the data are held for 10 years and then turned over to the National Geophysical Data Center. NGDC archives about 4 million miles of public (mostly academic) seismic data. Much of this data is for regions outside the EEZ. NGDC also archives USGS data, most of which are from the EEZ (see ch. 7).

It is possible to acquire shallow-penetration seismic information (as well as magnetic and gravity data) at the same time as bathymetric data, so that surface features can be related to vertical structure and other characteristics of a deposit. NOAA acknowledges that simultaneous collection of different types of data could be accomplished easily aboard its survey ships. Additional costs would not be significant relative to the cost of operating the ships, but would be significant relative to currently available funds. The agency would like to collect this data simultaneously if funds were available. NOAA hopes to interest academia and the private sector, perhaps with USGS help, to form a consortium to coordinate and manage the gathering of seismic and other data, using ships of opportunity.⁴³ The offshore seismic firms serving the oil and gas industry are opposed to any publicly funded

data acquisition that could deprive them of business opportunities. All but very shallow penetration data generally are of interest to the petroleum industry and therefore could be considered competitive with private sector service companies.

Magnetic Methods

Some marine sediments and rocks (as well as sunken ships, pipelines, oil platforms, etc.) contain iron-rich minerals with magnetic properties. Magnetic methods can detect and characterize these magnetic materials and other features by measuring differences (or anomalies) in the geomagnetic field. Magnetic (and gravity) techniques are inherently reconnaissance tools, since the data produced must be compiled over fairly broad areas to detect trends in the composition and structure of rock. However, spatial resolution, or the ability to detect increasingly fine detail, varies depending on the design of the sensor, the spacing of survey lines, and the distance of the sensor from the source of anomaly.

Satellite surveys are able to detect magnetic anomalies on a global or near-global scale. Satellite data are important for detecting global or continental structural trends of limited value to resource exploration. At such broad scale, mineral deposits would not be detected. Airplane and ship surveys record finer scale data for smaller regions than satellites, enabling specific structures to be detected. The closer the sensor to the structure being sensed, the better the resolution, but the time required to collect the data, as well as the cost to do so, increases proportionately.

Regional magnetic surveys, usually done by airplane, can detect the regional geologic pattern, the magnetic character of different rock groups, and major structural features which would not be noted if the survey covered only a limited area.⁴⁴ For example, oceanic rifts, the transition between continental and oceanic crusts, volcanic structures, and major faults have been examined at this scale. Regional magnetic surveys also have been used extensively in exploring for hydrocarbons. Accurate measurement of magnetic anomalies can help ge-

⁴³C. Anderson, NOAA EEZ project manager, interview by W. Westermeyer at NOAA, Rockville, MD, Apr. 22, 1986.

⁴⁴P. V. Sharma, *Geophysical Methods in Geology* (New York, NY: Elsevier Science Publishing Co., 1976), p. 228.

ophysicists delineate geologic structures associated with petroleum and measure the thickness of sediments above magnetic basement rocks .45

Surveys also may be conducted to locate concentrations of ferromagnetic minerals on or beneath the seafloor. The detection of magnetite may be particularly important in mineral prospecting because it is often found in association with ilmenite and other heavy minerals. Ilmenite also contains iron, but it is much less strongly magnetized than the magnetite with which it is associated (it also may have weathered during low stands of sea level and may have lost magnetic susceptibility).

The precise location of a mineral deposit or other object may require a more detailed survey than is possible by satellite or airplane. Use of ship-towed magnetometers has met with varying measures of success in identifying placer deposits. Improvements in sensitivity are needed. If enough data are gathered to determine the shape and amplitude of a local anomaly, the size of an iron-bearing body and its trend can be estimated, a common practice on land. When magnetic information can be correlated with other types of information (e. g., bathymetric, seismic, and gravity) interpretation is enhanced.

Magnetic anomalies also can be used to locate and study zones of alteration of the oceanic crust. The initial magnetization of the oceanic crust is acquired as it cools from a magma to solid rock. For the next 5 to 10 million years, hydrothermal circulation promotes the alteration of this igneous rock and the generation of new secondary minerals. Initially, the heat of hydrothermal circulation destroys the thermal remanent magnetization. Rona suggests that this reduction in magnetization will produce a magnetic anomaly and signal the proximity of active or inactive smokers or hydrothermal vents. ⁴⁶The Deep Sea Drilling project and Ocean Drilling Program drilling results suggest that as the secondary minerals grow, they acquire the magnetization of the ambient magnetic field. This aggregate magnetization produces a signature which

is detectable on a regional scale and might be used to determine the degree and rate of regional alteration. 47

Variations in the intensity of magnetization (total field variations) are detected using a magnetometer. Magnetometers deployed from ships or airplanes are either towed behind or mounted at an extreme point to minimize the effect of the vessel's magnetic field. Among the several types of magnetometers, proton precession and flux-gate types are most often used. These magnetometers are relatively simple to operate, have no moving parts, and provide relatively high-resolution measurements in the field. The technology for sensing magnetic anomalies is considered mature. A new helium-pumped magnetometer with significantly improved sensitivity has been developed by Texas Instruments and is being adapted to oceanographic work.

Most magnetic measurements are total field measurements. A modification of this technique is to use a second sensor to measure the difference in the total field between two points rather than the total field at any given point. Use of this gradiometry technique helps eliminate some of the external noise associated with platform motion or external field variation (e. g., the daily variation in the magnetic field). This is possible because sensors (if in close enough proximity) measure the same errors in the total field, which are then eliminated in determining the total field difference between the two points. Gradiometry improves sensitivity to closer magnetic sources .⁴⁸

The most important problem in acquiring high-quality data at sea is not technology but accurate navigation. The Global Positioning System, when available, is considered more than adequate fine navigation and positioning needs. Future data, to be most useful for mineral exploration purposes, will necessarily need to be collected as densely as possible. It is also important that magnetic (and gravity) data be recorded in a manner that minimizes the effects of external sources, such as of the towing platform, and that whatever data are meas-

⁴⁵P. A. Rona, "Exploration Methods for the Continental Shelf: Geology, Geophysics, Geochemistry, NOAA Technical Report, F. RI. 238-AOML 8 (Boulder, CO: NOAA, 1972), p. 22.

⁴⁶Rona, "Exploration for Hydrothermal Mineral Deposits at Seafloor Spreading Centers," p. 25.

⁴⁷J. L. LaBrecque, Lament-Doherty Geological Observatory, OTA, May 1, 1987.

⁴⁸J. Brozena, Naval Research Laboratory, and J. LaBrecque, Lament-Doherty Geological Observatory, OTA Workshop on Technologies for Surveying and Exploring the Exclusive Economic Zone, Washington, DC, June 10, 1986.

ured be incorporated into larger data sets, so that data at different scales are simultaneously available to investigators.

Gravity Methods

Like magnetic methods, the aim of gravity methods is to locate anomalies caused by changes in physical properties of rocks.⁴⁹ The anomalies sought are variations in the Earth's gravitational field resulting from differences in density of rocks in the crust—the difference between the normal or expected gravity at a given point and the measured gravity. The instrument used for conducting total field gravity surveys is a gravimeter, which is a well-tested and proven instrument. Techniques for conducting gradiometric surveys are being developed by the Department of Defense, although these will be used for classified defense projects and will not be available for public use.⁵⁰

The end product of a gravity survey is usually a contoured anomaly map, showing a plane view or cross-section. The form in which gravity, as well as magnetic, data is presented differs from that for seismic data in that the fields observed are integrations of contributions from all depths rather than a distinct record of information at various depths. Geophysicists use such anomaly characteristics as amplitude, shape, and gradient to deduce the location and form of the structure that produces the gravity disturbance.⁵¹ For example, low-density features such as salt domes, sedimentary infill in basins, and granite appear as gravity “lows” because they are not as dense as basalt and ore bodies, which appear as gravity “highs. Interpretation of gravity data, however, is generally not straightforward, as there are usually many possible explanations for any given anomaly. Usually, gravity data are acquired and analyzed together with seismic, magnetic, and other data, each contributing different information about the sub-bottom geological framework.

Since variations in terrain fleet the force of gravity, terrain corrections must be applied to gravity

data to produce an accurate picture of the structure and physical properties of rocks. Bathymetric data are used for this purpose; however, terrain corrections using existing bathymetry data are relatively crude. Terrain corrections using data produced by swath mapping techniques provide a much improved adjustment.

Like magnetic data, the acquisition of gravity data may be from satellite, aircraft, or ship. The way to measure the broadest scale of gravity is from a satellite. SEASAT, for instance, has provided very broad-scale measurements of the geoid (surface of constant gravitational potential) for all the world's oceans. To date, almost all gravity coverage of the EEZ has been acquired by ship-borne gravimeters. Gravimetry technology and interpretation techniques are now considered mature for ship-borne systems. However, the quality of ship-based gravity data more than 10 years old is poor. Airborne gravimetry is relatively new, and technology for airborne gravity surveys (both total field and gravity gradient types) is still being refined. As airborne gravity technology is further developed, it can be expected that this much faster and more economical method of gathering data will be used.

Of all the techniques useful for hard mineral reconnaissance, however, gravity techniques are probably the least useful. This is because it is very difficult to determine variations in structure for shallow features (e. g., 200 meters or less). Shallow material is all about the same density, and excess noise reduces resolution. Gravity techniques are used primarily for investigating intermediate-to-deep structures—the structure of the basement and the transition between continental and oceanic crust. Many of these structures are of interest to the oil industry. Although large faults, basins, or seamounts may be detected with air- or ship-borne gravimeters, it is unlikely that shallow placer deposits also could be located using this technique.

USGS has published gravity maps of the Atlantic coast, the Gulf of Mexico, central and southern offshore California, the Gulf of Alaska, and the Bering Sea. However, little of the EEZ has been mapped in detail, and coverage is very spotty. For example, port areas appear to be well-surveyed, but density of track lines decreases quickly with distance from port. Oil companies have done the most grav-

⁴⁹Sharma, *Geophysical Methods in Geology*, p.88.

⁵⁰J. Brozena, Naval Research Laboratory, OTA Workshop on Technologies for Surveying and Exploring the Exclusive Economic Zone, Washington, DC, June 10, 1986.

⁵¹Sharma, *Geophysical Methods in Geology*, p.131.

ity surveying, but the information they hold is proprietary. Little surveying has been done in very shallow waters (i. e., less than 10 meters), as the larger survey ships cannot operate in these waters.

The availability of high-density gravity data (and possibly also magnetic data) for extensive areas of the EEZ may pose a security problem similar to that posed by high-resolution bathymetry. Gravitational

variations affect inertial guidance systems and flight trajectories. The Department of Defense has concerns about proposals to undertake systematic EEZ gravity surveys, particularly if done in conjunction with the systematic collection of bathymetry data, since characteristic subsea features might be used for positioning missile-bearing submarines for strikes on the United States.

SITE-SPECIFIC TECHNOLOGIES

Site-specific exploration technologies generally are those that obtain data from small areas relative to information provided by reconnaissance techniques. Some of these technologies are deployed from a stationary ship or other stationary platform and are used to acquire detailed information at a specific site. Often, in fact, such techniques as coring, drilling, and grab sampling are used to verify data obtained from reconnaissance methods. Other site-specific technologies are used aboard ships moving at slow speeds. Electrical and nuclear techniques are in this category.

Electrical Techniques

Electrical prospecting methods have been used extensively on land to search for metals and minerals, but their use offshore, particularly as applied to the shallow targets of interest to marine miners, is only just beginning. Recent experiments by researchers in the United States and Canada suggest that some electrical techniques used successfully on land may be adaptable for use in marine mineral exploration.⁵⁷ Like other indirect exploration techniques, the results of electrical methods usually can be interpreted in various ways, so the more independent lines of evidence that can be marshaled in making an interpretation, the better.

The aim of electrical techniques is to deduce information about the nature of materials in the earth based on electrical properties such as conductivity,

electrochemical activity, and the capacity of rock to store an electric charge. Electrical techniques are similar to gravity and magnetic techniques in that they are used to detect anomalies—in this case, anomalies in resistivity, conductivity, etc. , which allow inferences to be made about the nature of the material being studied.

The use of electrical methods in the ocean is very different from their use on land. One reason is that seawater is generally much more conductive than the underlying rock, the opposite of the situation on land where the underlying rock is more conductive than the atmosphere. Hence, working at sea using a controlled-source electromagnetic method is somewhat analogous to working on land and trying to determine the electrical characteristics of the atmosphere. In both cases, one would be looking at the resistive medium in a conductive environment. The fact that seawater is more conductive than rock appeared to preclude the use of electrical techniques at sea. Improvements in instrumentation and different approaches, however, have overcome this difficulty to a degree. A difference which benefits the use of electrical techniques at sea is that the marine environment is considerably quieter electrically than the terrestrial environment. Thus, working in a low-noise environment, it is possible to use much higher gain amplifiers, and it is usually not necessary to provide the noise shielding that would be needed on land. Also, coupling to the seafloor environment for both source and receiver electrodes is excellent. Thus, electrode resistances on the seafloor are typically less than 1 ohm, whereas on land the resistance would be on the order of 1,000 ohms.

Electrical techniques that may be useful for marine mineral prospecting include electromagnetic

⁵⁷A.D.Chave, S.C.Coustable, and R.N. Edwards, "Electrical Exploration Methods for the Seafloor," in press, 1987. See also S.Cheesman, R.N. Edwards, and A.D.Chave, "On the Theory of Seafloor Conductivity Mapping Using Transient EM Systems," *Geophysics*, February 1987; and J.C. Wynn, "Titanium Geophysics—A Marine Application of Induced Polarization," unpublished draft, 1987.

methods, direct current (DC) resistivity, self potential, and induced polarization.

Electromagnetic Methods

Electromagnetic (EM) methods detect variations in the conductive properties of rock. A current is induced in the conducting earth using electric or magnetic dipole sources. The electric or magnetic signature of the current is detected and yields a measure of the electrical conductivity of the underlying rock. The Horizontal Electric Dipole and the Vertical Electric Dipole method are two controlled-source EM systems that have been used in academic studies of deep structure. Both systems are undergoing further development. Recent work suggests that these techniques may enable researchers to determine the thickness of hydrothermal sulfide deposits, of which little is currently known. Changes in porosity with depth are also detectable.⁵³ To date, little work has been done regarding the potential applicability of these techniques for identifying marine placers.

Researchers at Scripps Institution of Oceanography are currently developing the towed, frequency domain Horizontal Electric Dipole method for exploration of the upper 100 meters of the seabed. A previous version of this system consists of a towed silver/silver-chloride transmitting antenna and a series of horizontal electric field receivers placed on the seafloor at ranges of 1 to 70 kilometers from the transmitter. Since this arrangement is not very practical for exploratory purposes, the Scripps researchers are now developing a system in which the transmitter and receiver can be towed in tandem along the bottom. Since the system must be towed on the seabed, an armored, insulated cable is used. The need for contact with the ocean floor limits the speed at which the system can be towed to 1 to 2 knots and the type of topography in which it can be used; hence, this method, like other electrical techniques, would be most efficiently employed after reconnaissance methods have been used to locate areas of special interest.

⁵³P.A. Wolfgram, R.N. Edwards, L. K. Law, and M. N. Bone, "Polymetallic Sulfide Exploration on the Deep Seafloor: The Mini-Moses Experiment," *Geophysics* 51, 1986, pp. 1808-1818.

The Vertical Electric Dipole method is being developed by researchers at Canada's Pacific Geoscience Center and the University of Toronto. The Canadian system is known as MOSES, short for magnetometric offshore electrical sounding. It consists of a vertical electric dipole which extends from the sea surface to the seafloor and a magnetometer receiver which measures the azimuthal magnetic field generated by the source.⁵⁴ The receiver is fixed to the seafloor and remains in place while a ship moves the transmitter to different locations. A MOSES survey was conducted in 1984 at two sites in the sediment-filled Middle Valley along the northern Juan de Fuca Ridge. Using MOSES, researchers estimated sediment and underlying basalt resistivity, thickness, and porosity.

Another electromagnetic method with some promise is the Transient EM Method. Unlike controlled source methods in which a sinusoidal signal is generated, a source transmitter is turned on or off so that the response to this "transient" can be studied. An advantage of the Transient EM method is that the effects of shallow and deep structure tend to appear at discrete times, so it is possible to separate their effects. Also, the effects of topography, which are difficult to interpret, can be removed, allowing researchers to study the underlying structure. The Transient EM method also may be particularly useful for locating sulfides, since they have a high conductivity relative to surrounding rock and are located in ragged areas of the seafloor. A prototype Transient EM system is currently being designed for survey purposes. It will use a horizontal magnetic dipole source and receiver and will be towed along the seafloor.⁵⁵

Direct Current Resistivity

Resistivity is a measure of the amount of current that passes through a substance when a specified potential difference is applied. The direct current resistivity method is one of the simplest electrical techniques available and has been used extensively on land to map boundaries between

⁵⁴D.c.Nobes, L.K. Law, and R.N. Edwards, "The Determination of Resistivity and Porosity of the Sediment and Fractured Basalt Layers Near the Juan de Fuca Ridge," *Geophysical Journal of the Royal Astronomical Society* 86, 1986, pp. 289-318.

⁵⁵Cheesman, Edwards, and Chave, "On the Theory of Seafloor Conductivity Mapping."

layers having different conductivities.⁵⁶ Recent marine DC resistivity experiments suggest that the DC resistivity method may have applications for locating and delineating sulfide ore bodies. For example, during one experiment at the East Pacific Rise in 1984, substantial resistivity anomalies were detected around known hydrothermal fields, and seafloor conductivities were observed that were twice that of seawater.⁵⁷ In this experiment the source and receiver electrodes were towed from a research submersible. Conversely, resistivity techniques would not be expected to detect placer deposits, except under the most unusual circumstances. This is because seawater dominates the resistivity response of marine sediments (as they are saturated near the surface), and, in this case, only the relative compaction (porosity) of the sediments could be measured.⁵⁸

Self Potential

The self potential (or spontaneous polarization) (SP) method is used to detect electrochemical effects caused by the presence of an ore body. The origin of SP fields is uncertain, but it is believed that they result from the electric currents that are produced when a conducting body connects regions of different electrochemical potential.⁵⁹ On land, SP has been used primarily in the search for sulfide mineral deposits. It is a simple technique in that it does not involve the application of external electric fields. However, its use offshore has been limited. Results of some experiments have been inconclusive, but the offshore extension of known land sulfide deposits was successfully detected in a 1977 experiment.⁶⁰ More recently, researchers at the University of Washington have proposed building a towed SP system for exploring the Juan de Fuca Ridge. SP may prove effective for detecting the presence of sulfide deposits; however, it is unlikely to be of help in assessing the size of deposits.

⁵⁶M. B. Dobrin, *Introduction to Geophysical prospecting* (New York, NY: McGraw-Hill Book Co., 1976), p. 6.

⁵⁷T. J. G. Francis, "Resistivity Measurements of an Ocean Floor Sulfide Mineral Deposit From the Submersible *Cyana*," *Marine Geophysical Research* 7, 1985, pp. 419-438.

⁵⁸J. Wynn, U.S. Geological Survey, letter to W. Westermeyer, OTA, May 1986.

⁵⁹Chave, Coustable, and Edwards, "Electrical Exploration Methods for the Seafloor.

⁶⁰Ibid.

Induced Polarization

The induced polarization (1P) method has been used for years to locate disseminated sulfide minerals on land. Recent work by USGS to adapt the technique for use as a reconnaissance tool to search for offshore titanium placers (figure 4-11) has produced some promising preliminary results. The 1P effect can be measured in several ways, but, in all cases, two electrodes are used to introduce current into the ground, setting up an electric potential field. Two additional electrodes are used, usually spaced some distance away, to detect the 1P effect. This effect is caused by ions under the influence of the potential field moving from the surrounding electrolyte (groundwater onshore, seawater in the seabed sediments) onto local mineral-grain interfaces and being adsorbed there. When the potential field is suddenly shut off, there is a finite decay time when these ions bleed back into the electrolyte, similar to a capacitor in an electric circuit.

If perfected for offshore use, the reconnaissance mode of 1P may enable investigators to determine if polarizable minerals are present, although not precisely what kind they are (although ilmenite and some base metal sulfides, especially pyrite and chalcopyrite, have a significant 1P effect, so do certain clays and sometimes graphite). In the reconnaissance mode, the 1P streamer can be towed from a ship; as seawater is highly conductive, it is not necessary to implant the 1P electrodes on the seafloor. Consequently, it is "theoretically possible to cover more terrain with 1P measurements in a week offshore than has been done onshore by geophysicists worldwide in the last 30 years."⁶¹ Best results are produced when the electrodes are towed 1 to 2 meters off the bottom (although before 1P exploration becomes routine, a better cable depressor and more abrasion-resistant cables will have to be developed). Electrodes spaced 10 meters apart enable penetration of sediments to a depth of about 7 meters. The current USGS system is designed to work in maximum water depths of 100 meters.

⁶¹J. C. Wynn and A.E. Grosz, "Application of the Induced Polarization Method to Offshore Placer Resource Exploration," *Proceedings, Offshore Technology Conference* 86, May 5-8, 1986, Houston, TX, OTC 5199, pp. 395-401.

Figure 4-11.—Conceptual Design of the Towed-Cable-Array Induced Polarization System

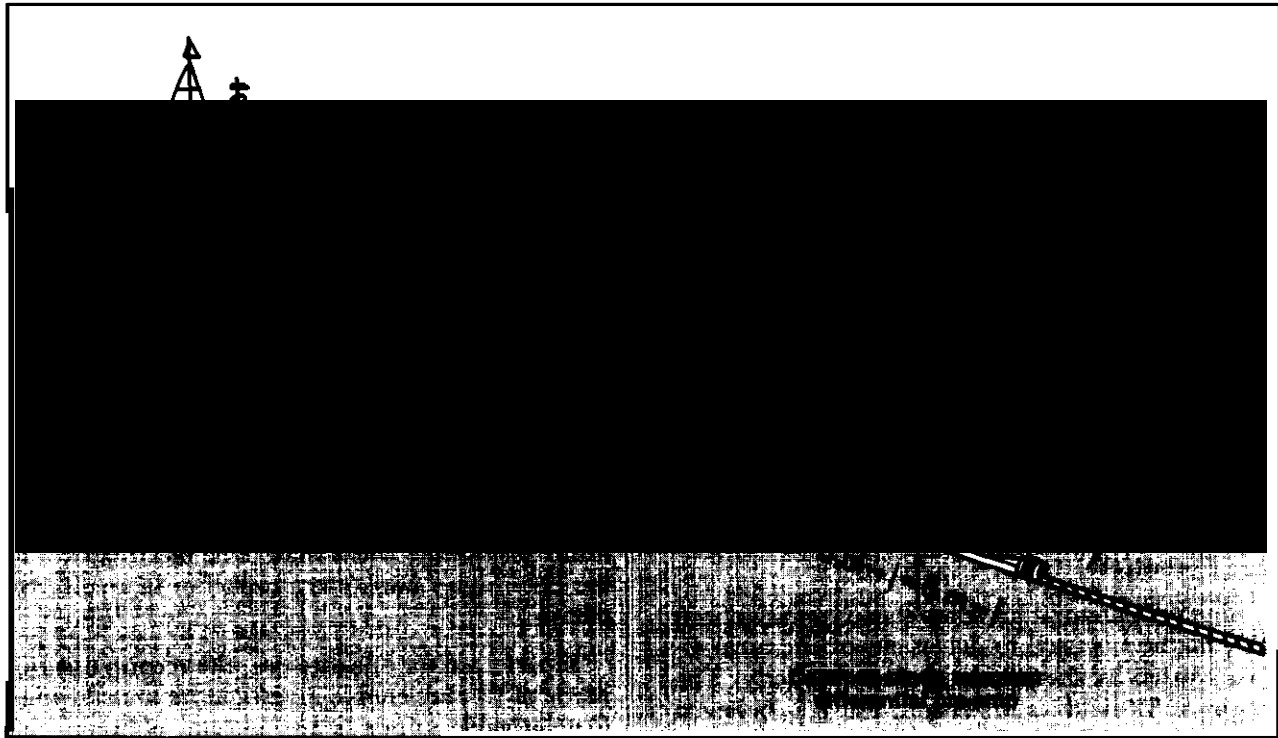

Induced polarization, used for many years onshore, is currently being adapted for use at sea to search for titanium placers.

SOURCE: J.C. Wynn and A.E. Grosz, "Application of the Induced Polarization Method to Offshore Placer Resource Exploration," *Proceedings, Offshore Technology Conference S6*, May 5-8, 1986, Houston, TX (OTC 5199), p. 399.

When polarizable minerals are located, there is some hope that a related method, spectral induced polarization (which requires a stationary ship), may be able to discriminate between the various sources of the 1P effect. It has been demonstrated that certain onshore titanium minerals (e. g., ilmenite and altered ilmenite) have strong and distinctive 1P signatures, and that these signatures can be used in the field for estimating volumes and percentages of these minerals.⁶² One factor complicating interpretation of the spectral 1P signature for ilmenite could be the degree of weathering. More work is required to determine if spectral 1P works as well offshore as it does onshore. If so, it may be possible to survey large areas of the EEZ using recon-

naissance and spectral 1P. Sampling then could be guided in a much more efficient manner.⁶³

The applicability of 1P to placers other than titanium-bearing sands has not been demonstrated, but USGS researchers also believe that it may be possible, by recalibrating 1P equipment, to identify and quantify other mineral sands. Experiments are now being designed to determine if 1P methods can be used to identify gold and platinum sands.⁶⁴ The applicability of 1P techniques to marine sulfide deposits and to manganese-cobalt crusts, too, has yet to be demonstrated. USGS researchers hope to acquire samples of both types of deposits to perform the necessary laboratory measurements.

⁶²J.C. Wynn, A. E. Grosz, and V. M. Fosc, "Induced Polarization Response of Titanium-Bearing Placer Deposits in the Southeastern United States," Open-File Report 85-756 (Washington, DC: U.S. Geological Survey, 1985).

⁶³Wynn and Grosz, "Applications of the Induced Polarization Method," p. 397.

⁶⁴A. Grosz Eastern Mineral Resources, USGS, telephone conversation with W. Westermeyer, OTA, Apr. 8, 1986.

Induced Polarization for Core Analysis

Another interesting possibility now being investigated is to use 1P at sea to assay full-length vibracore samples. Many techniques can assist geologists and mineral prospectors in identifying promising areas for mineral accumulations. Nevertheless, to determine precisely what minerals are present and in what quantities, it is still necessary to do laborious, expensive site-specific coring. Moreover, once a core is obtained, it often takes many hours to analyze its constituents, and much of this work must be done in shore-based laboratories.

To explore a prospective offshore mine site thoroughly, hundreds or even thousands of core samples would be needed. Geologists need analytical methods that would enable them to quickly identify and characterize deposits. USGS researchers have begun to insert 1P electrodes into unopened vibracores to determine the identity and proportion of polarizable minerals present. Such a procedure can be done in about 20 minutes and can therefore save considerable time and expense. If the analysis showed interesting results, the ship could immediately proceed with more detailed coring (shore-based analysis of cores precludes revisiting promising sites on the same voyage).

Geochemical Techniques

Water Sampling

Measurement of geochemical properties of the water column is a useful exploration method for detecting sulfide-bearing hydrothermal discharges at active ridge crests.⁶⁵ Some techniques have been developed for detecting geochemical anomalies in the water column 500 kilometers (310 miles) or more from active vent sites. Used in combination with geophysical and geological methods, these techniques help researchers “zero in” on hydrothermal discharges. Other geochemical methods are used to sense water column properties in the immediate vicinity of active vent sites.

Reconnaissance techniques include water sampling for particulate metals, elevated values of dissolved manganese, and the helium-3 isotope. Iron and manganese adsorbed on weak acid-soluble par-

ticulate matter have been detected 750 kilometers (465 miles) from the vent from which they were issued. Total dissolvable manganese is detectable several tens of kilometers from active hydrothermal sources. Methane, which is discharged as a dissolved gas from active vent systems, can be detected on the order of several kilometers from a vent site.⁶⁶ Analysis of water samples for methane has the advantage that it can be done aboard ship in less than an hour. Analysis for total dissolvable manganese requires about 10 hours of shipboard time.

At a distance of 1 kilometer or less from an active vent, the radon-222 isotope and dissolved metals also may be detected. The radon isotope produced by uranium series decay in basalt, reaches the seafloor through hydrothermal circulation and can be sampled close to an active vent. Helium-3 derived from degassing of the mantle beneath oceanic crust and entrained in subseafloor hydrothermal convection systems may be detectable in the vicinity of active vents. Other near-field water column measurements which may provide evidence of the proximity of active vents include measurements of light scattering due to suspended particulate matter, temperature, thermal conductivity, and salinity. Light scattering and temperature observations proved to be very useful in identifying hydrothermal plumes along the southern Juan de Fuca Ridge.⁶⁷

Geochemical properties of the water column are measured using both deep-towed instrument packages and “on-station” sampling techniques. For example, NOAA’s deep-towed instrumented sled, SLEUTH has been used to systematically survey portions of the Juan de Fuca Ridge. Measurements made by SLEUTH sensors over the ridge crest were supplemented by on-station measurements up to 100 kilometers off the ridge axis.⁶⁸ Similar surveys have been made over the Mid-Atlantic Ridge⁶⁹ and elsewhere. The sensitivity and precision of instruments used to acquire geochemical information continues to improve. Perhaps as importantly,

⁶⁵Ibid.

⁶⁷E. T. Baker, J. W. Lavelle, and G. J. Massoth, “Hydrothermal Particle Plumes Over the Southern Juan de Fuca Ridge,” *Nature*, vol. 316, July 25, 1985, p. 342.

⁶⁸Ibid.

⁶⁹P. A. Ron, G. Klinkhammer, T. A. Nelsen, J. H. Trefey, and H. Elderfield, “Black Smokers, Massive Sulfides, and Vent Biota at the Mid-Atlantic Ridge,” *Nature*, vol. 321, May 1, 1986, p. 33.

⁶⁵Rona, “Exploration for Hydrothermal Mineral Deposits, pp. 7-37.

towed instrument packages like SLEUTH are enabling systematic surveys of large ocean areas to be undertaken.

Nuclear Methods

Nuclear methods consist of physical techniques for studying the nuclear or radioactive reactions and properties of substances. Several systems have been developed to detect the radiation given off by such minerals as phosphorite, monazite, and zircon. One such device was developed by the Center for Applied Isotope Studies (CAIS) at the University of Georgia. In the mid-1970s, the Center developed an underwater sled equipped with a radiation detector that is pulled at about 3 knots over relatively flat seabed terrain. The towed device consists of a four-channel analyzer that detects potassium-40, bismuth-214, thallium-208, and total radiation. The sled has been used to locate phosphorite off the coast of Georgia by detecting bismuth-214, one of the radioactive daughters of uranium, often a constituent of phosphorite. In another area offshore Georgia, the Center's towed sled detected thallium-208, an indicator of certain heavy minerals. Subsequent acquisition of surficial samples (grab samples) of the area confirmed the presence of heavy mineral sands.⁷⁰

A similar system for detecting minerals associated with radioactive elements has been developed by Harwell Laboratory in the United Kingdom. The Harwell system identifies and measures three principal elements: uranium, thorium, and potassium. The seabed probe resembles a snake and is towed at about 4 knots in water depths up to 400 meters (1,300 feet). The Harwell system is now commercially available and is being offered by British Oceanics, Ltd., as part of its worldwide survey services.⁷¹

A second type of nuclear technique with promise for widespread application in marine mineral exploration uses X-ray fluorescence to rapidly analyze surface sediments aboard a moving ship. The method was developed by CAIS and uses X-ray fluorescence as the final step. X-ray fluorescence

is a routine method used in chemical analyses of solids and liquids. A specimen to be analyzed using this technique is irradiated by an intense X-ray beam which causes the elements in the specimen to emit (i. e., fluoresce) their characteristic X-ray line spectra. The elements in the specimen may be identified by the wavelengths of their spectral lines.⁷²

The CAIS Continuous Seafloor Sediment Sampler was originally developed for NOAA's use in rapid sampling of heavy metal pollutants in near-shore marine sediments. A sled is pulled along the seafloor at about three knots. The sled disturbs the surficial sediments, creating a small sediment plume. The plume is sucked into a pump system within the sled and pulled to the surface as a slurry. The slurry is further processed, after which small portions are collected on a continuous filter paper. After the water is removed, a small cookie-like wafer remains on the paper (hence, the system is known as the "cookie maker"). 'Cookies' are coded for time, location, and sample number and can be made about every 30 seconds, which, at a ship speed of 3 knots, is about every 150 feet. An X-ray fluorescence unit is then used to analyze the samples. It is possible to analyze three or four elements aboard ship and approximately 40 elements in a shore-based laboratory. The system has been designed to operate in water 150 feet deep but could be redesigned to operate in deeper water.⁷³

The cookie maker can increase the speed of marine surveys. Not only are samples quickly obtained but preliminary analysis of the samples is available while the survey is still underway. Availability of real-time data that could be used for making shipboard decisions could significantly improve the efficiency of marine surveys. One current limitation is that samples are only obtainable from the top 3 or 4 centimeters of sediment. Researchers believe that some indication of underlying deposits may be obtained by sampling the surficial sediments, but further tests are needed to determine if the technique also can be used for evaluating the composition of deeper sediments.

⁷⁰J. Noakes, Center for Applied Isotope Studies, OTA Workshop on Site-Specific Technologies for Exploring the Exclusive Economic Zone, Washington, DC, July 16, 1986.

⁷¹"Radiometric Techniques for Marine Mineral Surveys," *World Dredging and Marine Construction*, Apr. 1, 1983, p. 208.

⁷²*Encyclopedia of Science and Technology*, 5th ed., (New York, NY: McGraw-Hill, 1982), p. 741.

⁷³J. Noakes, OTA Workshop on Site-Specific Technologies for Exploring the Exclusive Economic Zone, Washington, DC, July 16, 1986.

A third type of nuclear technique, neutron activation analysis, has been used with some success to evaluate the components of manganese nodules from the deep seafloor.⁷⁴ The technique consists of irradiating a sample with neutrons, using californium-252 as a source. Gamma rays that are emitted as a result of neutron interactions then can be analyzed. Ideally, the identification and quantification of elements can be inferred from the spectral intensities of gamma ray energies that are emitted by naturally occurring and neutron-activated radioisotopes.⁷⁵ Although the neutron activation technique can be used at sea to obtain chemical analyses of many substances, its use is limited by the difficulty of taking precise analytical weights at sea. The X-ray fluorescence method has proven both easier to use at sea and less expensive.

Manned Submersibles and Remotely Operated Vehicles

Both manned and remotely operated vehicles (ROVs) have been working in the EEZ for many years. One characteristic that all undersea vehicles

⁷⁴*Ibid.*

⁷⁵*A Borehole Probe for In Situ Neutron Activation Analysis*, Open File Report 132-85 (Washington, DC: U.S. Bureau of Mines, June 1984), p. 8.

share is the ability to provide the explorer with a direct visual or optical view of objects in real-time. Another common characteristic is that undersea vehicles operate at very slow speeds relative to surface-oriented techniques. Indeed, a great deal of the work for which undersea vehicles are designed is accomplished while remaining stationary to examine or sample an object with the vehicles manipulators. As a consequence, neither manned nor unmanned vehicles are cost-effective if they are employed in large area exploration. Their best application is in performing very detailed exploration of small areas or in investigating specific characteristics of an area.

All manned submersibles carry a crew of at least 1 and as many as 12, one of which is a pilot. Most of the many types of manned submersibles are battery-powered and free-swimming; others are tethered to a surface support craft from which they receive power and/or life support (tables 4-5 and 4-6). A typical untethered, battery-powered manned submersible is *Alvin* which carries a crew of three (one pilot; two observers); its maximum operating depth is 4,000 meters (13,000 feet).

ROVs are unmanned vehicle systems operated from a remote station, generally on the sea surface. There are five main categories of ROVs:

Table 4-5.—U.S. Non-Government Submersibles (Manned)

Vehicle	Date built	Length (ft)	Operating depth (ft)	Power supply	Crew/observers	Manipulators/viewports	Operators
Arms I, II, III and IV	1976-1978	8.5	3,000	Battery	1/1	3/Bow dome	Oceaneering International, Santa Barbara, CA
Auguste Piccard	1978	93.5	2,000	Battery	6/3	0/1	Chicago, Inc., Barrington, IL
Beaver	1968	24.0	2,700	Battery	1/4	1/Bow dome	International Underwater Contractors, City Island, NY, NY
Deep Quest	1967	39.9	8,000	Battery	2/2	2/2	Lockheed Missiles & Space, San Diego, CA
Delta	1982	15.0	1,000	Battery	1/1	1/19	Marfab, Torrance, CA
Diaphus	1974	19.8	1,200	Battery	1/1	1/Bow dome	Texas A & M University, College Station, TX
Jim (14 ea)	1974	-	1,500	Human	1/0	2/1	Oceaneering International, Houston, TX
Johnson-Sea-Link I & II	1971-1975	22.8	3,000	Battery	1/3	1/Panoramic	Harbor Branch Foundation, Ft. Pierce, FL
Mermaid II	1972	17.9	1,000	Battery	1/1	1/Bow dome	International Underwater Contractors, City Island, NY
Nekon B&C	1968-1972	15.0	1,000	Battery	1/1	1/Bow dome	Oceanworks, Long Beach, CA
Pioneer	1978	17.0	1,200	Battery	1/2	2/3	Martech International, Houston, TX
Pisces VI	1976	20.0	6,600	Battery	1/2	2/3	International Underwater Contractors, City Island, NY
Snooper	1969	14.5	1,000	Battery	1/1	1/10	Undersea Graphics, Inc., Torrance, CA
Makalii	1966	17.7	1,200	Battery	1/1	1/6	University of Hawaii, Honolulu, HI
Wasp	1977	-	2,000	Surface	1/10	2/Bow dome	Oceaneering International, Houston, TX

SOURCE: Busby Associates, Inc. Arlington, VA

Table 4-6.—Federally Owned and Operated Submersibles

Vessel	Date built	Length (ft)	Operating depth	Power supply	Crew/observers	Manipulators/view ports	Speed (kts) cruise/max	Endurance (hrs) cruise/max
UNOLS								
<i>Alvin</i>	1964	25	12,000	Battery	1/2	1/4	1/2	—
NOAA								
<i>Pisces V</i>	1973	20	4,900	Battery	1/2	2/3	0.5/2	6/2
NAVY								
<i>Sea Cliff</i>	1968	26	20,000	Battery	2/1	2/5	0.5/2.5	8/2
<i>Turtle</i>	1968	26	10,000	Battery	2/1	2/5	0.5/2.5	8/2
NR-1	1969	136	—	Nuclear	7/—	—	—	—

SOURCE: Busby Associates, Inc., Arlington, VA.

1. tethered, free-swimming vehicles (the most common);
2. towed vehicles;
3. bottom crawling vehicles;
4. structurally-reliant vehicles; and
5. autonomous or untethered vehicles.

For exploring the EEZ, two types of ROVs appear most appropriate: tethered, free-swimming vehicles and towed vehicles (table 4-7). A typical tethered, free-swimming ROV system is shown in figure 4-12. Typically, vehicles of this type carry one or more closed-circuit television cameras, lights, and, depending on their size, a variety of tools and monitoring/measuring instrumentation. Almost all of them receive electrical power from a surface support vessel and can maneuver in all directions using onboard thrusters.

Towed vehicles are connected by a cable to a surface ship. Most often these vehicles carry television cameras and still cameras. Lateral movement is



Photo credit: Office of Undersea Research, NOAA

The Submersible *Alvin* and the *At/antis* //. *Alvin* is an untethered, battery-powered manned submersible capable of operating in 13,000 feet of water.

Table 4-7.—U.S. Government Supported ROVs

Type	Depth (ft)	Operator
<i>Tethered fnw-swimming:</i>		
<i>Mini Rover</i>	328	U.S. Navy
<i>ADROV</i>	1,000	U.S. Navy
<i>Mini Rover MK II</i>	1,200	NOAA
<i>Pluto</i>	1,300	U.S. Navy
<i>Snoopy (2)</i>	1,500	U.S. Navy
<i>Recon IV (4)</i>	1,500	U.S. Navy
<i>Curv II (2)</i>	2,500	U.S. Navy
<i>URS-1</i>	3,000	U.S. Navy
<i>Super Scorpio (2)</i>	4,900	U.S. Navy
<i>Deep Drone</i>	5,400	U.S. Navy
<i>Curv III</i>	10,000	U.S. Navy
<i>Towed:</i>		
<i>Manta</i>	2,100	NOAA, NMFS
<i>Teleprobe</i>	20,000	U.S. Navy
<i>Deep Tow</i>	20,000	Scripps
<i>Argo/Jason</i>	20,000	Woods Hole
<i>ANGUS</i>	20,000	Woods Hole
<i>Katz Fish</i>	2,500	Lamont-Doherty
<i>STSS</i>	20,000	U.S. Navy
<i>Untethered:</i>		
<i>E a v e E a s t</i>	150	University of New Hampshire
<i>Eave West</i>	200	U.S. Navy
<i>SPURV 1</i>	12,000	University of Washington
<i>SPURV II</i>	5,000	University of Washington
<i>UFSS</i>	1,500	U.S. Navy

SOURCE: Busby Associates, Inc., Arlington, Virginia

generally attained by maneuvering the towing vessel, and depth is controlled by reeling in or reeling out cable from the surface. These vehicles are designed to operate within the water column and not on the bottom, but some have been designed and equipped to periodically scoop sediment samples from the bottom.

Advantages and Limitations

Manned submersibles, particularly in the industrial arena, have gradually given way to ROVs. The relatively few manned vehicles that have remained in service have done so because they offer a unique capability which ROVs have yet to dupli-

Figure 4-12.—A Tethered, Free-Swimming Remotely Operated Vehicle System

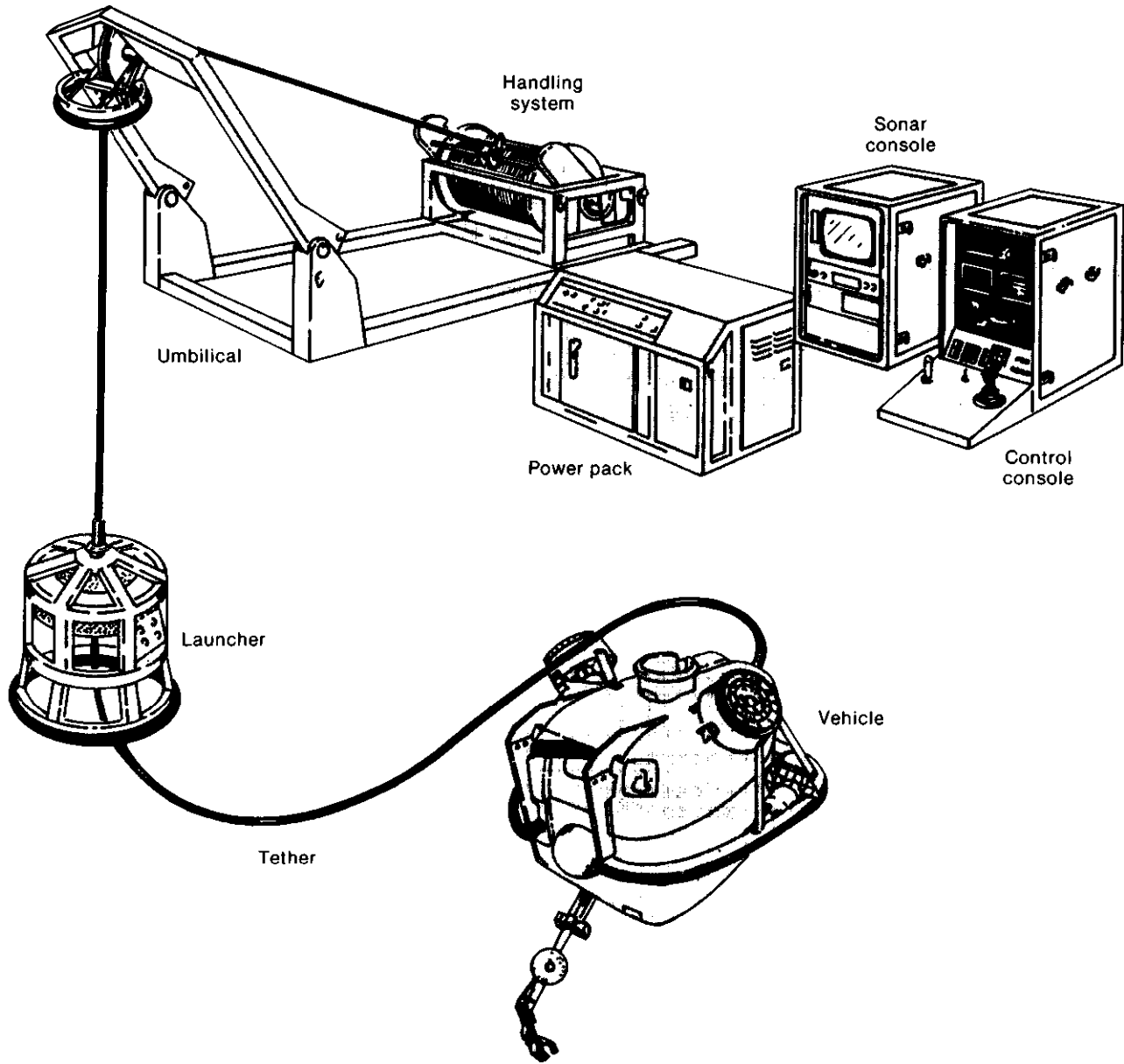

Vehicles of this type usually carry one or more closed-circuit television cameras, lights, grabbers, and instruments for monitoring and measuring.

SOURCE: Busby Associates, Inc.

cate. Comparisons of the relative advantages and disadvantages of manned submersibles and ROVs are difficult to make unless a particular task has been specified and the environment in which it has to operate is known. The first major advantage of a manned vehicle is that the observer has a direct,

three-dimensional view of the target to be investigated or worked on. Second, the manipulative capability of certain types of manned vehicles is superior to ROVs. Third, the absence of a drag-producing cable connecting the manned submersible to its support ship permits the submersible to oper-

ate within stronger currents and at greater depths than most ROVs can presently operate.

Nonetheless, manned submersibles have several drawbacks. Most industrial applications require working around and within a structure where the possibility of entanglement/entrapment is often present and, consequently, human safety is potentially in jeopardy. Manned vehicles that operate independently of a surface-connecting umbilical cord can operate for a duration of 6 to 8 hours before exhausting batteries. Even with more electrical power, there is a limit to how long human occupants can work effectively within the confines of a small diameter sphere—6 to 8 hours is about the limit of effectiveness. Relative to ROVs, a manned submersible operation will always be more complex, since there is the added factor of providing for the human crew inside.

The two major advantages of ROVs are that they will operate for longer durations than manned vehicles (limited only by the electrical producing capability of the support ship) and that there is a lower safety risk for humans. Towed ROVs, for example, can and do operate for days and even weeks before they need to be retrieved and serviced. The many varieties of ROVs (at least 99 different models produced by about 40 different manufacturers) permit greater latitude in selecting a support craft than do manned submersibles (which usually have dedicated support vessels). Many ROVs, because of their small size, can access areas that manned vehicles cannot. Because ROV data and television signals can be relayed continuously to the surface in real-time, the number of topside observers participating in a dive is limited only by the number of individuals or specialists that can crowd around one or several television monitors. Depending on the depth of deployment and the type of work conducted, an ROV may incur only a fraction of the cost of operating a manned submersible.

Probably the most debated aspect of manned v. unmanned vehicles is the quality of viewing the sub-sea target. There is no question that a television camera cannot convey the information that a human can see directly. Even with the high quality and resolution of present underwater color television cameras and the potential for three-dimensional television viewing, the image will probably

never equal human observation and the comprehension it provides. To the scientific observer, direct viewing is often mandatory. For the industrial user, this is not necessarily the case. Some segments of industry may be satisfied with what can be seen by television, and, while they would probably like to see more, they can see well enough with television to get the job done. The distinction between scientific and industrial needs is important because in large part, it allowed the wide-scale application of the ROV, which contributed to the slump in manned vehicle use.

costs

The cost of undersea vehicles varies as widely as their designs and capabilities. One of the few generalizations that can be made regarding costs is that they increase in direct proportion to the vehicle's maximum operating depth.

Manned submersibles can cost from as little as \$15,000 for a one-person vehicle capable of diving to 45 meters (150 feet) to as much as \$5 million for an *Alvin* replacement. A replacement for the Johnson-Sea-Link, which is capable of diving to over 900 meters (3,000 feet), would cost from \$1.5 million to \$2 million. These figures do not include the support ships necessary to transport and deploy the deeper diving vehicles. Such vessels, if bought used, would range from \$2 million to \$3 million; if bought new, they could cost from \$8 million to \$10 million.

ROVs also range widely in costs. There are tethered, free-swimming models currently available that cost from \$12,000 to \$15,000 per system, reach depths of 150 and more meters, and provide video only. At the other end are vehicles that reach depths in excess of 2,400 meters, are equipped with a wide array of tools and instrumentation, and cost from \$1.5 million to \$2 million per system. Intermediate depth (900 meters/3,000 feet) systems equipped with manipulators, sonars and sensors range from \$400,000 to \$500,000. Most of the towed vehicles presently available are deep diving (20,000 feet) systems requiring a dedicated support ship and extensive surface support equipment. Such systems start at about \$2 million and can, in the case of the towed hybrid systems, reach over \$5 million.

The foregoing prices are quoted for new vehicles only. However, in today's depressed offshore service market, there are numerous opportunities for obtaining used manned and remotely operated vehicle systems for a fraction of the prices quoted above. Likewise, support ships can be purchased at similar savings. This generalization does not apply to the towed or the hybrid systems, since they were built by their operators and are not commercial vehicles.

Capabilities

The environmental limits within which a vehicle can work are determined by such design features as operating depth, speed, diving duration, and payload. These factors are also an indication of a vehicle's potential to carry equipment. The actual working or exploration capabilities of a manned or unmanned vehicle are measured by the tools, instruments, and/or sensors that it can carry and deploy. These capabilities are, in large part, determined by the vehicle's carrying capacity (payload), electrical supply, and overall configuration. For example, *Deep Tow* represents one of the most sophisticated towed vehicles in operation. Its equipment suite includes virtually every data-gathering capability available for EEZ exploration that can be used with this type of vehicle. On the other hand, there are towed vehicles with the same depth capability and endurance as *Deep Tow* but which cannot begin to accommodate the vast array of instrumentation this vehicle carries, due to their design. Table 4-8 is a current worldwide listing of towed vehicles and the instrumentation they are designed to accommodate. Towing speed of these vehicles ranges from 2 to 6 knots.

Tethered, free-swimming ROVs offer another example of the wide range in exploration capabilities available in today's market. Vehicles with the most basic equipment in this category have at least a television camera and adequate lighting for the camera (although lighting may sometimes be optional). However, there is an extensive variety of additional equipment that can be carried. The ROV Solo, for example, is capable of providing real-time observations via its television camera, photographic documentation with its still camera, short-range object detection and location by its scanning sonar, and samples with its three-function

grabber (i. e., manipulator). The vehicle is also equipped for conducting bathymetric surveys. Assuming it is supported by an appropriate subsea navigation system, it can provide:

- a high-resolution topographic profile map on which the space between sounding lanes is swept and recorded by side-looking sonar,
- a sub-bottom profile of reflective horizons beneath the vehicle,
- a chart of magnetic anomalies along the tracks covered,
- television documentation of the entire track,
- selective stereographic photographs of objects or features of interest, and
- the capability to stop and sample at the surveyor's discretion.

With adequate equipment on the vehicle and support ship and the proper computer programs, the entire mapping program, once underway, can be performed automatically with little or no human involvement. At least a dozen more competitive models exist that can be similarly equipped.

In addition to ROVs of the *Deep Tow* and Solo class, several vehicles have been designed to conduct a single task rather than multiple tasks. One such vehicle is the University of Georgia's Continuous Seafloor Sediment Sampler, discussed earlier in the section on nuclear methods.

Untethered, manned vehicles are, for the most part, equipped with at least one television camera, still camera, side-looking sonar, and manipulator, and with pingers or transponders compatible with whatever positioning system is being used. The absence of an umbilical cable has an advantage that received little attention until the *Challenger* space shuttle tragedy in 1986. *Challenger's* debris was scattered under the Atlantic Ocean's Gulf Stream, which flows at maximum speed on the surface but decreases to less than 0.25 knot at or near the bottom. Once the manned submersibles used in the search descended below the swift flowing surface waters (upwards of 3 knots), they worked and maneuvered without concern for the current. The ROVs used, on the other hand, were all tethered, and, even though the vehicle itself might be operating within little or no discernible current, the umbilical had to contend with the current at all times. This caused considerable difficulty at times during the search operation.

Table 4-8.—Worldwide Towed Vehicles

Vehicle	Depth (ft.)	Instrumentation	Operator
ANGUS	20,000	Still camera w/strobe, echo sounder, temperature sensor	Woods Hole Oceanographic Institution, Woods Hole, MA, USA
<i>Brut IV</i>	900	TV camera w/light, still camera w/strobe, automatic altitude control	Biological Station, St. Andrews, New Brunswick, NS, Canada
CSA/STCS	1,000	TV w/light	Continental Shelf Associates, Jupiter, USA
CSA/UTTS	1,150	TV w/lights, still camera w/strobe, altimeter	Continental Shelf Associates, Jupiter, USA
<i>Deep Challenger</i>	20,000	TV w/lights, still camera w/strobe, side-looking sonar, sub-bottom profiler, depth/altitude sensor, C/T/D sensors	Japan Marine Science & Technology Center, Yokosuka, Japan
<i>Deep Tow</i>	20,000	Slow-scan TV w/ strobe illumination, echo sounder, side-looking sonar, scanning sonar, magnetometer, stereo camera system, C/T/D sensors, transponder	Marine Physical Laboratory, Scripps Institution of Oceanography, La Jolla, CA, USA
<i>Deep Tow Survey System</i>	20,000	TV w/ light, still camera w/ strobe, side-looking sonar, magnetometer sub-bottom profiler, current meter, altitude/depth sensor	Lockheed Ocean Laboratory, San Diego, CA, USA
DSS-125 (4 each)	20,000	TV w/ light, still camera w/ strobe, magnetic compass	Japanese and West German industrial firms.
Manta	2,132	TV w/ lights, still camera w/ strobe, side-looking sonar, C/T/D sensors	National Marine Fisheries Service, Pascagoula, MS, USA
<i>Nodule Collection Vehicle</i>	NA	Cutting and pumping devices to collect nodules for transport to surface	National Research Institution for Resources & Pollution, Japan
<i>Ocean Rover</i>	1,000	TV on pan/tilt w/ light, still camera w/ strobe, depth and speed sensor	Seamatrix Ltd., Aberdeen, Scotland
OFOS	20,000	Color TV and three still cameras w/ appropriate lighting	Preussag Meerestechnik, Hannover, West Germany
Raie II	20,000	Still cameras w/ strobe echo sounder, pressure/depth sensor, transponder	IFREMER, Brest, France
<i>Sea Bed 2</i>	6,500	Side-looking sonar (6km swath), sub-bottom profiler	Huntec, Ltd. Scarborough, Ontario, Canada
<i>Sea Kite</i>	1,000	TV, still camera, pipe, tracker, scanning sonar, side-looking sonar, sub-bottom profiler, magnetometer	Blue Deep Sari, Valmondois, France
Sound (b each)...	13,000	TV w/ light, still camera w/ strobe, side-looking sonar, magnetometer, seismic profiler	Institute of Oceanology, Moscow, USSR
STSS	20,000	TV w/ light, still camera w/ strobe, scanning sonar, side-looking sonar, altitude/depth sonar, transponder	Submarine Development Group One, U.S. Navy, San Diego, CA, USA
<i>Teleprobe</i>	20,000	TV w/ light, stereocameras w/ strobes, magnetometer, side-looking, altitude/depth sonar	U.S. Naval Oceanographic Office, Bay St. Louis, MS, USA
<i>Turn s</i>	20,000	TV w/ light, stereocameras w/ strobe, scanning sonar, side-looking sonar, magnetometer, manipulator	Royal British Navy

SOURCE: Busby Associates, Inc., Arlington, Virginia.

Very little work using manned or ROVs has been done solely for exploration purposes. In the industrial arena, the work has been in support of offshore oil and/or gas operations, including pipeline and cable route mapping and inspection, bottom site surveying, structural inspection and maintenance,

and a wide variety of other tasks. Scientific application of undersea vehicles has been almost always directed at studying a particular phenomenon or aspect of an ecosystem. In only a few instances have undersea vehicles been used to verify the data collected by surface-oriented techniques.

Hard mineral exploration, however, is a task well-suited for manned vehicles and tethered, free-swimming ROVs. A wide array of manipulator-held sampling equipment for these vehicles has been developed over the past two decades. This sampling capability ranges from simple scoops to gather unconsolidated sediment to drills for taking hard-rock cores. Present undersea vehicles cannot, however, collect soft sediment cores much beyond 3 feet in length or hard-rock cores more than a few inches in length,

The Continuous Seafloor Sediment Sampler is an example of a specially designed vehicle. Vehicles of this type might find extensive application in the EEZ by providing relatively rapid mineral assays of the bottom within areas of high interest. If supported with appropriate navigation equipment, a surficial mineral constituent chart could be developed fairly rapidly. Due to the vehicle's present design, such a map could only be made over bottoms composed of unconsolidated, fine-grained sediments.

A recent example of a vehicle application was the search for and subsequent examination of the RMS *Titanic*, which sank in the Atlantic in 1912. The vessel was thought to be somewhere within a 120-square-nautical-mile area. A visual search with an undersea vehicle could literally take years to complete at the 4,000-meter (13,000-foot) depths in which she lay. Instead, the area was searched using a side-looking sonar which detected a target of likely proportions after about 40 days of looking. To verify that the target was the *Titanic*, the towed vehicle *ANGUS* was dispatched with its television and still cameras. The next step, to closely examine the vessel, was done with the manned vehicle *Alvin* and the tethered, free-swimming ROV *Jason Junior (JJ)*. *Alvin* provided the means to 'home on' and board the vessel, while *JJ* provided the means to explore the close confines of the vessel's interior.

The search for the space shuttle *Challenger* debris is another example of the division of labor between undersea vehicles and over-the-side techniques. Since the debris was scattered over many square miles and intermixed with debris from other sources, it would have taken months, perhaps years, to search the area with undersea vehicles. Instead, as with the *Titanic*, side-looking sonar was used

to sweep the area of interest and likely targets were plotted to be later identified by manned and unmanned vehicles. The same vehicles were subsequently used to help in the retrieval of debris. Once again, the large area was searched with the more rapid over-the-side techniques while precision work was accomplished with the slower moving undersea vehicles.

These two examples suggest that the main role of undersea vehicles in the EEZ is and will be to provide the fine details of the bottom. A typical exploration scenario might begin with bottom coverage with a wide-swath side-looking sonar, like GLORIA, progress to one of the midrange side-looking sonars or a Sea Beam-type system, and end with deployment of a towed vehicle system or a tethered, free-swimming ROV or manned submersible to collect detailed information.

Needed Technical Developments

Thanks to technological advances in offshore oil exploration, the tools, vehicles, and support systems available to the EEZ minerals explorer have increased dramatically in numbers and types since the 1960s. It would appear that adequate technology now exists to explore selected areas within the EEZ using undersea vehicles. But, as with offshore oil, some of these assets will probably prove to be inadequate when they are used for hard mineral exploration instead of the tasks for which they were designed. Identification of these shortcomings is probably best accomplished by on-the-job evaluation.

More than likely, whatever technological improvements are made will not be so much to the vehicles themselves but to the tools and instrumentation aboard the vehicles that collect the data. Hence, it is important to identify precisely the data-collecting requirements for hard mineral exploration and mining. Potential discovery of new underwater features, processes, and conditions must also be anticipated. For example, prior to 1981, nothing was known of the existence of deepwater vents or of the existence of the animals that inhabit these areas. Once the vents and their associated fauna were discovered, tools and techniques for their investigation were developed as necessary.

Certain aspects of undersea vehicles and their equipment are perennial candidates for improve-

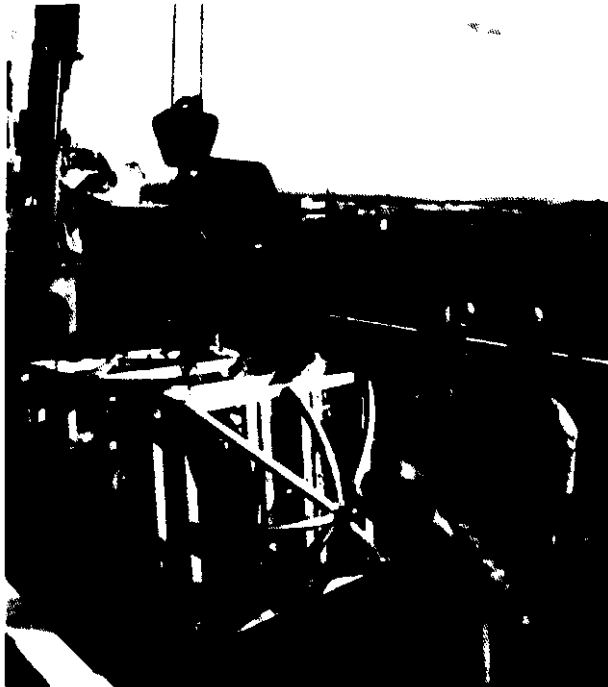

Photo credit: U.S. Geological Survey

Underwater camera system, ready for deployment

ment. These include, but are not limited to, broader bandwidths for television signals, greater manipulative dexterity and sensory perception, and more precise station-keeping and control of the vehicle itself. The advent of the microprocessor has introduced other candidates: artificial intelligence, pattern recognition, teach/learn programs, greater memory, all of which can serve to improve the capability of the vehicles and their accompanying sensors and tools. There is no question that these aspects of vehicle technology are worthy of consideration and that they will undoubtedly improve our underwater exploration capability. But before additional development or improvement of undersea vehicle technology for EEZ hard minerals exploration begins, it may be more important to assess fully the applicability of the currently available technology.

Optical Imaging

Optical images produced by underwater cameras and video systems are complementary to the images and bathymetry provided by side-looking sonars and bathymetry systems. Once interesting features

have been identified using long-range reconnaissance techniques, still cameras and video systems can be used for closeup views. Such systems can be used to resolve seafloor features on the order of 10 centimeter to 1 meter. The swath width of imaging systems depends on such factors as the number of cameras used, the water characteristics, and the height of the imaging system above the seafloor. Swaths as wide as 200 meters are currently mappable.

ANGUS (Acoustically Navigated Underwater Survey) is typical of many deep-sea photographic systems. Basically, *ANGUS* consists of three 35-millimeter cameras and strobe lights mounted on a rugged sled. The system is towed approximately 10 meters off the bottom in water depths up to 6,000 meters (19,700 feet), and is capable of taking 3,000 frames per sortie. It has been used in conjunction with dives of the submersible *Alvin*.

A newer system, currently under development at the Deep Submergence Laboratory (DSL) at Woods Hole Oceanographic Institution, is *Argo*. On her maiden voyage in September 1985 *Argo* assisted in locating the *Titanic*. Like *ANGUS*, *Argo* is capable of operating in water depths of 6,000 meters. *Argo*, however, is equipped with a wide-area television imaging system integrated with side-looking sonar.⁷⁶ It currently uses three low-light-level, silicon-intensified target cameras (one forward-looking, one down-looking, and one down-looking telephoto), extending the width of the imaged swath to 56 meters (184 feet) when towed at an altitude of 35 meters.

Argo is being designed to accommodate a second ROVs, to be known as *Jason*. *Jason* will be a tethered robot capable of being lowered from *Argo* to the seafloor for detailed camera (and sampling) work (figure 4-13). Its designers plan to equip *Jason* with stereo color television "eyes."⁷⁷ One current limitation is the lack of availability of an adequate transmission cable for the color television pictures. Color television transmissions exceed 6 million bits per second, and large bandwidth cables capable of carrying this amount of information have not yet been developed for marine use. Fiber-optic cables are now being designed for this

⁷⁶S.E. Harris and K. Albers, "Argo: Capabilities for Deep Ocean Exploration, *Oceanus*, vol. 28, No. 4, 1985/86, p. 100.

⁷⁷R. D. Ballard, "Argo-Jason, *Oceans*, March 1983, p. 19.

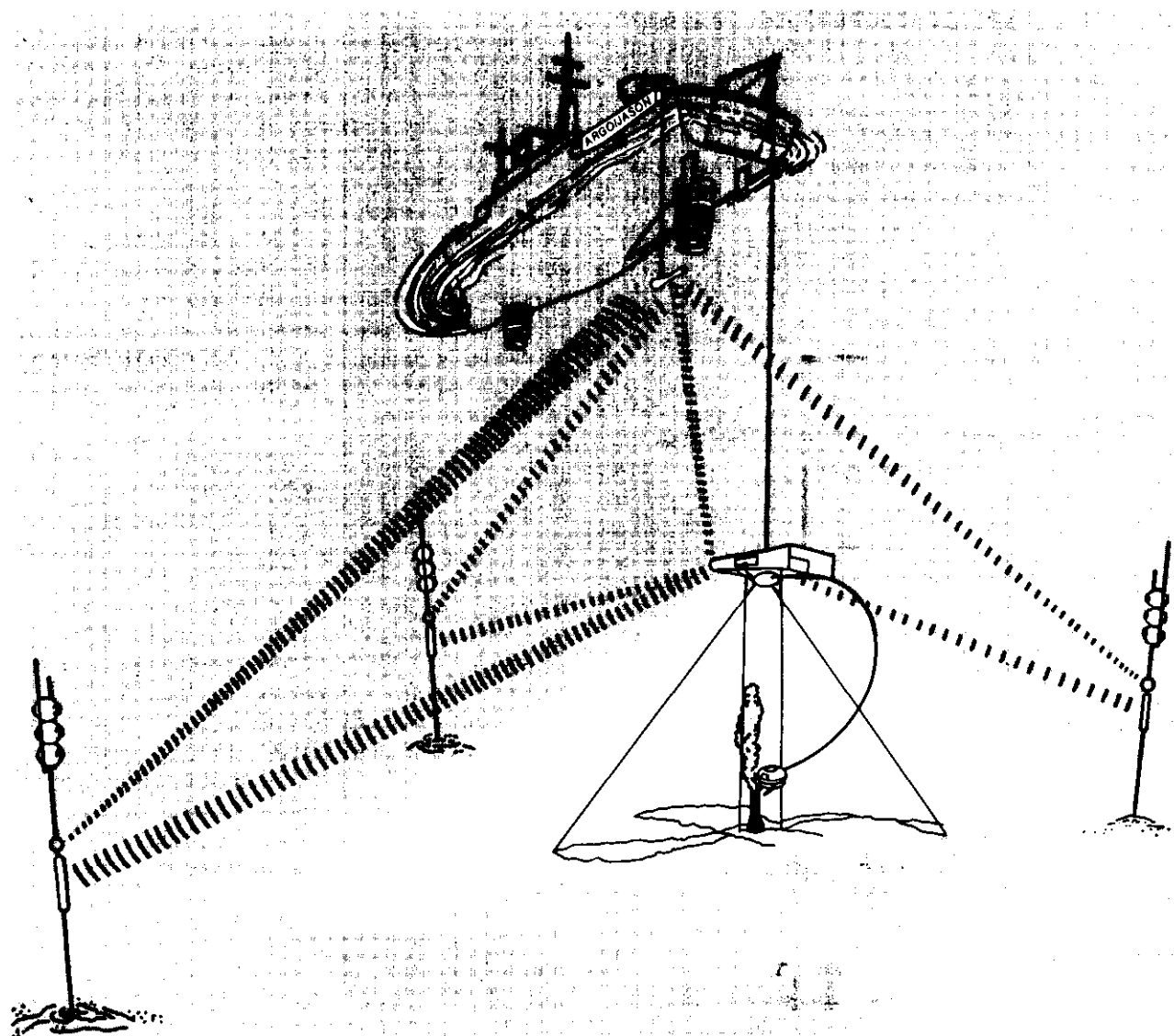
Figure 4-13.—Schematic of the *Argo-Jason* Deep-Sea Photographic System

The *Argo-Jason* system is currently under development at Woods Hole's Deep Submergence Laboratory. *Argo* has already assisted in locating the *Titanic*. *Jason* is being designed to be launched from *Argo* and will handle detailed camera work.

SOURCE: Woods Hole Oceanographic Institution.

and related marine data transmission needs. However, before fiber-optic cables can be employed, problems of handling tensional stress and repeated flexing of the cable must be overcome. Personnel at DSL believe that when the *Argo-Jason* system is fully developed, the need for manned submersibles will be much reduced.

The current subject-to-lens range limit for optical imaging is 30 to 50 meters in clear water. Several improvements are expected in the future that may enable subjects to be imaged as far as 200 meters from the lens under optimal viewing conditions. For instance, work is underway to increase the sensitivity of film to low light levels. A 200,000

ASA equivalent speed film was used to take pictures of the *Titanic* under more than 2 miles of water. Higher film speed ratings, perhaps as high as 2 million ASA equivalent, will enable pictures to be taken with even less light. Improved lighting will also help. The optimal separation between camera and light in the ocean is about 40 meters, which suggests that towed light sources could provide an advantage. Use of polarization filters can also help increase viewing potential. Gated light sources, which emit short pulses of light, will be more expensive to develop. Development of a technique to open the camera shutter at the precise time the gated light illuminates the subject will help reduce scattering of the reflected light. 78

Direct Sampling by Coring, Drilling, and Dredging

Once a prospective site is located using geophysical and/or other reconnaissance methods, direct sampling by coring, drilling, or dredging (as appropriate) is required to obtain detailed geological information. Direct sampling provides "ground truth" correlation with indirect exploration methods of the presence (and concentration) or absence of a mineral deposit. The specific composition of a deposit cannot be determined without taking samples and subjecting them to geochemical analyses. Representative sampling provides potential miners with information about the grade of deposit, which is necessary to decide whether or not to proceed with developing a mine site.

Placer Deposits

The state-of-the-art of sampling marine placers and other unconsolidated marine sediments is more advanced than that of sampling marine hard-rock mineral deposits such as cobalt crusts and massive sulfides. There are various methods for sampling unconsolidated sediments in shallow water, whereas technology for sampling crusts and sulfides in deep water is only now beginning to be developed. Two significant differences exist between sampling placer deposits and marine hard-rock deposits. One is the greater depth of water in which crusts and sulfides

occur. The other is the relative ease of penetrating placers.

Grab samplers obtain samples in the upper few centimeters of surficial sediments. For obtaining a sample over a thicker section of sediments and preserving the sequence of sedimentary layers, vibracore, gravity, piston, and other coring devices are used. These corers are used to retrieve relatively undisturbed samples that may indicate the concentration of minerals by layer and the thickness of the deposit. On the other hand, to determine the average grade of ore at a particular site and for use in processing studies, large bulk samples obtained by dredging (including any waste material or overburden), rather than undisturbed cores, may be sufficient.

The characteristics of a sampling device appropriate for a scientific sampling program are not necessarily appropriate for proving a mine site. In order to establish tonnage and grade to prove a mine site, thousands of samples may be required. It is essential that the sampling device provide consistently representative samples at a reasonable cost. The ability to carry out commercial-scale sampling, required to define an ore body, in water deeper than about 60 feet is still very limited. Scientific sampling can be done in deeper water, but as table 4-9 indicates, sampling costs rapidly escalate with water depth. The costs of sampling in deeper water probably will have to be reduced significantly before commercial development in these areas can take place.

Only a few areas within the U.S. Exclusive Economic Zone have been systematically sampled in three dimensions. Much of the data collected to date have been from surface samples and hence are not reliable for use in quantitative assessments. 79 Adequate knowledge of the mineral resource potential of the EEZ will require extensive three-dimensional sampling in the most promising areas.

Several factors, as suggested above, are important in evaluating the performance of a placer sampling system⁸⁰ (in general, these factors are equally

⁷⁸R. Ballard, Dee, Submergence Laboratory, Woods Hole Oceanographic Institution, OTA Workshop on Technologies for Surveying and Exploring the Exclusive Economic Zone, June 10, 1986.

⁷⁹See, for example, Clifton and Luepke, "Heavy Mineral Placer Deposits.

⁸⁰B. Dimock, "An Assessment of Alluvial Sampling Systems for Offshore Placer Operations, Report, Ocean Mining Division, Resource Evaluation Branch, Energy, Mines, and Resources Canada, January 1986.

Table 4-9.—Vibracore Sampling Costs^a

	Shallow water	Deep water
Water depth	30-60 feet	200 to 300 feet
Type of coring equipment	Vibracorer	Vibracorer (equipped for deep water operation)
Number of cores in program	50	50
Depth of penetration	20 feet	20 feet
Type of vessel	100- to 150-foot open deck work boat, twin screw equipped with A-frame and double point mooring gear	150- to 200-foot open deck work boat, twin screw, equipped with A-frame and double point mooring gear
Mobilization/demobilization cost	\$25,000	\$50,000
Vessel cost	\$50,000 (10 days at \$5,000 per day; assumes 6 cores per day; 30% downtime for weather)	\$160,000 (20 days at \$8,000 per day; assumes 3 cores per day; 30% downtime for weather)
Coring equipment and operating crew	\$30,000 (10 days at \$3,000 per day)	\$100,000 (20 days at \$5,000 per day)
Contingency funds	\$25,000	\$25,000
Total cost	\$130,000	\$335,000
Cost per core	\$2.600	\$6,700

^aCosts do not include core analysis and program management.

SOURCE: Office of Technology Assessment, 1987.

applicable to technologies for sampling massive sulfides and cobalt crusts). The representativeness of the sample is very important. A sample is representative if what it contains can be repeatedly obtained at the same site. In this regard, the size of the sample is important. For example, for minerals that occur in low concentrations (e. g., precious metals), a representative sample must be relatively large. A representative sample for concentrated heavy minerals may be much smaller. The depth of sediment that a sampling tool is capable of penetrating also affects the representativeness of the sample.

Undisturbed samples are particularly important for studying the engineering properties and depositional history of a deposit. They are less important for determining the constituents of a deposit.

Other relevant factors affecting sampling performance include: the time required to obtain a sample; the ease of deploying, operating, and retrieving the sampling device in rough seas; the support vessel requirements; and the core storage capability. Sampling tools that can sample quickly, can continue to operate under adverse conditions, and can be deployed from small ships are preferred when the cost of sampling is a significant factor. More often, the solution is a compromise among these factors.

Grab and Drag Sampling.—Grab sampling is a simple and relatively inexpensive way of obtaining a sample of the top few inches of the seafloor.

With its mechanical jaws, a grab sampler can take a bite of surficial sediment. However, a sample of surficial sediment is not likely to be representative of the deposit as a whole. Buried minerals may be different from surface minerals, or, even if the same, their abundance may be different. Moreover, the sediments retrieved in a grab sample are disturbed. Some of the finer particles may even escape as the sample is being raised, particularly if stones or debris prohibit the jaws from closing properly.

Notwithstanding their shortcomings, grab samples have helped geologists gain some knowledge of possible heavy mineral concentrations along the Eastern U.S. seaboard. However, grab samples provide limited information and are not appropriate for detailed, quantitative sampling of a mineral occurrence. Drag sampling is similar to grab sampling in that it is designed to retrieve only samples from the surface. An additional limitation of this type of sampling is that sample material is retrieved all along the drag track and, therefore, sampling is not representative of a specific site.

Coring and Drilling Devices.—For more quantitative sampling, numerous types of coring or drilling technologies have been developed. Impact corers use gravity or some type of explosive mechanism to drive a core barrel a short distance into sediment. Percussion drilling devices penetrate sediment by repeated pile driving action. Vibratory



Photo credits: US. Bureau of Mines, U.S. Geological Survey

Chain bag dredge

Dredges Used for Sampling the Seafloor

corers use acoustical or mechanical vibrations to penetrate material.⁸¹

An example of an impact coring device is the box core. An advantage of this type of sampling system is that it retrieves relatively undisturbed cores. A disadvantage is that a box corer is capable of sampling only the top few feet of an unconsolidated deposit. It is rarely used in sand because penetration requires additional vibratory or percussive action.

⁸¹M. S. Barre and W. Lee, *Marine Mining of the Continental Shelf: Legal, Technical and Environmental Considerations* (Cambridge, MA: Ballinger Publishing Co., 1978), p. 70.

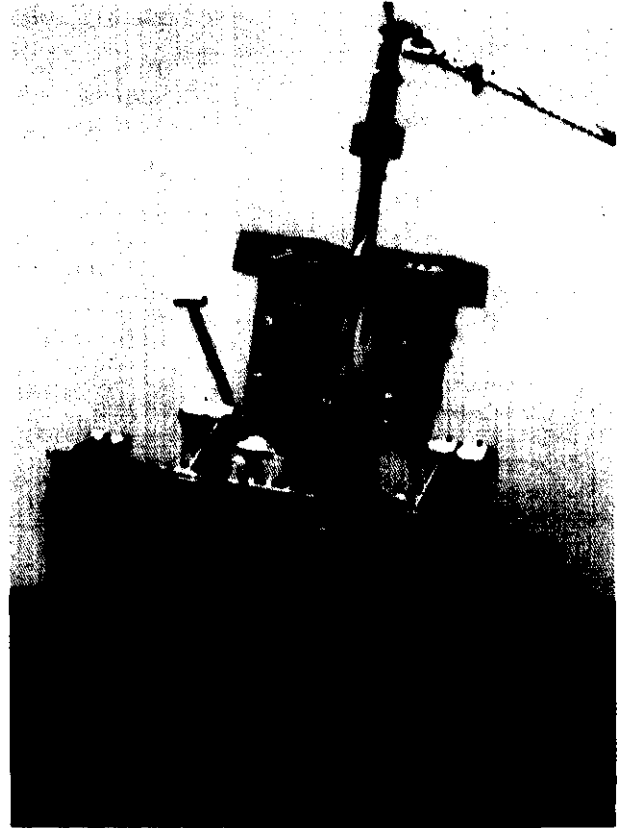

Grab dredge

Well-known percussion drilling devices include the Becker Hammer Drill and the Amdril series of drills. The Becker drill penetrates sediment using a diesel-powered hammer that strikes a drill pipe 91 times per minute. It also uses reverse circulation, meaning that air and/or water is pumped down the annulus between the inner and outer drill pipes, continuously flushing sample cuttings to the surface through the inner pipe.⁸² Among the advantages of the Becker drill are: its capability to recover all types of deposits, including gravel, sand, boulders, and clay; its ability to drill in a combined depth of water and sediments up to about 150 feet; and its capacity to recover representative samples. However, open water use of the Becker drill is slow and relatively expensive.

The Becker drill is rated by some⁸³ as one the best existing systems for offshore quantitative sam-

⁸²Dimock, "An Assessment of Alluvial Sampling Systems, p. 10.

⁸³1 *ibid.*, p. 55.



Photo credit: Bonnie McGregor, U.S. Geological Survey

The box core retrieves relatively undisturbed cores but only of the first few feet of sediment.

pling of marine placers. It has been widely and reliably used in offshore programs around the world. Other systems may work well but the Becker drill has gained the confidence of investment bankers, who must know the extent and tenor of a deposit with a high degree of accuracy before investing money in development. For developing commercial deposits, it is particularly important that the method used be one with a proven record.

The Amdril, available in several different sizes, is another type of percussion drilling device. Unlike the Becker Hammer Drill, Amdrils are submersible and virtually independent of the support ship's movements. As a result, this drill can operate in much deeper water than the Becker drill. Rather than using the reverse circulation method, an independent pipe supplies air to the casing to raise the drill cuttings. Although the Amdril can-

not sample boulders or bedrock, it is capable of sampling gravel (unlike vibratory corers) using an airlift system. One type of Amdril has successfully sampled marine sands and gravels off Great Britain.⁸⁴

A somewhat similar system, the Vibralift, developed by the Mississippi Mineral Resources Institute, has proved successful in sampling a variety of mineral deposits, including heavy minerals in dense and semi-hard material. The Vibralift is basically a counterflush system. It utilizes a dual wall drill pipe driven into the sediment by means of a pneumatic vibrator. Water under pressure is introduced to the annular space of the dual pipe via a hose from a shipboard pump and is jetted into the inner pipe just above the cutting bit. In this way, the core rising in the inner pipe during the sample drive is broken up by the water jets and transported up the pipe through a connecting hose and finally to a shipboard sample processor. Additional lift is obtained by routing exhaust air from the vibrator into the inner pipe. Samples are collected in a dewatering box to minimize the loss of fine material.⁸⁵

Several types of vibratory corers have been developed over the years. Designs vary by length of core obtained (6 to 12 meters), by core diameter (5 to 15 centimeters), by water depth limits of operation (25 to 1,000 meters), by method of penetration (electric, hydraulic, and pneumatic), by portability, etc. Vibratory corers have been widely used for scientific and reconnaissance sampling. This method is probably the best low-cost method for coring sand and gravel deposits. Relatively undisturbed and representative cores can be retrieved in unconsolidated sediments such as most sands, clay, and gravel. However, the effectiveness of vibratory corers decreases in dense, fine, relatively consolidated sands and in stiff clays. Some progress has been reported in sampling dense, fine-grained, heavy mineral placers with a jet bit that does not disturb the core.⁸⁶ Vibratory corers will not penetrate boulders or shale. This type of sampling device is less expensive and more portable than the Becker Hammer Drill and is, therefore, probably

⁸⁴ Ibid., p. 31.

⁸⁵ R. Woolsey demonstrated at Underwater Mining Institute Conference, Biloxi, MS, November 1986.

⁸⁶ Ibid.

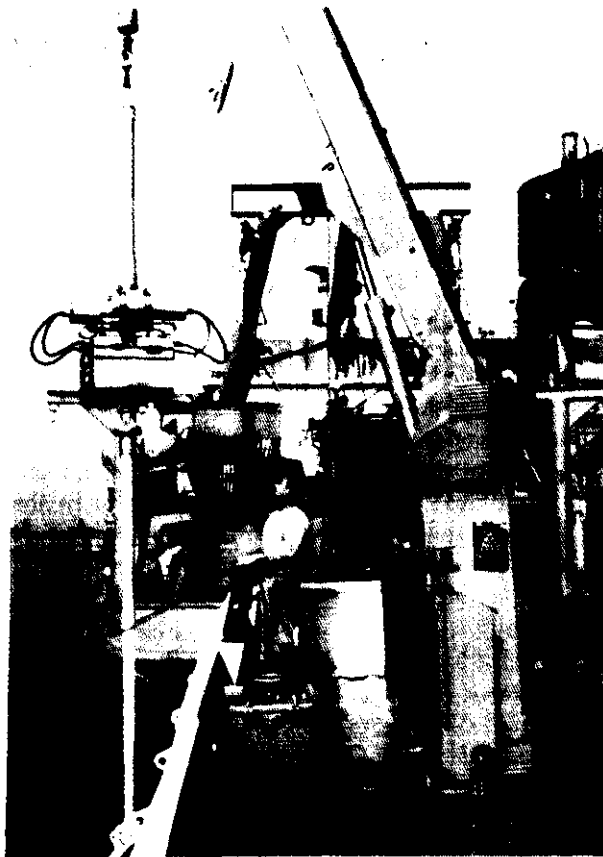

Photo source: P. Johnson, Office of Technology Assessment

Vibracore ready for deployment from side of ship. Vibracores can retrieve relatively undisturbed samples in many types of unconsolidated sediment.

more suitable for reconnaissance work than the Becker drill; however, given limitations in the type of deposit that can be sampled, vibratory corers would be less appropriate for proving certain mine sites.

Vibracore systems, properly designed and operated, have successfully evaluated thin (i.e., less than 12 meters), surficial, unconsolidated deposits of fine-to-coarse-grain material, such as sand and gravel, shell, heavy minerals, and phosphorite. Vibratory corers are inadequate for the more disseminated precious mineral placers such as gold, platinum, and diamonds, due to system limitations in sampling host gravels typically containing cobbles and boulders. Vibratory corers are also useless for any deposit where the thickness of overburden and/or zones of interest exceed the penetration limits of the system.

The costs of offshore sampling vary widely, depending on such factors as water depth, mobilization costs, weather, navigation requirements, and vessel size and availability. One of the most important factors in terms of unit costs per core is the scope of the program. Costs per hole for a small-scale program will be higher than costs per hole for a large-scale program. Table 4-9 shows typical costs of offshore vibracore programs in shallow and deep water. Costs per core are seen to vary between about \$2,500 and \$7,000.

An alternative or supplementary strategy to taking the large numbers of samples that would be needed to prove a mine site is to employ a small, easily transportable dredge in a pilot mining project. Each situation is unique, but for some cases the dredge may be less expensive and may be better at reducing uncertainty than coring or drilling. Such a program was recently completed with a pilot airlift dredge off the coast of west Africa. Four tons of phosphorite concentrate were recovered for an economic evaluation.⁸⁷ Dredging would cause significantly more environmental disruption and may, unlike other sampling methods, require an environmental impact statement.

Crusts

Cobalt-rich ferromanganese crusts were discovered during the 1872-76 expedition of the HMS *Challenger*, but detailed studies have only recently begun. In general, existing coring and other devices developed to sample shallow-water placers are not appropriate for sampling crusts in deep water; therefore, new sampling technologies must be developed. An important consideration in developing new technology is that crusts and underlying substrate are usually consolidated and hard and therefore not as easily penetrated by either dredges or coring devices. Moreover, crusts are found at much greater depths than most unconsolidated deposits. The most desirable crusts are believed to occur between 800 and 2,500 meters water depth; thus, sampling equipment must at least be able to operate as deep as 2,500 meters. Crusts known to date rarely exceed 12 centimeters (5 inches) in thickness; therefore, there is no requirement for long samples.

⁸⁷A. Woolsey and D. Barger, "Exploration for Phosphorite in the Offshore Area of the Congo," *Marine Mining*, vol. 5, No. 3, 1986, pp. 217-237.

A few small samples of crust have been retrieved using standard deep-sea dredges. As these dredges are pulled along the bottom, they are able to dislodge chunks of the outcrop or gather already dislodged material; however, techniques and technology for precise, controlled sampling have yet to be developed. USGS has identified several needs in quantitative crust sampling and, through its Small Business Innovative Research program, has begun several feasibility studies to develop sampling tools.

As an aid in selecting sampling sites and in quantifying the volume of crust in a given area, a device that can measure crust thickness is an important need. Deepsea Ventures, Inc., has completed a conceptual study for such a device for USGS.⁸⁹ The goal is to develop a tool to measure crust thickness continuously and in real-time. Conceptually, a very-high-frequency acoustic-reflection profiler able to detect the crust surface and the interface between crust and host rock would be mounted aboard a sled and, with a video camera, towed 20 to 25 centimeters off the seafloor. A continuous signal would be sent to the surface ship via the tow cable. An important design consideration is the very rough terrain in which some cobalt crusts are found. Current design criteria call for the device to operate over relatively smooth areas with less than a 20° slope. Although it will not be able to operate on slopes steeper than 200, it is assumed that, at least initially, any crust mining that does occur will be done in relatively flat areas.

For quantitative sampling, two types of coring devices have been proposed and currently are being designed. Deepsea Ventures has developed concepts for a special sampling tool for taking an undisturbed sample suitable for studying the engineering properties of crust and underlying rock.⁹⁰ This corer would be capable of cutting a disc-shaped core 56 centimeters (22 inches) in diameter by 23 centimeters (9 inches) thick. The corer and a video camera would be mounted on a tripod anchored to the

sea bottom while the core is being cut. This type of corer would not be useful for detailed mapping of a deposit because the tripod must be lowered, positioned, and raised for each core cut, a process that would take more than 2 hours in 1,500 meters of water.

A second coring device more appropriate for reconnaissance sampling (and perhaps also for proving a mine site) has been designed and built by Analytical Services, Inc. (figure 4-14).⁹¹ The device is a percussion coring sampler that is designed

⁹¹J. Toth, Analytical Services, Inc., OTA Workshop on Site-Specific Technologies for "Exploring the Exclusive Economic Zone, Washington, DC, July 16, 1986.

Figure 4-14.—Prototype Crust Sampler

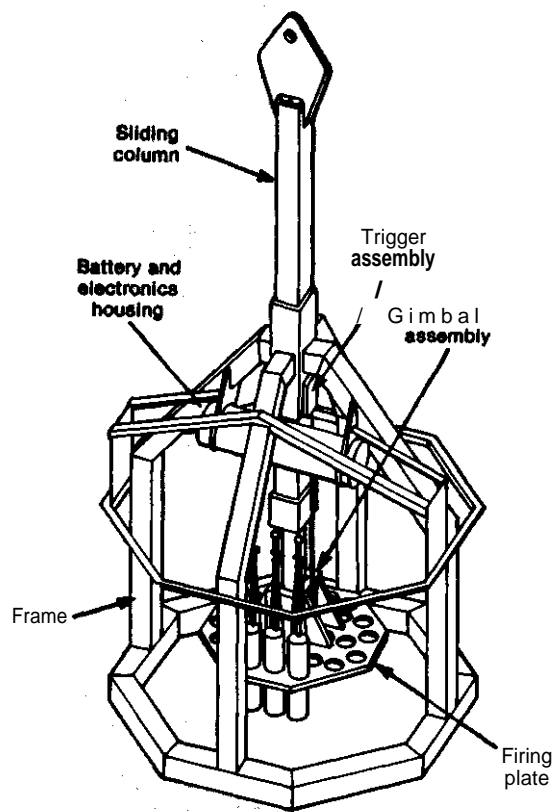

Coring devices such as this, designed to be quick and inexpensive, will be needed for quantitative sampling of crusts

SOURCE: Analytical Services, Inc., Cardiff, CA

⁸⁹D. S. Cronan, H. Kunzendorf, et al., "Report of the Working Group on Manganese Nodules and Crusts, *Marine Minerals: Advances in Research and Resource Assessment*, P. G. Teleki, et al. (eds.) (Dordrecht, Holland: 11, Reidel Publishing Co., 1987), NATO ASI Series, p. 24.

⁹⁰W. Siapno, Consultant, OTA Workshop on Site-Specific Technologies for Exploring the Exclusive Economic Zone, Washington, DC, July 16, 1986.

⁹¹Ibid.

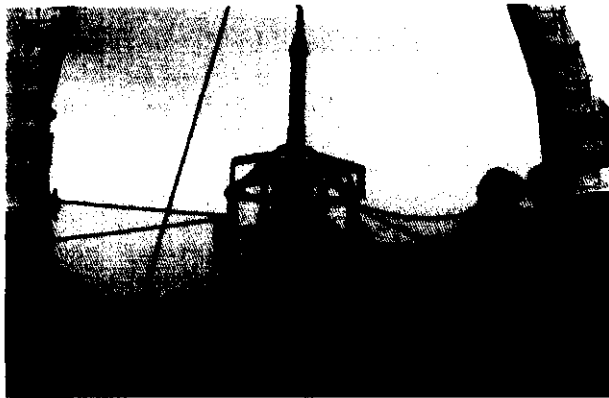

Photo credit: Analytical Services, Inc., Cardiff, CA

Prototype crust sampler about to be deployed from stern of ship.

to collect as many as 30 short cores during each deployment. The speed at which samples can be taken and the cost per sample are important design features—especially for corers that are used in proving a mine site—and this coring operation is designed to be both relatively quick and inexpensive. Sampling is initiated by a bottom-sensing trigger that starts a firing sequence. To fire the “gun,” an electric spark ignites the powder. As many as four samples may be taken at any one site, after which the system can be lifted from the seabed, moved to another spot, and lowered again. Cores are expected to be 10 to 12 centimeters long (long enough to sample crust and some substrate in most cases) and 2 centimeters (1 inch) in diameter. The system is designed to operate in water depths of 5000 meters. Eventually, a video system, scanning sonar, and thruster will be incorporated into the system, enabling the sampler to be steered. A second-generation prototype sampler has been built and was tested in 1987.

Large, bulk samples are required for processing and tonnage/grade studies. To meet these needs, the Bureau of Mines is developing a dredge capable of cutting into crust that maybe similar in principle to a commercial mining dredge of the future.⁹² Current dredges are not designed to cut into crust and substrate. The experimental dredge would theoretically collect 500 pounds of in situ material in each pass. Problems were encountered in initial

⁹²R. Willard, Bureau of Mines, OTA Workshop on Site-Specific Technologies for Exploring the Exclusive Economic Zone, Washington, DC, July 16, 1986.

testing of the dredge in rough terrain, but the dredge may be redesigned to better cope with rough seafloor features. The continuous bucket line dredge, used in sampling manganese nodules, is also proposed to be adapted for bulk sampling of crusts.

Polymetallic Sulfides

Massive sulfides have a third dimension that must be considered in sampling. At the moment, very little is known about the vertical extent of sulfide deposits, as drilling them has not been very successful. The problem lies in the absence of suitable drills.⁹³ Without a sediment overburden of 100 meters (328 feet) or so it is difficult to confine the drill bit at the start of drilling. The state-of-the-art of massive sulfide sampling is demonstrated by the fact that one of the largest samples collected to date was obtained by ramming a research submersible into a sulfide chimney, knocking the chimney over, and picking up the pieces with the submersible's manipulator arm.⁹⁴ Clearly, current bulk and core sampling methods leave something to be desired,

Recent advances have been made in bare-rock drilling. For example, one of the main purposes of Leg 106 of the Ocean Drilling Program (ODP) in December 1985 was to test and evaluate new bare-rock drilling techniques. Drilling from the ODP's 143 meter (470 foot) drill ship *JOIDES Resolution* took place in the Mid-Atlantic Ridge Rift Valley some 2,200 kilometers (1,200 nautical miles) south-east of Bermuda. The scientists and engineers of Leg 106 were partly successful in drilling several holes using such innovative techniques as a hard-rock guide base to confine the drill bit during initial ‘spud-in, a low-light television camera for imaging the seafloor and for monitoring drilling operations, and new downhole drilling and coring motors. The first hole took 25 days to penetrate 33.3 meters (110 feet) of rock below the seafloor, while recovering about 23 percent of the core material.⁹⁵

⁹³J. M. Edmond, F. P. Agterberg, et al., “Report of the Working Group on Marine Sulfides,” *Marine Minerals: Advances in Research and Resource Assessment*, P. G. Teleki, et al. (eds.) (Dordrecht, Holland: D. Reidel Publishing Co., 1987), NATO ASI Series, p. 36.

⁹⁴P. Hale, Offshore Minerals Section, Energy, Mines, and Resources Canada, OTA Workshop on Site-Specific Technologies for Exploring the Exclusive Economic Zone, Washington, DC, July 16, 1986.

⁹⁵R. S. Detrick, “Mid-Atlantic Bare-Rock Drilling and Hydrothermal Vents, *Nature*, vol. 321, May 1986, pp. 14-15.

Although improvements in drilling rates and core recovery are needed, the techniques demonstrated during Leg 106 open up new possibilities for drilling into massive sulfides.

In 1989, the *JOIDES Resolution* is tentatively scheduled to visit the Juan de Fuca Ridge, thus providing an opportunity to obtain a few cores from massive sulfide deposits. However, the *JOIDES Resolution* is a large, specially designed drill ship. Its size is governed, in part, by requirements for handling and storing drilling pipe. Because operating the *JOIDES Resolution* is expensive, it is not economically advantageous for inexpensive exploration sampling of massive sulfides in extensive areas.

An alternative and relatively less expensive approach to using a large and expensive drill ship for hard-rock sampling is to use a remotely operated submersible drill which is lowered by cable from a surface vessel to the seafloor.⁹⁸ In addition to lower cost, the advantages to using this type of drill are the isolation of the coring operation from sea-state-induced ship motions and reduced station-keeping requirements. Maintaining contact with a remotely operated drill while it is drilling remains difficult; if the umbilical is jerked during the drilling operation, the drill can easily jam. Several remotely operated drills have been conceived and/or built, as described below.

The drill developed by the Bedford Institution of Oceanography in Canada has probably had the most experience coring sulfides, although the performance of the drill to date has not met its design specifications. The Bedford drill is electrically powered from the surface and is designed to operate in over 3,500 meters of water. The drill can be deployed in winds of 25 to 30 knots and in currents up to 3 knots. It is designed to cut a core 6 meters long (extendable another 2.5 meters) with a diameter of 2.5 centimeters. A commercial version of this drill, made by NORDCO of St. John's, Newfoundland, is now available and has been sold to Australia, India, and Norway.⁹⁷

⁹⁶R. Petters and M. Williamson, "Design for a Deep-Ocean Rock Core Drill," *Marine Mining*, vol. 5, No. 3, 1986, p. 322.

⁹⁷P. J. C. Ryall, "Remote Drilling Technology," *Journal of Marine Mining*, in press, 1986.

Nine cores drilled through basalt were obtained with the Bedford drill in 1983 on the Juan de Fuca Ridge, but the total core length retrieved was only 0.7 meter.⁹⁸ Obtaining long cores has been difficult. Drillers have found that competent, unfractured rocks, such as metamorphic or intrusive types, yielded the longest cores, while young, glassy, highly fractured basalts were difficult to sample.⁹⁹ The massive sulfides themselves are easier to drill than fractured basalts.

Since 1983, the performance of the Bedford drill has improved. Recently, two cores, each about 1 meter long, were retrieved in gabbro. Drilling took place at the Kane Fracture Zone. Several foot-long cores containing sulfides also were taken from the Endeavor Segment of the Juan de Fuca Ridge. Mechanically, the drill has not been changed much, but electronics and control systems are better. The experience gained thus far suggests that it is essential to do preliminary reconnaissance work before emplacing the drill. During emplacement, a video camera attached to the drill frame also has proved helpful, as it lets drillers locate a stable position for the drill.

Several other remotely controlled drills have been designed and/or built. In the early 1970s, Woods Hole Oceanographic Institution built a rock drill designed to recover a 1 meter long, 2 centimeter diameter rock core from water depths as much as 4,000 meters. The drill was originally designed to be deployed from the research submersible *Alvin* but was later reconfigured to be deployed from a surface ship. It has not been used extensively.¹⁰⁰ A Japanese firm, Koken Boring & Machine Co., has built a remote battery-powered drill and used it successfully in 500 meters of water. NORDCO has recently developed a sampling system, that, depending on its configuration, can be used to sample either sediment or rock. This system was used in October 1985 to recover eight cores in 800 meters of water off Baffin Island.¹⁰¹ Finally, design of a

⁹⁸Hale Offshore Miner & Section, Energy, Mines, and Resources Canada, OTA Workshop on Site-Specific Technologies for Exploring the Exclusive Economic Zone, July 1986.

⁹⁹Ryall, "Remote Drilling Technology."
¹⁰⁰R. E. Davis, D. L. Williams, and R. P. Von Herzen, "ARPA Rock Drill Report," Woods Hole Oceanographic Institution, Technical Report 75-28, June 1975.

¹⁰¹Ryan, "Remote Drilling Technology."

Figure 4-15.-Conceptual Design for Deep Ocean Rock Coring Drill

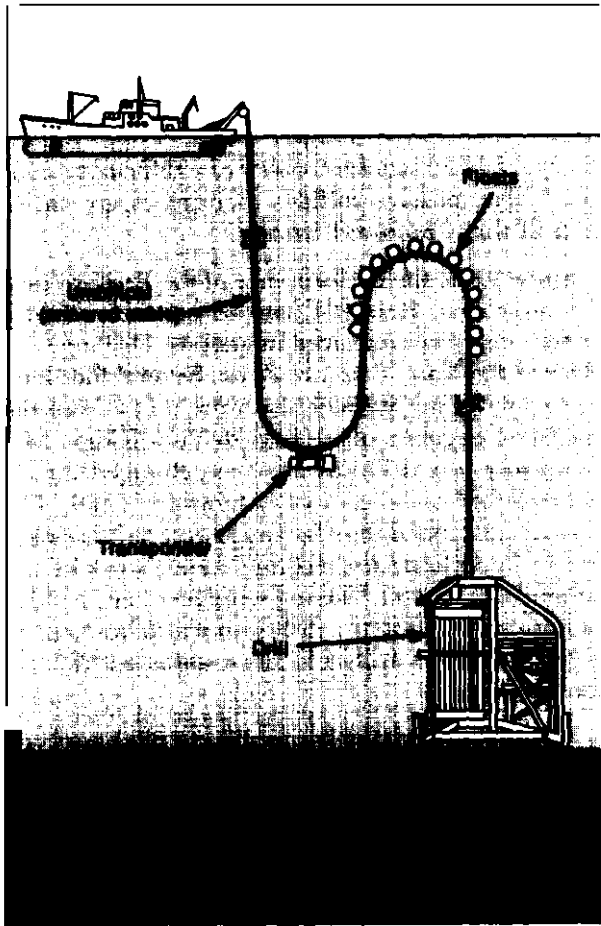

An alternative and less expensive approach to using a large and expensive drill ship for hard rock sampling is to use a remotely operated submersible drill which is lowered by cable from a surface vessel to the seafloor. (Not to scale).

SOURCES: Williamson & Associates, Inc., and Sound Ocean Systems, Inc.

rock corer was recently started by Sound Ocean Systems & Williamson and Associates (figure 4-15).¹⁰² This corer has not been built, but in concept it is similar to the Bedford drill. A major difference is that it is designed to core continuously to a depth of 53 meters (175 feet) (by adding core barrels from a storage magazine). Alternatively, it can be configured to recover 40 1.5-meter cores in a single deployment. A workable system for obtaining cores longer than 1 meter would be a significant advancement. Both ODP and Bedford drillers have experienced jamming beyond the first few meters and have not been able to obtain longer cores.

Very little sampling of sediment-hosted sulfides (e.g., in the Escanaba Trough off the coast of northern California) has been attempted yet. Today's percussion and vibratory devices rated for deep water use probably will be suitable for shallow sampling of sediment hosted sulfides but not for deeper drilling. Additional problems may occur if the water temperature is above 250 °C. Hot water could cause a good core to turn to homogenized muck as a sample is retrieved. Current technology also is not capable of doing downhole sampling (e. g., using a temperature probe) if the temperature is above 250 °C. If the water temperature is above 350 °C, embrittlement of the drill string could occur.

¹⁰²Petters and Williamson, "Design for Deep-Ocean Rock Core Drill."

NAVIGATION CONCERNS

Technology for navigation and positioning is essential in all marine charting and exploration work. The accuracy required varies somewhat depending on the purpose, but, for most purposes, present technology for navigating and for positioning a ship on the surface is considered adequate. Most seafloor exploration can be done quite well with local systems with internal uncertainties on the order of 10

meters and uncertainties relative to global coordinates of a kilometer or so. Use of a navigation system that can position a ship within 1 kilometer of a target would enable a ship to return to the immediate vicinity of a survey area or mine site, for example. Use of a system that could reliably position one within 10 meters relative to local coordinates (established, for example, by transponders

placed on the seafloor) would enable one to return to within visual range to photograph or take samples.¹⁰³

Gravity surveys and seismic reflection surveys do present demanding navigational requirements. For detailed gravity surveys, the velocity of the measuring instrument must be known with uncertainties less than 0.05 meter/second. For seismic work, the quality of the data is directly related to the positioning accuracy of the sequence of shots and the streamer hydrophores. Three-dimensional seismic surveys for exploration geophysics require positioning precision on the order of 10 centimeters over a survey area of about 100 square kilometers.¹⁰⁴ In some instances (e. g., determining relative motion of oceanic plates) accuracy on the order of 1 centimeter is important, but exploration technologies generally do not require this high degree of precision.

Precise positioning and tracking of remote systems, such as towed "fish" or ROVs, is also considered challenging. Positioning is usually done by acoustic rather than electromagnetic systems. Long baseline systems employ three or more fixed-bottom or structure-mounted reference points (e. g., acoustic transponders), while short baseline systems employ three or more ship-mounted transducers that receive an acoustic pulse from a subsea acoustic source.¹⁰⁵

Accurate marine charting requires precise navigational control relative to global coordinates. Although requirements are stringent, the state-of-the-art is sufficient for producing high-quality bathymetric charts. The National Ocean Survey (NOS) has established a "circular error of position" standard of 50 meters (164 feet) or better (in compliance with international standards for charting). This is about the average for survey ships operating beyond the range at which navigation technologies can be frequently calibrated. Accuracies of 5 to 10 meters are typical with calibrated equipment.¹⁰⁶

NOS, for example, uses ARGO and Raydist systems for charting work within about 120 miles of the coast, where these systems may achieve horizontal position accuracies of 5 to 10 meters. They are cumbersome to use, however, because they require special onshore stations to be set up and must be calibrated by a more precise system, such as a line-of-sight system like Mini-Ranger.¹⁰⁷ Beyond about 120 miles of the coast, these systems are unable to reliably meet NOAA's 50-meter standard. Far offshore, only the Global Positioning System (GPS) is capable of meeting the desired accuracy for charting.

LORAN-C is a commonly used ground-based navigation system. LORAN-C coverage is available within most of the U.S. EEZ, and it is accurate relative to global coordinates to within 460 meters. Users who want to return to a site whose coordinates have been measured with LORAN-C can expect to return to within 18 to 90 meters (60 to 295 feet) of the site using LORAN-C navigation; 18 to 90 meters is thus the system's repeatable accuracy. LORAN-C is expected to be phased out once the GPS is fully operational. However, this is not expected to occur before 2000. Once GPS is fully operational, plans call for a 15-year transition period during which both LORAN-C and GPS will be available. A satellite system available for civilian use is TRANSIT. This system is often used to correct for certain types errors generated by LORAN-C.

GPS is a satellite navigation system intended for worldwide, continuous coverage. When fully deployed, the system will consist of 18 satellites and three orbiting spares. Only six R&D satellites are operating now, and, due to the interruption in the space shuttle launch schedule, deployment of the operational satellites has been delayed about 2 years. The system is now scheduled to be fully deployed by 1991. Some of the current R&D satellites may also be used in the operational system. Costs to use the GPS are expected to be less than costs to use current systems.

GPS is designed for two levels of accuracy. The **Precise Positioning Service**, limited to the military and to users with special permits (NOS, for in-

¹⁰³National Research Council, *Seafloor Referenced Positioning: Needs and Opportunities* (Washington, DC: National Academy Press, 1983), p. 6.

¹⁰⁴Ibid., pp 8-10.

¹⁰⁵Frank Busby, *Undersea Vehicles Directory—1985* (Arlington, VA: Busby Associates, Inc., 1985), pp. 426-430.

¹⁰⁶Perry, "Mapping the Exclusive Economic Zone."

¹⁰⁷Ibid., p. 1192.

stance), is accurate to 16 meters or better. GPS accuracy to within 10 meters is considered routine. The less precise Standard Positioning Service is primarily for civilian use and is accurate to within about 100 meters. (Use of GPS, as well as LORAN-C and other systems in the differential mode—in which a ground receiver at a known location is used to check signals and measure range errors, allows higher accuracies to be achieved but takes much

longer). NOS uses GPS when it can to calibrate the other systems it uses (Raydist and ARGO). GPS is currently available about 4 hours a day; however, it is impractical to go to sea for just the short period in which the 'window' is open. Consequently, in the near term, NOS is focusing its survey work on the inner half of the EEZ where Raydist and ARGO can be used.

Chapter 5
Mining and At-Sea
Processing Technologies

Mining and At-Sea Processing Technologies

INTRODUCTION

Many factors influence whether a mineral deposit can be economically mined. Among the most important are the extent and grade of a deposit; the depth of water in which the deposit is located; and ocean environment characteristics such as wave, wind, current, tide, and storm conditions. Offshore mineral deposits range from unconsolidated sedimentary material (e. g., marine placers) to consolidated material (e. g., cobalt-rich ferromanganese crusts and massive sulfides). They may occur in a variety of forms, including beds, crusts, nodules, and pavements and at all water depths. Deposits may either lie at the surface of the seabed or be buried below overburden. Some deposits may be attached solidly to nonvaluable material (as are cobalt-rich crusts), while others (gold) may lie atop bedrock or at the surface of the seabed (manganese nodules). The amount and grade of ore can vary significantly by location.

All of these variables affect the selection of a mining system for a given deposit. Dredging is the most widely used technology applicable to offshore mining. Dredging consists of the various processes by which large floating machines or dredges excavate unconsolidated material from the ocean bottom, raise it to the surface, and discharge it into a hopper, pipeline, or barge. Waste material excavated with the ore may be returned to the water body after removal of valuable minerals. Dredging techniques have long been applied to clearing sand and silt from rivers, harbors, and ship channels. Application of dredging to mining began over a century ago in rivers draining the southern New Zealand gold fields. Offshore, no minerals of any type have been commercially dredged in waters deeper than 300 feet, and very little dredge mining has occurred in water deeper than 150 feet. Offshore dredging technology is currently used to recover tin, diamonds, sea shells, and sand and gravel at several locations around the world (table 5- 1).

Some of the problems of marine mining are common to all offshore deposits. Whether one considers mining placers or cobalt-rich ferromanganese crusts, for instance, technology must be able to cope with the effects of the ocean environment—storms, waves, currents, tides, and winds. Other problems are specific to a deposit or location (e. g., the presence of ice) and hence require technology specially designed or adapted for that location.

Just as many variables influence offshore mineral processing. The processing scheme must be designed to accommodate the composition and grade of ore mined, the mineral product(s) to be recovered, and the feed size of the material. Mineral processing technology has a long history onshore. Applications offshore differ in that technology must be able to cope with the effects of vessel motion and the use of seawater for processing. Technologies currently applied to processing minerals at sea are all mechanical operations and include dewatering, sizing, and gravity separation. Processing at sea is currently limited to the separation of the bulk of the waste material from the useful minerals. This may be all the processing required for such products as sand and gravel, diamonds, and gold; however, many other products, including, for example, most heavy minerals, require further shore-based processing. Chemical treatment, smelting, and refining of metals have heretofore taken place on shore, and, given the difficulty and expense of processing beyond the bulk concentrate stage at sea, are likely to continue to be done on land in most cases.

The degree to which processing at sea is undertaken depends on economics as well as on the capabilities of technology. As with mining technology, some processing technology is relatively well developed (e. g., technology for extracting precious metals or heavy minerals from a placer) while other technology is unlikely to be refined for commercial use in the absence of economic incentives.

Table 5-1.—Offshore Mineral Mining Worldwide Commercial Operations

Location	Mineral	Water depth (feet)	Mining method	Processing	Number of mining units	Remarks
Active:						
Phuket, Thailand	Tin	100	Bucket dredging	Gravity/jigs	2	
Billiton, Indonesia	Tin	35-180	Bucket dredging	Gravity/jigs	18	
Palau Tujuh, Indonesia	Tin	150	Bucket dredging	Gravity/jigs	1	
North Sea, UK	Sand & gravel	65	Hopper dredging	Dewatering only	12	
Southwestern Africa (Namibia)	Diamonds	50-490	Water jet suction	airlift Gravity/jigs	5	Pilot plant mining
Southwestern Africa	Diamonds	0-50	Diver-held suction	Gravity/jigs	10	Very small scale
Norton Sound, Nome, Alaska	Gold	35-65	Bucket dredging	Gravity/jigs	1	Pilot mining in 1986 with Bima Motion Compensation of Bucket Ladder
Reykjavik, Iceland	Sea shells	130	Hopper dredge	Dewatering only	1	
Nationwide, Japan	Sand & gravel		All techs	Dewatering only	500	Small units (1,000m ³)
Bahamas	Calcium carbonate	0-35	Suction dredge	Dewatering	1	
<i>Inactive or Terminated</i>						
Philippines	Gold		Bucket			
Korea	Gold		Bucket			
Japan	Iron sands		Grab			
Thailand	Tin		Suction dredge			
UK	Tin		Suction dredge			

SOURCE Office of Technology Assessment, 1987

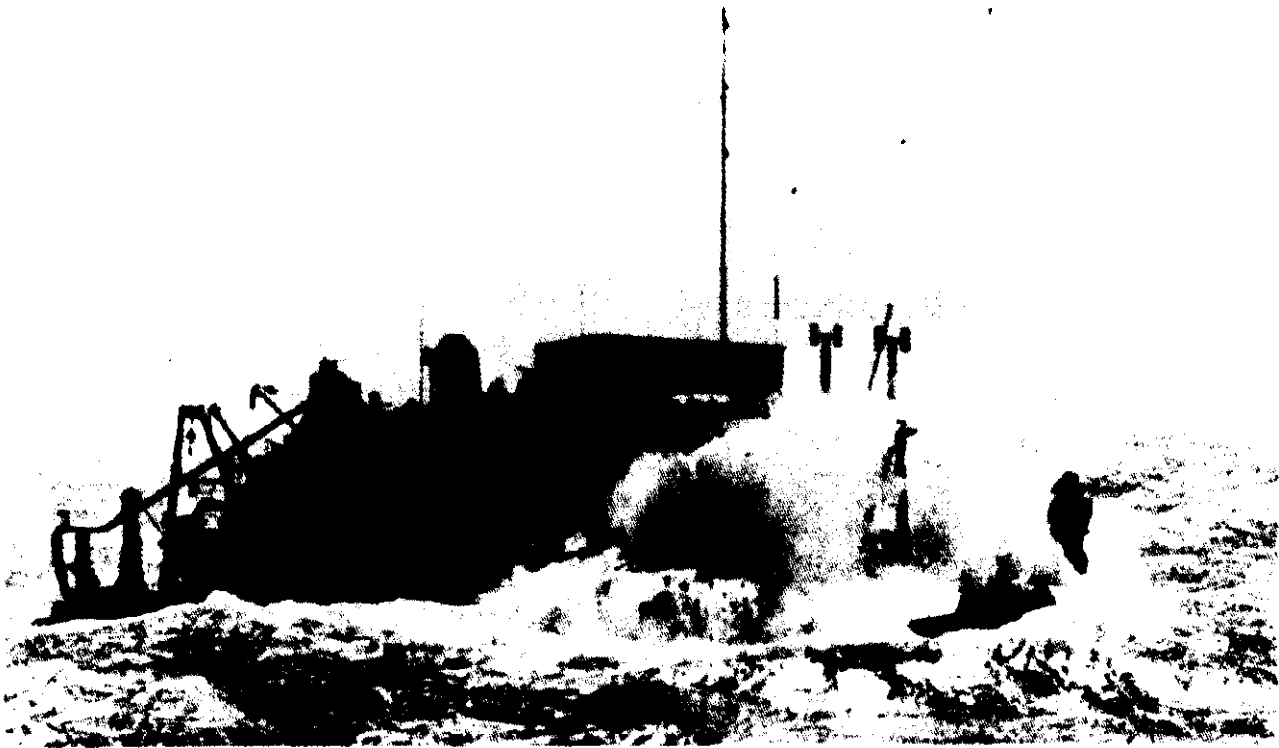

Photo credit: M.J. Cruickshank, U.S. Geological Survey

Dredge technology for offshore mining must be designed for rough water conditions.

DREDGING UNCONSOLIDATED MATERIALS

The dredge is the standard technology for excavating unconsolidated materials from the seafloor. Compacted material or even hard bedrock also can be removed by dredging, provided it has been broken in advance by explosives or by mechanical cutting methods. Dredges are mounted on floating platforms that support the excavating equipment. Mining dredges may also have equipment on board to handle and/or process ore.

Three principal dredging techniques are: bucketline, suction, and grab (table 5-2). For bucketline and suction dredging, the material is continuously removed from the seabed and lifted to the sea surface. Grab dredges also lift material to the surface, but in discrete, discontinuous quantities.

Most existing mining dredges are designed to operate in relatively protected waters. Dredge mining offshore in open water occurs in only a few

countries (Southwest Africa, United Kingdom, Indonesia, Thailand). The *Bima*, a mining dredge built for tin mining offshore Indonesia, is being adapted at this time for gold mining offshore Nome, Alaska. Little special equipment capable of mining the U.S. Exclusive Economic Zone (EEZ) has yet been built, although some feasibility studies and tests have been conducted.

Bucketline or Bucket Ladder Dredging

The bucketline or bucket ladder dredge consists of a series of heavy steel buckets connected in a closed loop around a massive steel ladder (in the manner of the chain on a chain saw) (figure 5-1). The ladder is suspended from a floating platform. For mining, the ladder is lowered until the buckets scrape against the dredging face, where each bucket is filled with ore as it moves forward. The buckets

Table 5-2.-Currently Available Offshore Dredging Technology

Type	Description	Present max dredging depth	Capacity
Bucketline and bucket ladder	"Continuous" line of buckets looped around digging ladder mechanically digs out the seabed and carries excavated material to floating platform.	164 feet	Largest buckets currently made are about 1.3 yd ³ and lifting rates 25 buckets per minute (1,950 yd ³ /hour with full buckets).
Suction	Pump creates vacuum that draws mixture of water and seabed material up the suction line.	300 feet	Restricted by the suction distance unless the pump is submerged,
Cutter head Trailing hopper	Mechanical cutters or high pressure water jets disaggregated the seabed material; suction continuously lifts to floating platform.	50-300 feet	Many possible arrangements all based on using a dredge pump; the largest dredge pumps currently made have 48" diameter intakes and flow rates of 130 to 260 yd ³ /min of mixture (10 to 20% solids).
Airlifts	Suction is created by injecting air in the suction line.	10,000 feet	Airlifts are not efficient in shallow water. There may be limitations in suction line diameter when lifting large fragments.
Grab: Backhoe/dipper	Mechanical digging action and lifting to surface by a stiff arm.	100 feet	Restricted by the duration of the cycle and by the size of the bucket; currently largest buckets made are 27 yd ³ .
Clamshell/ dragline	Mechanical digging action and lifting to surface on flexible cables.	3,000 feet	The largest dragline buckets made are about 200 to 260 yd ³ /hr; power requirements and cycle time increase with depth.

SOURCE: Office of Technology Assessment, 1987.

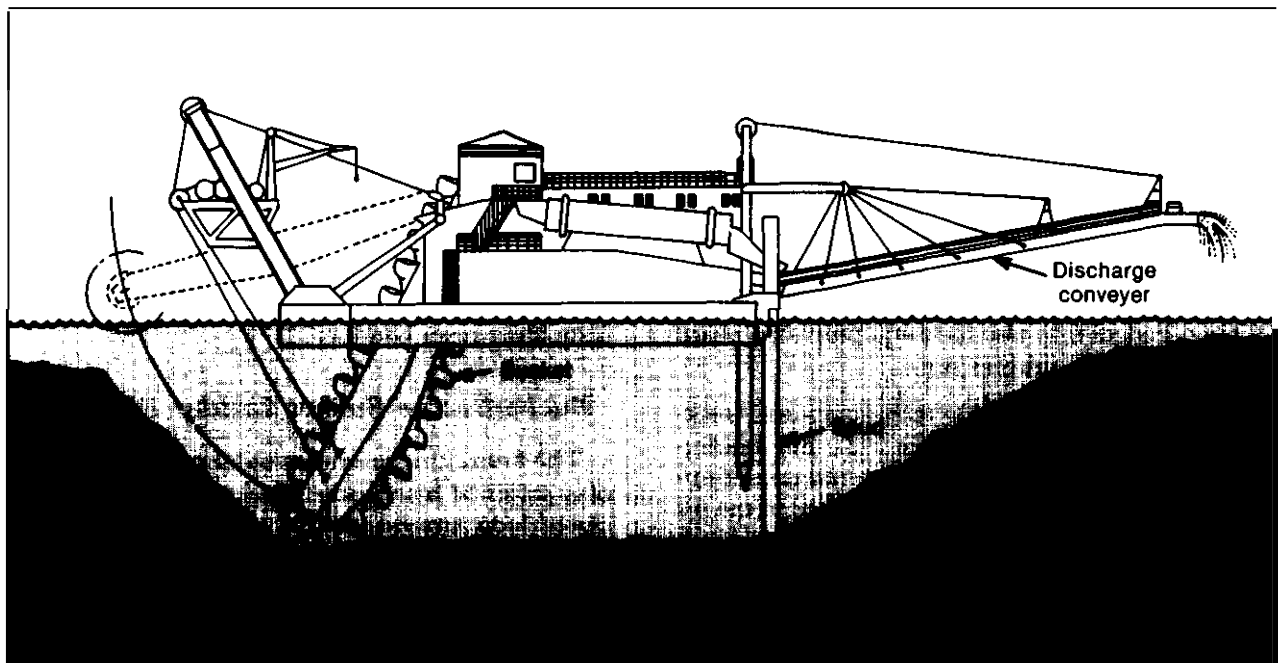
Figure 5-1.—Bucket Ladder Mining Dredge

The bucket ladder dredge is a proven and widely used dredge for offshore mining; however, its use to date has been limited to calm, shallow water.

SOURCE: M.J.Cruickshank, U.S. Geological Survey.

traveling up the ladder lift the material to the platform and discharge the ore into the processing plant.

The bucket ladder dredge is the most proven and widely used technology for mining offshore tin placers in open water in Southeast Asia. Bucket ladder dredges are widely used to mine onshore gold, platinum, diamonds, tin, and rutile placers in Malaysia, Thailand, Brazil, Colombia, Sierra Leone, Ghana, New Zealand, and Alaska. Bucket ladder dredge technology is still the best method to “clean” bedrock, which is particularly important for the recovery from placer deposits of heavy, high-unit-value minerals like gold and platinum. These dredges have buckets ranging in size from 1 to 30 cubic feet. The deepest digging bucket line dredges are designed to dig up to 164 feet below the surface.

Prices of bucket ladder dredges (including processing plants) for mining onshore vary with dredge capacity (bucket size) and with dredging depth. A small bucket dredge (with 3-cubic-foot buckets) may sell for approximately \$1.5 million (free on board plant). Such a dredge can mine 60,000 to 80,000 cubic yards of ore per month at depths of 30 to 40 feet below the hull. The cost of larger onshore mining bucket dredges (with buckets as large as 30 cubic feet) and capacities up to 1 million cubic yards per month may reach \$10 million to \$20 million, depending on digging depth and other variables.

The per-cubic-yard capital and operating costs of larger dredges are lower than those of smaller dredges (figure 5-2). Offshore bucket ladder dredges cost more than onshore dredges because they must be more self-contained. They must be built to carry a powerplant, fuel, supplies, and mined ore. The hull also must be larger and heavier to withstand waves and to meet marine insurance specifications. In 1979, the capital cost of the 30-cubic-foot *Bima* was about \$33 million. Approximately 10 bucket dredges configured for offshore use are currently mining tin in Indonesia in water depths of 100 to 165 feet at distances of 20 to 30 miles offshore.

Despite their versatility, offshore uses of bucket ladder dredges are limited. Much of the EEZ around the United States is subject to waves and ocean swells that could make bucket ladder dredging difficult. To ensure that the lower end of the ladder maintains constant thrust against the cut-

Figure 5.2.—Capital and Operating Costs for Bucket Ladder Mining Dredges

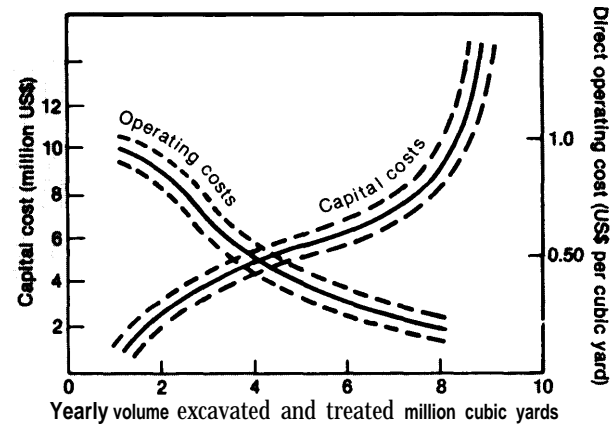

Dredges for use offshore would cost more to build and operate than the estimates illustrated here, since they would have to be self-contained and contain a power plant, fuel, supplies, and mined ore. They would also have to be capable of withstanding waves and high winds.

SOURCE: Adapted from M. J. Richardson and E. E. Horton, “Technologies for Dredge Mining Minerals of the Exclusive Economic Zone,” contractor report prepared for the Office of Technology Assessment, August 1986

ting face, motion compensation systems must be installed. These systems are large hydraulic and air cylinders that act like springs to allow the end of the ladder to remain in the same place while the hull pitches and heaves in swells (figure 5-3). Other limitations of current dredges include the high wear rate of the excavating components (e. g., buckets, pins, rollers, and tumblers) and the lack of mobility. Offshore bucket dredges are not self-propelled and must be towed when changing locations. For long tows across rough water, the ladder makes the vessel unseaworthy and makes towing impractical. The bucket dredge *Bima* was actually carried on a submersible lift barge from Indonesia to Alaska. In designing offshore dredges, especially those working in rough water, careful attention must be given to seaworthiness of the hull.

Most bucket ladder dredges are now built outside the United States, although the capability and know-how still exist in this country. Except for the motion compensation systems installed on offshore dredges, bucket ladder dredge technology has remained essentially static, and there have been only minor gains in dredging depth in the last 50 years.

Figure 5-3.—Motion Compensation of Bucket Ladder on Offshore Mining Dredge

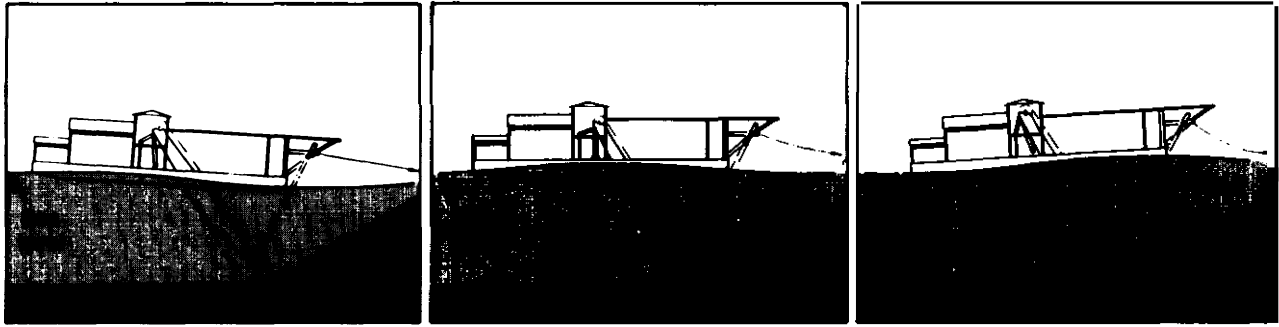

Motion compensation systems might be necessary offshore to ensure that the lower end of the dredge ladder maintains constant thrust against the cutting face while the dredge hull pitches and heaves in swells.

SOURCE: Dredge Technology Corp.

With the availability of new materials and higher strength steels, it is now possible to design bucket ladder dredges capable of digging twice as deep (330 feet) as present dredges, but the capital and operating costs would be greatly increased.

Suction Dredging

Suction dredging systems have three principal components: a suction device, a suction line, and a movable platform or vessel (figure 5-4). The suction device can be either a mechanical pump or an airlift. Pumps are most common on suction dredges; airlifts have more specialized applications. Pumps create a drop in pressure in the suction line. This pressure drop draws or sucks in a mixture of seawater and material from the vicinity of the suction head and up the suction line into the pump. After the slurry passes through the pump, it is pushed by the pump along the discharge pipe until it reaches the delivery point.

Pump technology is considered relatively advanced. Dredge pumps are a specialized application. The main features required of dredge pumps are large capacity, resistance to abrasion, and efficiency. To accommodate the large volumes of material dredged, the largest dredging pumps have intakes of up to 48 inches in diameter and impellers up to 12 feet in diameter. These parts require large steel castings that are both costly and complicated to make. The flow of solids (e. g., silicate sand or gravel) and water at speeds of 10 to 20 feet per second through the pump and suction line causes abrasion and wear.

Figure 5-4.—Components of a Suction Dredge

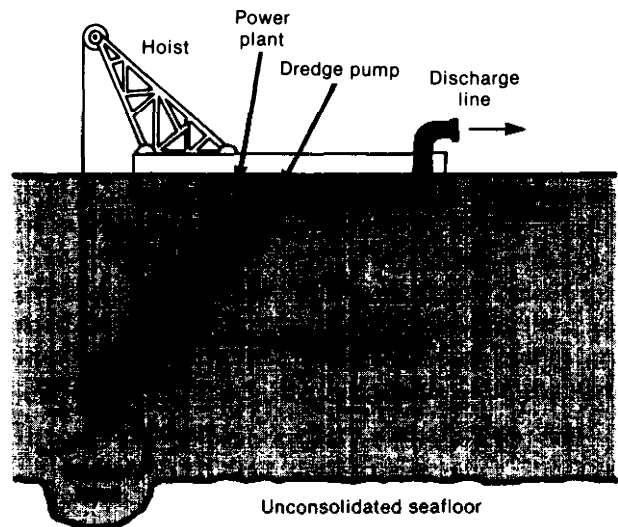

The main types of suction dredges currently applicable to offshore mining are hopper, cutter head, and bucket wheel dredges.

SOURCE: Office of Technology Assessment, 1957.

Pumps create suction by reducing the pressure in suction lines below atmospheric pressure. Only 80 percent of vacuum can be achieved using present mechanical pumping technology. This constraint means that dredge pumps cannot lift pure seawater in the suction line more than about 25 feet above the ocean level. This distance would be less for a mixture of seawater and solids and would vary with the amount of entrained solids. Greater efficiency can be achieved by placing the pump below the water line of the vessel, usually as near as possible

to the seabed. This placement is more costly, since the pump is either a long distance from the power source or the pump motors must be submerged. Such components are very heavy for large pump capacities. An alternative applicable for deep dredging is to use several pumps in series and boost the flow in the suction line by means of water jets. This technique has been tested and proven but is not in widespread use because it is inefficient.

The configuration of the suction head plays an important role by allowing the passage of the solids and water mixture up the suction line. In harder, more compact material, the action of the suction head may be augmented by rotary mechanical cutters, by bucket wheels, and/or by water jets, depending on the specific applications. When the material to be dredged is unhomogeneous, such as sand and gravel, the entrance of the suction line is restricted to prevent foreign objects (e. g. large boulders) from entering the suction line. The main technological constraints in suction and discharge systems are wear and reliability due to corrosion, abrasion, and metal fatigue.

The platform or vessel that supports suction dredging components must be able to lift and move the suction head from one location to another. Since most dredgeable underwater mineral deposits are more broad than thick, the dredge must have the capability to sweep large areas of the seabed. This is achieved by moving the platform, generally a floating vessel; although experimental, bottom-supported suction dredges have been built and tested.

The main types of suction dredges currently applicable to offshore mining in the EEZ are hopper, cutter head, and bucket wheel dredges.

Hopper Dredges

Hopper dredges usually are self-propelled, sea-going suction dredges equipped with a special hold or hopper in which dredged material is stored (figure 5-5). Dredging is done using one or two dredge pumps connected to trailing drag arms and suction heads. As the dredge *moves* forward, material is sucked from the seabed through the drag arms and emptied into the hopper. Alternatively, the dredge may be anchored and used to excavate a pit in the deposit.

Hopper dredges are used mainly to clear and maintain navigational channels and harbor entrances and to replenish sand-depleted beaches. In the United Kingdom and Japan, they are also used to mine sand and gravel offshore. Hopper dredges are configured to handle unconsolidated, free-flowing sedimentary material. The suction heads are usually passive, although some are equipped with high-pressure water jets to loosen seabed material. The trailing drag arms are usually equipped with motion compensation devices and gimbal joints. These devices allow the drag arms to be decoupled from vessel motion and enable the dragheads to remain in constant contact with the seafloor while dredging.

The dredged material is dewatered for transport after entering the hopper. Hopper dredges may discharge material through bottom doors, conveyor belts, or discharge pumps. Some models are emptied by swinging apart the two halves of an axially hinged hull.

Capacities of sea-going suction hopper dredges currently range from 650 to 33,000 cubic yards. Although the theoretically maximum-sized hopper dredge has not been built, the maximum capacity of present dredges is a compromise between the higher capital investment required for greater hopper capacity and the higher operating costs that would result from more trips with smaller hoppers. Typical operating depths for hopper dredges are



Photo credit: J. Williams, U.S. Geological Survey

Trailing suction hopper dredge *Sugar Island* with drag arms stowed and hopper space visible.

Figure 5-5.—Trailing Suction Hopper Dredge

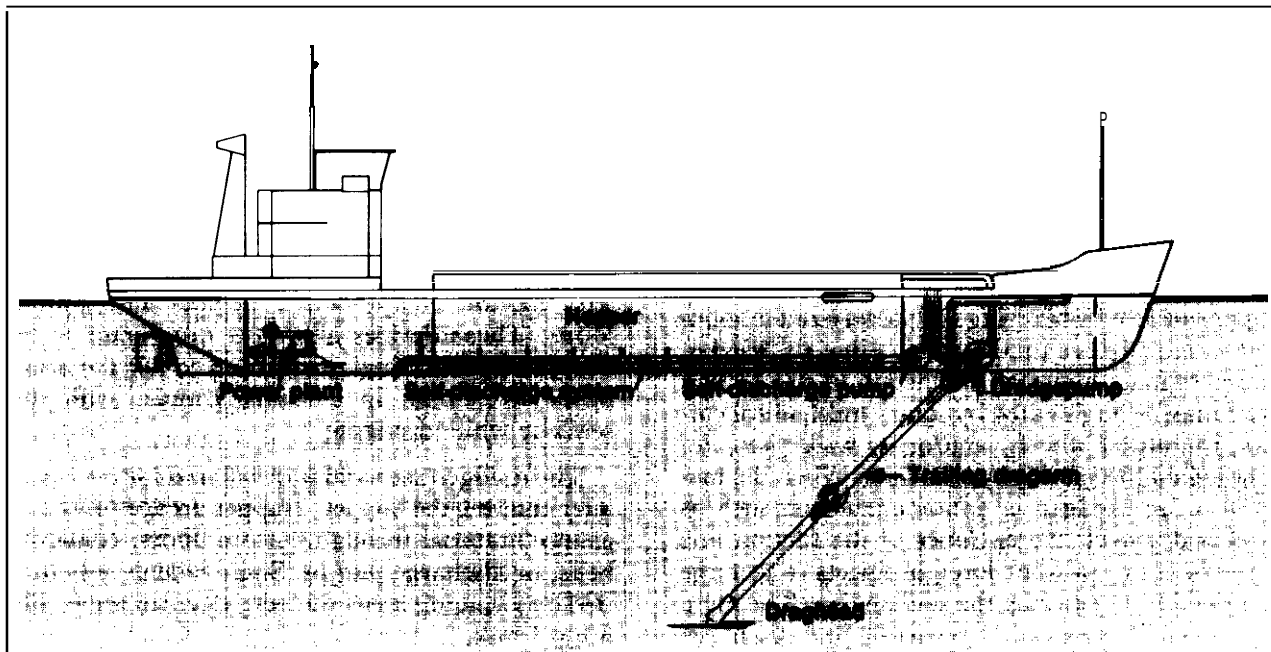

Hopper dredges have been used mainly to clear and maintain navigational channels and harbor entrances and to replenish sand-depleted beaches. A hopper dredge is currently being used to mine sand and gravel in the Ambrose Channel entrance to New York Harbor.

SOURCE: Dredge Technology Corp.

between 35 and 100 feet, and 260 feet is considered the maximum achievable depth with currently available technology. For current specifications and capacities, the capital costs of hopper dredges range from \$5 million to \$50 million.

Except for sand and gravel mining in Japan and the North Sea, hopper dredges have not been used extensively to recover minerals. However, hopper dredges adapted for preliminary concentration (beneficiation) of heavy minerals at sea, with overboard rejection of waste solids and water, are likely candidates for mining any sizable, thin, and loosely consolidated deposits of economic heavy minerals that might be found in water less than 165 feet deep.

A stationary suction dredge, similar in principle to the anchored suction hopper dredge, has been designed and extensively tested for mining the metalliferous muds of the Red Sea.¹ Although the

dredge has not been used commercially, it successfully retrieved muds in 7,200 feet of water.

Cutter Head Suction Dredges

Mechanically driven cutting devices may be mounted near the intake of some suction dredges to break up compacted material such as clay, clayey sands, or gravel. The two main types are cutter heads and bucket wheels.

Cutter head dredges are equipped with a special cutter (figure 5-6) mounted at the end of the suction pipe. The cutter rotates slowly into the bottom material as the dredging platform sweeps sideways, pulling against "swing lines" anchored on either side. Cutter head dredges usually advance by lifting and swinging about their spuds when in shallow water.

Cutter head dredges are in widespread use on inland waterways for civil engineering and mining projects. Onshore, these dredges have been used to mine heavy minerals, (e. g., ilmenite, rutile, and zircon) from ancient beaches and sand dunes in the

¹M.J. Cruickshank, "Technology for the Exploration and Exploitation of Marine Mineral Deposits, *Non-Living Marine Resources* (New York, NY: United Nations, Oceans, Economics, and Technology Branch), in press.

Figure 5.6.—Cutter Head Suction Dredge

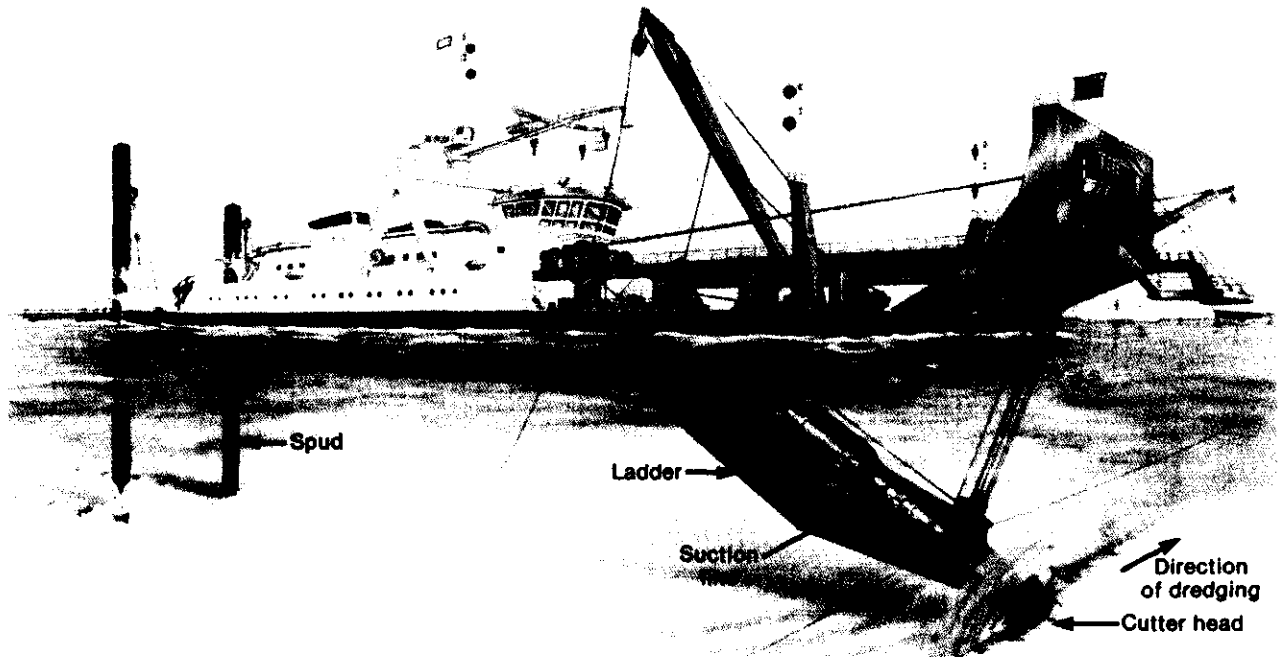

Dredges such as this have been used at inland mine sites to mine heavy minerals such as ilmenite, rutile, and zircon.

SOURCE: Dredge Technology Corp

United States (Florida), Australia (Queensland), and South Africa (Richards Bay). Ore disaggregate by the cutter is pumped through a flexible pipeline to a wet concentrating plant floating several hundred feet behind the dredge. This configuration, while common on protected dredge ponds inland, may not be suitable for mining in the open water of the marine environment because of wave, current, and wind conditions.

Large self-propelled cutter head suction dredges have been built that are capable of steaming in rough water with the cutter suction ladder raised. While not able to operate in heavy seas, this type of dredge can disengage from the bottom and “ride out” storms. Adaptation of a sea-going cutter head dredge to mining may require a motion compensated ladder and installation of onboard processing facilities and would require addition of a hopper or the use of auxiliary barges.

The capital costs of cutter head suction dredges vary widely with size and configuration. For sea-going, self-powered dredges the capital costs would be similar to those of hopper dredges, i.e., up to \$50 million. The capacities of cutter head dredges vary with the size of the dredge pumps, which range in diameter between 6 and 48 inches. This range of diameters corresponds to mining volumes of solids between 100 and 4,000 cubic yards per hour.

Like suction hopper dredges, the operating depths of available cutter head dredge designs are limited by dredge pump technology to between 35 and 260 feet, although greater mining depths could be achieved with incremental technical improvements. The cutter head suction dredge is not considered suitable for cleaning bedrock to recover gold or other very dense minerals in placer deposits, due to inefficiency in recovering the heavier minerals.

Figure 5-7.—Bucket Wheel Suction Dredge

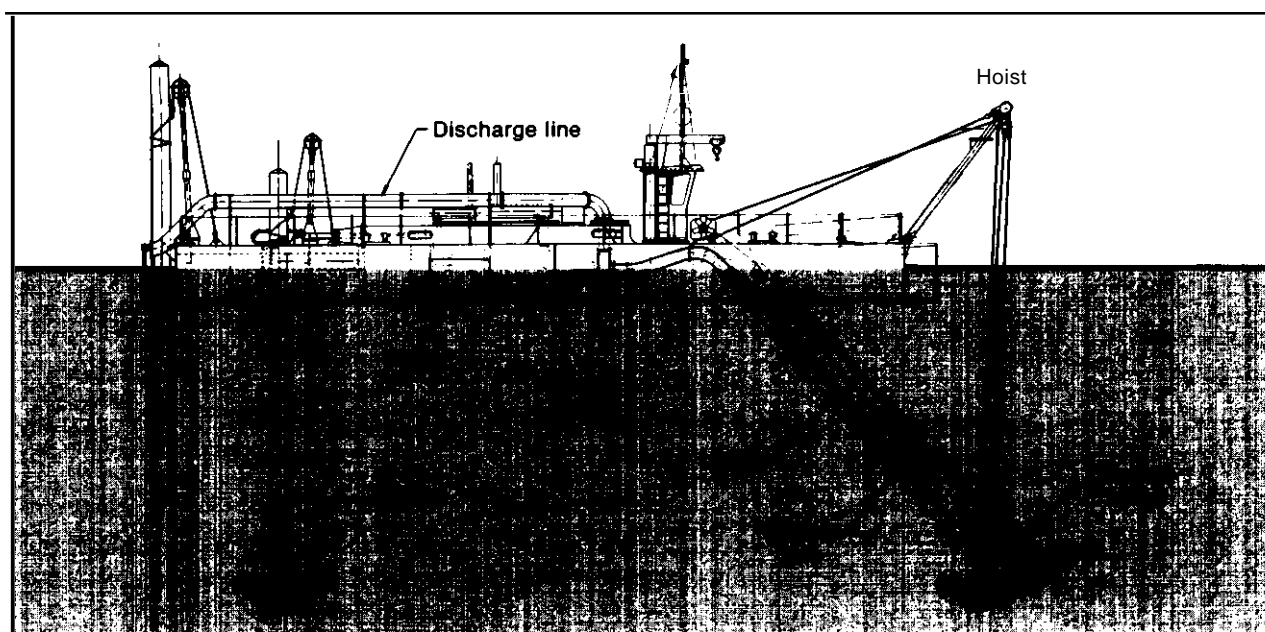

Bucket wheel dredges have been used primarily in calm inland waters. Equipped with motion compensation devices, these dredges may have some potential for mining offshore placer deposits.

SOURCE: Dredge Technology Corp.

Bucket Wheel Suction Dredges

The bucket wheel dredge (figure 5-7) is a variant of a cutter head dredge, differing mainly in that the cutter is replaced by a rotating wheel equipped with buckets that cut into the dredging face in a manner similar to a bucket ladder dredge. The buckets are bottomless and discharge directly into the suction line.

Bucket wheel mining dredges are a relatively new development and have been used primarily in calm inland waters. Some applications include tin mining in Brazil, sand and gravel mining in the United States, and heavy mineral mining in South Africa. The bucket wheel dredge has not been used in the EEZ, but it may have potential for mining offshore heavy minerals in specific applications. Motion compensation, offshore hull design, and mobility would need to be considered. These dredges are less effective when cutting clay-rich materials, which may clog the buckets, and when dredging boulders, which could block the opening into the suction lines. However, bucket wheel dredges are more suitable

than cutter head suction dredges for mining heavy minerals, since the bucket wheel avoids the problem of loss of heavy minerals on the bottom.

Air Lift Suction Dredges

In airlift suction dredging, air under pressure is injected in the suction line of the dredge, substituting for the mechanical action of a dredge pump (figure 5-8) and creating suction at the intake which allows the upward transport of solids. Airlifts have been used for many years in salvage operations and, during the past 25 years, for mining diamond-bearing gravels off the southwestern coast of Africa.

The technology of airlift dredges has not reached the level of development and widespread use of the other forms of suction dredging, but the configurations are similar. Much research has been done on the physics of the flow of water, air, and solids mixtures in airlift suction dredging, because this method has been considered one of the most promising for dredging phosphorite or manganese nodules from great ocean depths. In general, applica-

Figure 5-8.—Airlift Suction Dredge Configuration

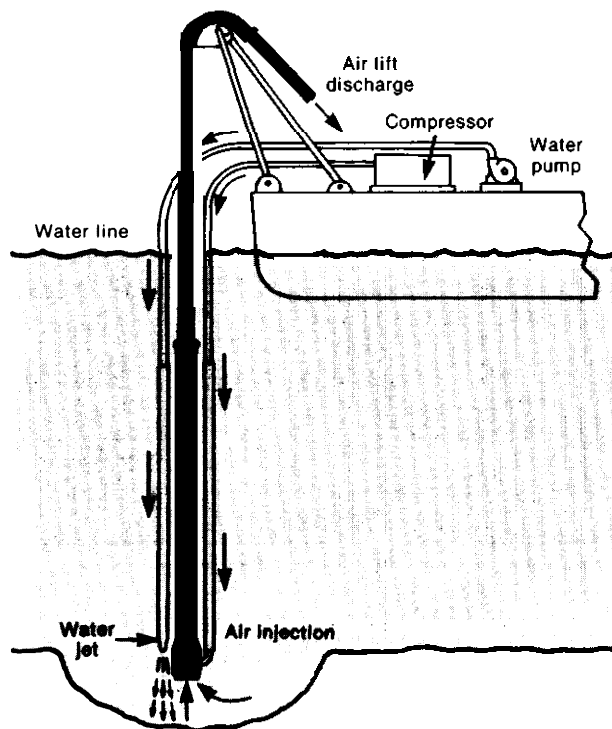

Airlift dredges may be applicable for some seabed deposits 300 feet or more below the ocean surface. Airlift dredging has been used on a pilot scale to lift manganese nodules from about 15,000 feet.

SOURCE: Office of Technology Assessment, 1987.

tions of airlifts for mining offshore minerals may be considered for depths between 300 and 16,000 feet. Suction and air delivery lines can be handled with techniques readily adapted from the petroleum industry; the problem of platform motion in response to long period waves can be overcome by adapting motion compensation systems used in the petroleum industry; and seabed material can be disaggregated at the suction intake by high-pressure water jets or by hydraulically driven mechanical cutters.

Grab Dredges

Grab dredging is the mechanical action of cutting or scooping material from the seabed in finite quantities and lifting the filled 'grab' container to the ocean surface. Grab dredging takes place in a cycle: lower, fill, lift, discharge, and again lower

the grab bucket. Clamshell, dragline, dipper, and backhoe dredges are examples of this technology (figure 5-9). Clamshells and draglines are widely used for dredging boulders or massive rock fragments broken by explosives and for removing overburden from coal and other stratified mineral deposits. The clamshell and dragline buckets are lowered and lifted with flexible steel cables. Variants of clamshell dredging have been used in Thailand to mine tin in Phuket Harbor and in Japan to mine iron sands in Ariake Bay. In the late 1960s, Global Marine, Inc., used a clamshell dredge for pilot mining of gold-bearing material from depths of 1,000 feet near Juneau, Alaska. Variants of dragline dredges have been used since the late 19th century to recover material from the deep seafloor.

With appropriate winch configurations for handling large amounts of cable and large buckets, grab dredging is similar to the traditional technologies used to hoist material from deep underground mines (e. g., in South Africa, where it is economically feasible to hoist gold ores from 12,000 feet below the ground surface). Most aspects of clamshell dredging technology, including motion compensation for working on a moving platform at sea, have been developed and proven by either the mining or petroleum industry and are readily available for adaptation to offshore mining.

Dipper and backhoe dredges are designed for use on land (figure 5-9). They may be placed on floating pontoons for offshore dredging but are limited to shallow-water applications. Backhoes especially can be easily adapted to mining in protected shallow water. Commercial off-the-shelf backhoes with a maximum reach of about 30 feet and buckets with capacities of up to 3 cubic yards are readily available for gold or tin placer mining in protected environments. Backhoes mounted on walking platforms are conceivable for excavation in shallow surf zones. Backhoe mining is limited by depth of reach, small capacity, and the inability of the operator to see the cutting action of the bucket below water. Dipper dredges are widely used to mine stratified mineral deposits (e. g., coal and bauxite) on land, but their unique action (figure 5-9) restricts offshore applications to shallow water. As dredged material using grab, dipper, and backhoe dredges is raised through the water column, the material is washed, which may not be desirable in mining.

Figure 5-9.—Grab Dredges

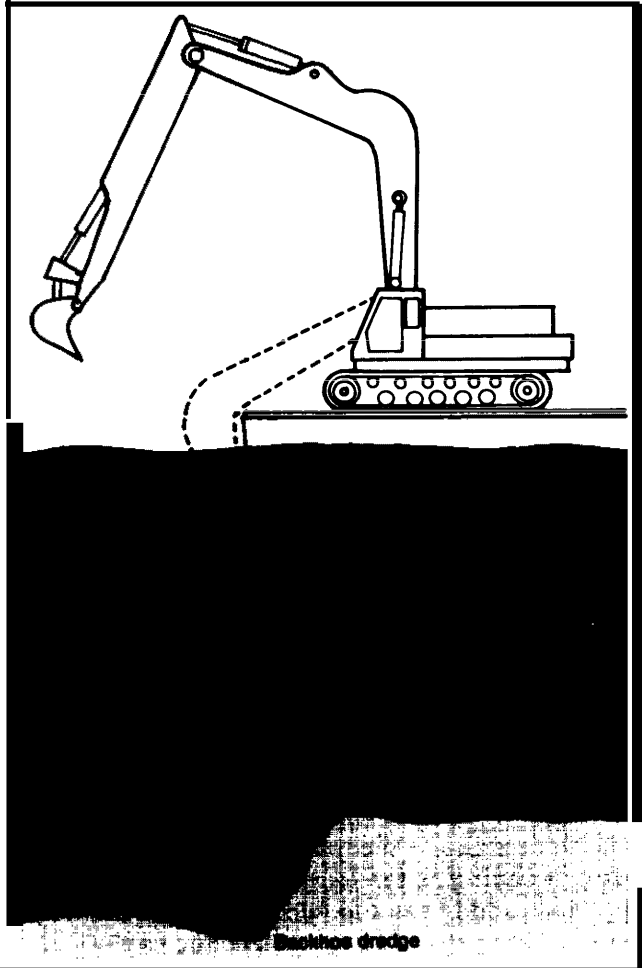
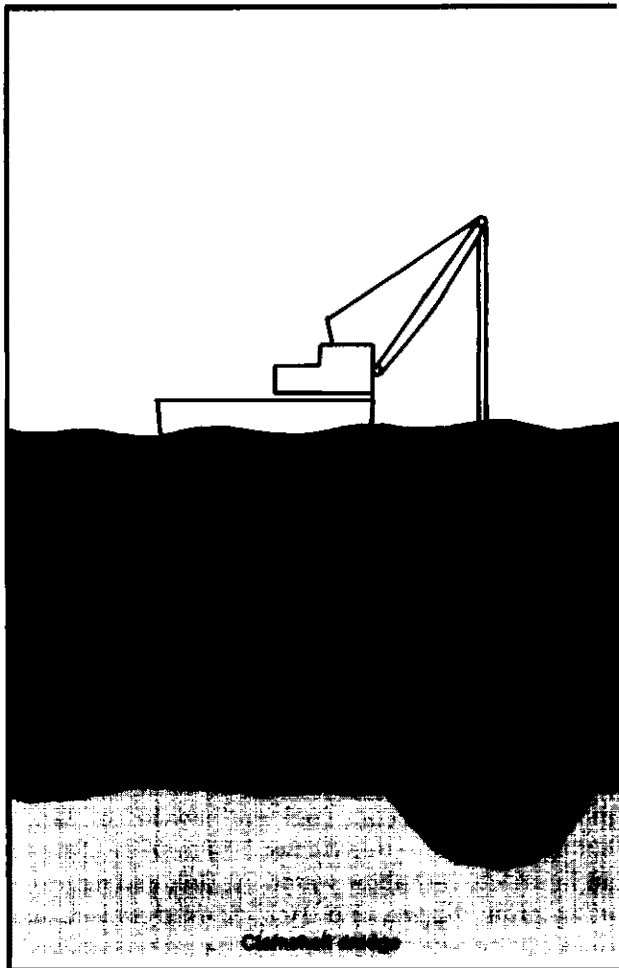
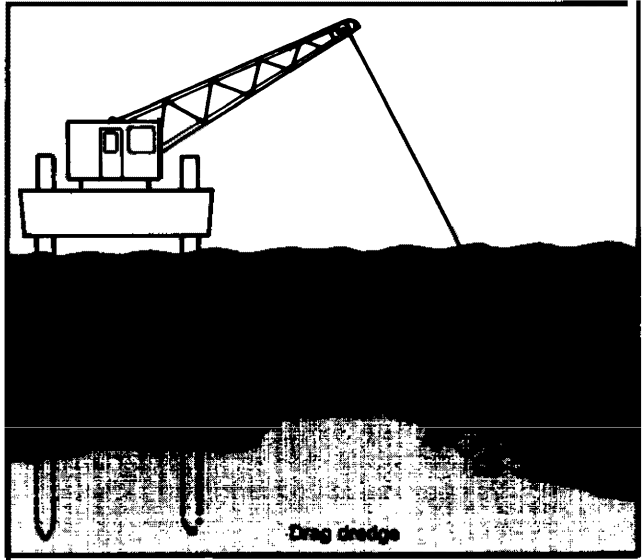
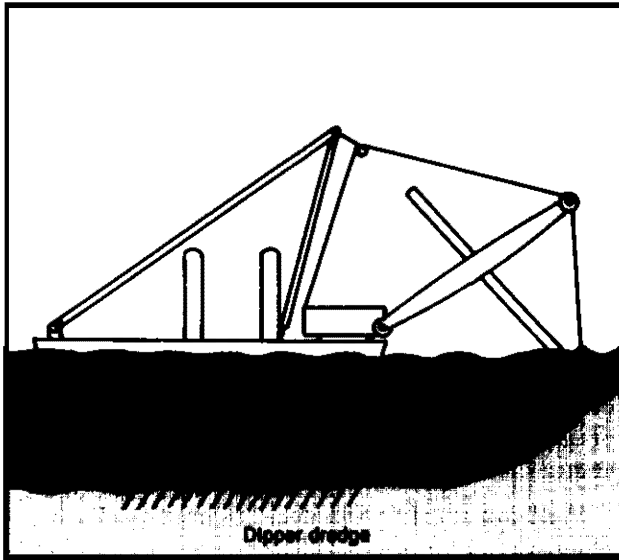

NEW DIRECTIONS AND TRENDS IN DREDGING TECHNOLOGY

Dredge technology for offshore mining falls into two distinct categories: technology for mining near-shore in shallow, protected water; and technology for further offshore in deeper water subject to winds, currents, and ocean swell. Dredging systems for a shallow environment can be readily adapted from the various types of dredges currently used onshore. Dredges for mining in a deep-water environment must be designed with special characteristics. They must be self-powered, seaworthy platforms equipped with motion compensation systems, onboard processing plants, and mineral storage capabilities.

Design and construction of offshore dredge mining systems for almost any kind of unconsolidated mineral deposit or environment on the continental shelf are possible without major new technological developments. However, for some environments, there may be operating limitations due to seasonal wave and storm conditions. No breakthroughs comparable to the change from the piston to the jet engine in the aircraft industry, for instance, are needed. If deposits of sufficient size and richness are found, incremental improvements in dredging technology can be expected. Costs to design, build, and operate dredging equipment for offshore mining are the most significant constraints.

Several new design concepts have been developed to help solve some of the problems of dredging at sea. The motion of platforms floating on the ocean generally make dredging difficult, but there are three ways to alleviate this movement other than those described previously. In one approach for shallow water, one firm has designed and built an eight-leg "walking and dredging self-elevating platform" (WADSEP) to support a cutter head suction dredging system (figure 5-10). By raising and translating one set of legs at a time the platform creeps slowly across the seafloor. Since the platform is firmly grounded, the problem of operating in rough, open water is reduced. The dredge ladder and cutter head sweep sideways by pulling against anchors. This self-elevating platform could equally well support a bucket ladder dredging operation. The practical limit for dredging using a WADSEP is probably about 300 feet. Although the concept and technology are sound, the WADSEP is not currently cost-effective to use.

Figure 5-10.—Cutter Head Suction Dredge on Self-Elevating Walking Platform

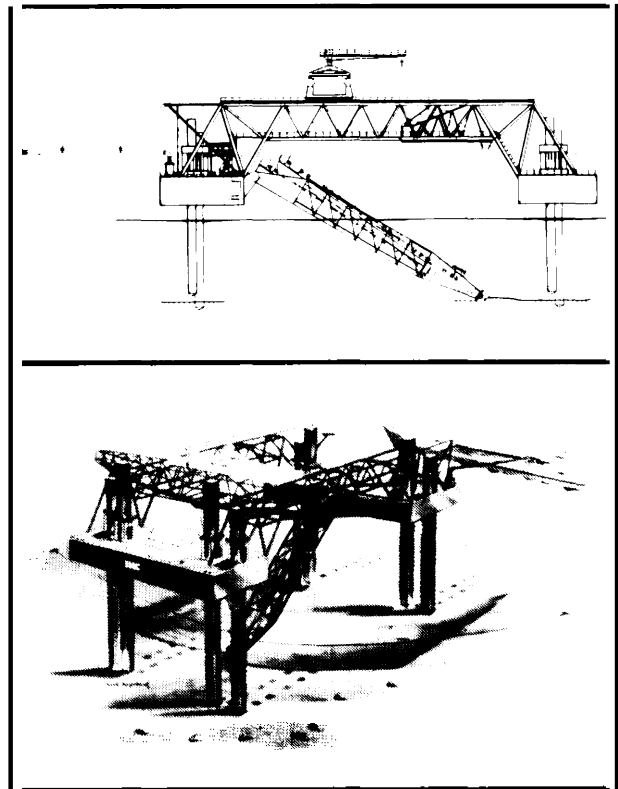

Although the technology is proven, mining operations with a self-elevating walking platform are currently very expensive.

SOURCE: Dredge Technology Corp.

A second technological approach to the problem of dredge motion in offshore environments is to use a semi-submersible platform, such as those in widespread use in the petroleum industry. This would enable a dredge to continue mining or to stay on-station rather than having to be demobilized during rough weather. A design for a suction dredge that incorporates a seaworthy semi-submersible hull is shown in figure 5-11. A disadvantage of the semi-submersible platform would be its sensitivity to large changes in deadweight if dredged material is stored on board.

A third approach to eliminating platform motion in shallow water is to develop a submerged dredge. This project has proved to be complex and difficult in systems tested to date. Although a prototype of a submerged cutter head suction dredge was

Figure 5-ii.—Conceptual Design for Suction Dredge Mounted on Semi-Submersible Platform

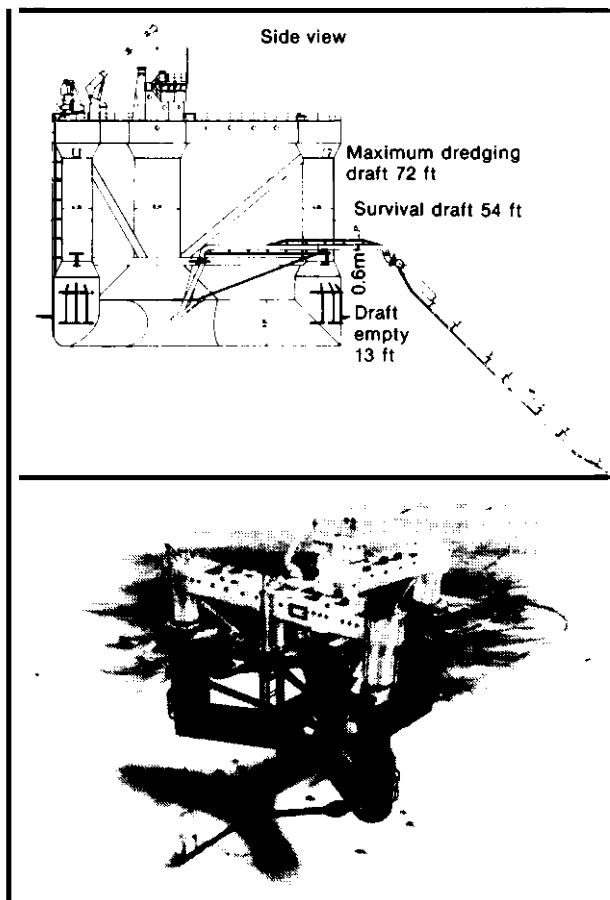

Semi-submersible platforms have been developed for offshore oil drilling. The semi-submersible platform offers a stable platform from which to operate, but is very expensive.

SOURCE: Dredge Technology Corp.

successfully built and operated offshore for several months, it was not an economic success and its development was discontinued.

Greater dredging depths can be attained by submerging pumping systems or by employing airlift or water jet lift systems. While submerged pump technology can be readily adapted from military submarine technology or from deep-water petroleum technology, the development costs are high.

No breakthroughs are foreseen that could vastly increase the capacities of offshore dredging systems and bring substantial cost reductions. However, existing technology is largely based on steel construction, and the use of new, lighter materials with higher strength-to-weight ratios has not been widely investigated.

MINING CONSOLIDATED MATERIALS OFFSHORE

Two principal types of consolidated deposits that are known to occur in the U.S. EEZ are massive polymetallic sulfides and cobalt-rich ferromanganese crusts. Alternatives for mining manganese nodules, where present in the EEZ, have much in common with dredging techniques used in shallow water, although the deep water in which nodules are found presents special problems. However,

techniques for mining polymetallic sulfides and cobalt crusts are likely to be very different than the dredging techniques used to mine placers and other unconsolidated deposits. Unlike unconsolidated deposits, these deposits must be broken up (using either some type of mechanical device or blasting) and possibly must be crushed prior to transport to the surface. Moreover, all known cobalt crust and

offshore polymetallic sulfide deposits occur in deep water, beyond the range of technologies used for conventional placer mining.

Much of the technology needed to mine massive polymetallic sulfide and cobalt crust deposits is yet to be developed. EEZ hard-rock deposits and massive polymetallic sulfide deposits are, therefore, probably of more scientific than commercial interest at this time. Research on the genesis, distribution, extent, composition, and other geological aspects of these deposits has been underway for only a few years, and more knowledge will likely be required before the private sector is likely to consider spending large sums of money to develop needed mining technology. A more immediate need is to refine the technology for sampling these hard-rock deposits (see ch. 4). Before mining equipment can be designed, more technical and engineering data on the deposits will be required.²

In the deep ocean, technology must be designed to cope with elevated hydrostatic pressure, the corrosive saltwater environment, the barrier imposed by the seawater column, and rugged terrain. Even onshore, mining equipment requires constant repair and maintenance. Given deep ocean conditions, it will be particularly important that mining equipment be as simple as possible, reliable, and sturdy.³

Massive Polymetallic Sulfides

Although technology for mining massive sulfides has not been developed, the steps likely to be required are straightforward. To start, any overburden covering the massive sulfides would have to be removed, although it is likely that initial mining targets would be selected without overburden. Then, the resource would then have to be fragmented, collected, possibly reduced in size, transported to a surface vessel, optionally beneficiated on the vessel, and finally transported to shore.

A number of conceptual approaches have been suggested to fragment and/or extract massive sulfides. These include use of cutter head dredges; drilling and blasting; high-pressure water jets; dozers, rippers, or scrapers; high-intensity shock waves; and in situ leaching.⁴ All proposed extraction methods have some drawbacks, and none have been tested in the ocean environment. Crushing or grinding, where required, is not technically difficult on land but has not yet been done in commercial operations on the seafloor. Transport of crushed ore to the surface would most likely be accomplished by hydraulic pumping (using either airlift or submerged centrifugal pumps). This technology has been studied for mining seabed manganese nodule deposits, so it is perhaps the most advanced submerged part of many proposed hard-rock mining systems.

No major technical innovations are expected to be needed for surface ship operations, although the cost of equipment such as dynamically positioned semi-submersible platforms will be expensive. On-board storage and transport of massive sulfide ore would have similar requirements as storage and transport of most other ores. Flotation technology for beneficiating massive sulfides has not yet been adapted for use at sea; however, the U.S. Bureau of Mines has initiated research on the subject.

One conceptual approach⁵ for deposits on or just below the seafloor envisions the use of a bottom-mounted hydraulic dredge (figure 5-12). The dredge would be equipped with a suction cutter-ripper head capable of moving back and forth and also telescoping as it cuts into the sulfide deposit and simultaneously fractures and picks up the material by suction. The dredged material would be first pumped from the seabed to a crusher and screen system, then into a storage and injection hopper on the submerged dredge, and finally from the injection hopper to the surface. An airlift pump and segmented steel riser would give vertical lift. The surface platform would be a large, dynamically positioned, semi-submersible platform. After dewatering, the pumped material would be discharged into storage holds on the platform. In concept, the ore would be beneficiated on the platform, loaded on a barge,

²R. Kaufman, "Conceptual Approaches for Mining Marine Polymetallic Sulfide Deposits," *Marine Technology Society Journal*, vol. 19, No. 4, 1985, p. 56.

³D. K. Denton, Jr., "Review of Existing, Developing, and Required Technology for Exploration, Delineation, and Mining of Seabed Massive Sulfide Deposits," U.S. Bureau of Mines, Minerals Availability Program, Technical Assistance Series, October 1985, p. 13.

⁴Ibid., pp. 16-17

⁵Kaufman, "Conceptual Approaches for Mining," pp. 55-56.

Figure 5-12.—Conceptual System for Mining Polymetallic Sulfides

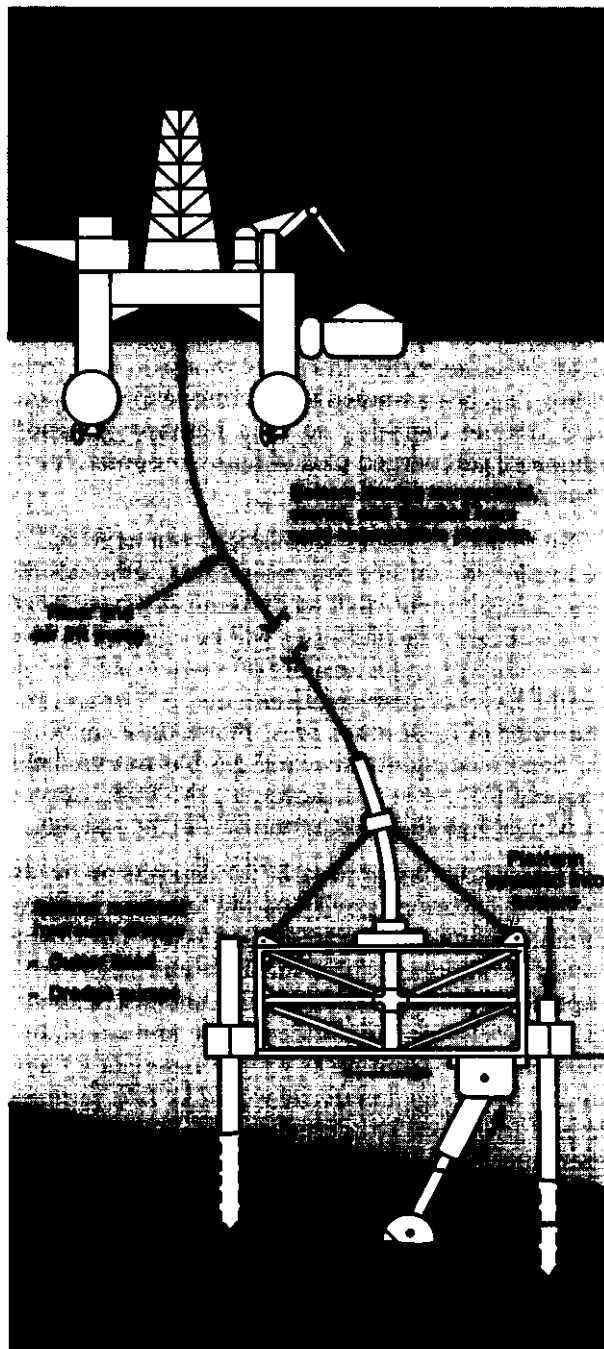

A prototype system for mining massive sulfides will unlikely be developed until the economics improve and more is known about the deposits (not to scale).

SOURCE: R. Kaufman, "Conceptual Approaches for Mining Marine Polymetallic Sulfide Deposits," *Marine Technology Society Journal*, Vol 19, No. 4, 1985, p. 56.

and finally transported to shore using a tug-barge system. While such approaches seem reasonable given the current state of knowledge, a prototype mining system may be very different. It will not be possible to develop such a system until more is known about the nature of massive sulfides and until there is a perceived economic incentive to mine them.

Cobalt-Rich Ferromanganese Crusts

Cobalt-rich ferromanganese crusts on Pacific seamounts have been known for at least 20 years. However, knowledge that the crusts could some day be an economically exploitable resource is recent, and technology for mining the crusts is no more advanced than technology for mining massive sulfides.

Despite lack of technology and detailed information about the resource, a consortium (consisting of Brown & Root of the United States, Preussag AG of West Germany, and Nippon Kokan of Japan) has expressed interest in mining cobalt-rich crusts in the U.S. EEZ surrounding the State of Hawaii and Johnston Island. Most observers expect that crusts, if mined at all, are likely to be mined before sulfides. With this in mind, Hawaii and the U.S. Department of the Interior have recently prepared an Environmental Impact Statement (EIS) in which the resource potential and potential environmental impacts of crust mining in the Hawaiian and Johnston Island EEZs are assessed.

In addition, a relatively detailed mining development scenario has been prepared as part of the *EIS*.⁶ The scenario describes and evaluates the various subsystems required to mine crusts. A number of approaches are possible for each subsystem, but the basic tasks are the same. Subsystems would be required to fragment, collect, and crush crust and probably to partially separate crust from substrate before conveying ore to the surface. The surface support vessel and subsystem for pumping ore

⁶U. S. Department of the Interior, Minerals Management Service, and State of Hawaii, Department of Planning and Economic Development, *Proposed Marine Mineral Lease Sale in the Hawaiian Archipelago and Johnston Island Exclusive Economic Zones* (Draft Environmental Impact Statement), app. A: "Mining Development Scenario Summary," January 1987.

to the surface probably would be similar to those already designed for mining manganese nodules.

Crusts form thin coatings on the surface of various types of nonvaluable substrates. A principal problem in designing a crust mining system will be to separate crust from substrate in order to minimize dilution of the ore. The thickness and continuity of the crust (which are often highly variable), the nature of its bonding to substrate, and the efficiency of the cutting device used will affect how much substrate is collected. The more substrate collected, the lower the ore grade and the greater the costs of transportation, processing, and waste disposal. The principal alternatives are to separate crust from unwanted substrate on the seabed (and thus avoid lifting substrate to the surface) or to separate crust and substrate on the mining vessel. Complete separation on the seabed of ore from

waste material would be preferable (if at all feasible), but costs to do so may be prohibitively high. It is more likely that only a small amount of the necessary separation will take place on the seabed and that most of the separation will take place on the mining vessel or onshore.

The mining system assumed in the EIS mining scenario employs a controllable, bottom-crawling tracked vehicle attached to a mining ship by a hydraulic lift system and electrical umbilical cord. However, before mining concepts can be significantly refined, more information will be required about the physical characteristics of the crusts. More data on the microtopography of crusts and substrate are an especially important requirement for the design of the key element of the mining system, a crust fragmenting device.

SOLUTION/BOREHOLE MINING

Solution or borehole mining has much in common with drilling for oil and gas; in fact, much of the technology for this mining method is borrowed from the oil and gas industry. Both terms refer to the mining of rock material from underground deposits by pumping water or a leaching solution down wells into contact with the deposit and removing the slurry or brine thus created. Because the mining process is accomplished through a drill hole, this method is applicable for recovering some types of ore without first removing overburden.

The Frasch process, used since 1960 to mine sulfur from salt dome deposits in the Gulf of Mexico, is the only current application of solution mining offshore (figure 5-13). From an offshore drilling platform, superheated water and compressed air are pumped into the sulfur deposit. The hot water melts the sulfur, and liquid sulfur, water, and air are forced to the surface for collection.⁷

Borehole mining has been considered for recovery of both onshore and offshore phosphates. The U.S. Bureau of Mines has tested a prototype borehole mining tool onshore. For mining, the tool is

lowered into a predrilled, steel-cased borehole to the ore. A rotating water jet on the tool disintegrates the phosphate matrix while a jet pump at the lower end of the tool pumps the resulting slurry to the surface. The slurry is then transported to a beneficiation plant by pipeline. The resulting cavity is backfilled with sand to prevent subsidence.

Results of economic feasibility studies of using the borehole mining technique onshore show that, where the thickness of the overburden is greater than 150 feet, borehole mining may be more economical than conventional surface mining systems.⁸ An elaborate platform would be required for mining offshore deposits, so capital costs are expected to be higher than for onshore deposits. Borehole mining of phosphate appears to be less destructive to the environment than conventional phosphate mining techniques and, if used offshore, would probably not require backfilling of cavities.

Solution mining also has been mentioned as a possible technique for mining offshore massive sulfides. Significant drawbacks include the application of chemical reagents capable of leaching these sul-

⁷1) F.Morse, "Sulfur," *Mineral Facts and Problems—1985 Edition*, Bulletin 67.5 (Washington, DC: U.S. Bureau of Mines, 1986), p. 785.

⁸J. A. Hrabik and D. J. Godesky, "Economic Evaluation of Borehole and Conventional Mining Systems in Phosphate Deposits," *Bureau of Mines Information Circular 8929*, 1983.

Figure 5-13.—Schematic of Solution Mining Technology (Frasch Process)

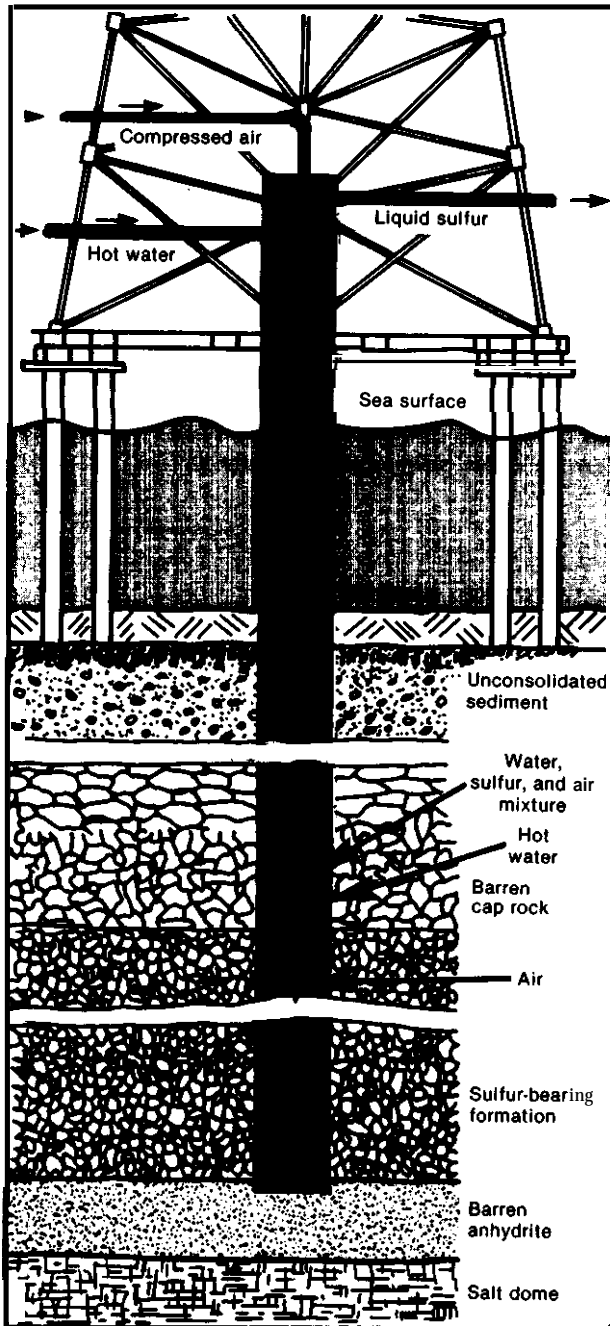

Solution mining of sulfur is currently done in the Gulf of Mexico. Borehole mining, which has been suggested for mining phosphorite, is similar, using high pressure water to disintegrate ore below overburden. The resulting slurry is then pumped to the surface.

SOURCES: *Encyclopedia Americana*, vol. 25 (Danbury, CT: Grolier, Inc., 1986), p. 868; J.W. Shelton, "Sulfur," *Mineral Facts and Problems*, 1980 ed. (Washington, DC: U.S. Bureau of Mines), p. 864.

vides, possible contamination of seawater by the chemical leach solutions required, and the probable necessity of fracturing impermeable deposits to allow the leach solution to percolate through the deposit. Solution/borehole technology is untested on marine hard-rock deposits.⁹

⁹Denton, "Review of Existing, Developing, and Required Technology."

OFFSHORE MINING TECHNOLOGIES

Unless concentrations of mineral deposits offshore are likely to be much higher than those on land, or unless the values of minerals increase, it is apparent that the mining industry will have less incentive to develop new technology than an industry like the petroleum industry. For example, the value of oil from a relatively small offshore field is likely to approach \$1 billion. In comparison, a reasonable target for an offshore placer gold deposit might have a value of \$100 million—an order of magnitude less.

Massive sulfides and other primary mineral deposits of the EEZ may some day present economic targets and offer incentives to development of mining technologies. These technologies are likely to depart significantly from dredging concepts and may be more closely related to solution mining, off-

shore petroleum recovery, or conventional techniques of hard rock mining.

Many of the technological advances made by the offshore petroleum industry would find applications in offshore mining, provided the offshore mineral deposits were rich enough to sustain the capital and operating costs of such developments. This technology transfer was demonstrated during the 1970s when several groups of leading international companies in the mining industry sponsored development work on methods for mining manganese nodules from depths of about 15,000 feet. These groups have delayed their plans for dredging nodules, primarily because prices for copper, nickel, cobalt, and manganese continue to be low, but also because the institutional regime imposed on the exploitation of the international oceanfloor is still evolving,

AT-SEA PROCESSING

Mineral processing involves separating raw material (ore) from worthless constituents and transforming it into intermediate or final mineral products. The number and type of steps involved in a particular process may vary considerably depending on the characteristics of the ore and the end product or products to be extracted. Mineral processing encompasses a wide range of techniques from relatively straightforward mechanical operations (beneficiation) to complex chemical procedures. Processing may be needed for one or more of the following tasks:

1. To **control particle size**: This step may be undertaken either to make the material more convenient to handle for subsequent processing or, as in the case of sized aggregate, to make a final product suitable for sale.
2. To **expose or release constituents for further processing**: Exposure and liberation are achieved by size reduction. For cases in which minerals must be separated by physical processes, an adequate amount of freeing of the different minerals from each other is a prerequisite.
3. To **control composition**: Constituents that would make ore difficult to process chemically

or would result in an inadequate final product must be eliminated or partially eliminated (e. g., chromite must be removed from ilmenite ore in order to meet specifications for pigment). Often, an important need is to eliminate the bulk of the waste minerals from an ore to produce a concentrate (beneficiation).¹⁰

Processing of marine minerals may take place either on land or at sea or partly on both land and sea, depending on economic and technological considerations. Where processing is to be done wholly or partly at sea, it is integrated closely with the mining operation. However, since almost no mining has taken place to date in the EEZ, offshore processing experience is limited. Processing technology for minerals found on land has developed over many centuries and, in contrast to requirements for offshore processing, has been designed to operate on stable, motionless foundations and, with few exceptions, to use fresh water.

It is usually not desirable to do all processing of marine minerals offshore. Final recovery may be done onboard in the case of precious minerals, such

¹⁰E.G. Kelly and D.J. Spottiswood, *Introduction to Mineral Processing* (New York, NY: John Wiley & Sons, 1982), pp. 5-6.

as gold, platinum, and diamonds, but all other minerals would probably be taken ashore as bulk concentrates to be further processed. Trade-offs must be considered in evaluating whether to partially process some minerals offshore. First, the cost of transporting unbeneficiated ore to shore must be weighed against the added costs and capital expenses of putting a beneficiation plant offshore. Transportation to shore of a smaller amount of high grade concentrate may be more economical than transporting a larger amount of lower grade ore to shore for beneficiation and subsequent processing. (This is also a standard problem on land when evaluating trade-offs between, for example, building a smelter or investing in transportation to an existing smelter.) Second, it is generally thought to be easier and more economical to discharge tailings (waste materials) at sea than on land, but tailings discharge may result in unacceptable environmental impacts. Third, while seawater is an unlimited source of water for use in many phases of processing, its higher salinity could make processing more difficult and concentrates could require additional washing with fresh water.

Important considerations in evaluating whether to process minerals offshore may include the cost of space aboard mining vessels and the sensitivity of some processing steps to vessel motion. Space is an important factor in the economics of a project. Since larger platforms cost more, engineers must consider the trade-offs between using a hull or platform large and stable enough to contain additional processing equipment, power, fuel, storage space, and personnel and transporting unbeneficiated ore to shore. Although little experience is available, vessel motion may make some processing steps difficult or impossible without motion compensation equipment and may significantly reduce the efficiency of recovering some minerals. Power requirements are also of major concern because all power must be generated onboard, thus requiring both additional space and costs. Personnel safety, the availability of docking facilities, distance to refineries, and production rates may also influence processing decisions.¹¹

¹¹M.J. Cruickshank, 'Marine Sand and Gravel Mining and Processing Technologies, *Marine Mining*, in press.

Some basic development options include limiting the motion of the platform (e. g., by using a semi-submersible); isolating the processing equipment from platform motion (e. g., by mounting it on gimbals); redesigning the processing equipment to make it more efficient at sea; or simply accepting lower grade concentrate by using existing and, hence, less costly equipment. In the case of mineral processing, an initial priority probably would be to test existing processing equipment at sea to obtain operating experience.

The costs and efficiency of operating a processing plant at sea are highly uncertain. For example, motion compensation of specific sections of the onboard plant or of major portions of the vessel is expensive. For most minerals, further development of technology will be needed to optimize offshore mineral processing equipment and procedures. In general, one would probably attempt to perform the easy and relatively inexpensive processing steps offshore, such as size separation and rough gravity concentration, to reduce the bulk of material to be transported, then complete the processing on land.

There are three broad categories of mineral processing technology:

1. technology for unconsolidated deposits of chemically inert minerals,
2. technology for unconsolidated or semi-consolidated deposits of chemically active minerals, and
3. technology for consolidated deposits of minerals requiring crushing and size reduction.

Processing Unconsolidated Deposits of Chemically Inert Minerals

Chemically inert minerals include gold; platinum; tin oxide (cassiterite); titanium oxides (ilmenite, rutile, and leucosene); zircon; monazite; diamonds; and a few others. These occur in nature as mineral grains in placers (see ch. 2) and are often found mixed with clay, sand, and/or gravel particles of various sizes. Since these minerals are generally heavier than the silicate and other minerals with which they may be mixed, the use of mechanical gravity separation methods is important in processing (figure 5-14). However, the initial step

Figure 5-14.—Technologies for Processing Placer Mineral Ores

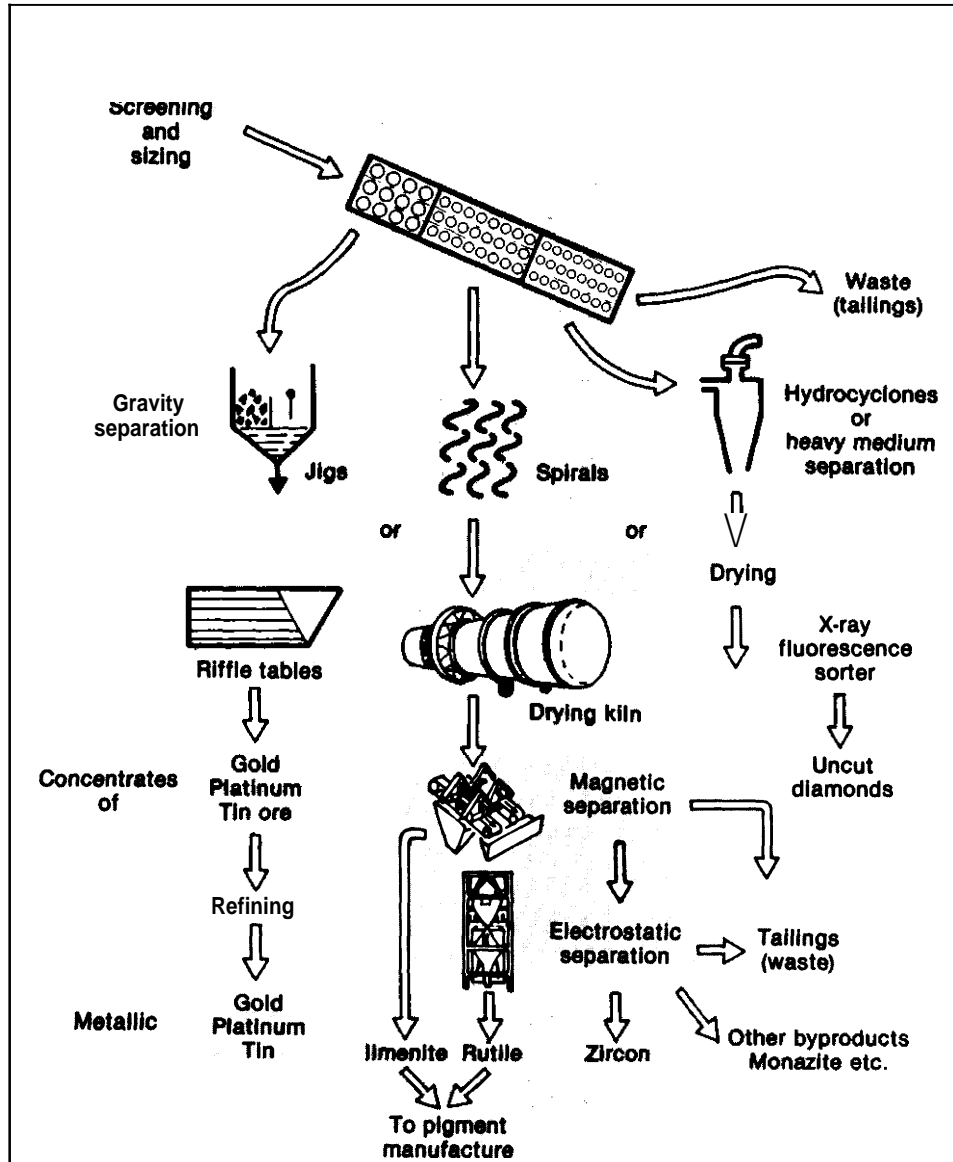

Offshore screening, sizing, and gravity separation may be adopted to reduce the amount of material that must be brought to shore. Drying and magnetic and electrostatic separation steps will most likely take place ashore.

SOURCE Off Ice of Technology Assessment, 1987.

in processing ores containing mineral grains of various sizes is usually size separation.

Size separation may be needed to control the size of material fed to other equipment in the processing stream, to reduce the volume of ore to be concentrated to a minimum without losing the target mineral(s), and/or to produce a product of equal

size particles. Separation is accomplished by use of various types of screens and classifiers. Screens—uniformly perforated (and sometimes vibrating) surfaces that allow only particles smaller than the aperture size to pass—are used for coarser materials.¹² The size of screen holes varies with the ma-

¹²Ibid

terial, production capacity of the dredge, and other factors. For example, sand and gravel alone may constitute the valuable mineral fraction. To be sold as commercial aggregate, sand and gravel are generally screened to remove the undesirable very fine and very coarse fractions.

One type of size separation device in common use on dredges is the trommel. A trommel is simply a rotating cylindrical screen, large enough and strong enough to withstand the shock and abrasion of thousands of tons of sand and gravel sliding and tumbling through it each hour. If the material is mined by a bucket dredge, the material may be disaggregated by powerful water jets while it slides downward through a rotating trommel. If the material is mined by a suction dredge, it may already be disaggregated but may need dewatering before screening. In either case gravity plays an important role, since the material must first be elevated in order to slide downward through the screens.

Classifiers are used for separating particles smaller than screens can handle. Classifiers separate particles according to their settling rate in a fluid. One type in common use is the hydrocyclone. In this type of classifier, a mixture of ore and water is pumped under pressure into an enclosed circular chamber, generating a centrifugal force. Separation takes place as the heavier materials fall and are discharged from the bottom while the lighter particles flow out the top. Hydrocyclones are mechanically simple, require little space, and are inexpensive. Most offshore tin, diamond, and gold mining operations separate material by screening and/or cycloning as a first step in mineral recovery.

Following size separation, gravity separation techniques are used to concentrate most of the minerals in this category. By gravity, the valuable heavier minerals are separated from the lighter, less valuable or worthless constituents of the ore. Processing by gravity concentration takes advantage of the differences in density among materials. Several different technologies have been developed, including jigs, spirals, sluices, cones, and shaking tables.¹³

Jigging is the action of sorting heavier particles in a pulsating water column. Using either air pressure or a piston, the pulsations are imparted to an

introduced ore-water slurry. This action causes the heavier minerals to sink to the bottom, where they are drawn off. Lighter particles are entrained in the cross-flow and discharged as waste. Secondary or tertiary jigs may be used for further concentration. Several different types of jig have been developed, including the circular jig, which has been used extensively on offshore tin dredges in Southeast Asia. Jigs also have been used successfully offshore to process alluvial gold and diamonds. For example, they have proved effective in eliminating 85 to 90 percent of the waste material from tin ore (cassiterite) in Indonesia and from gold ore in tests near Nome, Alaska.

Some jigs may be sensitive to the rolling and pitching motion of a mining dredge at sea, depending in part on the severity of the motion and in part on their location aboard the dredge (usually high above the deck to use gravity to advantage). This has not been a major problem on Indonesian offshore bucket dredges, although sea conditions there are not as rough as in other parts of the world. Design of dredges for less rolling motion and for reduced sensitivity to wind forces (e. g., by placing the processing plant and machinery below the waterline) would alleviate this problem. Lower profile dredges could be designed without much difficulty, provided economic incentives existed to do so.

A simple gravity device for concentrating some placer minerals onshore is a riffle box for sluicing material. Although neither well understood nor very efficient, sluicing is the one of the oldest types of processing technology for concentrating alluvial gold or tin. In addition to their simplicity, sluices are rugged, passive, and inexpensive. Although sluices have not been used offshore, they might be utilized to beneficiate ore of low-value heavy minerals such as ilmenite or chromite.

Many other types of gravity separation devices are used onshore to separate inert heavy minerals from mixtures of ore and water. The most common are spirals (e. g., Humphrey's spirals) and cyclones. Spirals (figure 5-15) are used extensively to concentrate ilmenite, rutile, zircon, monazite, chromite, and magnetite from silicate sands of dunes and ancient shorelines. The effectiveness of spirals mounted on platforms subject to wave motions is not well known, but spirals have been used

¹³Ibid

Figure 5-15.—Operating Principles of Three Placer Mineral Separation Techniques

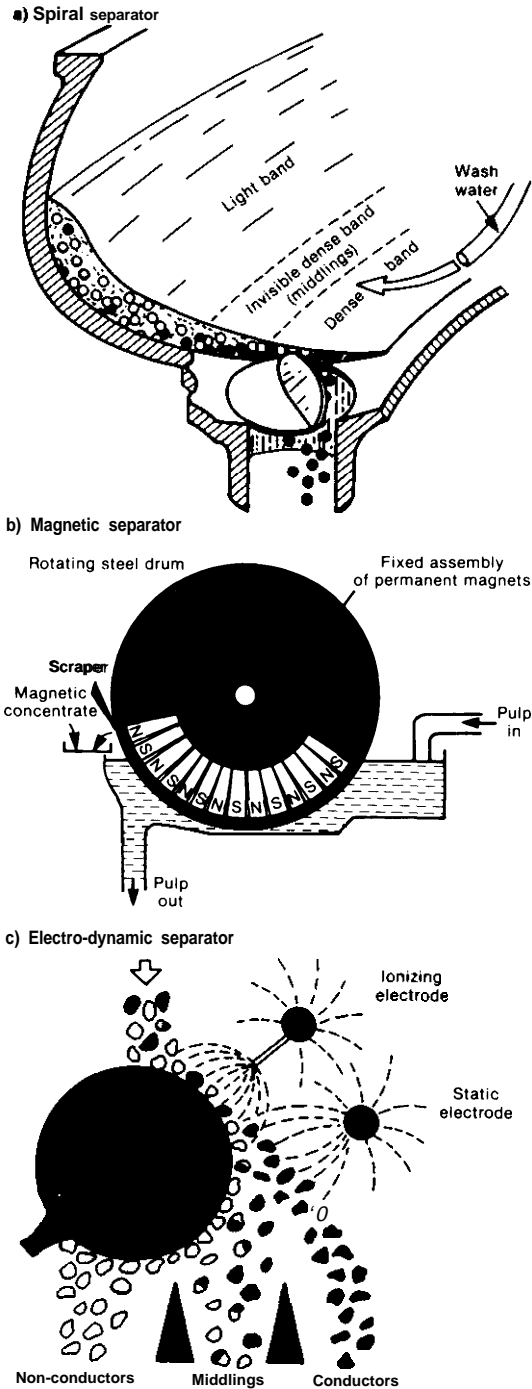

Gravity separation using spirals may be adapted for offshore use in some circumstances. Magnetic and electro-dynamic separation will most likely be done on land.

SOURCE: E G KeHey and D J Spottiswood, *Introduction to Mineral Processing* (New York John Wiley & Sons, 1982).

successfully for sample concentration on board ship. In operation, an ore-water slurry is introduced at the top of the spiral. As the slurry spirals downward, the lighter minerals are thrown to the outside by centrifugal force, while the heavy minerals concentrate along the inner part of the spiral. The heavy minerals are split from the slurry stream and saved. Spirals have lower rates of throughput than jigs. Moreover, more space would be required to process an equal volume of minerals, and spirals are unsuited for separating particles larger than about one-quarter inch,

Another form of heavy mineral processing that may have applications offshore is heavy media separation. This gravity separation technique uses a dense material in liquid suspension (the heavy medium) to separate heavy minerals from lighter materials. The "heavies" sink to the bottom of the heavy medium, while lighter materials, such as silicates, float away. The heavy liquid is then recirculated. This technique has been used effectively offshore to recover diamonds. However, it is expensive and its use may contaminate seawater.

Initial "wet" concentration at sea results in a primary concentrate. Much of the technology for size classification and gravity separation of minerals appears to be adaptable for use at sea for making primary concentrates without major technological problems. For further preparation for sale, concentrates of heavy minerals are usually dried and separated on shore. For example, ilmenite and magnetite are considered impurities in tin ore and must be eliminated. Producing heavy mineral concentrates for final sale may also involve further gravity separation, drying in kilns, and/or elaborate magnetic and electrostatic separation operations.

Magnetic separation is possible for those minerals with magnetic properties (figure 15-5). For example, magnetite may be separated from other heavy minerals using a low-intensity magnetic separation technique. Ilmenite or other less strongly magnetic minerals may be separated from nonmagnetic minerals using a high-intensity technique. Separation at sea of strongly magnetic minerals is possible, but separation of minerals with small differences in magnetic susceptibility may have to be done on land. Magnetite has the highest magnetic susceptibility. In decreasing order of susceptibility are ilmenite and chromite; epidote and xenotime; apatite, monazite, and hematite; and staurolite.

Conducting minerals may be separated from nonconductors using electrostatic separation. Only a few minerals are concentrated using this method, but electrostatic separation is used very successfully to separate heavy mineral beach sands, such as rutile and ilmenite from zircon and monazite.¹⁴ Figure 5-15 illustrates how conducting and nonconducting minerals and "middlings" are split from each other using an electro-dynamic separator. During processing, the feed particles acquire an electrical charge from an ionizing electrode. Conducting minerals lose their charge to the grounded rotor and are thrown from the rotor's surface. A non-ionizing electrode is then used to attract conducting minerals further away from the rotor. Nonconductors do not lose their charge as rapidly and so adhere to the grounded rotor until they do lose their charge or are brushed off. Middlings may be run through the electrostatic separator again.¹⁵ Electrostatic separation is usually combined with gravity and magnetic separation methods when separating minerals from each other.

Many of these technologies require adjustments, depending in part on the volume and grade of ore passing through the plant and on the ratio of input ore to output concentrate or final product. The ratios of valuable mineral to ore mined are shown in table 5-3 for some typical heavy minerals. The amount of primary concentrate produced by jigs on a dredge mining 30,000 cubic yards of gold ore per day would be on the order of a few tons (depending on the other heavy minerals present); initial processing of 30,000 cubic yards per day of ilmenite ore would yield a few hundred tons of primary concentrate.

The amount of machinery, space, and power needed for producing a final concentrate or product varies widely for different minerals. Final separation and recovery of ilmenite, rutile, zircon, and

monazite require elaborate plants that occupy large spaces and consume large amounts of energy. These heavy minerals are first dried in long kilns, then passed through batteries of magnetic and electrostatic separators. Experience using these technologies is mostly on land, and there do not appear to be any economic advantages to undertaking final separation and recovery of these minerals offshore. Conversely, technologies for final recovery of diamonds, gold, and tin occupy little space and consume little power. Some techniques (e. g., shaking tables) require flat, level platforms. Final recovery of gold by amalgamation with mercury can be easily done at sea if the mercury is safely contained. Final separation of diamonds from concentrates is done using X-rays.

Processing Unconsolidated or Semi-Consolidated Deposits of Chemically Active Minerals

Examples of unconsolidated or semi-consolidated deposits of chemically active minerals include minerals found in such deposits as the Red Sea brines and sulfide-bearing sediments on the Outer Continental Shelf. In general, the minerals of economic interest in ore deposits of this type are complex sulfides of base metals such as copper and zinc, and minor quantities of precious metals (mainly silver).

This type of mineral is generally concentrated on land using flotation technology (figure 5-16). Flotation concentration is based on the surface chemistry of mineral particles in solution. Methods vary, but all employ chemical reagents that interact with finely crushed sulfide particles to make them selectively hydrophobic. The solution is aerated, and the hydrophobic minerals adhere to the air bubbles and float to the surface (other mineral particles sink to the bottom). A froth containing the floated minerals is formed at the surface of the solution and is drawn off.¹⁶ Flotation concentrates are collected on filters and dried prior to further pyrometallurgical processing (e. g., smelting) to separate individual metals.

Experimental flotation of metalliferous muds at a pilot-scale plant in the Red Sea is the only experience using this process offshore. Since wind,

¹⁴Ibid.

¹⁵Ibid.

Table 5-3.—Ratio of Valuable Mineral to Ore

	In ore mined	In primary concentrate
Diamonds	1:5,000,000	1:1,000
Gold, platinum	1:2,000,000	1:1,000
Tin	1:1,000	1:100
Ilmenite, etc.	1:100	1:10

SOURCE Office of Technology Assessment, 1987.

¹⁶Ibid.

Figure 5-16.—Technologies for Processing Offshore Mineral Ores

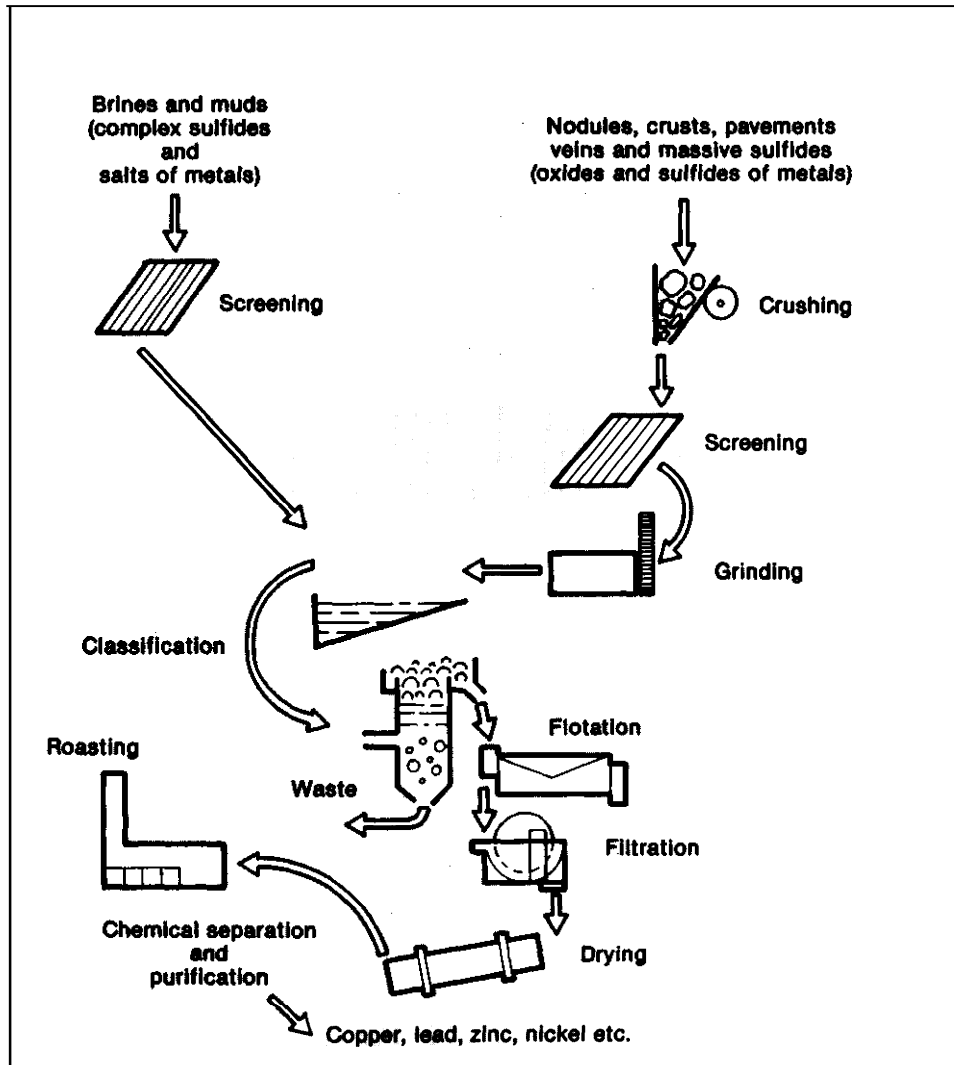

Consolidated deposits of nodules, crusts, and massive sulfides require crushing and grinding in addition to the screening required for brines and muds. Flotation is the primary technique for separating oxides and sulfides of metals from waste material. These processes have not yet been adapted for use offshore.

SOURCE: Office of Technology Assessment, 1987

wave, and current conditions in the Red Sea are not as severe as in the open ocean, these tests are not conclusive regarding the sensitivity of flotation methods to ship motion. Disposal of flotation reagents at sea may be a problem in some cases and should be further investigated.

Processing Consolidated and Complex Mineral Ores

Mineral deposits in this category include nodules, crusts, veins, pavements, and massive deposits, as of metalliferous sulfides or oxides. Process-

ing of these minerals is likely to require crushing or grinding to reduce particle size, followed by chemical separation methods. In some cases (i. e., for gold veins) fine grinding may liberate minerals which then may be recovered using gravity separation alone. However, in most cases some flotation and/or other chemical processing is likely to be required. The Bureau of Mines has experimented with column flotation techniques for separation of cobalt-rich manganese crust from substrate. Crust

separated in this manner, however, cannot simply be concentrated by inexpensive mineral processing techniques. Most of these processes have not been adapted for use at sea. Crushing and grinding circuits could be mounted on floating platforms or on the seafloor, but unless the economic incentive to mine this type of seafloor deposit improves, these techniques will not likely be used offshore in the near future. The same comment applies to flotation and other chemical processing technologies.

OFFSHORE MINING SCENARIOS

To illustrate the feasibility of offshore mining, OTA constructed five scenarios, each depicting a prospective mining operation in an area where elevated concentrations of potentially valuable minerals are known to occur. The scenarios illustrate factors affecting the feasibility of offshore mining, including the physical and environmental conditions that may be encountered offshore, the capabilities of the available mining and processing technologies, and estimated costs to mine and process offshore minerals. The scenarios selected include mining of:

- titanium-rich sands off the Georgia coast,
- chromite sands off the Oregon coast,
- gold off the Alaska coast near Nome,
- phosphorite off the Georgia coast near Tybee Island, and
- phosphorite in Onslow Bay off the North Carolina coast.

These shallow-water mineral deposits were selected because they are judged to be potentially mineable in the near term, unlike, for example, deposits of cobalt-rich ferromanganese crusts or massive sulfides, both of which would require considerable engineering research and development.

For each scenario, the ocean environments are considered to be acceptable for dredging operations, dredging technologies are judged to be available with little modification, and existing processing technologies are considered adaptable for shipboard use, although some development will be needed. The greatest uncertainties arise from lack of data on the nature of the placer deposits (except for Nome, reserves have not been proven by drilling)

and from the lack of operating experience under conditions encountered in the U.S. EEZ (i. e., waves and long-period swells).

OTA did not attempt detailed engineering and cost analyses. Too little information is currently available to accurately assess the profitability of offshore mining. For example, the grade of ore may vary considerably throughout a deposit, but little information about grade variability has been compiled yet at any site. Estimates of mining and processing costs can vary considerably depending on the amount of information on which they are based. Given that estimates cannot now be based on detailed information, OTA has attempted simply to estimate the range within which costs are most likely to fall. Rough estimates do not satisfy the need for detailed feasibility studies based on comprehensive data; however, they do provide criteria with which to judge if recovery of large quantities of high grade, valuable minerals on the seabed is likely to be profitable or at least competitive with land-based sources of minerals.

Similar scenarios for titanium, chromite, and gold placers also have been developed recently by the U.S. Bureau of Mines.¹⁷ The scenarios are not directly comparable, but, after allowing for different assumptions and uncertainty, the general conclusions reached are roughly the same. Tables 5-9, 5-10, and 5-11 at the end of the chapter compare OTA and Bureau of Mines scenarios.

¹⁷ *AD Economic Reconnaissance of Selected Heavy Mineral Placer Deposits in the U.S. Exclusive Economic Zone*, Open File Report 4-87 (Washington, D. C.: U.S. Bureau of Mines, January 1987).

Offshore Titaniferous Sands Mining Scenario

Location.—Concentrations of titaniferous sands are known to occur on the seabed adjacent to the coast of Georgia (figure 5-17). These sands constitute a resource of titanium oxide minerals (primarily ilmenite, but also lesser amounts of rutile and leucoxene, (figure 5-18)) and associated light heavy minerals. However, little detailed exploration has been done in the area, so the extent and grade of the resource is not precisely known.

Two mineral companies that mine onshore titaniferous sands in nearby northeastern Florida have expressed interest in the area. In fact, in 1986, the Minerals Management Service issued geological and geophysical exploration permits to Associated Minerals U. S. A., Ltd., and E.I. du Pont de Nemours & Co. The companies have undertaken shallow coring, sub-bottom profiling, and radiometric surveys in the area. The area of interest extends from Tybee Island in the north to Jekyll Island in the south, a distance of about 85 nautical miles, and from State waters to about 30 nautical miles offshore. The proximity of onshore titanium mineral processing facilities in northeastern Florida is a particular reason this scenario site was selected over other potential sites on the Atlantic Ocean continental shelf.

Operational and Geological Characteristics.—Within this area, a typical mine site was selected approximately 30 nautical miles offshore. Water depths at this site average 100 feet. Northeasterly winds tend to prevail from October to March. The site is in the path of occasional “northeasters” and hurricanes, but wind, wave, tide, and current conditions are otherwise moderate. Wave heights of 6 feet are common during winter months, but waves of 1 to 4 feet are more typical the rest of the year. Infrequent severe storms may produce waves in excess of 20 feet, typically from the southeast or northeast. It is assumed that operations can be conducted 300 days per year.

The geological features of the site were identified primarily by sub-bottom profiling and include buried stream channels and submerged shorelines. A similar ancient shoreline target onshore in northeastern Florida would be 12 miles long, 1 mile wide, and 20 feet thick. Little is known about any over-

burden at this time, so it is assumed that the deposit, like similar deposits onshore at Trail Ridge, Florida, consists of unconsolidated heavy mineral sands without significant overlying sediments.

The average concentration of total heavy minerals in the ore is assumed to be between 5 and 15 percent by weight, about half of which are economic heavy minerals. This range includes the average grade of the heavy mineral concentrations detected in the few samples from the site that have been analyzed to date.

Mining Technology.—The most appropriate technology for mining titaniferous minerals at the selected site is considered to be a trailing suction hopper dredge. This dredge is capable of operating in the open ocean at the mining site and of shuttling to and from its shore base during the normal seas expected in this region. Trailing suction hopper dredges have been widely used for sand and gravel mining and for removing unconsolidated material from harbors and channels. It is assumed that the titaniferous sand is at most only mildly compacted. The unconsolidated mineral sands are sucked up the drag arms, which can adjust to vessel heave and pitch to maintain the suction head on the seabed. A booster pump is installed in the suction line, enabling the dredge to reach minerals at the assumed bottom of the mineralized zone, about 120 feet below sea level. If cutting force is needed to loosen the compacted sand and clay, high-pressure water jets and cutting teeth can be added to the suction head. A dredge with a hopper capacity of 5,000 cubic yards is used. The dredge is assumed to be of U.S. registry, built and operated according to Coast Guard regulations, and more expensive than a similar dredge built abroad. All equipment is assumed to be purchased new at 1987 market prices.

At-Sea Processing.—The dredge is outfitted with a wet primary concentration plant capable of producing 450,000 tons per year of heavy mineral concentrate for delivery to a dry mill on shore. The efficiency of economic heavy mineral recovery is assumed to be 70 percent for the wet plant and 87.5 percent for the dry plant. The final product concentrate supplies the raw material for a pigment plant. It is assumed that no major technical problems are encountered in designing the primary con-

Figure 5-17.—Offshore Titaniferous Mineral Province, Southeast United States

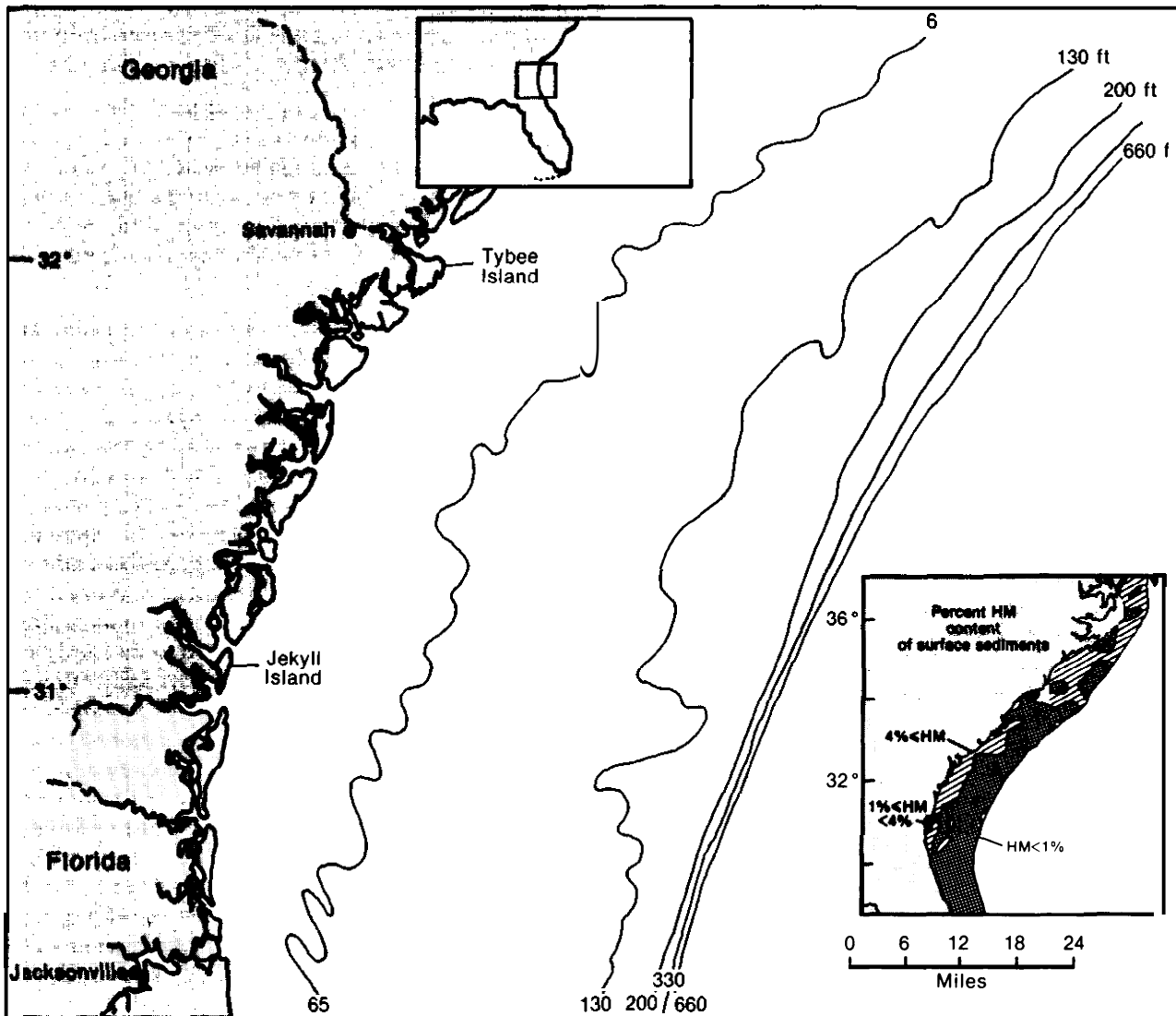

URCES: Office of Technology Assessment, 1987; A.E.Grosz, J.C. Hathaway, and E.C.Escowitz, "Placer Deposits of Heavy Minerals in Atlantic Continental Shelf Sediments," Proceedings of the 18th Annual Offshore Technology Conference, Houston, TX, May 5-8, 1986.

centration plant to compensate for operation on a moving vessel, and that the processing subsystems do not require significant and/or expensive development work. The onboard processing plant produces the primary concentrate using conventional particle size separation and gravity separation equipment. Seawater is used in the gravity separation process. Production of 450,000 short tons per year of primary concentrate implies mining rates between 3.2 million and 9.5 million short tons of ore per year, corresponding to ore grades of 15

and 5 percent. Larger pumps consuming more power would be required to mine 5 percent ore at the same rate as 15 percent ore.

Mining and At-Sea Processing Cycle.—The mining and at-sea processing cycle consists of five steps:

1. The dredge steams to the mining site,
2. it dredges material from the seabed,
3. it preconcentrates the ore and fills up the hopper,

Figure 5-18.—Values of TiO₂ Content of Common Titanium Mineral Concentrates and Intermediates

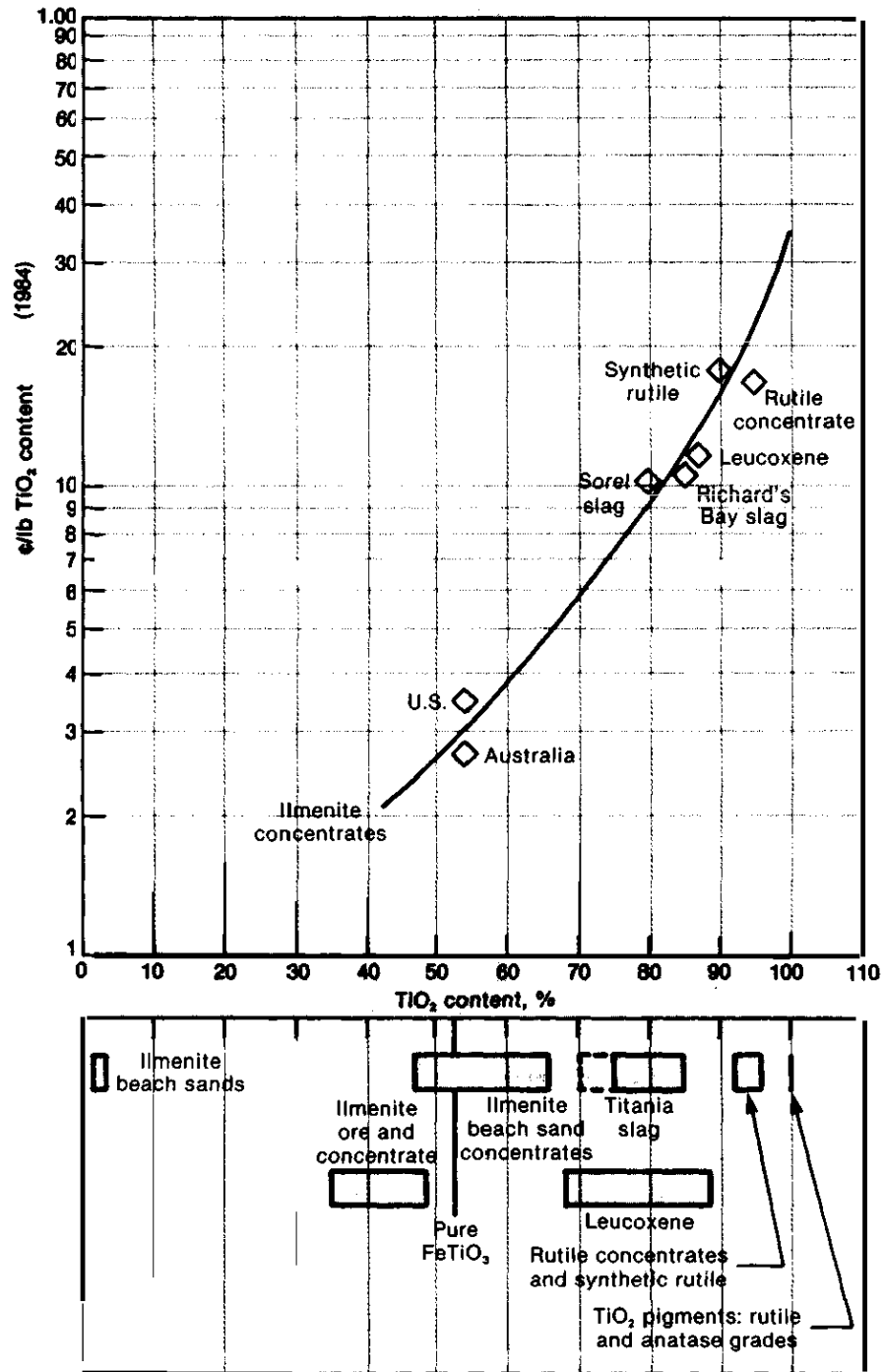

SOURCE: W.W. Harvey and F.C. Brown, "Offshore Titanium Heavy Mineral Placers: Processing and Related Considerations," contractor report prepared for the Office of Technology Assessment, November 1986.

4. steams to the shore base, and
5. it discharges the preconcentrate from the hopper.

Each of these cycles takes 4 days: 3 days for dredging and processing and 1 day for transit and offloading. Seventy-five such cycles per year can be made using a trailing suction hopper dredge with a 5,000 -cubic-yard hopper capacity. This allows 60 days per year for drydocking, maintenance, and downtime due to weather or other contingencies. The average distance from offshore deposits to the shore-side discharge point is estimated to be 100 miles.

The requirement to stop dredging and return to port could be eliminated by loading shuttle barges instead of filling the dredge hoppers. Other alternatives to the scenario probably would be evaluated by prospective miners who, for example, might process to a higher concentrate grade offshore.

Capital and Operating Costs.—Total capital requirements are estimated to range from \$55 million to \$86 million, depending on average ore grade (ranging from 15 to 5 percent respectively). Capital costs include costs of the dredge, onboard wet mill, onshore unloading installation, dry mill, and working capital (table 5-4). Capital costs for both the dredge and onboard wet mill decrease as the ore grade increases because less mining (pumping) capacity is required. Total operating costs are higher for lower grade ore because more ore must be mined by a larger dredge to produce the same amount of concentrate. Annual costs to operate the dredge, wet mill, and dry mill, and for general and

administrative expenses and depreciation are estimated to be from \$25 million to \$37 million, depending on the heavy mineral content (15 to 5 percent). Given these estimates for capital and operating costs, breakeven revenue requirements have been calculated to range from \$170 to \$250 per ton of marketable product.

Given the risks inherent in developing an offshore deposit, the developers would expect higher returns than for a conventional land-based mineral sands operation and require a more rapid payback on investment. For example, under the 1986 tax law, a 3-year payback would require revenues of between \$420 and \$280 per ton of product for ore grades ranging from 5 to 15 percent. Since the current U.S. east coast price of ilmenite concentrate is \$45 to \$50 per short ton, it is clear that the deposit would require appreciable concentrations of other valuable minerals (e. g., rutile, zircon, and/or monazite with values ranging from \$180 to \$500 per ton) to be profitable.

Offshore Chromite Sands Mining Scenario

Location. —Concentrations of heavy mineral sands containing primarily chromite, lesser amounts of ilmenite, rutile, and zircon, and traces of gold and other minerals occur in surface and near-surface deposits on the continental shelf off southern Oregon (figure 5-19). Many reconnaissance surveys conducted by academic researchers have been completed in the area, but no detailed mineral exploration has taken place. The largest heavy mineral sand area appears to extend westward from the mouth of the Rogue River and northward toward Cape Blanco. A second area of chromite-rich black sands is located seaward of the mouth of the Sixes River. Additional small deposits occur on the continental shelf and on uplifted marine terraces between Coos Bay and Bandon. The Rogue River deposits are approximately 75 miles south of Coos Bay, the nearest deep-water industrial port, and 100 miles north of the port of Eureka, California.

No State or Federal exploration permits have been issued in the area to the private sector. However, one company, Oregon Coastal Services, has expressed interest in obtaining a permit to explore for minerals in State waters.

Table 5-4.—Offshore Titaniferous Sands Mining Scenario: Capital and Operating Cost Estimates

	Ore grade		
	50/0	10 %0	15%0
Capital costs (million \$):			
Dredge	\$40	\$36	\$32
Offshore processing	34	18	14
Onshore processing	4	4	4
Working capital	8	6	5
Total capital costs	\$86	\$64	\$55
Annual operating costs (million \$):			
Dredge and offshore processing	\$17	\$14	\$12
Onshore processing	2	2	2
General and administrative	2	1	1
Depreciation expense	16	11	10
Total operating costs	\$37	\$28	\$25

SOURCE: Office of Technology Assessment, 1987.

Figure 5-19.—Offshore Chromite Sands, Oregon Continental Shelf

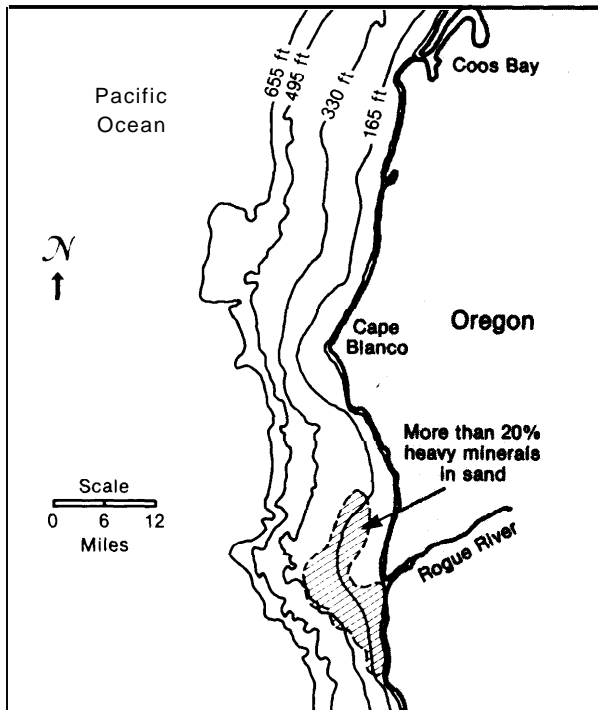

SOURCE: Adapted from T Parmenter and R Bailey, *The Oregon Ocean Book* (Salem, OR: Oregon Department of Land Conservation and Development, 1985), p. 21

Operational and Geological Characteristics.—The site selected for this scenario lies seaward of the Rogue River, from 2 to 4 miles offshore. Water depths in the vicinity of the mine site are between 150 and 300 feet. The main deposit is assumed to be roughly 22 miles long by 6 miles wide and straddles the boundary between State and Federal waters.

Summer waves, generally from the northwest, are driven by strong onshore winds and range in height from 2 to 10 feet. In winter, waves are characteristically from the west or southwest and average 3 to 20 feet. The most severe storms, which occur from November through March, may occasionally produce wave heights in excess of 60 feet. The severity of the wave regime off the coast of Oregon has been compared to that of the North Sea. In addition to weather, a seasonal factor that may affect mining activity is prior use of the area by sea lions as a breeding ground and by salmon fishermen for sport and commercial fishing.

Coastal terrace deposits between Coos Bay and Bandon, north of the scenario site, are likely analogs of potential continental shelf placers (see ch. 2). Most samples taken from these deposits have contained from 6 percent to as much as 13 percent chromite, usually concentrated in the bottom 3 to 15 feet of the stratigraphic section, although samples containing as much as 25 percent chromite have been taken in some places.¹⁸

This scenario assumes that offshore placers contain similar grades of chromite and that the average grade is closer to 6 percent. Magnetic anomaly studies associated with surface concentrations in the scenario area suggest that the potential placer bodies lie beneath a sediment overburden that ranges from less than 3 feet to more than 100 feet thick. The ore body thickness at the mining site is assumed to be less than 25 feet.

Mining Technology.—This scenario assumes that the chromite placers are largely unconsolidated deposits and that a trailing suction hopper dredge similar to the one used in the titanium sands scenario is applicable for mining. The dredge is equipped with twin 3,400-horsepower suction pumps, giving it a greater suction capacity than the dredge used to mine titanium sands.

Dredging in rough seas at depths ranging from 150 to 300 feet will require a special design; however, it is assumed this need will not present greater technical problems or costs than, for example, building dredges or pipe-laying vessels for the North Sea. The dredge is similar in its other characteristics to the hopper dredge described in the titanium sands scenario.

At-Sea Processing.—High volumes of ore can be brought to the surface at relatively low cost, but transporting the material to shore is costly. Therefore, there is an incentive to enrich the ore as much as economically and technically feasible prior to transporting it to shore. This scenario assumes primary beneficiation at sea by a simple, low-cost process of screening and gravity separation. The system might incorporate devices such as cones, jigs, spirals, or a very large sluice box. As in the titanium

¹⁸LaVerne D. Kilm, College of Oceanography, Oregon State University, OTA Workshop on Pacific Minerals, Newport, Oregon, Nov. 20, 1986.

sand mining scenario, the effect of vessel motion on these devices needs to be evaluated. It is assumed that 30 to 50 percent of the dredged ore will be kept on the vessel and that the tailings will be continuously discharged by pipe back to the seafloor.

There are no at-sea processing plants of this type in operation. Additional investigation is needed to evaluate the feasibility and to determine the capital and operating costs of this system, but it is assumed that the development engineering required will not entail major costs.

Mining and At-Sea Processing Cycle.—Increased suction capacity plus a shorter distance to dockside and less elaborate processing at sea enable the dredge to deliver 5,000 tons of enriched ore to shore per day (rather than every third day as in the case of the titanium sands scenario). Under normal operating conditions, the dredge is assumed to take about 3 hours to fill to capacity. The vessel then steams an average distance of 75 miles for offloading at a shore facility. Transit time is estimated to average about 8 hours, offloading time less than 5 hours; hence, the vessel would be able to make one round trip per day. At dockside the dredge would be offloaded using either a dry scraper or its own pumps. Pumped transfer decreases offloading time. If this method is used, the ore is pumped into a dewatering bin and from there transported by conveyor belt to a stockpile. It is assumed that the mining and processing system can be designed so that mining and processing at sea can take place 300 days a year. This would leave 65 days

for downtime due to bad weather or sea conditions, for drydocking and maintenance, and for other unforeseen events. Under these assumptions, 1.5 million tons of chromite-rich concentrate are delivered yearly to the offloading plant onshore.

Capital and Operating Costs.—Capital and operating costs (table 5-5) were estimated for mining, at-sea processing, transportation, and offloading at a shoreside facility, but not for subsequent processing on land. Capital costs amount to approximately \$57 million for an operation that uses all new equipment developed for the project and built in the United States. These include a dredge (\$40 million), shipboard primary beneficiation plant (\$5 million), shoreside facility (about \$5 million), and design, engineering, and management (\$7 million). Annual operating costs are estimated to be approximately \$20 million; this figure includes costs to operate the dredge and shore facility and general and administrative expenses.

Based on the above figures and assumptions, the cost of delivering enriched chromite sand to a shore-based facility was calculated. In terms of dollars per ton of beneficiated ore, the range is between \$12.50 and \$22. The lower cost assumes the use of a secondhand dredge. The higher cost includes a 20 percent internal rate of return which is assumed to be a realistic goal in view of the uncertainties (especially operating time) that surround the project. (If the yearly operating time were reduced to 150 days, the costs of delivering concentrates would double to between \$25 and \$44 per ton).

Table 5-5.—Offshore Chromite Sands Mining Scenario: Capital and Operating Cost Estimates

Millions of dollars		
<i>Capital Costs:</i>		
Suction hopper dredge		\$40.0
Shipboard primary beneficiation plant		5.0
Shoreside facility		5.0
Engineering procurement and management (15%)		7.5
Total		\$57.5
	New equipment (excluding profit and risk)	Used equipment (excluding profit and risk)
<i>Annual operating costs:</i>		
Dredge	\$17	\$15
Shore facility	2	2
General and administrative	3	2
Annual total	\$22	\$19

SOURCE: Office of Technology Assessment, 1987.

Box 5-A.—Sand and Gravel Mining

Mining offshore sand and gravel is likely to be profitable at selected sites well before mining of most other offshore minerals. Sand and gravel occurs in enormous quantities on the U.S. continental shelf. However, due to onshore sources of supply in many parts of the country, the low unit value of the resource, and significant costs to transport sand and gravel long distances, profitable offshore sand and gravel mining is likely to be restricted to areas near major metropolitan centers that have depleted nearby onshore sources and/or have encountered conflicting land use problems.

Sand and gravel are currently being dredged in State waters in the Ambrose Channel between New York and New Jersey. This operation, begun 2 years ago, is the only offshore sand and gravel mining currently taking place in U.S. waters. The Great Lakes Dredge & Dock Co., the dredge operator, mines approximately 1.5 million cubic yards per year of high-quality fine aggregate from the channel. This aggregate is sold to the concrete ready-mix industry in the New York/New Jersey area at an average delivered price of \$11.50 per cubic yard. The Federal Government benefits from this operation because it enables the Ambrose Channel, which is a major navigation channel into New York Harbor, to be maintained at significant savings to the government. In addition, both New York and New Jersey receive royalties of 25 cents per cubic yard of aggregate mined.

Great Lakes Dredge & Dock uses one trailing suction hopper dredge in its operation. The dredge is authorized to mine to a depth of 53 feet below the mean low water mark. When full, the dredge proceeds to a mooring point about one-half mile offshore South Amboy, New Jersey. The aggregate is then pumped to shore via a pipeline. The company estimates that there is enough sand and gravel in the channel to operate for 10 to 15 more years (longer if the channel is widened and/or deepened).

Sand and gravel mining has not yet occurred in the U.S. Exclusive Economic Zone, but the Bureau of Mines has tentatively identified two metropolitan areas, New York and Boston, where significant potential exists for the near-term development of offshore sand and gravel deposits. * Local onshore supplies are fast becoming depleted in these areas. The Bureau estimates that, for both areas, dredge and plant capital costs would range from a low of about \$21 million for a 1.3-million cubic-yard-per-year operation 10 nautical miles from an onshore plant to a high of \$145 million for a 6.7-million cubic-yard-per-year operation 80 nautical miles from shore. Operating costs for a product that has been screened (i.e., sorted) are estimated to range from about \$3.30 per cubic yard for the smaller nearshore operation to \$4.00 for the larger, more distant operation. Estimates are based on 250 operating days per year for the dredge and 323 for the plant. Other cities where offshore sand and gravel eventuality could be competitive include Los Angeles, San Juan, and Honolulu.

● *An Economic Reconnaissance of Selected Sand and Gravel Deposits in the U.S. Exclusive Economic Zone*, Open File Report 3-87 (Washington, DC: U.S. Bureau of Mines, January 1987).

There are no active facilities for processing chromite in the Pacific Northwest. Ferrochromium plants and chromium chemicals and refractories producers are concentrated in the eastern half of the country. However, one company, Sherwood Pacific Ltd., was recently formed for the purpose of constructing and operating a chromium smelter in Coos Bay, Oregon. Coos Bay has a deep draft ship channel, rail access, land, and a work force. Initial raw material for the smelter is expected to come from onshore deposits in southern Oregon and northern California.

The costs per ton of concentrate projected in this scenario allow only small margins to make and dis-

tribute a finished product, currently worth about \$40 per ton. Hence, it is clear that chromite alone would not be worth recovering. Unless the price of chromite were to increase or byproducts such as gold or zircon could be economically recovered, the costs projected in this scenario do not justify economic chromite mining in the near future.

Offshore Placer Gold Mining Scenario

Location.—Gold-bearing beach sands were discovered and mined at Nome, Alaska, in 1906. Mining gradually extended inland from the current shoreline to old shorelines now above sea level. By

1906, about 4.5 million ounces of alluvial gold had been mined from a 55-square-mile area. Early miners recognized that the Nome gold placers were formed by wave action and that additional deposits, formed when sea levels were lower, should be found in the adjacent offshore area (figure 5-20).

Two U.S. companies, ASARCO and Shell Oil Co., sampled offshore deposits near Nome in 1964 and recovered alluvial gold. By 1969, proven reserves offshore of approximately 100 million cubic yards of ore had been established. The rights to these reserves were acquired in 1985 by Inspiration Resources, which then began a pilot mining and testing program. This program was followed by mining tests with a bucket ladder dredge in 1986. All operations to date have taken place within 3 miles of shore in waters under the jurisdiction of the State of Alaska, although gold resources have been identified out to about 10 miles. The future offshore gold mining operation is examined in this scenario, based on a number of assumptions.

Operational and Geological Characteristics.—Nome is a small town near the Arctic Circle on Norton Sound, a large shallow bay open to the west. Water depths in the bay do not exceed 100 feet. Ten miles offshore water is only 60 feet deep. Gold-bearing sediments are a maximum of 30 feet thick and consist of bedded sands, gravels, and clays alternating with occasional beds of cobbles and boulders. These sediments were sampled from the ice out to about 1½ miles from the coast. Gold has been found further offshore, but reserves have not yet been fully delineated. Current mining sites are located less than 1½ miles offshore in water depths averaging 30 feet and in formations 6 to 30 feet thick.

Only between June and October is Norton Sound ice-free and accessible to floating vessels. During the winter, thick pack ice forms over the Sound. Waves reportedly do not exceed periods of 7 seconds, but occasional sea-swells with longer periods may come from the west or southwest. Predominant winds are from the north and northeast. Currents and longshore drift are westward. Maximum tides are 6 feet.

Mining Technology.—The *Bima*, a bucket ladder dredge built in 1979 for mining tin offshore Indonesia, was selected to mine the offshore gold

placers. The *Bima* was brought to Nome in July 1986 for preliminary tests. It was modified in Seattle and is scheduled to begin operation in July 1987. The *Bima* was designed and built abroad as a sea-going mining vessel. Its hull is 361 feet long, 98 feet wide, and 21 feet deep. The entire vessel is of steel construction and weighs about 15,000 short tons, including the dredging ladder and machinery. Freeboard is 10 feet and draft 15 feet with the ladder retracted.

The *Bima* is not self-propelled. It must be moved to and from the mining site by a tugboat. On site, the dredge is kept in position by five mooring lines attached to 7-ton Danforth anchors. This anchoring arrangement allows the dredge to swing 600 feet from side to side and to advance while digging. The anchors are positioned and moved by a special auxiliary vessel.

A 15,000-horsepower diesel-electric powerplant is used to operate the bucketline, the ore processing plant, the anchor winches, and the auxiliary systems. There is fuel storage on board for 2½ months of operation.

The *Bima's* dredge ladder and bucketline were originally designed to operate in 150 feet of water. This scenario assumes that the dredge ladder has been shortened, so that the dredge is able to mine from 25 to 100 feet below the water line at the rate of 33 cubic yards per minute or approximately 2,000 cubic yards per hour. The *Bima* was designed to enable the mass of the ladder and bucketline to be decoupled from the motions of the hull by an automated system of hydraulic and air cylinders that act like very large springs. This feature keeps the buckets digging against the dredging face on the seabed while the hull may be heaving or pitching due to the motions of passing waves. During the trials of the *Bima* in Norton Sound from July to October 1986, it was not necessary to activate the system.

At-Sea Processing.—The *Bima* is equipped with a gravity processing plant to make a gold concentrate at the mining site. The throughput capacity of the plant is 2,000 cubic yards per hour. The plant consists of two parallel inclined rotary trommels 18 feet in diameter and 60 feet long. After removal of any large boulders, ore brought up by the dredge bucket slides down the trommels under the spray

Figure 5-20.—Nome, Alaska Placer Gold District

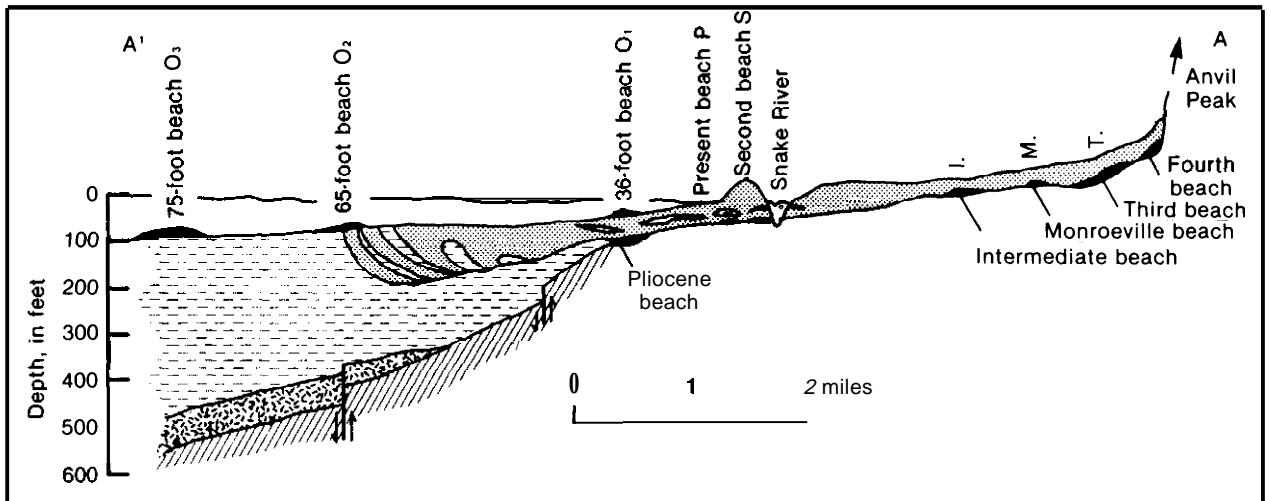
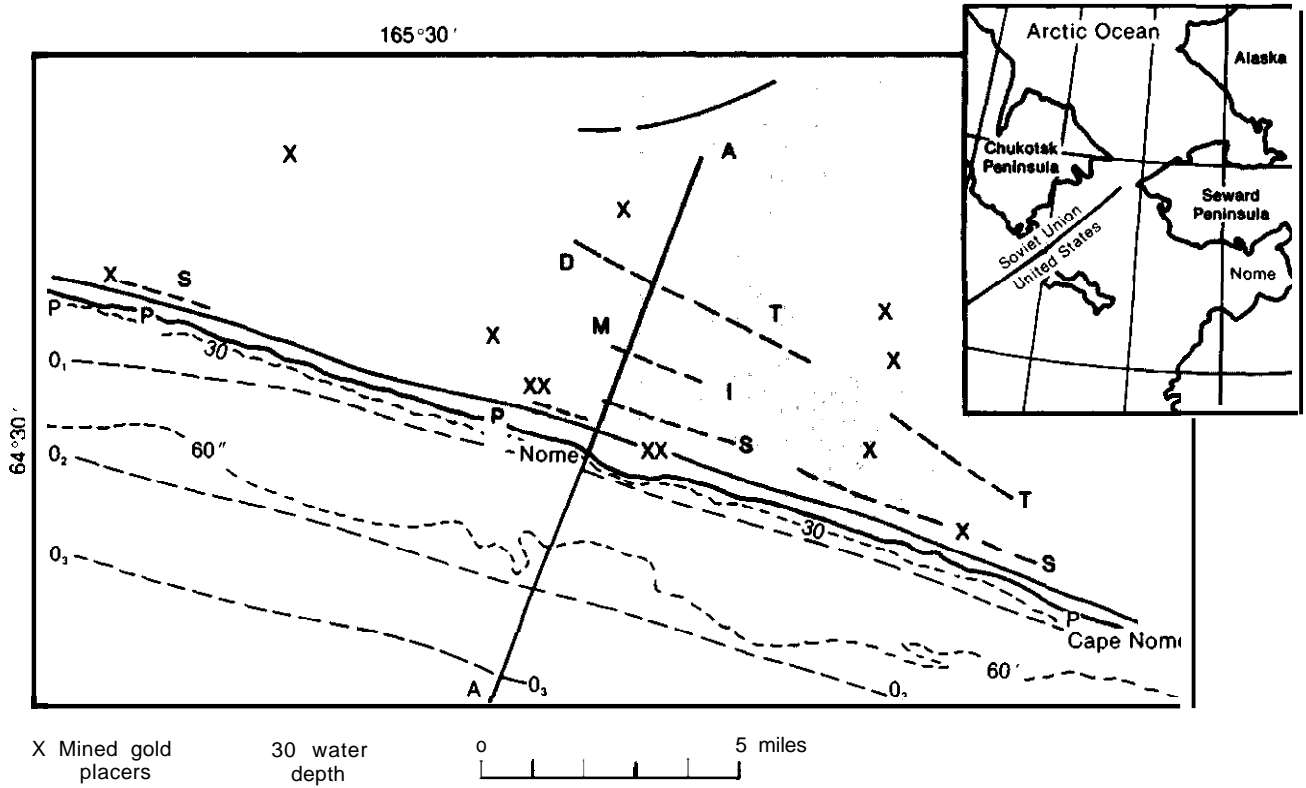

Explanation

- Alluvium ▨ Glacial drift □ Beach sediments □ Marine silt and clay
- ▨ Stratified rocks of unknown type □ Bedrock

Generalized geologic profile of Nome beaches.

SOURCE Adapted from E H Cobbs, U S. Geological Survey Bulletin 1374

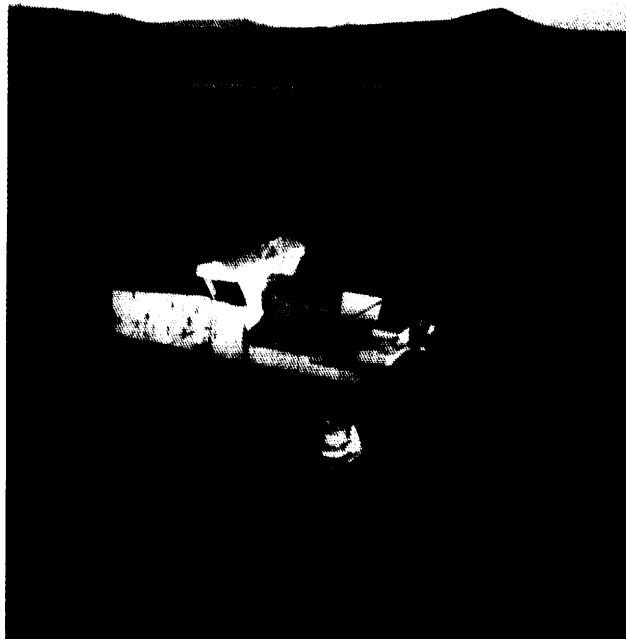

w N m 86



g g



m

BIMA Bucketline Dredge

Photo credit: F.J. Lampietti

of powerful jets of seawater. The water jets are used to break up the clay and force sand and gravel smaller than three-eighths inch to pass through the trommel. Material coarser than three-eighths inch is discharged over the stern.

Material retained by the trommel is distributed in a seawater mixture to three circuits of jigs, beginning with six primary circular jigs 24 feet in diameter. The concentrates from the circular jigs are then fed to crossflow secondary and tertiary jigs.

The jig concentrates are further refined on shaking tables before transport to shore for final gold separation and smelting into bullion. It is expected that about 22 pounds of gold concentrate will be produced by mining and processing approximately 50,000 tons of ore per day. The actual amounts of concentrate produced will depend on the quantity of heavy minerals associated with the gold at each location.

Environmental Effects.—The ore processing plant on the *Bima* returns 99.9 percent of the processed material to the seabed as tailings. Since the tailings do not undergo chemical treatment, local turbidity caused by particles that may remain in suspension is likely to be the most significant environmental impact. During pilot plant tests in 1985, Inspiration Resources found that turbidity could be minimized by discharging fine tailings through a flexible pipe near the seabed. Other potential environmental impacts could occur if diesel fuel is spilled, either as it is being transferred to the *Bima* or as a result of accidental piercing of the hull.

Operating Conditions.—The *Bima* operates only between June and October (five months per year) because ice on Norton Sound prohibits operations during the winter months. Thus, without breakdowns or downtime due to weather and other causes, a theoretical yearly production of about 7.5 million cubic yards of ore is possible. During tests in 1986, *Bima* operated only a small fraction of the time available. This was due more to the nature of the trials than to downtime related to winds and

waves. Assuming a mining efficiency (bucket filling) of 75 percent and an operating efficiency of 80 percent (allowing for time to move and downtime due to weather), yearly production is limited to 4.5 million cubic yards. If gold grades of 0.012 to 0.016 ounces per cubic yard of ore are assumed, the yearly gold production would be between 1.75 and 2.20 short tons (before any losses due to processing and refining).

The *Bima* will have a crew averaging 12 persons per watch, 3 watches per day. Personnel are transported to and from Nome daily by helicopter. The operation also requires extensive maintenance, supply, and administrative facilities onshore. These facilities will be manned by an additional 46 persons during the operating season. During the winter months, the *Bima* will be laid up in Nome harbor, and most of the operating personnel will be on leave.

Capital and Operating Costs.—Capital and operating cost estimates (table 5-6) are based on a number of assumptions and, like the other scenarios in this report, must be considered first order approximations. The estimates rely in part on published information that the *Bima* gold mining project will have a life of 16 years and will recover about 48,000 troy ounces of gold per year at operating costs of less than \$200 per ounce.

The *Bima* was constructed at a cost of \$33 million in 1979. It is assumed that its purchase in 1986 as used equipment (sold because of the fall in the

**Table 5-6.—Offshore Placer Gold Mining Scenario:
Capital and Operating Cost Estimates**

	Millions of dollars
Capital costs:	
Exploration and pilot plant mining tests	\$ 3
Used dredge (BIMA).	3
Dredge transport and insurance from Indonesia to Nome	2
Shipyards modifications	5
Onshore facilities and infrastructure	2
Auxiliary vessels	2
Total capital costs	\$17
Annual operating costs:	
Fuel and lubricants	\$1.5
Personnel and overhead	3.0
Maintenance and spares	1.5
Services	1.0
Annual operating costs	\$7.0

SOURCE⁷ Office of Technology Assessment, 1987

price of tin) is on the order of \$5 million. Also assumed is that other capital costs, including ancillary facilities onshore; pilot-plant mining tests in 1985 and trials in 1986; auxiliary vessels for prospecting and for tending anchors; shipyard modifications and alterations to the processing plant; and the cost of shipment of the *Bima* from Indonesia to Nome and to and from the shipyard near Seattle will amount to another \$10 million to \$15 million. Total capital costs are thus assumed to be between \$15 million and \$20 million.

Annual operating costs for fuel, maintenance, insurance and administration, and personnel and overhead are estimated (to an accuracy of 25 percent) to be \$7 million. At a production rate of 48,000 ounces per year, a cash operating cost on the order of \$150 to \$175 per ounce is implied. At a mining rate of approximately 4.5 million cubic yards per year, direct costs would amount to \$1.55 per cubic yard.

Assuming the price of gold to be \$400 per troy ounce, the projected pre-tax cash flow on a production of 48,000 troy ounces per year would be approximately \$12 million (after subtracting operating costs) on an investment of \$17 million. Although this figure does not include debt service, it nevertheless indicates that the *Bima* offshore gold mining project at Nome shows good promise of profitability if the operators are able to maintain production. This scenario illustrates that offshore gold mining is economically viable and technically feasible using a bucketline dredge under the conditions assumed.

Offshore Phosphorite Mining Scenarios: Tybee Island, Georgia and Onslow Bay, North Carolina

Two different phosphorite mining scenarios were considered by OTA. The first, located off Tybee Island, Georgia, was developed by Zellars-Williams, Inc., in 1979 for the U.S. Geological Survey. The second was developed by OTA in the course of this study. Although the two scenarios differ in location and in the assumptions concerning onboard and onshore processing of the phosphorite minerals, breakeven price estimates of the two cases are well within overlapping margins of error.

Both scenarios should be considered little more than rough estimates of costs based on hypothetical mining conditions and technology. In some cases—particularly with the OTA scenario—assumptions are made about the adaptability of onshore flotation and separation techniques to at-sea conditions. Not only would additional technological development and testing be needed to adapt existing technology for onboard use, but even the feasibility of secondary separation and flotation processing at sea would also probably need further assessment and testing.

The actual costs of capitalizing and operating an offshore mining operation can vary significantly from OTA's estimates. However, in both scenarios, the results suggest that further evaluation—particularly to better define the potential resources and to consider processing technology—might be worthwhile.

While further assessment of the potential for mining phosphorite minerals offshore may be warranted, the overall condition of the domestic onshore phosphate industry cannot be ignored when evaluating the feasibility of offshore operations. The future of the U.S. phosphate mining industry seems bleak in the face of increased low-cost foreign production. Some fully depreciated mines are currently finding it difficult to meet foreign competition. New phosphate mines, either onshore or offshore, will likely find it difficult to compete with foreign operations.

If exceptionally rich phosphate resources are discovered offshore, or if offshore mining and processing systems can reduce costs through increased productivity or offsetting land use and environmental costs, the commercial prospects for offshore development might improve. However, higher phosphate prices would also be needed to make the economic picture viable, and most commodity analysts do not think higher prices are likely. Table 5-12 compares Tybee Island and Onslow Bay scenarios.

Tybee Island, Georgia

Location.—Onshore and offshore phosphorite deposits are known to occur from North Carolina to Florida. The potential for offshore mining of phosphorite in EEZ waters adjacent to the north-

ern coast of Georgia was examined in some detail in a 1979 study by Zellars-Williams, Inc. , for the Department of the Interior. To illustrate the technical and economic feasibility of offshore phosphorite mining, OTA has drawn heavily from Zellars-Williams work.

The Zellars-Williams study considers a 30-square-mile area located about 12 miles offshore Tybee Island, Georgia, not far from the South Carolina border and in the same general area considered in the titanium scenario (figure 5-17). Only scattered, widely spaced samples have been taken in the vicinity, and none within the scenario area itself. These samples and some seismic data suggest the occurrence of a shallow phosphorite deposit in the area, but much more sampling is required to fully evaluate the deposit. The mine site is attractive for several reasons:

- water depths are uniform over the entire block, with a mean depth of 42 feet;
- the area is free of shipwrecks, artificial fishing reefs, natural reefs, rock, and hard bottom;
- the area is close to the Savannah Harbor entrance but not within shipping lanes for traffic entering the harbor; and
- an onshore plant site is available with an adequate supply of river water for process use, including washing of sea salts.

Operational and Geological Characteristics.—Average windspeed during the year at the site is about 7 miles per hour with peaks each month up to 38 miles per hour. Winter surface winds are chiefly out of the west, while in summer north and east winds alternate with those from the west. Severe tropical storms affect the area about once every 10 years and usually occur between June and mid-October. The most severe wave conditions result from strong fall and winter winds from the north and west, but the proposed mining site is sheltered by land from these directions. Waves of 12 feet or more occur about 2.5 percent of the year while 4-foot waves occur 57 percent of the year. The maximum spring tidal range is about 8 feet. Current speeds are low, about 3 to 4 miles per day. Heavy fog is common along the coast, and Savannah experiences an average of 44 foggy days a year.

Phosphorite ore occurring as pebbles and sand at the mine site is part of what is known as the

Savannah Deposit. The site straddles the crest of the north-south trending Beaufort Arch, which suggests that the top of the phosphatic matrix will be closest to sea level in this area. The ore body lies beneath 4 feet of overburden. It is assumed that the ore body is of constant thickness over a reasonably large area and that the mine site contains 150 million short tons of phosphorite. The average grade of the ore is assumed to be 11.2 percent phosphorous pentoxide (P_2O_5).

Mining Technology.—An ocean-going cutter suction dredge with an onboard beneficiation plant is selected for mining. The dredge is equipped with a 125-foot cutter ladder, enabling it to dredge to a maximum depth of 100 feet below the water surface, more than enough to reach all of the mine site deposit. The dredge first removes the sandy overburden in a mine cut and places it away from the cut or in a mined-out area. Phosphate matrix then is loosened by the rotating cutter, sucked through the suction pipe, and brought onboard the dredge. The dredge is designed to mine approximately 2,500 cubic yards of phosphate matrix per hour. It is estimated that approximately 450 acres of phosphate matrix are mined each year. Mining cuts are 1 mile long and 800 feet wide.

Processing Technology.—Onboard processing consists of simple mechanical disaggregation of the matrix followed by size reduction. Oversize material is screened with trommels and rejected. Undersize material (mainly clays) is removed using cyclones. The undersize material is flocculated (thickened to a consistency suitable for disposal) and pumped to the sea bottom.

On shore, the sand size material is subjected to further washing and sizing. Tailings and clays are returned to the mine site for placement over the flocculated clays. Phosphate is concentrated to 66 percent bone phosphate of lime (BPL) by a conventional flotation sequence. The wet flotation concentrate is then blended and calcined to 68 percent BPL (approximately 30 percent P_2O_5).

It is assumed that, initially, 2.5 million short tons per year of phosphate rock are produced. Eventually, the amount produced would increase to the optimum rate of 3.5 million tons. It is also assumed that only 4 cubic yards of ore would need to be dredged per ton of final product.

Mining and At-Sea Processing Cycle.—Mining is assumed to take place 80 percent of the available time—292 days or about 7,000 hours per year. The beneficiated ore is loaded continually on 5,500-ton capacity barges for transport to the onshore processing plant. Barge transport is deemed necessary for both economic and pollution control reasons. A tug picks up one barge at a time, taking it to a mooring point just outside the channel at the Savannah River entrance. A push boat then takes a four-barge group about 20 miles upstream to the processing facility. After the ore is discharged, the barges are reloaded with tailings sand and returned to the mooring point. The tug then returns the barge to the mining area, initially to discharge tailings and then to be taken to the dredge and left to be filled with feed.

Capital and Operating Costs.—Capital and operating cost estimates for the Zellars-Williams scenario (table 5-7) have been updated to reflect changes in plant, equipment, wages, and other cost factors. The revised figures are expressed in 1986 dollars. Capital and operating costs include costs for dredging and primary concentration, transportation of beneficiated ore to port, onshore processing to 66 percent BPL, calcining to 68 percent BPL, contingency, and working capital.

The Zellars-Williams scenario and associated costs are regarded as a “best-case” situation. 19 In

¹⁹More information about the Zellars - Williams and other phos-

phorite studies may be found in the OTA contractor report “Offshore Phosphorite Deposits: Processing and Related Considerations, by William Harvey. November 1986.

1986 dollars, the operating costs to mine and wash the ore and to transport the primary concentrate to an onshore processing plant amount to about \$4.60 per short ton. Onshore processing would cost about \$10 per short ton, and a depreciation expense of almost \$10 per ton must be added to this figure. Hence, a “breakeven” price for calcined concentrate would be close to \$25 per short ton. Calcined concentrate, however, is currently selling for only \$19 to \$25 per short ton, depending on grade and whether the product is sold domestically or exported. Furthermore, given uncertainties such as costs for mitigating environmental impacts, the acceptability of at-sea disposal of flocculated clays, and the uncertain effectiveness of both dredging and processing technology in the offshore environment, investors would probably require a discounted cash flow return larger than the 16.5 percent return indicated in the Zellars-Williams study. The breakeven price does not include additional requirements for profit and risk,

The largest component of total capital cost and of total operating cost is for onshore processing of the primary concentrate to 66 percent BPL, and the second largest cost component is for calcining to 68 percent BPL. Savings might be possible if an existing onshore processing plant could be used for flotation and/or calcining or if flotation at sea be-

**Table 5-7.—Offshore Phosphorite Mining, Tybee Island, Georgia:
Capital and Operating Cost Estimates**

	Millions of dollars	
Capital costs:		
Dredging and primary concentration		\$17
Transport to port		26
Processing to 66 percent BPL		80
Calcining to 68 percent BPL		33
Contingency		15
Working capital		14
Total		\$185
	(million \$/year)	(\$/ton product)
Operating costs:		
Dredging and primary concentration	\$ 9	\$2.50
Transport to port	7	2.10
Processing to 66 percent BPL	22	6.20
Calcining to 68 percent BPL	12	3.50
Contingency	2	0.70
Total	\$52	\$15.00

SOURCE: Zellars-Williams, Inc., “Outer Continental Shelf Hard Minerals Leasing: Phosphates Offshore Georgia and South Carolina,” report prepared for U.S. Geological Survey, May, 1979. Figures updated by OTA contractor, William Harvey

comes technically and economically feasible. While there is no existing facility within a reasonable distance of the Savannah Deposit, phosphorite ore located off the coast of North Carolina (Onslow Bay) potentially could be processed at the existing onshore facility near Moorhead City.

The following scenario, developed by OTA, examines the feasibility of mining the Onslow Bay deposits, of using onboard flotation to upgrade the ore to 66 percent BPL, and of using the existing facility at Moorhead City for calcining to 68 percent BPL.

Onslow Bay, North Carolina

Location.—A high-grade offshore phosphorite resource is described by Riggs²⁰ and others on the continental shelf adjacent to North Carolina. The resource is located at the southern end of Onslow Bay 20 to 30 miles southeast of Cape Fear (figure 5-21). A Federal/State task force was established in 1986 to investigate the future of marine mining offshore North Carolina. The task force has hired Development Planning & Research Associates to study the feasibility of mining Onslow Bay phosphorite; however, no private companies have expressed an immediate interest in mining offshore phosphorite in this area.

The Miocene Pungo Formation is a major sedimentary phosphorite unit underlying the north-central coastal plain of North Carolina. It is mined extensively onshore. The seaward extension of the Pungo Formation under Onslow Bay has been studied using seismic profiling and vibracore sampling methods. The site selected for this scenario is where the Frying Pan Phosphate Unit of the Pungo Formation outcrops offshore in a band 1 to 2½ miles wide and about 18 miles long.

Operational and Geological Characteristics.—The site is characterized by open ocean conditions consisting of wind waves from the northeast and long period swell. Winds gusting above 30 knots occur less than 15 percent of the time. Currents are less than 1 knot and tidal influence is negligible. Hurricanes and associated wave conditions occur on an average of 10 days per year.

The phosphorite formation consists of fine, muddy sands covering an area of 45 square miles. Overburden consists of loose, fine, sandy sediment varying in thickness from 0 to 8 feet. Underneath, the phosphorite sand has a thickness between 1 and 10 feet. Water depth averages about 80 feet; hence, the total mining depth is not expected to exceed 98 feet. The overburden contains an average of 6.3 percent P₂O₅. The phosphorite unit contains between 4.8 and 22.9 percent P₂O₅, with an average of 12.4 percent by weight.²¹ Laboratory analysis of phosphate concentrates indicates the presence of no other valuable minerals.

Mining Technology.—A trailing suction dredge with an onboard beneficiation plant is selected as the most appropriate technology for the water depth and geological characteristics of the deposit. It is assumed that the phosphorite unit and overburden are sufficiently unconsolidated to be mined by suction dredging methods without the need for a cutter head. Only water jets and passive mechanical teeth are used. The dredge and plant are housed in a specially designed ship-configured hull. The vessel is not a self-unloading hopper dredge and has only a small storage capacity on board. The beneficiated ore is discharged onto barges or small ore carriers which are continuously in attendance behind the mining vessel and which shuttle back and forth to the unloading point near the shore processing plant. Dredging capacity is about 2,000 cubic yards per hour; 75 percent dredging efficiency is assumed. The suction head is kept on the seabed by a suction arm that compensates for the motion of the vessel in ocean swell. The vessel is self-propelled, dredges underway, and is equipped with precision position-keeping instrumentation.

The above configuration is preferred to hopper dredging because either a very large single hopper dredge or several smaller hopper dredges would be needed to meet the mining production requirements.

Processing Technology.—At-sea processing is assumed to consist of:

- conventional mechanical disintegration and screening to eliminate oversize material,

²⁰S.R. Riggs, et al., "Geologic Framework of Phosphate Resources in Onslow Bay, North Carolina Continental Shelf," *Economic Geology*, vol. 80 (1985), p. 735.

²¹ Ibid.

Figure 5-21.—Offshore Phosphate District, Southeastern North Carolina Continental Shelf

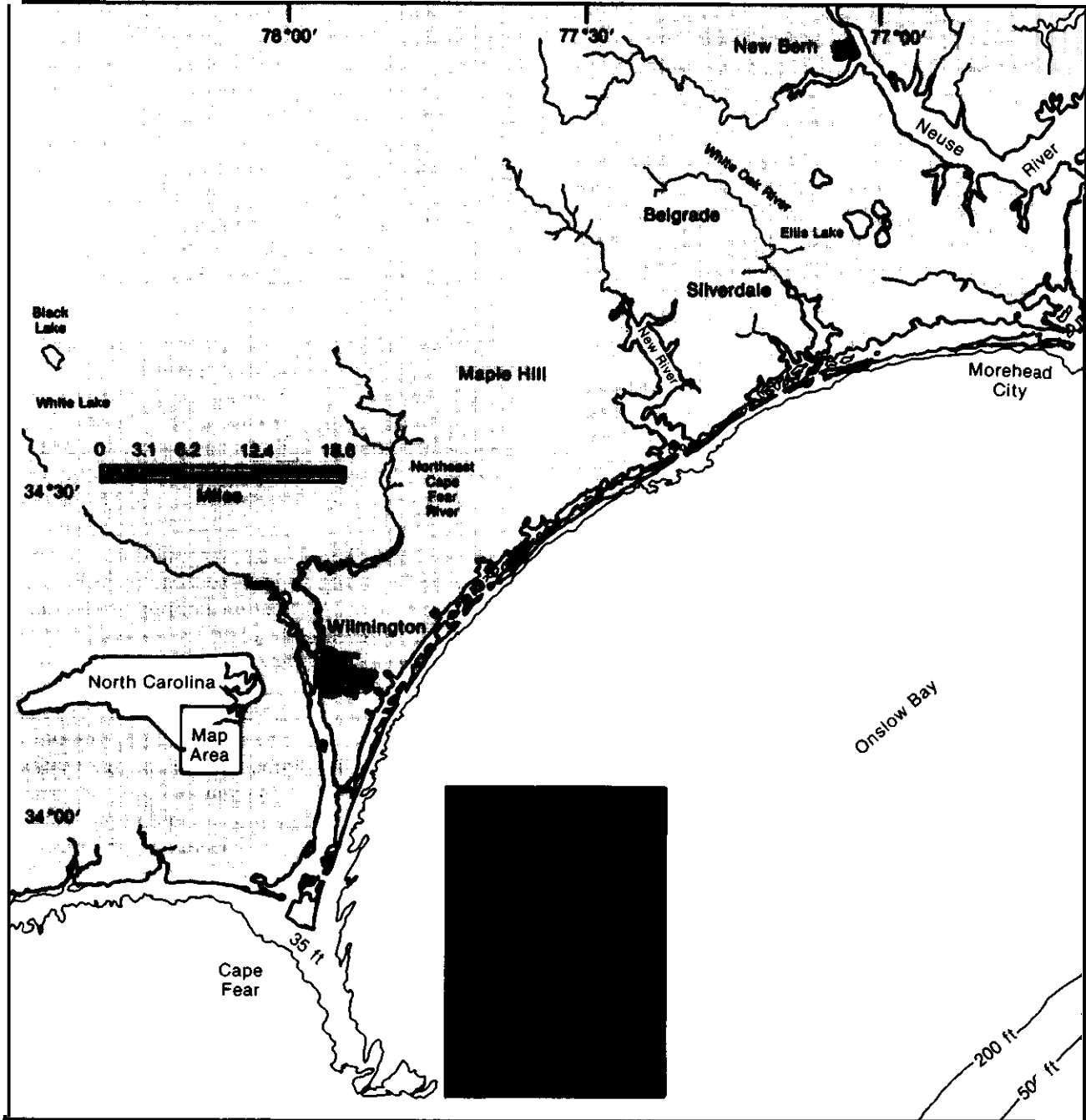

SOURCE: Adapted from S.H. Higgs, S.W. Snyder, A.C. Hine, S.W. Snyder, M.D. Ellington, and P.M. Mallette, "Geologic Framework of Phosphate Resources in Onslow Bay, North Carolina Continental Shelf," *Economic Geology*, Vol 80, 1985, p. 720.

- cycloning to reduce undersize material (e. g., clays), and
- flotation to reject silicates.

Rejected material is returned to the sea floor. The assumption that flotation can be adapted to shipboard operation requires verification by development and testing studies, the costs of which are provided for under the capital cost estimates below. The use of an existing (and, therefore, already capitalized) onshore calcining plant near Moorhead City, North Carolina, some 80 miles north of the mine site, is also assumed.

Assuming that P_2O_5 makes up 12.4 percent (by weight) of the Frying Pan unit and 6.3 percent of the overburden (both of which are mined), the mined feed to the at-sea processing plant contains 11.2 percent P_2O_5 by weight. A total of 6.9 million short tons of ore are mined each year at the dredging rate of 2,000 cubic yards per hour, yielding a shipboard concentrate of about 1.7 million tons for feed to the calcining plant onshore. This yield assumes that shipboard ore flotation upgrades the P_2O_5 content to 30 percent.

Mining and At-Sea Processing Cycle.—It is estimated that six barges, each with a capacity to carry 6,550 cubic yards of beneficiated ore, and two

tugs will be required to conduct efficient and nearly continuous loading while the mining vessel is on station. The time required to load three barges, transit to shore, unload, and return to the mining vessel is expected to be 3 days. The mining vessel is assumed to operate 82 percent of the time, or 300 days per year.

Capital and Operating Costs.—The capital and operating cost estimates (table 5-8) are based on the assumption that new equipment is provided to supply beneficiated ore to an existing shore-based calcining plant. The capital costs of this shore-based plant are not included in the following estimates that may vary by as much as a factor of 2 or more.

Estimated annual operating costs are \$20 per short ton. The estimated costs do not include capital recovery or the profit and risk components that would be required to attract commercial investors to an untried venture. Capital recovery alone over 20 years for a \$71 million loan at a 9 percent interest rate would add an additional \$8 per short ton of product. The current market price of comparable phosphate rock is about \$21 per short ton. Hence, the potential for mining phosphorite in Onslow Bay would not be immediately attractive to commercial investors.

**Table 5-8.—Offshore Phosphorite Mining, Onslow Bay, North Carolina:
Capital and Operating Cost Estimates**

	Millions of dollars	
Capital costs:		
Detailed exploration, metallurgical testing and feasibility studies		\$ 4
Mining and beneficiation vessel		41
Transportation to shore (tugs and barges with capacity to deliver 20,000 cubic yards every 3 days)		16
Loading, unloading, and storage installations		10
Total capital costs		\$71
	(million \$/year)	(\$/ton product)
Operating costs:		
Mining	\$ 9	\$ 5.00
Processing to 66°A bone phosphate of lime (BPL) offshore	12	7.00
Transport and handling	5	3.00
Calcining to 68 percent BPL (31 percent phosphorous pentoxide) onshore	8	5.00
Total operating costs	\$34	\$20.00

SOURCE Off Ice of Technology Assessment, 1987

Table 5-9.—Scenario Comparisons: East Coast Placer

	Bureau of Mines (January 1987)	OTA
Deposit kind	Ilmenite, rutile, zircon, etc. in old shorelines	Ilmenite, rutile, zircon, etc. in old shorelines
Grade	Approx. 5% economic heavy minerals by weight	5 to 15% total heavy minerals (economic % heavy mineral not specified)
Size100 million short tons	Not specified
Distance to shore unloading point	80 nautical miles	100 nautical miles
Maximum dredging depth	150 feet	120 feet
Annual mining capacity—tonnage dredged.	2.5 to 5.0 million short tons	3.2 to 9.5 million short tons
Mining system.	Domestic built new hopper dredge with an onboard new beneficiation plant	Domestic built new hopper dredge with an onboard beneficiation plant
Mining system operating days	250	300
Shore processing plant	New, to produce saleable heavy mineral products	New , to produce saleable heavy mineral products
Capital costs (million \$):		
Dredge	25.9 to 49.7	
Plant and other	16.3 to 24.5	
Total	42.2 to 74.2	55 to 86
Direct cash operating costs \$U.S. per short ton dredged	4.55 to 3.79	4.72 to 2.2
Comments (OTA's)	<ul style="list-style-type: none"> • Technically feasible but economically marginal for heavy mineral grades assumed • No estimate of accuracy of scenario • Costs most sensitive to distance from shore 	<ul style="list-style-type: none"> • Accuracy of scenario not estimated • Costs most sensitive to heavy mineral grade

SOURCE: Office of Technology Assessment, 1987.

Table 5-10.—Scenario Comparisons: West Coast Placer

	Bureau of Mines (January 1987)	OTA
Deposit kind	Chromite with minor titanium, zircon, and gold	Chromite with insignificant amounts of ilmenite, rutile, and gold
Grade	>6% Cr ₂ O ₃ + .0048 oz. Au per short ton	6% Cr ₂ O ₃
Size50 million short tons	Not specified
Distance to shore unloading point	40 nautical miles	75 nautical miles
Maximum dredging depth . . .	150 feet	300 feet
Annual mining capacity— tonnage dredged.	5,000,000 short tons	4,500,000 short tons
Mining system.	Domestic built new hopper dredge	Domestic built new hopper dredge
Mining system operating days	250	300
Shore processing plant	New, to produce saleable mineral products	New, to produce saleable mineral products
Capital costs (million \$):		
Dredge	41.4	40.0
Plant and other	44.3	17.0
Total	85.7	57.0
Direct cash operating costs \$U.S. per short ton dredged	5.42	4.00
Comments (OTA's)	<ul style="list-style-type: none"> • Technically feasible but economically marginal for heavy mineral grades and prices assumed • No operating experience • No estimate of accuracy 	<ul style="list-style-type: none"> • Technically feasible but economically marginal for heavy mineral grades and prices assumed Ž No operating experience • No estimate of accuracy

SOURCE Off Ice of Technology Assessment, 1987

Table 5-11 .-Scenario Comparisons: Nome, Alaska Gold Placer

	Bureau of Mines (January 1987)	OTA
Deposit kind	Gold Placer	Gold Placer
Grade	0.6 gram per yard ³	0.35 to 0.45 gram per yard ³
Size35,000,000 yard ³	80,000,000 yard ³
Distance to shore unloading point	0.5 to 5 miles	0.5 to 10 miles
Maximum dredging depth . . .	80 feet	90 feet
Annual mining capacity— tonnage dredged.	1,632,000 yd ³	4,500,000 yd ³
Mining system.	Used seagoing bucket line dredge with full gravity processing	Used seagoing bucket line dredge with full gravity processing
Mining system operating days	150	150
Shore processing plant	Minimal for final cleaning of gold concentrates	Minimal for final cleaning of gold concentrates
Capital costs (million \$)		
Dredge		5
Plant and other		10-15
Total	\$9.1	15-20
Direct cash operating costs \$U.S. per yard ³ mined	2.00	1.55
Comments (OTA's)	<ul style="list-style-type: none"> • Technically feasible and appears economically profitable 	<ul style="list-style-type: none"> • Technically feasible and appears economically profitable

SOURCE" Off Ice of Technology Assessment, 1987

Table 5-12.—Scenario Comparisons: Onslow Bay and Tybee Island Phosphorite

	Zellers-Williams (Tybee Island) (updated 1986)	OTA (Onslow Bay)
Deposit kind	Pebbles and sand	Sands
Grade	11.1 percent P ₂ O ₅	11.2 percent P ₂ O ₅
Size	150 million short tons	Not specified
Distance to shore unloading point	30 miles	80 miles
Maximum dredging depth ..	100 feet	98 feet
Annual mining capacity— tonnage dredged.	2.5-3.5 million short tons	6.9 million short tons
Mining system.	Ocean-going cutter suction dredge with onboard screening and cycloning	Trailing suction hopper dredge; onboard screening, sizing, and flotation
Mining system operating days	292 days	300 days
Shore processing plant	Washing and sizing, flotation, calcining	Calcining only
Capital costs (million \$)		
Dredge & offshore processing	\$ 17	\$ 41
Transportation to shore	26	16
Onshore processing	113	—
Other.	29	14
Total	\$185	\$ 71
Cash operating costs \$U.S. per short ton	\$ 25	\$ 28
Comments (OTA's)	<ul style="list-style-type: none"> • Cash operating cost is break-even; Does not include profit and risk. • Estimate considered “best case.” • Estimate may be off by factor of two or more. 	<ul style="list-style-type: none"> • Cash operating cost is break-even; Does not include profit and risk. • Does not include capital costs of existing onshore calcining plant. • Estimate may be off by factor of two or more

SOURCE: Office of Technology Assessment, 1987

Chapter 6
Environmental Considerations

CONTENTS

	<i>Page</i>
Introduction	215
Similar Effects in Shallow and Deep Water	222
Surface Effects	222
Water Column Effects	222
Benthic Impacts	223
Alteration of Wave Patterns	224
Seasonal	224
Different Effects in Shallow and Deep Water	226
Surface Effects	226
Water Column Effects	226
Benthic Effects	226
Shallow Water Mining Experience	227
Deep Water Mining Studies	236
DOMES: The Deep Ocean Mining Environmental Study	236
Follow-Up to DOMES	239
Environmental Effects From Mining Cobalt Crusts	240
Gorda Ridge Task Force Efforts	244

Boxes

<i>Box</i>	<i>Page</i>
6-A. ICES—International Council for Exploration of the Sea	228
6-B. U.S. Army Corps of Engineers	229
6-C. Project NOMES.	230
6-D. New York Sea Grant Studies	231
6-E. EPA/COE Criteria for Dredged and Fill Material	232
6-F. Deep Ocean Mining Environmental Study (DOMES)	237
6-G. Cobalt Crust Case Study	243
6-H. Gorda Ridge Study Results	245

Figures

<i>Figure No.</i>	<i>Page</i>
6-1. The Vertical Distribution of Life in the Sea	216
6-2. Impacts of Offshore Mining on the Marine Environment	217
6-3. Spawning Areas for Selected Benthic Invertebrates and Demersal Fishes.	220
6-4. Composite of Areas of Abundance for Selected Invertebrates Superimposed With Known Areas of High Mineral Potential.	221
6-5. The Effect of Discharge Angle and Water Current on the Shape and Depth of Redeposited Sediments.	235
6-6. Silt Curtain.	236

Tables

<i>Table No.</i>	<i>Page</i>
6-1. Environmental Perturbations from Various Mining Systems	234
6-2. Summary of Environmental Concerns and Potential Significant Impacts of Deep-Sea Mining.	238

Environmental Considerations

INTRODUCTION

Mineral deposits are found in many different environments ranging from shallow water (sand, gravel, phosphorites, and placers) to deep water (cobalt crusts, polymetallic sulfides, and manganese nodules). These environments include both the most biologically productive areas of the coastal ocean as well as the almost desert-like conditions of the abyssal plains. (See figure 6-1.)

Given this broad spectrum, it is hard to generalize about the effects of offshore mining on the marine environment. However, a few generic principles can be stated. ¹As long as areas of importance for fish spawning and nursery grounds are avoided, **surface** and **mid-water** effects from either shallow or deep water offshore mining should be minimal and transient. Benthic effects (i. e., those at the seafloor) will be the most pronounced for any mining activity in either shallow or deep water. Animals within the path of the mining equipment will be destroyed; those nearby may be smothered by the “rain of sediment” returning to the seafloor. Mining equipment can be designed to minimize these effects. Barring very extensive mining sites that may eliminate entire populations of benthic organisms or cause extinctions of rare animals, negative impacts to the seafloor are reversible. Most scientists believe that shallow water communities would recover rapidly from disturbance but that recolonization of deep sea areas would be very slow.

Because little offshore mining is going on now, the degree of environmental disturbance that any particular commercial operation might create is difficult to characterize. Even areas that are dredged frequently do not have the same level of disturbance as a continuous mining operation. Nevertheless, U.S. dredging experience is a useful gauge of the potential for environmental impacts. In shallow nearshore waters, a few sand, gravel, and shell mining operations in the United States and Europe in-

dicating possible impacts. In addition, results of research in the United States and abroad offer insights on the effects of offshore mining. These research efforts include:

- the International Council for Exploration of the Sea (ICES) Report of the Working Group on Effects on Fisheries of Marine Sand and Gravel Extraction—box 6-A,
- the U.S. Army Corps of Engineers Dredge Material Research Program (DMRP)—box 6-B,
- the New England Offshore Mining Environmental Study (NOMES)—box 6-C,
- Sea Grant Studies of Sand and Gravel in New York Harbor—box 6-D, and
- National Oceanic and Atmospheric Administration’s (NOAA) Deep Ocean Mining Environmental Study (DOMES)—box 6-F.

The Gorda Ridge Draft Environmental Impact Statement, and the Cobalt Crust Draft Environmental Impact Statement (see box 6-G) summarize related research as well.

Similarities among the mining systems used for deep water (2,500- 16,000 feet) and shallow water (less than 300 feet) suggest that the same general types of impacts will occur in both environments. Any mining operation will alter the shape of the seafloor during the excavation process, destroy organisms directly in the path of operations, and produce a sediment plume over the seafloor from the operation of the equipment. When the mined material is sorted and separated at the ship, some percentage will be discarded—very little in the case of sand and gravel, a great deal for many other seabed minerals—resulting in a surface “plume” that will slowly settle to the bottom (see figure 6-2). The duration and severity of plume effects on the surface and water column depend on the grain-size of the rejected material. Sand (i. e., particle sizes 0.06 mm-1.0 mm.) settles quickly; silts (.001-.06

¹These conclusions are for mining alone. If any at-sea processing occurs, with subsequent chemical dumping, guidelines may be totally different

²These sediment plumes are the equivalent of the dust clouds produced by similar operations on land.

Figure 6-1.—The Vertical Distribution of Life in the Sea

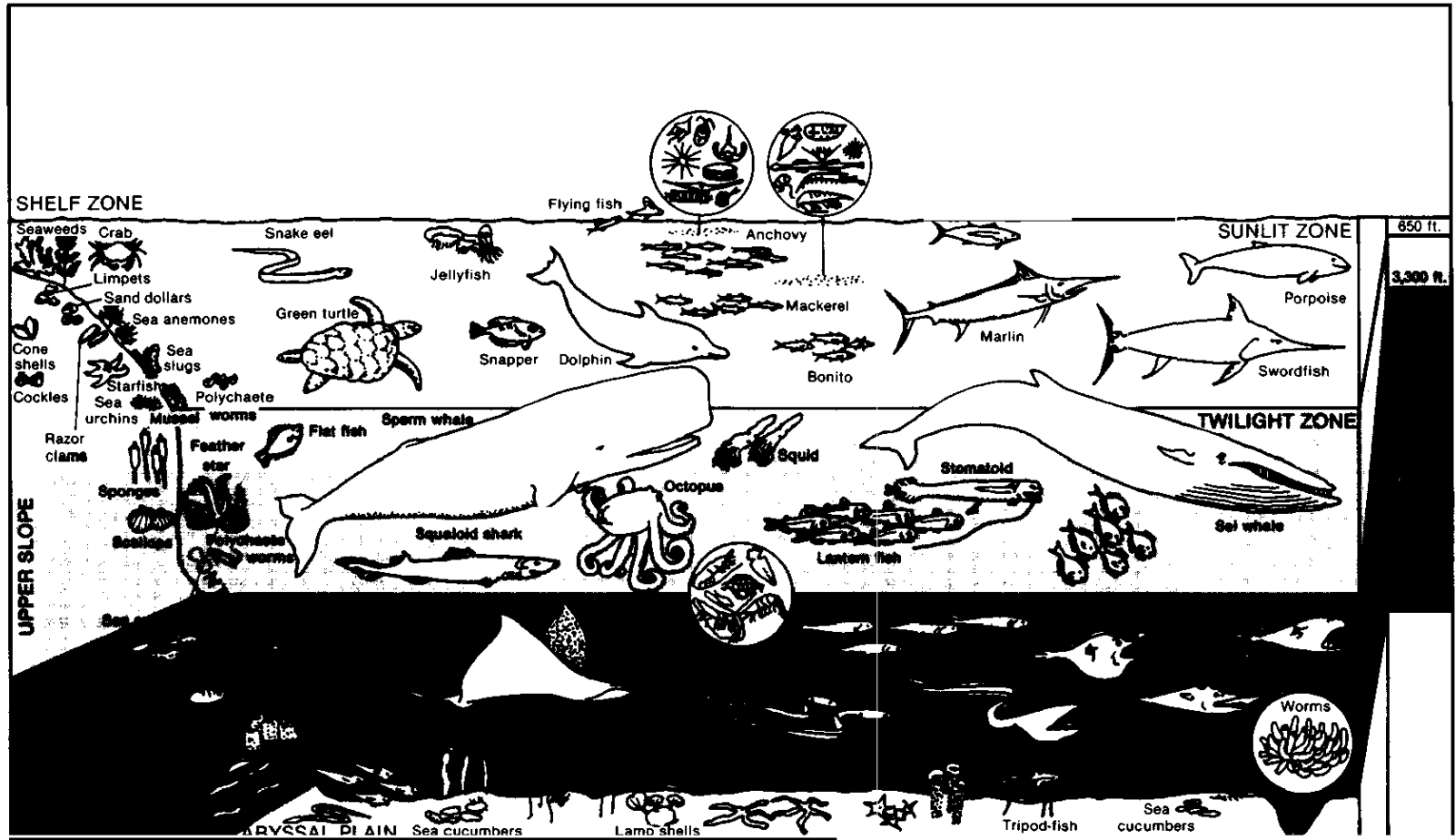

SOURCE: Modified from The Rand McNally Atlas of the Oceans, New York, 1977.

Figure 6-2.—Impacts of Offshore Mining on the Marine Environment

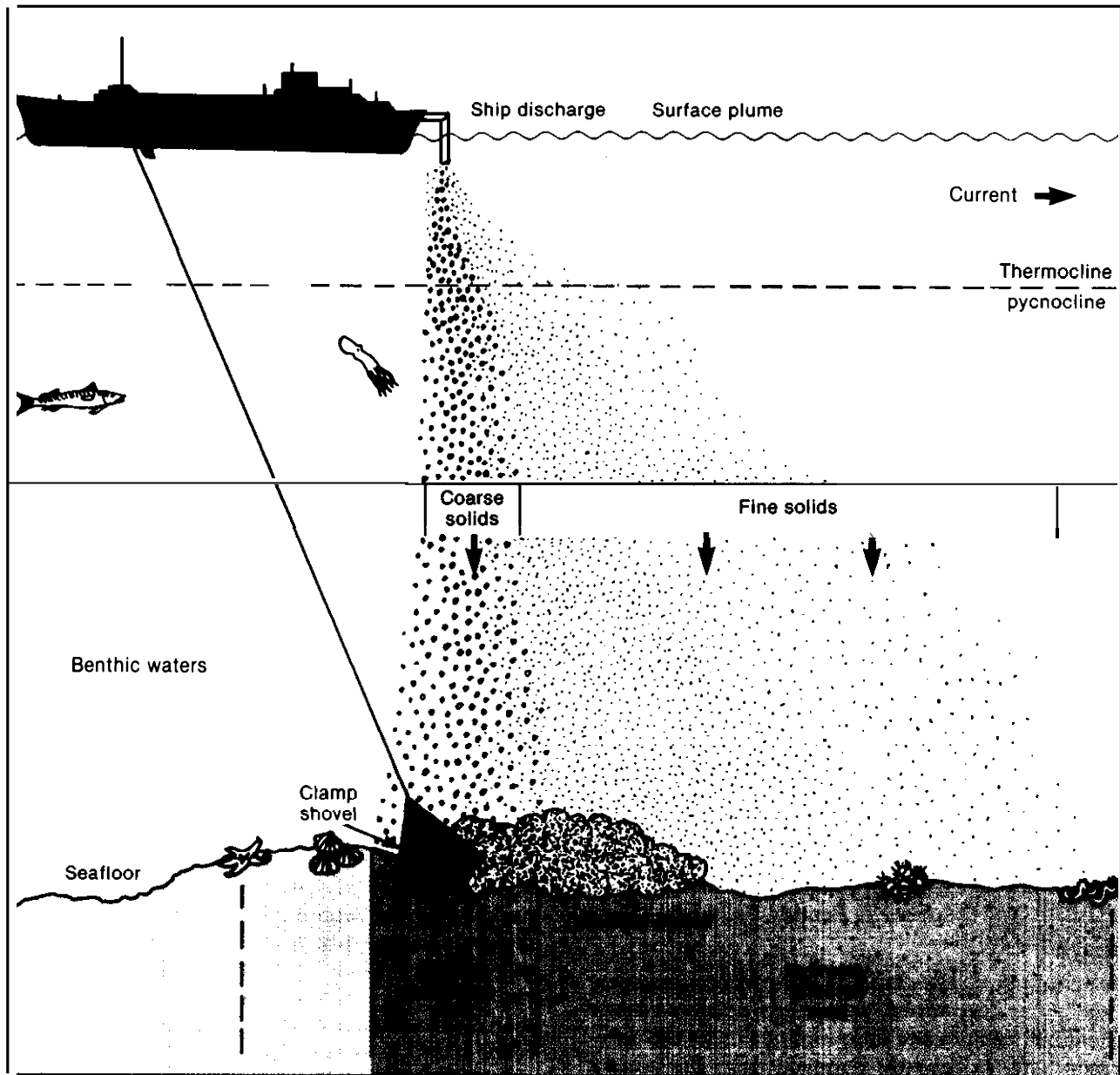

SOURCE: Office of Technology Assessment, 1987.

mm.) and clays (finer than .06 mm.) remain in the water column for a much longer time.

It is not scientifically or economically possible to develop very detailed baseline information on the ecology of all offshore environments in the near future; the consequences of a variety of mining scenarios cannot be precisely predicted. However, presumably environmental impact statements (EIS) will be prepared to identify site-specific problems prior to the commencement of mining operations. Environmental impacts should also be monitored during an actual mining operation. Areas where offshore mining is most likely to pose an environmental risk can be identified now or in the near future using existing data. (e. g., see figure 6-4 showing areas of high biological productivity superimposed on a map, produced by the Strategic Assessment Branch of NOAA, depicting areas of high mining potential.) For shallow water environments, areas considered sensitive because of unique plant or animal species, spawning or nursery areas, migration pathways, fragile coastline, etc., should be prohibited from mining activities (see figure 6-3); this approach is being pursued in the United Kingdom and Canada and is one of the prime recommendations of the International Council for Exploration of the Seas (ICES) Working Group.

Analogues in natural environments that simulate disturbances on the scale of a mining effort should be investigated. For example, insight into the response of the deep-sea to a mining operation can be gained from studying deep-sea areas exposed to natural periodic perturbations such as the HEBBLE³ (High Energy Benthic Boundary Layer Experiment) area.

In addition, when mining does proceed in either shallow or deep water, at least two reference areas should be maintained for sampling during the operation: one sufficiently removed from the impact area to serve as a control, and one adjacent to the mining area.

3. Thistle 1981, "Natural Physical Disturbances and Communities of Marine Soft Bottoms," *Mar. Ecol. Prog. Ser.* 6: 223-228, and B. Hecker, "Possible Benthic Fauna and Slope Instability Relationships," *Marine Slides and Other Mass Movements*, S. Saxov and J. K. Nieuwenhuis (eds.), Plenum Publishing Corp., 1982.

Shallow water effects are better understood than deep water effects because nearshore areas have been studied in detail for a longer time. A great deal is known about the environment and plant and animal communities in shallow water areas. But there has been no commercial mining and much less is known about ecology in deep-sea areas where manganese-cobalt crusts, manganese nodules, and polymetallic sulfides occur. However, there appears to be remarkable uniformity in the mechanisms that control deep-sea environments, so that information gleaned from one area in the deep-sea can be used to make predictions about others; shallow water environments on the other hand, differ significantly from site to site.

One area of shallow water research that requires attention is coastline alteration. Sand, gravel, and placer mining in nearshore areas may aggravate shore erosion by altering waves and tides. A site-specific study would have to be done for each shallow water mining operation to ensure wave climates are not changed. New theories about wave action suggest that, contrary to previous scientific opinion, water depth may be a poor indicator of subsequent erosion. The relative importance of different kinds of seafloor alterations on coastline evolution needs to be clarified. For example, what is the effect of a one-time, very large-scale sediment removal (e. g., at Grand Isle, Louisiana, for beach replenishment over a several mile area) versus cumulative scraping of a small amount over a very long period (such as decades).

The information most needed to advance understanding of the deep-sea is even more basic. The research community needs more and better submersibles to adequately study the deepsea benthos. Currently, there is a 2-year time-lag between research grant approval and available time on one of the two U.S.-owned deepsea submersibles available to the scientific community. Deep-sea biota need to be identified and scientifically classified. Up to 80 percent of the animals obtained from the few samples recovered have never been seen before.⁴ It will be impossible to monitor change in animal communities without systematic survey of these populations. Research funding is needed to develop

⁴B. Hecker, Lament-Doherty Geological Observatory, OTA Workshop on Environmental Concerns, Washington, D. C., Oct. 29, 1986,



Photo credit: S. Jeffress Williams, U.S. Geological Survey

Hallsands once stood on a narrow ledge of rock protected by a cliff and high pebble ridge. The disappearance of this small fishing village was the result of dredging 650,000 tons of gravel offshore over a 4-year period. Removal of such vast quantities of offshore sediments from 1897 to 1901 altered wave patterns and caused beach erosion of 12 to 19 feet by 1904. By 1917, foundations of 29 homes were undermined by the waves and fell into the sea.

the taxonomy of deepsea creatures. Improvements in navigational capabilities are needed; in order to conduct 'before and after' studies, it is important to return to the exact area sampled.

A compendium of available studies and the data produced on both shallow and deep water environments is sorely needed. Unfortunately, a great deal of research on environmental impacts to offshore areas, performed for particular agencies and institutions, has never appeared in peer-reviewed literature. These studies may be quite useful in describing both the unaltered and altered offshore environment and may be directly applicable to proposed mining scenarios. An annotated bibliography summarizing all the information that went into the compilations of MMS Task Forces (see boxes

6-G and 6-H), DMRP, DOMES—see box 6-F, NOMES—see box 6-C, and Information from the Offshore Environmental Studies Program of the Department of Interior developed in conjunction with developing EISS for Oil and Gas Planning Areas would be invaluable. The combined research budgets represented by these efforts is hundreds of millions of dollars. Such data collection could not be duplicated by the private and academic sectors in this century. New research efforts—which tend to be quite modest in comparison—would benefit from easy access to this wealth of information.

An important effort to collect available biological and chemical data and screen them for quality control is underway in the Strategic Assessment Branch of NOAA. Since 1979, NOAA has been

Figure 6-3.—Spawning Areas (June-September) for Selected Benthic invertebrates and Demersal Fishes



This computer-generated map of the Bering, Chukchi, Beaufort Seas area of Alaska shows how information about various species can be combined to develop pictures of offshore areas (in this case, spawning areas) where mining activities may be detrimental.

SOURCE: Strategic Assessment Branch, NOAA,

List of Species Included in Computer-Generated Composite Map

Invertebrates:

- Small crangonid shrimps (*Crangon communis*, *C. dalli*, *C. septemspinosa*)
- Northern Pink Shrimp (***Pandalus borealis***)
- Sidestripe Shrimp (*Pandalopsis dispar*)
- Humpy Shrimp (*Pandalus goniurus*)
- Pandalid shrimp (*Pandalus tridens*)
- Opossum shrimp (*Mysis relicta*)
- Korean Hair Crab (*Erimacrus isenbeckii*)
- Red King Crab (*Paralithodes camtschatica*)
- Golden King Crab (*Lithodes aequispina*)
- Blue King Crab (*Paralithodes platypus*)
- Bairdi Tanner Crab (*Chionoecetes bairdi*)

Fishes:

- Pacific Cod (*Gadus macrocephalus*)
- Walleye Pollock (*Theragra chalcogramma*)
- Yellowfin Sole (*Limanda aspera*)
- Alaska Plaice (*Pleuronectes quadrituberculatus*)
- Greenland Turbot (*Reinhardtius hippoglossoides*)
- Rock Sole (*Lepidopsetta bilineata*)
- Arrowtooth Flounder (*Atheresthes stomias*)
- Flathead Sole (*Hippoglossoides elassodon*)
- Pacific Halibut (*Hippoglossus stenolepis*)

Figure 6-4.—Composite of Areas of Abundance for Selected Invertebrates Superimposed With Known Areas of High Mineral Potential

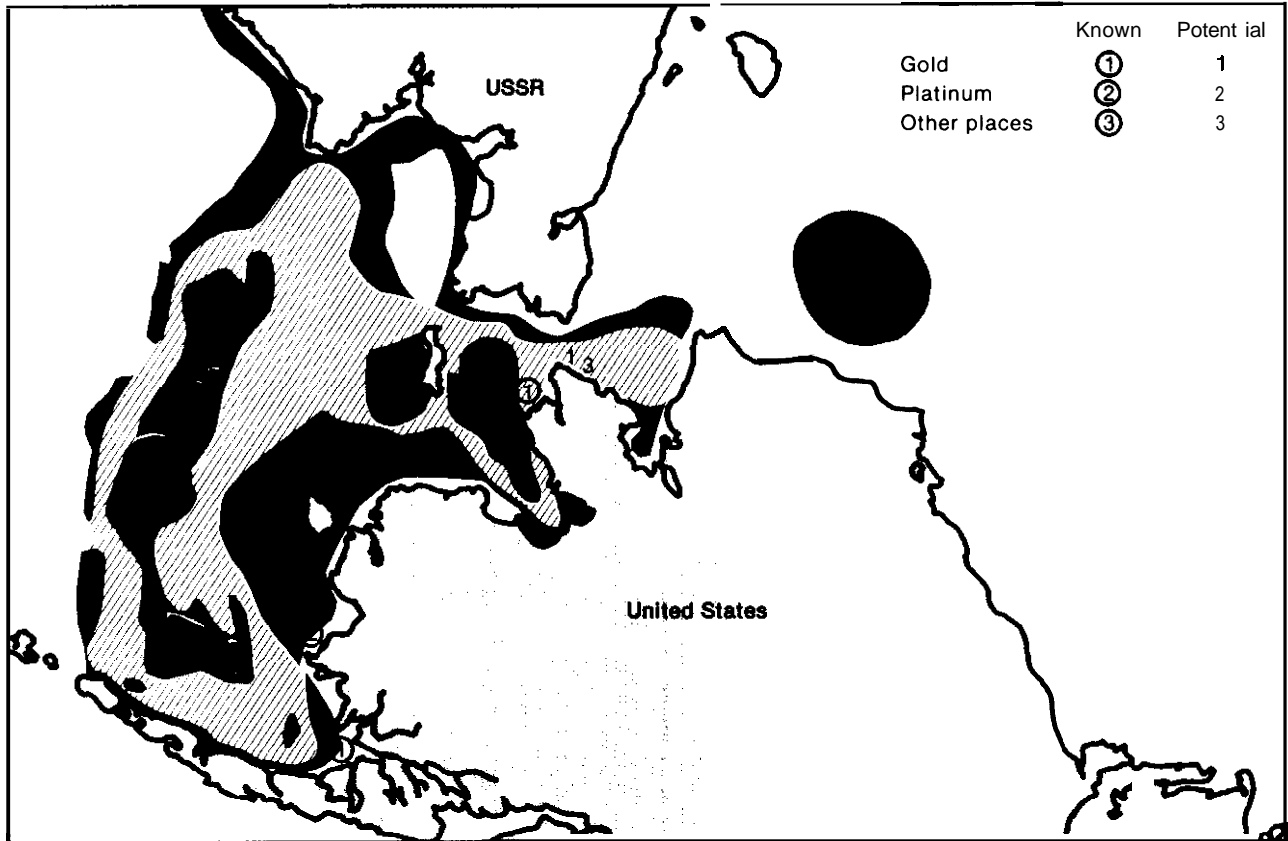

Composite of Areas of Abundance for Selected Benthic Invertebrates
Number of Species

■ -1; □ - 2,3; ● -4,5; ■ -6,7,8

NOTES: Map constructed by combining areas of abundance (i.e., major adult areas and major adult concentrations) from maps of species indicated. Boundaries have been smoothed. Areas depict the number of individual species with relatively high abundance; they do not necessarily reflect the distribution of total biomass.

Species included: Small Crangonid Shrimp (*Crangon communis*, *C. dalli*), Large crangonid shrimp (*Argis dentata*, *Sclerocrangon boreas*), Northern Pink Shrimp, Korean Hair Crab, Red King Crab, Golden King Crab, Blue King Crab, Bairdi Tanner Crab, Opilio Tanner Crab, Chalky Macoma, Greenland Cockle, Iceland Cockle.

SOURCE: Strategic Assessment Branch, NOAA

compiling databases on coastal areas and the Exclusive Economic Zone (EEZ) (see Ch. 7 for more information on this program). These data are being used to develop a series of atlases and can be

used to identify potential conflicts among the multiple uses of resources with given offshore areas (see figures 6-3 and 6-4).

SIMILAR EFFECTS IN SHALLOW AND DEEP WATER

Surface Effects

The surface plume created by the rejection or loss of some of the mined material or the disposal of unused material could cause a number of effects on the phytoplankton (minute plant life) community and on primary production.⁵ In the short term, reduction of available light in and beneath the plume may decrease photosynthesis. Nutrients originally contained in the bottom sediments but introduced to the surface waters may stimulate phytoplankton productivity. Long-term plume effects from long-term continual mining operations

5. T. Chan and G. C. Anderson, "Environmental Investigation of the Effects of Deep-Sea Mining on Marine Phytoplankton and Primary Productivity in the Tropical Eastern North Pacific Ocean, *Marine Mining*, vol 3. (1981), No. 1/2, pp. 121-150.

might lead to changes in productivity or changes in species composition.

Water Column Effects

High particulate concentrations in the water column can adversely affect the physiology of both swimming and stationary animals,⁶ altering their growth rate and reproductive success. Such stresses may lead to a decrease in the number of species,⁷ a decrease in biomass (weight/unit area), and/or

6. D. C. Rhoads, and D. K. Young, "The Influence on Sediment Stability and Community Trophic Structure," *Journal of Marine Research*, No. 28 (1970), pp. 150-178.

7. R. W. Grigg and R.S. Kiwala, "Some Ecological Effects of Discharged Wastes on Marine Life, *California Fish and Game*, No. 56 (1970), pp. 145-155.



Photo credit: U.S. Geological Survey

A surface plume of turbidity is produced when a dredge discharges material overboard. The extent, duration, and negative impacts of such a plume depend on the size and composition of the rejected material. Larger particles will settle out quickly and the plume will rapidly disperse. Very fine sediments may remain suspended for several days.

changes in seasonal and spatial patterns of organisms.⁸ Eggs and larvae in the mining area will be unable to escape. Most adult fish—the prime commercial species in the water column—are active swimmers and would be able to avoid the area of high particulate concentrations. Nonetheless, a large-scale, long-term mining operation will produce a ‘curtain’ of turbidity (cloudiness due to particulate) in the water column which might interfere with normal spawning habits, alter migration patterns, or cause fish to avoid the mining area altogether.

Heavy metals, e.g., copper, zinc, manganese, cadmium, and iron, may be released into the water column in biologically significant forms from some mining operations. The quantities of dissolved metals generally will be quite low, but current hypotheses suggest that small spatial and temporal differences in metal concentrations regulate the kinds of plankton found^{9,10}. Metals could, therefore, cause changes in species composition; such changes have been verified for copper both in the laboratory¹¹ and at sea.¹² Trace metals may be as important as macronutrients (nitrogen, phosphorus, and silicon) in controlling species composition and productivity in the marine environment. If so, then any large-scale disruptions in the natural metal balance due to mining activities could alter marine food webs. However, our understanding of the role of metals in unpolluted marine environments is currently constrained by the difficulty of measuring such minute quantities.

⁸A. Shar and H.F. Mulligan, “Simulated Seasonal Mining Impacts on Plankton, *International Revue Gesamte Hydrobiologie*, 62(4) 1977, pp. 505-510.

⁹A. Huntsman and W. G. Sunda, “The Role of Trace Metals in Regulating Phytoplankton Growth with Emphasis on Fe, Mn, and Cu,” *The Physiological Ecology of Phytoplankton*, I. Morris (ed.) (Boston: Blackwell Scientific Publications, 1981), pp. 285-328.

¹⁰F. A. Cross and W. G. Sunda, “The Relationship Between Chemical Speciation and Bioavailability of Trace Metals to Marine Organisms—A Review, *Proceedings of the International Symposium on Utilization of Coastal Ecosystems: Planning, Pollution, and Productivity*, Nov. 21-27, 1982 (Rio Grande, Brazil: 1985).

¹¹W. H. Thomas and D. L. R. Siebert, “Effect of Copper on the Dominance and the Diversity of Algae: Controlled Ecosystem Pollution Experiment, *Bulletin of Marine Science*, No. 27 (1977), pp. 23-33.

¹²W. G. Sunda, R. T. Barber, and S. A. Huntsman, “Phytoplankton Growth in Nutrient-Rich Seawater: Importance of Copper-Manganese Cellular Interactions,” *Journal of Marine Research*, No. 39 (1981), pp. 567-586.

Benthic Impacts

Little is known about the dynamics of animal communities on the seafloor. There are, however, several possible effects of concern. Animals within the mined area will be destroyed. Large-scale removal of bottom sediments will alter the topography and therefore could affect currents and substrate characteristics, which in turn affect species composition.¹³ Benthic plumes from mining devices will cause sedimentation on the bottom-dwelling organisms and eggs in the vicinity. Surface plumes from rejection of some of the mined material will eventually settle over a much wider area and cover animals with a thin layer of sediment. Silt deposits can smother benthic organisms and inhibit growth and development of juvenile stages.^{14,19} While the first new colonizing organisms in a mined area probably will be those with the highest dispersal, the direction of succession and final composition of the community is difficult to predict and is likely to be affected by grain size and suitability of the deposited sediment for colonization by benthic invertebrates.

The areas affected by mining will tend to be smaller than those affected by commercial fishing (especially bottom-trawling operations), which also removes large numbers of organisms and may disturb large sections of the seafloor. However, marine mining impacts may be more intense than those of fisheries.

¹³J. S. Gray, “Animal-Sediment Relationships, in *Oceanography and Marine Biology—An Annual Review*, H. Barnes (ed.), No. 12 (1974), pp. 223-262.

¹⁴W. B. Wilson, “The Effects of Sedimentation Due to Dredging Operations on Oysters in Copano Bay, Texas” (M.S. thesis, Texas A&M University, 1956).

¹⁵R. S. Scheltema, “Metamorphosis of the Veliger Larvae of *Nassarius obsoletus* (Gastropod) in Response to Bottom Sediment, *Biological Bulletin*, No. 120 (1961), pp. 92-109.

¹⁶G. Thorson, “Some Factors Influencing the Recruitment and Establishment of Marine Benthic Communities, *Netherlands Journal of Sea Research*, No. 3 (1966), pp. 267-293.

¹⁷Grigg and Kiwala, ‘Some Ecological Effects of Discharged Wastes on Marine Life.

¹⁸S. B. Saila, S. D. Pratt, and T. T. Polgar, *Dredge Spoil Disposal in Rhode Island Sound*, University of Rhode Island Marine Technical Report No. 2, 1972.

¹⁹P. S. Meadows and J. I. Campbell, “Habitat Selection by Aquatic Invertebrates, *Advances in Marine Biology*, No. 10 (1972), pp. 271-382.

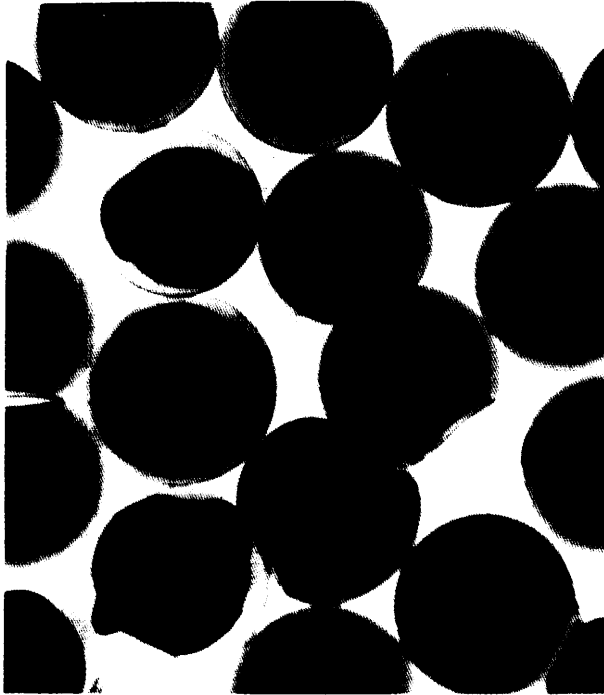

Photo credit" A Crosby Longwell, National Marine Fisheries Service

Atlantic mackerel eggs sorted out of plankton from surface waters of the New York Bight.

Alteration of Wave Patterns

Mining in shallow water may change the form and physiography of the seafloor. Wave patterns may be altered as a result of removing offshore bars or shoals or digging deep pits. When changes in wave patterns and wave forces affect the shoreline, coastal beaches can erode and structures can be damaged. The best example of these dangers occurred in the United Kingdom in the early 1900s when the town of Hallsands in Devon was severely damaged by wave action following large scale removal of offshore sandbars to build the Plymouth breakwater (see photograph). Coastal erosion is now the first consideration in the United Kingdom before mining takes place; dredging is limited to areas deeper than 60 feet. This criterion is based on studies that imply sediment transport is unlikely at depths greater than 45 feet; the additional 15 feet were added as an extra precaution.²⁰ Current work

²⁰R. w. Drinnan and D.G. Bliss, *The U.K. Experience on the Effects of Offshore Sand and Gravel Extraction on Coastal Erosion and the Fishing Industry*, Nova Scotia Department of Mines and Energy, Open File Report 86-054.

by the U.S. Army Corps of Engineers suggests that concern with water depth alone may not be sufficient to avoid beach erosion^{21,22} and that detailed on-site modeling should be considered in pre-planning analysis. For example, the U.S. Army Corps of Engineers of the New Orleans District built a beach and dune on Grand Isle, Louisiana for erosion control in 1983. The project required 2.8 million cubic yards of sand obtained by digging two large borrow holes one-half mile offshore (about twice this amount was actually dredged to achieve the design section). Shortly after completion, cusped sand bars began to form on the leeward side of the dredged holes and the beach began to erode adjacent to the newly formed bars. During the winter and spring of 1985, heavy storms exacerbated the areas of beach loss adjacent to the cusped bars (e.g., see opposite page).²³ This unexpected response of beach formation and erosion as a result of altered wave patterns around the borrow areas illustrates the importance of site-specific assessment before mining large volumes of sediment from the seafloor.

Seasonal

During certain times of the year, e.g., when eggs and larvae are abundant, the effects of offshore mining may have a more negative impact on the ocean community than at other times. Juvenile stages of fish and shellfish are transported by water currents and therefore are less able to actively avoid adverse conditions. They are generally more susceptible to high concentrations of suspended sediments than swimming organisms that can avoid such conditions. For example, striped bass larvae in the Chesapeake Bay develop more slowly when particulate levels are high.²⁴ Therefore, restricting offshore mining

²¹Dan Pope, U. S. Army Corps of Engineers, OTA Workshop on Environmental Concerns, Washington, D. C., Oct. 29, 1986.

²²R. J. Hallermeier, *A Profile Zonation for Seasonal Sand Beaches from Wave Climate*, U.S. Army Corps of Engineers, Reprint 81-3 (Fort Belvoir, VA: Coastal Engineering Research Center, April 1981).

²³A. J. Combe and C. W. Soileau, "Behavior of Man-made Beach and Dune, Grand Isle, Louisiana," *Coastal Sediment '87, 1987*, p. 1232.

²⁴A. H. Auld and J. R. Schubel, "Effects of Suspended Sediment on Fish Eggs and Larvae: A Laboratory Assessment," *Estuarine and Coastal Marine Science*, No. 6 (1978), pp. 153-164.

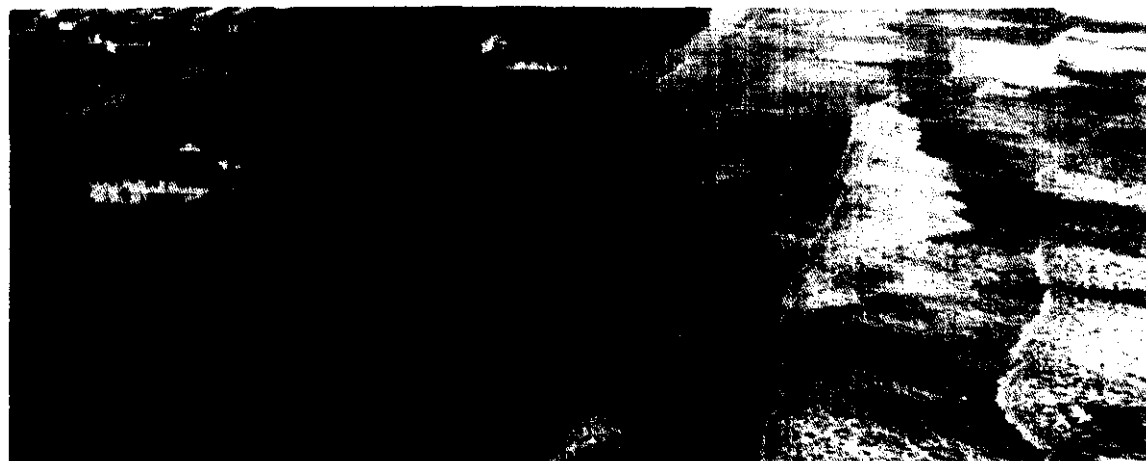

Photo credit: Jay Combe, US Army Corps of Engineers⁵

The U.S. Army Corps of Engineers of the New Orleans District built a beach and dune on Grand Isle, Louisiana for beach erosion control, recreation, and hurricane wave damage protection (Aug. 14, 1984).



The two offshore borrow areas from which the sand was obtained, were of sufficient width, depth, and proximity to the shore to modify wave climate. Over the next 3 years, cusped sand bars formed in the lee of the borrow pits while erosion occurred adjacent to these bars (Aug. 9, 1985).



A series of hurricanes between 1984-85 severely eroded areas immediately adjacent to and between the cusped bars destroying total beach and dune fill over one-seventh of the project length (Oct. 28, 1985). Plans to restore and modify the project to improve its resistance to damage in future hurricanes are essentially complete.

seasonally as environmental concerns warrant may protect biota during sensitive stages of development.

Permanently changing the topography of the seafloor may disrupt the spawning patterns of some

marine species dependent on a particular substrate type (e. g., salmon and herring).²⁵

²⁵S.J. de Groot, "The Potential Environmental Impact of Marine Gravel Extraction in the North Sea," *Ocean Management*, No. 5 (1979), pp. 233-249.

DIFFERENT EFFECTS IN SHALLOW AND DEEP WATER

While the potential environmental impacts of mining operations in shallow water are similar to those in deep water, the effects may be more obvious in shallow areas and may have a more direct effect on human activities. Many of the organisms on the continental shelf and in coastal waters are linked to humans through the food chain; decreased animal productivity may have an adverse economic effect as well as an undesirable environmental effect in these nearshore areas (see figure 6-2).

Surface Effects

Surface plumes are of more concern in nearshore shallow water areas than they are in deeper areas. In the open ocean, plankton productivity is lower and populations extend over huge geographic scales. The effects of a localized mining operation on the surface biota, therefore, will be less in the offshore situation. Visual and aesthetic effects from mining operations and waste plumes also will be less apparent far offshore.

Water Column Effects

High metal concentrations can reduce the rate of primary production by phytoplankton and can alter species composition and succession of phytoplankton communities.²⁶ Several factors act simultaneously to reduce the likelihood of adverse effects from metals released during mining operations in shallow water. Water over the continental shelf contains higher concentrations of particulate matter (and organic chelating agents) which convert the dissolved (ionic) metals into insoluble forms that are unavailable to plankton.²⁷ While no studies have yet identified metal contamination of the water column to be a serious consequence of seabed min-

ing, the potential for metal persistence is greater in the deep-sea.

Benthic Effects

Coastal waters are subject to continual wave action and seasonal changes, and the species found here are adapted to such conditions. The fine particulates stirred by mining operations may be similar to sediment resuspended by strong wave action in shallow water. In coastal areas, surface-living forms have been found to tolerate 2 inches of sediment deposition, sediment-dwelling animals (infauna) 10 to 12 inches, and deeper burrowing bivalves 4 to 20 inches.²⁸ On the other hand, animals accustomed to the relatively quiescent deep ocean environment may be less resilient to disruption of their habitat or blanketing by particulates. Since deep-sea animals live in an environment where natural sedimentation rates are on the order of millimeters per thousand years, they are assumed to have only very limited burrowing abilities. Thus, even a thin layer of sediment may kill these organisms. *g In general, if the resident fauna on an area of the shallow seafloor are buried, the community will generally recover more quickly than in the deep-sea.

Populations of animals directly within the mining path will be destroyed. Dredged areas in shallow seafloor are buried, the community will recover more quickly than in the deep-sea.

²⁸Consolidated Gold Fields Australia Ltd. and ARC Marine Ltd., *Marine Aggregate Project, Environmental Impact Statement*, vol. 1, February 1980.

²⁹P. A. Jumars and E.D. Gallagher, "Deep-Sea Community Structure: Three Plays on the Benthic Proscenium, The Environment of the Deep Sea, *Rubey Volume II*, W.G. Ernst and J.G. Morin (eds.) (Englewood Cliffs, NJ: 1982); and P.A. Jumars, "Limits in Predicting and Detecting Benthic Community Responses to Manganese Nodule Mining," *Marine Mining*, vol 3. (1981), No. 1/2, pp. 213-229.

²⁶Thomas and Siebert, "Effect of Copper. "

²⁷Huntsman and Sunda, "The Role of Trace Metals. "



Photo credit: Paul Rodhouse, British Antarctic Survey

Mussels, like many benthic marine organisms, filter their food. Sediments discharged from dredging vessels or stirred up by mining activities may clog feeding and respiratory surfaces of these animals or completely bury populations.

cies.³¹ Animal populations in fine-grained sediments appear to recover more rapidly than those in coarse-grained sediments, which may require up to 3 years for recovery.³² Recolonization rates in the deep sea are not known with any certainty, but they appear to be long—on the order of years—in areas not subject to periodic disturbance.^{33,36} Deep-sea benthic communities are areas of high species diversity, few individuals, slow recolonization rates, and questionable resilience. Shallow water benthic communities may have either high or low diversity, usually with large numbers of individuals, fast recolonization, and resilience to physical disturbance.

³⁰R. T. Saucier et al., *Executive Overview and Detailed Summary*, Technical Report prepared for U.S. Army Corps of Engineers Office, Chief of Engineers, Washington, D. C., December 1978.

³¹D. Thistle, "Natural Physical Disturbances and Communities of Marine Soft Bottoms, *Marine Ecology Progress Series*, No. 6 (1981), pp. 223-228.

³²Saucier et al., p. 75.

³³F. N. Spiess et al., *Environmental Effects of Deep Sea Dredging*, Report to National Oceanic and Atmospheric Administration, November 1986.

³⁴C. R. Smith, "Food for the Deep Sea: Utilization, Dispersal, and Flux of Nekton Falls at the Santa Catalina Basin Floor," *Deep-Sea Research*, vol. 32, No. 4.

³⁵J. F. Grassle, "Slow Recolonization of Deep-Sea Sediment," *Nature*, No. 265 (1977), pp. 618-619.

³⁶J. F. Grassle, "Diversity and Population Dynamics of Benthic Organisms," *Oceanus*, No. 21 (1978), pp. 42-45.

SHALLOW WATER MINING EXPERIENCE

Since little mining has taken place offshore of the United States³⁷, any discussion of the environmental impacts must rely heavily on the European experience. This experience is summarized in the documents of the International Council for the Exploration of the Seas (ICES—see box 6-A). Additionally, the very extensive experience of U.S. Army Corps of Engineers in lifting, redepositing,

³⁷There is currently sand and gravel mining in the Ambrose Channel of New York Harbor and a gold mining operation off Nome, Alaska, (see Ch. 5).

and monitoring sediments from dredging operations provides insights into the effects of shallow water mining. In particular, the 5-year Dredged Material Research Program (DMRP) (see box 6-B) attempted to cover all types of environmental settings offshore. The information gathered is relevant to the activities involved in mining sand and gravel or placer deposits. Finally, there are two regional efforts—The New England Offshore Mining Environmental Study (NOMES) (see box 6-C), and Sea Grant studies in New York Harbor

Box 6-A.—ICES—International Council for Exploration of the Sea

The International Council for Exploration of the Sea was set up in the mid-1970s primarily because of concerns over the environmental effects of sand and gravel mining in the North Sea. Three reports were issued in 1975, 1976, and 1979. Each report described the current mining operations country by country, as well as the environmental impacts avoided/encountered. The countries participating are the United Kingdom, Netherlands, Denmark, Federal Republic of Germany, France, Sweden, Norway, Ireland, United States, Belgium, and Finland. Based on the accumulated experience, a series of recommendations were drawn up and set out in the second *Report of the ICES Working Group on Effects on Fisheries of Marine Sand and Gravel Extraction*:

Member countries should collect and submit maps for all areas of potential dredging activity showing:

- a). the distribution of different types of sediment, bathymetry, etc.
- b). relevant fishing grounds, spawning areas, nursery areas, etc.

Additionally, more research on biological, chemical and physical effects was encouraged and the need for an environmental impact statement before prospecting or licensing was highlighted.

The three ICES reports conclude that the method selected for sand and gravel mining determines the direct and indirect impacts to bottom fauna and the final condition of the seabed. There are three alternative mining methods:

1. Extraction in a restricted area, deep into the seabed, with a stationary hopper dredger; the result will be a deep hole (as much as 230 feet) in the bottom. Such pits will not normally be backfilled with sediment.
2. Extraction over a wide area with trailing hopper dredgers; this will result in only removal of the top 8 inches.
3. Extraction over a relatively large area with stationary seaworthy dredging equipment; the sea bottom is lowered over the area by about 33-50 feet.

For sand dredging off the Netherlands coast, where sand is found in thick layers, a shallow lowering of the sea bottom over a wide area is preferred¹. Bottom composition and structure both before and after dredging remain similar. Although there would be destruction of the bottom fauna throughout the area mined, such effects are likely to be temporary. The recovery of the flora and the fauna should occur quickly because the colonizing substrate is unchanged.

If deep excavation is used in water depths greater than 50 feet, the pits will generally not backfill with sand because little transport takes place at these depths. An example of the impacts associated with deep excavation mining exists near the U.K. coast off Hastings, where gravel mining produced a pockmarked landscape in a previously good trawling area; here, bottom-trawling gear can no longer be used.²

From the many studies on the effects of marine aggregate dredging, it is evident that initial impacts can vary from minimal to severe and that disruptions range from short to long term. The sensitivity of the area involved determines the impact.

Belgium has adopted the ICES protocol and has designated all of its continental shelf as belonging to one of four zones that control the exploitation and extraction of sand offshore:

- **Zone 1:** Navigation areas. Extraction prohibited.
- **Zone 2:** Fishing Grounds. In view of their importance as spawning and nursery areas, this zone is prohibited for exploitation and extraction.
- **Zone 3:** Southern part of the Belgian continental shelf. Mining allowed when ecological monitoring is carried out.
- **Zone 4:** Northern part of the Belgian continental shelf. Extraction allowed after preliminary monitoring, with continuous ecological monitoring during extraction.

Canada is in the process of developing regulations for offshore mining and is considering similar designations.

¹International Council for the Exploration of the Sea, Marine Environment Quality Committee, *Report of the ICES Working Group on Effects on Fisheries of Marine Sand and Gravel Extraction*, Copenhagen, Denmark, 1979, p. 10.

²J.J. de Groot, "An Assessment of the Potential Environmental Impact of Longshore Sand Dredging by the Building of Artificial Islands in the North Sea," *Ocean Management*, No. 5 (1979), pp. 211-252.

³David Pasho, Canada Oil and Gas Lands Administration, OTA Workshop on Environmental Concerns, Washington, D.C., Oct. 29, 1986.

Box 6-B.—U.S. Army Corps of Engineers

The U.S. Army Corps of Engineers (COE) maintains over 25,000 miles of navigable waterways that service over 155 commercial ports and more than 400 small boat harbors. About 465 million cubic yards of sediment are dredged each year in the United States; most of this dredging is the result of COE projects that have been approved by Congress. About 30 percent of the material is disposed of in marine environments. The major program addressing environmental effects of dredging and disposal conducted by the U.S. Army Corps of Engineers is the Dredged Material Research Program (DMRP). This work was initiated following congressional authorization for a comprehensive nationwide research program.¹

The 5-year DMRP Program was completed in 1978 at a cost of approximately \$33 million; about 300 reports were produced as a result of this research effort. The project was designed to be applicable nationally with all regions and environmental settings represented. The overall conclusion of the study was that physical effects (such as smothering benthic communities) caused by dumping dredged material were more important than chemical or biological effects. However, these effects were deemed avoidable under guidance for the Section 404² and Section 103³ programs. In general, deep ocean areas were recommended as "more environmentally acceptable" for disposal than highly productive continental shelf areas. Except in unusually sensitive environments (such as coral reefs) or at critical stages in the life cycle of animals (spawning, larval development, and migration), turbidity plumes are "primarily a matter of aesthetic impact rather than biological impact." Benthic communities appear to recover if the grain-size of the sediment remains similar to the original condition after dredging or disposal occurs. Recolonization both of dredged areas and disposal mounds appears rapid for fine-grained sediments (silt) but requires up to 3 years for coarse-grained sediments (sand).

Short-term impacts from dredging and dredge disposal are brief and not of major environmental significance. Long-term monitoring studies still need to be done. In particular, chronic or sub-lethal effects of very long-term mining operations are not known.

¹Public Law 91-611.

²Public Law 92-500, The Federal Water Pollution Control Act, 1972.

³Public Law 95-532, The Marine Protection, Research, and Sanctuaries Act of 1972.

(see box 6-D) that examined naturally occurring organisms into organism tissues have been rare. The con- populations of organisms on the seafloor inclusion of the Dredged Material Research Program northeastern United States where shallow (DMRP) is that *biological conditions of most shallow mining operations are likely to take place. Glaciated areas—areas of high wave action— lines have been established by EPA and the Corps of Engineers (see box 6-E) for testing the impact of dumping dredged material which may, in some cases, provide information about effects of concern to the Corps of Engineer's finding, that in shallow water, there is much natural variation in both the distribution and abundance of species on the un- altered seafloor; these latter studies conclude that the most part, unfounded. Generally, only minimal chemical and biological impacts from dredging and disposal have been observed over the short-term³⁸. Most organisms studied were relatively insensitive to the effects of sediment suspensions or turbidity. Release of heavy metals and their*

appear to be influenced to a much greater extent by natural variation in the physical and chemical environment than they are by dredging or drilling. The NOMES and Sea Grant studies corroborate the Corps of Engineer's finding, that in shallow water, there is much natural variation in both the distribution and abundance of species on the un- altered seafloor; these latter studies conclude that *It is impossible to generalize about the effects of mining on all shallow water environments given the tremendous variability from site to site.* This conclusion suggests that, if a mined area is compared with an unmined area, changes due to the dredging or mining might not be statistically detectable because either:

³⁸R. A. Geyer (ed.), *Marine Environmental Pollution, Dumping and Mining*, Elsevier Oceanography Series 27B (Amsterdam-Oxford, New York: Elsevier Science Publishing Co., 1981).

- the mining really had a minimal impact, or
- the tremendous variability between sites masked the changes that occurred at the mining site.

[Page Omitted]

This page was originally printed on a gray background.
The scanned version of the page is almost entirely black and is unusable.
It has been intentionally omitted.
If a replacement page image of higher quality
becomes available, it will be posted
within the copy of this report
found on one of the OTA [websites](#).

FIG. 6-3.—New York Harbor Studies

The dense studies of the Lower Bay of New York Harbor showed the NOMES conclusion of benthic heterogeneity was correct. The majority of the studies that had been done on the biology of the benthos in this confined area, the Lower Bay (1957-1967) and the 100 stations were sampled for macrobiota using grab samplers. Methods of sampling were varied, but all used a period of 1 year (February 1966 to January 1967) off the southeast coast of Long Island. The University of Maryland Laboratory sampled 78 stations seasonally (1973 only) between Raritan Bay and the western part of the Raritan River.⁴¹ The New York District of the U.S. Army Corps of Engineers sampled the Long Island Sound and Raritan Channel before and after sand borrow dredging operations.⁴² Additionally, grab samplers were used in Raritan Bay and Raritan Bay were sampled once to estimate standing stock and diversity.⁴³ A table comparing the results of all five surveys, while not formally comparing methods of methodology or results of the surveys, clearly shows the data sets have little in common. Reasons for this conclusion: The wide variety of sampling devices, sampling frequency, and sediment type; the paucity of stations; and the inherent temporal and spatial patchiness of benthos make such a comparison of little value.

In the Raritan Bay, muddy bottoms composed of silt and clay and sandy bottoms had markedly different biological communities.⁴⁴ They showed only small differences between them. While both sediment types were low in both density and diversity, the sandy bottom was more diverse, with only 10 species being reported. However, the Lower Bay has been described by a number of authors as having conditions which may contribute to decreased biological activity.⁴⁵ The East River has been described as "far from depauperate."⁴⁶ This study identified a third unique community within a relatively small area of the Raritan Bay. Differences in benthos between dredged and undredged sites in the Lower New York Bay were less than differences from one geographic site to the next.⁴⁷

⁴¹U.S. Army Corps of Engineers, *Environmental Effects of Sand and Gravel Mining in the Lower Bay of New York Harbor*, Special Report 15, Reference 78-3, State University of New York, Marine Science Research Center, Stony Brook, NY, December 1978.

⁴²U.S. Army Corps of Engineers, *Environmental Effects of Sand and Gravel Mining in the Lower Bay of New York Harbor*, Reference 78-3, State University of New York, Marine Science Research Center, Stony Brook, NY, December 1978.

⁴³F. DeSisto and R. E. Stoeckl, "Abundance and Distribution of Benthic Macrofauna of the Eastern Long Island, New York." NOAA Technical Report NMFS, 1979, 1979.

⁴⁴J. A. Wilford, "Status of Benthic Macrofauna of Raritan Bay, New York, Harbor, Raritan Bay, and Raritan Channel." Proceedings, Third Symposium on Marine Mine Dredging, pages 71-72, 1975, State University of New York, Marine Science Research Center, Stony Brook, NY.

⁴⁵W. B. Clark, "The Raritan Bay, New York Harbor, and Raritan Channel, New York: Marine Science Research Program, Offshore Borrow Area, Results of Phase I-Preconstruction Studies presented to the Subcommittee on the Raritan Bay, New York Harbor, U.S. Army Corps of Engineers, 1975.

⁴⁶J. A. Wilford, *Review of Aquatic Resources and Hydrographic Characteristics of Raritan, Lower, and Sandy Hook Bays*, report prepared for the New York State Department of Environmental Conservation, Albany, NY, 1971.

⁴⁷McGee, "Benthic Macrofaunal Census."

⁴⁸Kasten et al., *Environmental Effects of Sand Mining*.

⁴⁹B. H. Rinckhuys, *Biological Effects of Sand and Gravel Mining in the Lower Bay of New York Harbor: An Assessment from the Literature*, State University of New York, Marine Science Research Center, Stony Brook, NY, January 1980.

⁵⁰Kasten et al., *Environmental Effects of Sand Mining*.

⁵¹Rinckhuys, *Biological Effects of Sand and Gravel Mining*.

column appears to cause only local and minor reductions in plankton productivity. The abundance and types of species found on the bottom also change.⁴¹ When the substrate type is changed due to the dredging activities (e. g., removal of gravel or a sand layer on top of 'bed-rock) then adverse effects may be persistent.⁴² The benthic commu-

nities that are established in the area after removing the top layers may differ significantly from the prior communities.⁴³

Of great concern to the European community is the potential detrimental effects of mining on commercial fisheries. Removal of gravel in herring

⁴¹S. J. de Groot, *Bibliography of Literature Dealing with the Effects of Marine Sand and Gravel Extraction on Fisheries* (The Netherlands: International Council for the Exploration of the Sea, Marine Environmental Quality Committee, 1981); de Groot, "The Potential Environmental Impact of Marine Gravel Extraction in the North Sea."

⁴²International Council for the Exploration of the Sea, *Second Report of the ICES Working Group on Effects on Fisheries of Marine Sand and Gravel Extraction*, Cooperative Research Report No. 64,

(Charlottenlund, Denmark: ICES, April 1977); International Council for the Exploration of the Sea, Marine Environmental Quality Committee, *Report of the ZCES Working Group on Effects on Fisheries of Marine Sand and Gravel Extraction*, (Charlottenlund, Denmark: ICES, 1979).

⁴³A. P. Cressard and C. P. Augris, "French Shelf Sand and Gravel Regulations," *Proceedings of the Offshore Technology Conference*, OTC 4292, 1982.

Box 6-3.—EPA/CSE Criteria for Dredged and DE Material

Section 103 of the Marine Protection, Research, and Conservation Act of 1972 (Public Law 92-532) specifies that any proposed operation involving the transportation and disposal of dredged material into ocean waters must be evaluated for potential environmental impact. The regulations start with the Secretary of the Army and the Administrator of the Environmental Protection Agency, in a joint proceeding with the District Engineer and Regional Administrator. Environmental procedures must follow criteria published by EPA in the Federal Register, vol. 42, No. 7, January 17, 1977. The general goal of planning and final decisions are emphasized as tools for minimizing the potential for environmental impact.

It is possible that offshore sand and gravel extraction, placer mining, and phosphate extraction will be excluded from detailed biological assessment and monitoring under the 1977 CMAA. Dredged material that does not meet these standards must be stored in a designated disposal area. The procedure requires biological criteria to be established for dredged material and to be broken into three components for evaluation: (1) toxic substances, (2) physical characteristics, and (3) solid phase. The greatest potential disturbance to the benthic community is caused by the solid phase. For each phase, three species must be used in assessing toxicity of the material.

The Register required that a technical implementation manual be developed jointly by EPA and the Corps of Engineers (COE). The manual contains summaries and discussions of the procedures for biological evaluation of dredged material, how to implement them, definitions, sample collection and preservation procedures, evaluation procedures, calculations, interpretative guidance, and supporting references required for the evaluation of permit applications.

Dredged material (including the solids in bulk form) is assumed to be composed of sand, silt, gravel, shells, and debris. The material is assumed to be composed of sand, silt, gravel, shells, and debris. The material is assumed to be composed of sand, silt, gravel, shells, and debris. The material is assumed to be composed of sand, silt, gravel, shells, and debris.

The material is assumed to be composed of sand, silt, gravel, shells, and debris. The material is assumed to be composed of sand, silt, gravel, shells, and debris. The material is assumed to be composed of sand, silt, gravel, shells, and debris.

EPA/CSE Federal Register Criteria for Dredged and DE Material. Biological Evaluation of Proposed Discharge of Dredged Material into Ocean Waters. Implementing Manual for Section 103 of Public Law 92-532, July 1977. Special Planning Area 1574 (U.S. Army Engineer Waterways Experiment Station, Vicksburg, MS).

spawning areas or on sandbanks where sand eels hide at night adversely affects these fisheries⁴⁴. While direct negative effects of dredging on adult fish stocks has not been clearly demonstrated, these concerns remain. To protect fishing interests, ICES proposed a "Code of Practice."⁴⁵ Elements of this code have been adopted by France and the United Kingdom. The code requires that the exact boundaries of the mining area and the amount and thickness of the sediment layer to be removed be specified. In addition, the expected condition of the seabed after completion of dredging operations must be described, including the amount of gravel remaining to enable herring to spawn.

⁴⁴It is still not known why herring select a specific spawning ground or what the selection criteria are for sand eel (Ammodytes) in their choice of a specific bank in which to dig.

⁴⁵International Council for the Exploration of the Sea.

From the U.S. and European work discussed above, it appears that there are three ways to minimize the environmental effect of mining operations in near-shore areas, namely:

1. identify and avoid environmentally sensitive areas with regard to biota, spawning areas, migration, currents, coastline erosion, etc.;
2. where mining does occur, use dredging equipment that minimizes destruction of the bottom as well as production of both surface and bottom particulate benthic plumes; and
3. effectively restore the site to its original pre-mining condition—mine and "reclaim" the area by smoothing seafloor gouges and replacing removed sediment with a similar type and grain-size. (Note: While this option may be feasible in certain cases, it is expensive and energy-intensive. Because little information



Photo credit: Southern California Coastal Research Project Authority

Coastal regions are the most biologically productive areas of the ocean. Because offshore mining is most likely to occur here first, care must be taken to avoid areas important for fisheries.

exists on reclamation, this option will not be considered below.

Information from many existing environmental studies^{46,51} can be combined to characterize the

⁴⁶National Ocean Service, Office of Oceanography and Marine Assessment, Ocean Assessments Division, Strategic Assessments Branch, *Coastal and Ocean Zones, Strategic Assessment: Data Atlas*. The atlases consist of maps covering a range of topics on physical and biological environments (geology, surface temperatures, and aquatic vegetation); living marine resources (species of invertebrates, fishes, birds, and mammals); economic activities (population distribution and seafood production); environmental quality (oil and grease discharge); and jurisdictions (political boundaries and environmental quality management areas) The *Eastern United States Atlas* (125 maps) was published by the Department of Commerce in 1980; it is now out-of-print. The *Gulf of Mexico Atlas* (163 four-color maps) was printed by the U.S. Government Printing Office in 1985. The *Bering, Chukchi, and Beaufort Seas Atlas* (127 maps) will be printed early in 1987. The *West Coast and Gulf of Alaska Atlas* is scheduled for 1988 publication.

areas of prime ecological concern. Dredging and mining operations can then avoid prime fish and shellfish areas especially during times of reproduction and migration. The OTA Workshop on Environmental Concerns stressed that a compendium of such information should be developed; currently, there are many sources of data⁵² housed in different agencies or institutions, but it is difficult to compare or combine them.

Historically, the dredging industry has emphasized increasing production rather than reducing sediment in the water column or minimizing damage to the environment. Information on particulate levels and other effects caused by different dredge designs exists (see table 6-1). U.S. Army Corps of Engineers field studies indicate that the butterhead dredge produces most of its turbidity near the bottom, as does the hopper dredge with-

A national atlas of 20 maps on the health and use of coastal waters of the U.S. is also being produced by NOAA. The first five are: *Ocean Disposal Sites, Estuarine Systems, Oil Production, Dredging Activities*, and NOAA's *National Status and Trends Program*. Future maps are scheduled on hazardous waste sites, marine mammals, fisheries management areas, and other similar topics.

⁴⁷U.S. Department of the Interior, Fish and Wildlife Service *Biological Services Program: "Gulf Coast Ecological Inventory, User's Guide and Information Base,"* August 1982; "Pacific Coast Ecological Inventory, User's Guide and Information Base," October 1981; and "Atlantic Coast Ecological Inventory, User's Guide and Information Base," September 1980.

⁴⁸Marine Ecosystems Analysis Program (MESA), New York Bight Atlas Monograph Series, New York Bight Project, New York Sea Grant Institute, Albany, 1975, especially Monographs 13-15 ("Plankton Systematic and Distribution T. Malone, "Benthic Fauna by J.B. Pearce and D. Radosh, and "Fish Distribution" M.D. Grosslein and T.R. A. Zarovitz").

⁴⁹U.S. Department of the Interior, Minerals Management Service, "Proposed 5-Year Outer Continental Shelf Oil and Gas Leasing Program, Mid-1987 to Mid-1992," *Final Environmental Impact Statement*, Volumes I and II, January 1987. There are 22 planning areas for oil and gas development within the U.S. For each area, information has been collected on biological species, geologic and chemical conditions, physical oceanography, and socio-economic conditions. About \$400 million has gone into the Environmental Studies Program since 1973. Hundreds of papers and reports have been published as a result; these are listed and summarized in *Environmental Studies Index*, OCS Report 86-0020, U.S. Department of the Interior, Minerals Management Service, 1986.

⁵⁰B.L. Freeman and L.A. Walford, *Anglers' Guide to the United States Atlantic Coast, Fish, Fishing Grounds and Fishing Facilities*, prepared for the U.S. Department of Commerce, Seattle, WA, July 1976.

⁵¹Scripps Institution of Oceanography, *California Cooperative Oceanic Fisheries Investigations (CalCOFI)*, A-027. The distributions of species in the California Current Region are mapped in a 30-volume atlas series. This series is one of the few long-term monitoring studies of a large region; records are available from 1949 to the present day.

⁵²Besides the large studies cited here, there are many regional, state, and local studies.

Table 6-1.—Environmental Perturbations from Various Mining Systems

Mining method		Seabed				Water column			
Mining approaches	Mining systems	Fragmentation/ collection	Excavation	Turbidity plume	Resedimentation	Subsidence	Suspended particulate	Dissolved substances	
Scraping	Drag line dredge	•		•	•		•	•	
	Trailing cutter suction dredge	•		•*	•*		•*	•	
	Rock cutter section dredge	•		•	•		•	•	
	Crust-miner	•		•	•		•	•	
	Continuous line bucket	•		•	•		•	•	
	Clams shell bucket		•	•	•		•	•	
	Bucket ladder dredge		•	•	•		•	•	
	Bucket wheel dredge		•	•*	•*		•*	•	
	Excavating	Anchored suction dredge		•	•*	•*		•*	•
		Cutterhead suction dredge		•	•	•		•	•
Drilling and blasting			•*						
Tunneling beneath seafloor	Shore entry					•			
	Artificial island entry					•			
Fluidizing (sub-seafloor)	Slurrying					•			
	Leaching								

* Applicable or potentially applicable.

• Relative major perturbation.

SOURCE: *Environmental Effects Document* prepared by U.S. Department of the Interior Regulatory Task Force for Leasing of Minerals Other than Oil, Gas, and Sulphur In the Outer Continental Shelf, unpublished draft, October 1986.

out overflow. The bucket dredge and the hopper dredge with overflow, however, produce suspended sediments throughout the water column. The modified dustpan dredge appears to suspend more solids than a conventional butterhead dredge.⁵³

A typical bucket dredge operation produces a plume of particulate extending about 1,000 feet downcurrent at the surface and about 1,600 feet near the bottom.⁵⁴ In the immediate vicinity of the operation, the maximum concentration of sediment suspended at the surface should be less than 500 mg/l and should rapidly decrease with distance. Water column concentrations generally should be less than 100 mg/l.⁵⁵ When mining stops, the turbidity plume will settle rapidly.

The dispersion of a turbidity plume can be effectively altered by the configuration of the pipe-

line at the point of discharge (see figure 6-5).⁵⁶ Pipeline angles that minimize water column turbidity (e.g., with a 90-degree angle) produce mud mounds that are thick but cover a minimum area. Conversely, those that generate the greatest turbidity in the water column disperse widely and produce relatively thin mud mounds of maximum areal extent.⁵⁷

Many parameters, such as particle settling rates, discharge rate, water depth, current velocities, and the diffusion velocity, all interact to control the size and shape of the turbidity plume. As water current speed increases, the plume will grow longer. As the dredge size increases or particle settling rates decrease, the plume size will tend to increase.⁵⁸ Finally, with lower rates of dispersion or particle set-

⁵⁶J. R. Schubel et al., *Field Investigations of the Nature, Degree, and Extent of Turbidity Generated by Open Water Pipeline Disposal Operations*, U.S. Army Engineer Waterways Experiment Station, Technical Report, Vicksburg, MS, D-78-30, July 1978.

⁵⁷A general rule of thumb is that, as the height of the redeposited mound decreases by a factor of two, the areal coverage increases by a factor of two. But as the mound height decreases, the amount of wave-induced resuspension of the surface material will also decrease.

⁵⁸In addition, as the diffusion velocity increases for a given current velocity, the plume becomes longer and wider, while the solids concentrations in the plume decrease.

⁵³For more information on dredge designs, see Ch. 4.

⁵⁴W. D. Barnard, *Prediction and Control of Dredged Material Dispersion Around Dredging and Open Water Pipeline Disposal Operations*, U.S. Army Engineer Waterways Experiment Station, Vicksburg, MS, Technical Report DS-78-13, August 1978.

⁵⁵Sediment suspended by a dredge is similar to the amount of disturbance produced by a small-scale storm.

Figure 6-5.—The Effect of Discharge Angle and Water Current on the Shape and Depth of Redepleted Sediments

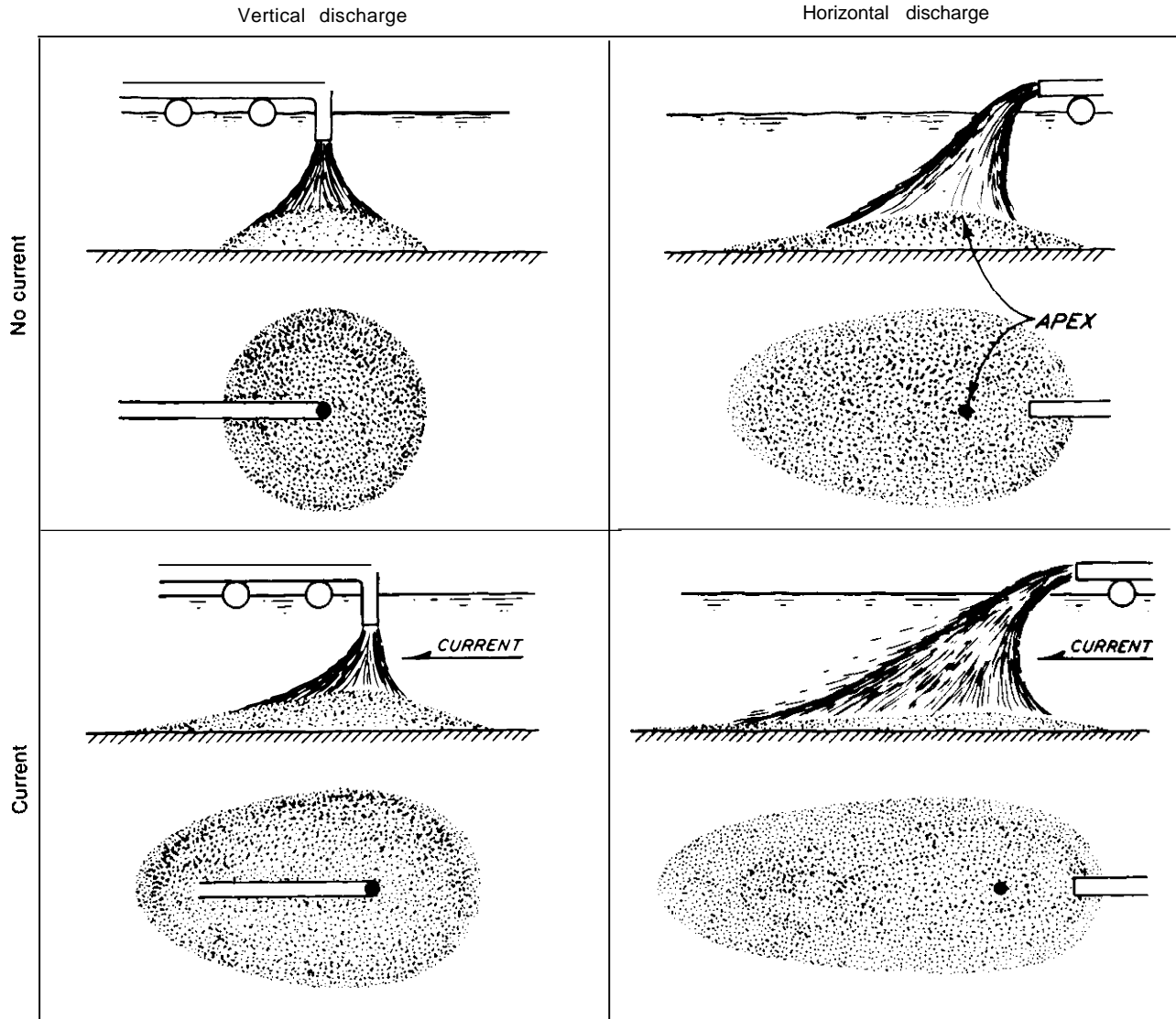

If mining ships discharge unwanted sediments through a vertical pipe (left portion of diagram) seafloor deposits will cover a smaller area but to a greater depth than if a horizontal discharge pipe is used (right side of diagram) which results in a large but thin "footprint" of sediments. The movement of water current (bottom of diagram) will similarly expand the area of the seafloor blanketed by sediment but decrease the depth of the deposit overall.

SOURCE: Modified from W. Barnard, "Prediction and Control of Dredged Material Dispersion Around Dredging and Open Water Pipeline Disposal Operations," U.S. Army Corps Engineer Waterways Experiment Station, Vicksburg, MS, Technical Report DS 7S-13, August 1979.

ting or an increase in water depth, the length of time required for the plume to dissipate after the disposal operation has ceased will increase.

One method for physically controlling the dispersion of turbid water is a "silt curtain." (see figure 6-6). A silt curtain is a turbidity barrier that

extends vertically from the water surface to a specified depth around the area of discharge. At present, silt curtains have limited usefulness; they are not recommended for "operations in the open ocean, in currents exceeding one knot, in areas frequently exposed to high winds and large breaking waves, or around hopper or butterhead dredges where fre-

Figure 6-6.—Silt Curtain

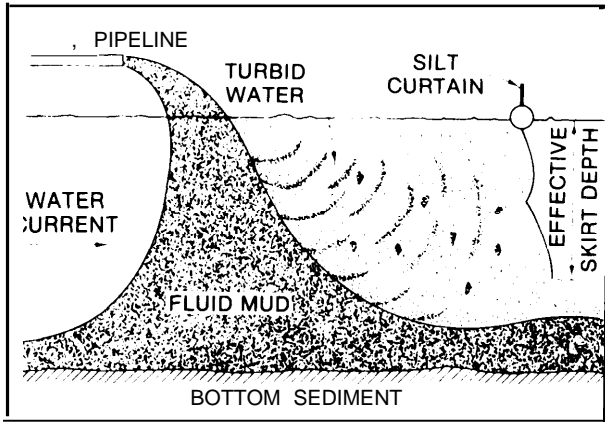

SOURCE: Modified from U.S. Army Corps of Engineers, "Executive Overview and Detailed Summary," Synthesis of Research Results, DMRP Program, U.S. Army Corps Engineer Waterways Experiment Station, Vicksburg, MS, Technical Report DS 78-22, December 1978.

quent curtain movement would be necessary.⁵⁹ Once environmental effects are better defined, engineering techniques can be developed to address them. For example, Japanese industry has developed a system that may reduce turbidity in the surface layers of the water column when sediment is discarded. Air bubbles entrained in the water during dredge filling and overflow exacerbate the surface turbidity plume associated with hydraulic hopper dredging. A system, called the "Anti-Turbidity Overflow System" employed by the Ishikawajima-Harima Heavy Industries Company, Ltd., (IHI) reportedly separates air from the water prior to overflow. According to IHI data, the result is a clear water column and, presumably, a smaller area of fine sediment at the dredge site caused by particles that settle rapidly.

⁵⁹Barnard, *Prediction and Control of Dredged Material Dispersion*, p. 87.

DEEP WATER MINING STUDIES

In the deep-sea, the abundance of animal life decreases with increasing depth and distance from land. Deep-sea animals are predominantly restricted to the surface of the seafloor and the upper few inches of the bottom. Species, especially smaller-sized organisms, are incompletely catalogued at present, and little information is available on their life cycles. The density of animals is low but diversity may be high. In these regions, the low total number of animals is thought to reflect the restricted food supply, which comes from either residues raining into the deep sea from above or from *in situ* production.⁶⁰

All estimates of the environmental impacts of deepsea mining draw heavily on information from the Deep Ocean Mining Environmental Study (DOMES), the only systematic long-term research program conducted in very deep water. Justification for extrapolating from these deep-sea sites to others rests on the hypothesis that, in general, the abyssal ocean is a much more homogeneous environment than shallow water environments.

DOMES: Deep Ocean Mining Environmental Study

DOMES was a comprehensive 5-year (1975-80) research program funded by NOAA. The goal was to develop an environmental database to satisfy the National Environmental Policy Act requirements to assess the potential environmental impacts of manganese nodule recovery operations.⁶¹ During the first phase of DOMES, the environmental conditions in the designated manganese nodule area of the Pacific Ocean (i. e., the DOMES area) were characterized to provide a background against which mining-produced perturbations could be later compared. These baseline studies were carried out at three sites that covered the range of environmental parameters expected to be encountered during mining (see box 6-F).

The mining scenario presumed removal of nodules from the deep seabed by means of a collector (up to 65 feet wide) pulled or driven along the seabed at about 2 miles per hour. Animals on the

⁶⁰ Deep-sea biomass often correlates with primary productivity above; areas beneath low productivity subtropical waters may be an order of magnitude lower in biomass per unit area than at high latitudes.

⁶¹U.S. Department of Commerce, NOAA Office of Ocean Minerals and Energy, *Deep Seabed Mining, Final Programmatic Environmental Impact Statement, vol. 1*, (Washington, D. C.: Department of Commerce, September 1981).

Box 6-F.—Deep Ocean Mining Environmental Study (DOMES)

The objectives of the first phase of the DOMES program were:

1. to establish environmental baselines at three sites chosen as representative of the range of selected environmental parameters likely to be encountered during nodule mining,
2. to begin to develop the capability to predict potential environmental effects of nodule mining, and
3. to contribute to the information base available to industry and government for development of appropriate environmental guidelines.

Field work associated with the studies included upper water layer measurements of currents, light penetration, and plant pigments and the primary productivity, abundance, and species composition of zooplankton and nekton. Temperature, salinity, suspended particulate matter, nutrients, and dissolved oxygen were measured throughout the water column. Current measurements were also made in the benthic boundary layer. Abundance and distribution of benthic populations and characteristics of the sediments and pore water were determined. In addition, the seasonal and spatial variability of chemical and biological parameters at four oceanographic depth zones were studied:

1. the surface mixed layer,
2. the pycnocline,
3. the bottom of the pycnocline to 1,300 feet, and
4. 1,300 to 3,300 feet—were characterized for future comparison with measurements made during actual mining activities.

The second phase of the DOMES project focused on refining predictive capabilities through analysis of data acquired during pilot-scale tests of mining systems. Two successful pilot-scale mining tests were monitored in 1978, one using both hydraulic and air-lift mining systems, and one using air-lift only. Each test saw hundreds of tons of manganese nodules brought from water depths of 13,000 to 16,400 feet to the surface. These tests established the engineering feasibility of deepsea mining, provided the first opportunity to observe actual effects of operations such as those envisioned for the next decade, and allowed comparisons of those effects with earlier estimates of mining perturbations. During these tests, discharge volumes, particulate concentrations, and temperature were measured from each mining vessel; limited studies were made of the surface and benthic plumes; and biological impact assessments were made. The second phase of DOMES consisted of monitoring actual pilot-scale mining simulation tests. Its objectives were:

- to observe actual environmental effects relevant to forecasting impacts, and
- to refine the database for guideline development.

SOURCE: U.S. Department of Commerce, NOAA, Office of Ocean Minerals and Energy Deep Seabed Mining, Final Programmatic Environmental Impact Statement, vol. 1, September 1981.

seafloor directly in the mining path or nearby would be disturbed by the collector and the subsequent sediment plume. In addition, when the nodules reached the mining ships, the remaining residue (consisting of bottom water, sediments, and nodule fragments) would be discharged over the side of the ship, resulting in a surface discharge plume that might also cause adverse impact.

The Final Programmatic Environmental Impact Statement concluded that of 20 to 30 possible negative impacts (see table 6-2) from deepsea mining, only 3 were of sufficient concern to be investigated as part of the 5-year research plan required by the 1980 Deep Seabed Hard Mineral Resources Act.⁶²

The first of the three important impacts occurs at the seabed. First, the collection equipment will probably destroy benthic biota, an impact which—as in the case of shallow water mining—appears to be both adverse and unavoidable. The degree of disturbance depends upon the kinds of equipment used and the intensity of mining. The affected biota include animals such as sea stars, brittle stars, sea urchins, sea cucumbers, polychaete worms, and sea anemones. NOAA did not identify any benthic endangered species in the area that may be affected by bottom disturbance. Most *benthic animals* in the DOMES area appear to be tiny detritus feeders that live in the upper centimeter of sediment and are fed by organic material that falls from upper waters. A worst-case estimate is that the ben-

⁶²Public Law 96-283.

Table 6-2.—Summary of Environmental Concerns and Potential Significant Impacts of Deep-Sea Mining

Disturbance Initial conditions	Physico-chemical effects	Potential biological impacts (remaining concerns in italics)	Potential significance of biological impact			
			Probability of occurrence	Recovery rate	Consequence	Overall significance
<i>collector</i>	• Scour and compact sediments	<i>Destroy benthic fauna in amount near collector track</i>	Certain	Unknown ^c	Adverse	Unavoidable* (uncertain significance)
	• Light and sound	Attraction to new food supply	Unlikely	Unknown (probably rapid)	Uncertain	None
<i>Benthic plume</i>	• Increased sedimentation rate and increased suspended matter ("rain of fines")	• <i>Effect on Benthos</i> —Covering of food supply	Likely	Unknown ^c (probably slow)	Adverse	Unknown ^b
		—Clogging of respiratory surfaces of filter feeders	Likely	Unknown ^c (probably slow)	Adverse	Unknown
		—Blanketing	Certain	Unknown ^c (probably slow)	Adverse	Unknown ^a
	• Nutrient/trace metal increase	• Increased food supply for benthos	Unlikely	Rapid ^d	Possibly beneficial	None
		Trace metals uptake by zooplankton	Unlikely	Rapid	No detectable	None
• Oxygen demand	• Lower dissolved oxygen for organisms to utilize; mortality from anaerobic conditions	Unlikely	Rapid	No detectable effect	None	
<i>Surface discharge</i> Particulate	• Increased suspended particulate matter	• Effect on zooplankton —Mortality	Unlikely	Rapid ^d	No detectable effect ^b	None
		—Change in abundance and/or species composition	Unlikely	Rapid ^d	No detectable effect ^a	None
		—Trace metal uptake	Unlikely	Rapid ^d	Locally adverse	Low*
		—Increased food supply due to introduction of benthic biotic debris and elevated microbial activity due to increased substrate	Unlikely	Rapid ^d	Possibly beneficial	None
	• Effect on adult fish	Unlikely	Rapid ^d	No detectable effect ^b	None	
		• <i>Effect on fish larvae</i>	Uncertain (low)	Uncertain (probably rapid)	Uncertain	Low*
	• Oxygen demand	• Low dissolved oxygen for organisms to use	Unlikely	Rapid	No detectable effect	None
		• Effect on primary productivity	Unlikely	Uncertain (probably rapid)	Unknown (probably undetectable)	Low
	• Decreased light due to increased turbidity	• Decrease in primary productivity	Certain	Rapid ^d	Locally adverse	Low
	<i>Surface discharge</i> Dissolved substances	• Increased nutrients	• Increase in primary productivity	Very low	Rapid ^d	No detectable effect ^a
• Change in phytoplankton species composition			Very low		No detectable effect ^a	None
• Increase in dissolved trace metals		• Inhibition of primary productivity	Very low	Rapid ^d	No detectable effect ^b	None
		• Embolism	Very low	Rapid	No detectable effect ^a	None
• Supersaturation in dissolved gas content						

^aIncludes characteristics of the discharge and the mining system.

^bBased on experiments/measurements conducted under DOMES.

^cYears to tens of years or longer.

^dDays to weeks.

Uncertain = Some knowledge exists; however the validity of extrapolations is tenuous.

Unknown = Very little or no knowledge exists on the subjects; predictions mostly based on conjecture.

• Areas of future research.

SPM = Suspended Particulate Matter.

SOURCE: Adapted from U.S. Department of Commerce, Office of Ocean Minerals and Energy, *Deep Seabed Mining, Final Programmatic Environmental Impact Statement*, vol. 1 (Washington, DC: September 1963), p. 126.

thic biota in about 1 percent of the DOMES area, or 38,000 square nautical miles, may be killed due to impacts from first generation mining activities. Although recolonization is likely to occur after mining, the time period required is not known. No effect on the water-column food chain is expected.

The second important type of impact identified is due to a benthic plume or "rain of fines" away from the collector which may affect seabed animals outside the actual mining tract through smothering and interference with feeding. Suspended sediment concentrations decrease rapidly, but the plume can extend tens of kilometers from the collector and last several weeks after mining stops. No effect on the food chain in the water column is expected due to the rapid dilution of the plume. However, mining may interfere with the food supply for the bottom-feeding animals and clog the respiratory surfaces of filter feeders (such as clams and mussels). Such effects will involve biota in an estimated 0.5 percent or 19,000 square nautical miles of the DOMES area.

The third impact identified as significant is due to the surface plume. Under the scenario, a 5,500-ton-per-day mining ship will discharge about 2,200 tons of solids (mainly seafloor sediment) and 3 million cubic feet of water per day. The resulting surface discharge plume may extend about 40 to 60 miles with a width of 12-20 miles and will continue to be detectable for three to four days following discharge. As the mining operation is supposedly continuous (300 days per year), the plume will be visible virtually all the time. Surface plumes may adversely affect the larvae of fish, such as tuna, which spawn in the open ocean. The turbidity in the water column will decrease light available for photosynthesis but will not severely affect the phytoplankton populations. The effect will be well within the realm of normal light level fluctuations and will resemble the light reduction on a cloudy day.

Follow-Up to DOMES:

Research by the National Marine Fisheries Service, under NOAA's five-year plan, concluded that the surface plume was not really a problem due to rapid dilution and dissipation. This study identified another potential adverse effect that previously

had not been considered—that of thermal shock to plankton and fish larvae from discharge at the surface of cold deep water.⁶³ However, except for mortality of some tuna and billfish larvae (the two commercially important fish) in the immediate vicinity of the cold water (4-100 C) discharge, adverse effects appear to be minimal.

Continued study of surface plumes suggests that discharged particulate will not accumulate on the pycnocline.⁶⁴ Because new measurements show much of the material discharged settled more slowly than previously thought, the plumes will cover more area.

In June 1983, Expedition ECHO I collected 15 quantitative samples of the benthic fauna in the vicinity of DOMES site C (150 N, 1250 W). These samples were collected for a study of potential impacts on the benthic community of a pilot-scale test mining by Ocean Mining Associates, carried out 5 years earlier. Fauna from the immediate test mining area were compared with fauna from an area

⁶³W.M. Matsumoto, *Potential Impact of Deep Seabed Mining on the Larvae of Tuna and Billfishes*, SWFC Honolulu Laboratory, National Marine Fisheries Service/NOAA, prepared for NOAA Division of Ocean Minerals and Energy, NOAA-TM-NMFS-SWFC-44, Washington, D. C., 1984.

⁶⁴J.W. Lavelle and E. Ozturgut, "Dispersion of Deep-Sea Mining Particulate and Their Effect on Light in Ocean Surface Layers," *Marine Mining*, vol. 3. (1982), No. 1/2, pp. 185-212.



Photo credit: National Oceanic and Atmospheric Administration

The box core sampler is a standard tool for studying ocean bottoms. This particular sample, containing manganese nodules, is from the DOMES area. Box cores provide a relatively intact picture of the sediment and animals in the top layers of the seafloor.

far enough away to have been undisturbed. Disturbance to the seafloor was either not extensive enough to produce a statistically detectable difference in community structure from unaltered areas, or recovery had taken place within 5 years.⁶⁵ Conclusions were that the test mining was not indicative of an actual mining operation. Future research will include some short-term (30-day) sedimentation studies to try to characterize the response time of benthic animals to plume effects.⁶⁶

Recommendations for future research include:

- studying a much larger mining effort or other similar impact on the benthos,
- sampling at the same sites previously sampled to develop trends over time, and
- evaluating data to detect differences at a community level, not at individual or species levels.

Environmental Effects From Mining Cobalt Crusts

The environmental baseline data that DOMES collected and the conclusions it drew about potential impacts of nodule mining are somewhat applicable to mining cobalt crusts. The environmental setting described from the DOMES area has much in common with proposed crust sites. DOMES stations span the central and north Pacific basins and are in areas meteorologically similar to the Hawaiian and Johnston Island EEZs. The environment studied was typical of the tropical and subtropical Pacific in terms of water masses, major currents, and vertical thermal structure. Species recorded in the water column of the DOMES area are all characterized as having broad oceanic distributions. The settings differ primarily with respect to topography and bottom type. The crusts occur on the slopes of seamounts with little loose sediment, while the nodule mine sites occur on plains carpeted with thick sediments. The two areas consequently differ in their potential for resuspension of sediments.

Baseline benthic biological data collected in the DOMES study area are less analogous to the crust sites than are the water column pelagic data. The

chief depth range of interest for crust mining is 2,500 to 8,000 feet. Bottom stations sampled in the DOMES area varied in depth from 14,000 to 17,000 feet. Communities would be different because of the substrate as well as the depth. The DOMES sites consist of soft sediments interspersed with hard manganese nodules; the crusts are hard rock surfaces with little sediment cover. The communities actually living on the manganese nodule hard surfaces may resemble the fauna on the crust pavement because the substrate composition is very similar.

Plume Effects

As part of the Manganese Crust EIS Project, mathematical models were constructed to simulate the behavior of surface and benthic discharges.⁶⁷ This effort was based upon extensive modeling of dredged material discharge dispersion conducted for the Army Corps of Engineers' Dredged Material Research Program.^{68,69}

Surface Plume.—The DOMES data indicate that a mining plume will increase suspended particulate matter in the water by a factor often. This would effectively halt photosynthesis about 65 feet closer to the surface of the water than normal.

The results of field measurements made during the DOMES program were extrapolated to commercial-scale discharges and it was estimated that the surface plume could reduce daily primary production by 50 percent in an area 11 miles by 1 mile and by 10 percent over an area as large as 34 miles by 3 miles. The shading effect will only persist until the bulk of the mining particulate settle, usually within a period of less than a day. Since it takes phytoplankton 2 to 3 days to adapt to a new light regime, the short-term shading effect of particulates is not likely to affect the light-adaptation char-

⁶⁷E.K. Noda & Associates and R.C.Y. Koh, "Fates and Transport Modeling of Discharges from Ocean Manganese Crust Mining," prepared for the Manganese Crust EIS Project, Research Corporation the University of Hawaii, Honolulu, HI, 1985.

⁶⁸B. H. Johnson, 1974, "Investigation of Mathematical Models for the Physical Fate Prediction of Dredged Material, U.S. Army Engineer Waterways Experiment Station, Vicksburg, MS, Hydraulics Laboratory, Technical Report D-74-1, March 1974.

⁶⁹M. G. Brandsma and D.J. Divoky, 1976, "Development of Models for Prediction of Short-term Fate of Dredged Material Discharged in the Estuarine Environment," Tetra Tech, Inc., Pasadena, CA, Contract Report D-76-5, May 1976.

⁶⁵Spieß et al., *Environmental Effects of Deep Sea Dredging*.

⁶⁶Ed Myers, NOAA, pers. comm. OTA Workshop on Environmental Concerns, October 1986.



Photo credit: Barbara Hecker, Lament-Doherty Geological Observatory

Brittle stars and corals, shown here at 2,000-foot water depth, are two common kinds of animals living on hard substrates in the deep sea.

acteristics of the phytoplankton. No other potential effects (including increased production due to nutrient enrichment or heavy metal toxicity) could be demonstrated.⁷⁰

Application of the DOMES conclusions to the crust mining scenario requires some modifications.

⁷⁰U.S. Department of Commerce, *Deep Seabed Mining, Final Programmatic Environmental Impact Statement*. Minerals Management Service, *Draft Environmental Statement: Proposed Marine Mineral Lease Sale in the Hawaiian Archipelago and Johnston Island Exclusive Economic Zone*, Honolulu, HI, (1987), p. 208.

The crust mining surface plume will contain more solids in less water than the nodule mining surface plume, but the crust particles are larger and settle out faster. Thus, the area of reduced primary productivity probably would be approximately 50 percent smaller than that predicted for the nodule scenario, a very short-term localized impact.⁷¹

Bottom Plume.—A bottom plume would be generated from the movement of the mining equip-

⁷¹U.S. Department of the Interior, p. 208.

ment on the bottom and, in an emergency, from release of materials in the lift pipe. Ten hours after suspension, most material will be redeposited within 65 feet of the miner track, but only 1 percent of the smallest particles will be redeposited after 100 hours. From the test mining data, the researchers calculated that about 90 percent of the resuspended material would be redeposited within 230 feet of the miner track, and the maximum redeposition thickness would be a little more than half an inch thick near the centerline of the track. 7.

The crust scenario envisions recovery of about two-thirds of the ore volume of the nodule scenario but assumes a much thinner range of overburden. Peak base-case crust miner redeposition thicknesses were about one-thousandth of an inch. 73 There is a highly significant difference between the two mining scenarios. The "worst case" scenario for crust mining, 74 would result in less than 1 percent of the maximum deposition in the nodule mining scenario.

From the DOMES baseline data (average of 16 macrofaunal individuals/ft²) and an assumed nodule mining scenario, Jumars⁷⁵ calculated that a nodule miner would directly destroy 100 billion individuals. In comparison, data from a case study done at Cross Seamount (see box 6-G) indicate that passage of the crust miner over 11 mi² per year would directly destroy from 100,000 to 10,000 macrofaunal organisms at 2,600 and 7,800 feet respectively. The DOMES and Cross Seamount databases differ in that infaunal organisms (those actually living within the sediments) were not sampled in the Cross Seamount reconnaissance. However, the crusts provide little sediment for organisms to inhabit. Nevertheless, it appears that the number of macrofaunal organisms destroyed in the crust mining scenario is orders of magnitude less (one-millionth to one ten-millionth) than in the nodule scenario. 76

⁷²J. W. Lavelle et al. "Dispersal and Resedimentation of the Benthic Plume from Deep-Sea Mining Operations: A Model with Calibrations," *Marine Mining*, vol. 3 (1982), No. 1/2, pp. 185-212.

⁷³US Department of the Interior, Minerals Management Service, p. 197.

⁷⁴Minerals at the shallowest depth and superimposition of surface and bottom plume footprints.

⁷⁵Jumars, "Limits in Predicting and Detecting Benthic Community Responses.

⁷⁶US Department of the Interior, Minerals Management Service, p. 240.

The severity of the impacts on populations in areas adjacent to the miner track would be determined by the intensity of the disturbance, i.e., proximity to the track, and the type of feeding behavior characteristic of the population. As in the case with shallow water mining, highly motile organisms such as fish, amphipods, and shrimp would be most able to avoid localized areas of high redeposition and turbidity. Once conditions become tolerable, these organisms could venture into the mined area to feed on the dead and damaged organisms.

The area mined may be invaded by opportunistic species with dispersal capabilities greater than those of the original resident species. Reestablishment of the original community has been postulated to take a very long time, perhaps decades or longer.

Temperature

Comparing the ambient surface water temperature in the lease areas with a temperature of 4 to 10 degrees C for the bottom water released at the surface, there is reason to believe that eggs and larvae coming into direct contact with the cold discharge water could be affected adversely; such effects should be limited to the area immediately beneath the ship's outfall. 77

To estimate the annual loss of tuna larvae and the impact of this loss on adult fish biomass, it was assumed that all tuna eggs and larvae coming into direct contact with the cold water discharge could die. At least 46,000 skipjack tuna and 15,000 yellowfin tuna could be lost annually due to thermal mortality. These values would be about four times larger if the mining ship acts as a fish aggregating device by concentrating tuna schools in the immediate vicinity.

The loss of adult fish biomass due to death of larvae would be a very small fraction (less than 1 percent) of the total annual harvest of these species in the central and eastern North Pacific. The crust mining scenario assumes a surface plume volume about 60 percent that of the nodule mining scenario, and the effects of thermal mortality of larval fish would be reduced proportionately.

⁷⁷Matsumoto, "Potential Impact of Deep Seabed Mining." Contact of larvae with cold water could cause the development of deformed larvae.

Box 6-G.—Cobalt Crust Case Study

As part of the present program to assess the environmental impacts of crust mining in the EEZs of Hawaii and Johnston Island, a representative area, Cross Seamount, located about 100 miles south of Oahu, Hawaii (at 19° 40' N, 158° 17' W), was selected for a comprehensive, biogeological reconnaissance. The study was conducted by the Hawaii Undersea Research Laboratory.

At depths where manganese-cobalt (Mn-Co) crusts were thickest (1,000 to 2,000 m), the biota is unusually sparse, suggesting that larvae may be selectively avoiding crust substrates. More research will be required to substantiate this hypothesis. The depauperate nature of the benthic fauna of Cross Seamount, if representative of other Hawaiian seamounts, suggests that environmental impacts of possible future mining of Mn-Co crusts in such environments would be negligible, at least in terms of benthic species populations.¹

In general, the fauna of Cross Seamount is patchy, low in diversity and only a few species of commercial importance were seen. At depths of 1,300 feet to about 3,300 feet the fauna were about an order of magnitude more abundant than the fauna from 3,300 to 13,500 feet. The density of organisms in the upper depth interval (less than 1,000 feet) was about 8 organisms/ft², approximately 3 times that in the second interval (1,300 to 1,650 feet). From 1,650 to 2,000 feet density declined markedly to about 1 organism/ft². Again, from 2,000 to 2,300 feet density decreased to about one organism per 512 ft².

Most of the organisms encrusting manganese crusts are relatively small (less than two-thousandths of an inch long) and cannot be identified in bottom photographs. The observed fauna is overwhelmingly composed of various types of sessile, suspension feeders. Estimates of infaunal organisms are not included, and highly mobile organisms may be under-represented in the data due to avoidance of the camera.

Detrimental Effects of Mining

1. Direct destruction of precious coral and deep-sea shrimp populations, squid eggs, or their respective habitats by the miner or subsequent sedimentation of discharged materials.
2. A reduction in bottom habitat of 11 mi²/year at mining sites.
3. Destruction of between 10,000 (at 7,900 feet) and 100,000 (at 2,600 feet) epibenthic macro-organisms at mine sites.
4. Effects on groundfish or pelagic fish adults or larvae from turbidity plumes generated above the bottom by mining or at the surface from shipboard dewatering operations.
5. A reduction in phytoplankton productivity due to shading by solid particulate matter in the surface discharge plume.
6. Death of plankton and/or pelagic fish larvae due to thermal shock.
7. An elevation in substrate available for bacterial growth in the water column due to particulates in the discharge plume.
8. Possible aggregation of pelagic fishes by the surface mining ship.
9. Minor behavioral disruptions to the endangered humpback whale, the green sea turtle, and resident marine mammals.

¹U.S. Department of the Interior, Minerals Management Service, Dept. Environmental Impact Statement: Proposed Mineral Lease Sale in the Hawaiian Archipelago and Johnston Island Exclusive Economic Zones, Honolulu, HI, 1987.

Threatened and Endangered Species

The Endangered Species Act of 1973 (ESA)⁷⁸ prohibits "attempts" to harass, pursue, hunt, etc., listed species. The ESA also prohibits significant environmental modification or degradation to the habitat used by threatened and endangered species, as well as any act that significantly disrupts natural behavior patterns.

Living within the general proposed lease area of the cobalt crusts are the endangered Hawaiian monk seal (*Monachus schauinslandi*), the endangered humpback whale *Megaptera novaeae gliae*, the threatened green sea turtle (*Chelonia mydas*), an occasional endangered hawksbill (*Eretmochelys imbricata*), the threatened loggerhead (*Caretta caretta*), the endangered leatherback (*Dermochelys coriacea*) and the threatened Pacific ridley (*Lepidochelys olivacea*) sea turtles. However, in

⁷⁸16 U.S.C. 1531



Photo credit: U. S. Geological Survey

Deep-sea Hydrothermal vent communities consist of exotic life forms such as these giant tube worms and crabs from the East Pacific Rise.

recognition of these species' presence, the more densely populated areas have been excluded from leasing.

Gorda Ridge Task Force Efforts

In 1983, a draft Environmental Impact Statement was circulated by the Minerals Management Service in preparation for a polymetallic sulfide minerals lease offering in the Gorda Ridge area. Much of the discussions of potential environmental impacts drew from the DOMES work because there was little site-specific information to summarize. In response to concerns that there was too little information to adequately characterize the effects of any prospecting or mining operation, the Gorda Ridge Task Force was set up to augment the draft EIS.

The major research efforts focused on characterization of the mineral resources and led to the discovery of large deposits in the southern Gorda Ridge. However, a series of reports was also prepared by the State of Oregon under the Task Force's oversight summarizing the state of scientific information relating to the biology and ecology of the Gorda Ridge Study Area. The reports included information on the benthos,⁷⁹ nekton,⁸⁰

⁷⁹M. A. *Bendis* and G. L. Taghon, *The State of Scientific Information Relating to Biological and Ecological Processes in the Region of the Gorda Ridge, Northeast Pacific Ocean: Benthos, State of Oregon*, Department of Geology and Mineral Industries, Portland, OR, Open File Report O-86-6, February 1986.

⁸⁰J. T. *Harvey* and D. L. Stein, *The State of Scientific Information Relating to the Biology and Ecology of the Gorda Ridge Study Area, Northeast Pacific Ocean: Nekton, State of Oregon*, Department of Geology and Mineral Industries, Portland, OR, Open File Report O-86-7, February 1986.

Box 6-H.-Gorda Ridge Study Results

Plankton

Most work on the study area is now 10-20 years old. No information exists on feeding ecology, secondary production, and reproduction. The phytoplankton community is dominated by diatoms. Many estimates of phytoplankton abundance were made in the 1960's;¹ they indicate productivity in this region is low (e.g., chlorophylla concentration ranges from 0.1-0.8 mg/m³ throughout the year).

Nekton

Only one species—albacore (*Thunnus alalunga*) is commercially fished in the Gorda Ridge Lease area. Larvae and juvenile form of other commercially important species (the Dover and Rex sole) occur within the area. These larvae are far west of the shelf and slope areas where the adult populations live, and their survival and input to the commercial fishery population is unknown. While occurrences of species of fish, shrimps, swimming mollusks (cephalopods), and mammals with the Gorda Ridge area are fairly well-known, their abundances, reproduction, growth rates, food habits, and vertical and horizontal migratory patterns are not.

Benthos

Little is known about the benthos of the Gorda Ridge area. Until recently, these rocky environments were avoided by benthic ecologists because of the difficulty in sampling them. Photographic surveys from the submersibles Alvin (1984) and Sea Cliff (1986) as well as from a towed-camera vehicle behind the S..P. Lee (1985) provide most of the benthic information for this area. The Gorda Ridge rift valley animals appear to be primarily filter feeders and detritus feeders. Soft sediment and rocky epifaunal communities appear to differ in species composition; however, quantitative data from controlled photographic transects across the Ridge and taken close to the substrate (3-6 ft. off the bottom) are needed to permit identification of smaller organisms. Non-vent areas may represent several types of environment with some areas of high particulate organic material concentrated by topographic features juxtaposed with off-axis rocky surfaces.

¹S.G. Ellis, and J.H. Garber, *The State of Scientific Information Relating to the Biology and Ecology of the Gorda Ridge Study Area, Northeast Pacific Ocean: Plankton*, Open-File Report 0-S6-S, State of Oregon, Department of Geology and Mineral Industries (Portland, OR: February 1986).

plankton,⁸¹ seabirds,⁸² and epifaunal and infaunal community structure.⁸³ The information contained in these reports was collected from a variety of sources such as peer-reviewed journals, government

⁸¹S.G. Ellis and J.H. Garber, *The State of Scientific Information Relating to the Biology and Ecology of the Gorda Ridge Study Area, Northeast Pacific Ocean: Plankton*, State of Oregon, Department of Geology and Mineral Industries, Portland, OR, Open-File Report O-86-8, February 1986.

⁸²L.D. Krasnow, *The State of Scientific Information Relating to the Biology and Ecology of the Gorda Ridge Study Area, Northeast Pacific Ocean: Seabirds*, State of Oregon, Department of Geology and Mineral Industries, Portland, OR, Open File Report O-86-9, February 1986.

⁸³A.C. Carey, Jr., D.L. Stein, and G.L. Taghon, *Analysis of Benthic Epifaunal and Infaunal Community Structure at the Gorda Ridge*, State of Oregon, Department of Geology and Mineral Industries, Portland, OR, Open File Report 0-86-11, July 1986.

investigators, and active researchers, as well as less traditional sources such as fishing records, etc. The reports are useful compendia identifying what baseline information exists for biota at and near the proposed lease area and what missing information needs to be developed before the effects of a mining operation can be fully characterized (see box 6-H).

While active vent sites such as the Gorda Ridge area often contain lush communities of unique species, the MMS has decided it will not lease such areas for mining should they be encountered. Thus, their discussion is not included here.

⁸⁴Thus far, none have been found on the Gorda Ridge sites.

Chapter 7

**Federal Programs for
Collecting and Managing
Oceanographic Data**

CONTENTS

	<i>Page</i>
Introduction	249
Management of Data Resources	250
Technology	251
Conceptual	251
Organization..	252
Funding	253
Survey and Charting Efforts	254
USGS: The GLORIA Program	254
NOAA: The Bathymetric Mapping Program	255
Other Data Collection Programs	256
National Oceanic and Atmospheric Administration	256
U.S. Department of the Interior	263
National Aeronautics and Space Administration.	265
U.S. Navy	266
State and Local Governments	267
Academic and Private Laboratories	267
Industry	267
Classification of Bathymetric and Geophysical Data	268
Earlier Reviews of Data Classification	271
OTA Classification Workshop	273
Observations and Alternatives	276

Box

<i>Box</i>	<i>Page</i>
7-A. Major Producers and Users of EEZ Data.	250

Figures

<i>Figure No.</i>	<i>Page</i>
7-1, Regional Atlases of the EEZ	258
7-2. MMS Seismic Data.	264
7-3. Sea Beam Bathymetry of Surveyor Seamount.	269

Table

<i>Table No.</i>	<i>Page</i>
7-1. Funding for EEZ Programs	254

Federal Programs for Collecting and Managing Oceanographic Data

INTRODUCTION

Several Federal agencies have responsibility to survey and collect data on the ocean. They are:

- U.S. Geological Survey (USGS),¹
- National Oceanic and Atmospheric Administration (NOAA),²
- U.S. Coast Guard (USCG),³
- U.S. Environmental Protection Agency (EPA),⁴
- U.S. Department of Energy (DOE),⁵
- Minerals Management Service (MMS),⁶
- the Bureau of Mines (BOM),⁷ and

- the U.S. Navy.⁸

Some of the designated agencies do not maintain active research programs in the Exclusive Economic Zone (EEZ). Of those collecting data, some are involved in survey activities while others conduct more localized research. The agencies conducting **broad-scale** exploration of the EEZ are NOAA (the Department of Commerce) and USGS (the Department of the Interior). Several agencies and public and private laboratories collect EEZ information ranging from site-specific mineral analyses to assessments of biological resources and various physical and chemical parameters of the oceans; these data collectors include NOAA (four groups),⁹ MMS, BOM, USGS, the National Aeronautics and Space Administration (NASA), the U.S. Navy, private industry, and academic and private laboratories (see box 7-A). All of their data must be archived and accessed.

Exploration and development of the U.S. Exclusive Economic Zone is not proceeding economically or efficiently under current programs. There is no systematic mechanism for data collection, with the exception of plans to 'map' the EEZ (by USGS using the GLORIA side-looking sonar system and NOAA using multi-beam systems). The NOAA and USGS efforts will provide the first survey of the vast territory contained in the EEZ; these projects, however, are plagued by budget problems, and completion is uncertain. The many other stages of research necessary before development of U.S. seabed resources can take place (e. g., comprehensive three-dimensional mineral assessment, development of rapid sampling technologies, etc.) are largely either unplanned or proceeding in a piecemeal fashion.

⁸ 10 U.S.C. 7203 and 10 U.S.C. 5151.

⁹ National Ocean Service, including the Strategic Assessment Branch and Charting and Geodetic Services; National Marine Fisheries Service; the National Environmental Satellite, Data, and Information Service, including the National Geophysical Data Center and the National Oceanographic Data Center; and the Office of Oceanic and Atmospheric Research.

¹ 43 U.S.C. 31 (a) and (b), The Organic Act of 1879, as amended; 16 U.S.C. 1451-1456, Public Law 94-370, The Coastal Zone Management Act Amendments of 1976; 43 U.S.C. 1865, Public Law 95-372, The Outer Continental Shelf Lands Act Amendments of 1978; 30 U.S.C. 1419 et seq., Public Law 96-283, The Deep Seabed Hard Mineral Resources Act of 1980; 43 U.S.C. 1301, Public Law 92-532, The Marine Protection, Research, and Sanctuaries Act of 1972; and Proclamation #5030, 48 Fed. Reg. 10605, Mar. 10, 1983.

² 33 U.S.C. 883 et seq., The Act of Aug. 6, 1947, as amended; 84 Stat. 2090, Presidential Reorganization Plan No. 4 of 1970—Establishment of NOAA; 33 U.S.C. The National Ocean Pollution Planning Act of 1978; 16 U.S.C. 1451-1456, Public Law 94-370, The Coastal Zone Management Act Amendments of 1976; 43 U.S.C. 1847, Public Law 95-372, The Outer Continental Shelf Lands Act Amendments of 1978; 30 U.S.C. 1419, Public Law 96-283, The Deep Seabed Hard Mineral Resources Act of 1980; 16 U.S.C. 1432, 33 U.S.C. 1441, Public Law 92-532, The Marine Protection, Research and Sanctuaries Act of 1972; 16 U.S.C. 1801 et seq., Fishery Conservation and Management Act of 1976, and Proclamation No. 5030, 48 Fed. Reg. 10605, Mar. 10, 1983.

³ 43 U.S.C. 1865, Public Law 95-372, The Outer Continental Shelf Lands Act Amendments of 1978.

⁴ 33 U.S.C. 1251 et seq., Public Law 95-217, The Clean Water Act, as amended; 33 U.S.C. 1401, et seq., Public Law 92-532, The Marine Protection, Research, and Sanctuaries Act of 1972.

⁵ 4, Public Law 93-577, Federal Non-Nuclear Energy Research and Development Act of 1974; 301, Public Law 95-91, Energy Organization Act

⁶ 43 U.S.C. 1131-1356, Public Law 83-212, Public Law 93-627 and Public Law 95-372, The Outer Continental Shelf Lands Act of 1953 as amended; 43 U.S.C. 1301-1315, Public Law 83-31, The Submerged Lands Act; 33 U.S.C. 1101-1108, Public Law 89-454, The Coastal Zone Management Act of 1972; 43 U.S.C. 4321, 4331-4335, 4341-4347, Public Law 91-190, The National Environmental Policy Act of 1969; Proclamation No. 5030, 48 Fed. Reg. 10605, Mar. 10, 1983, Exclusive Economic Zone of the United States of America.

⁷ 30 U.S.C. 21 (a), Public Law 91-631, The Mining and Minerals Policy Act of 1970; 30 U.S.C. 1602, 1603, Public Law 96-479, The National Materials, and Minerals Policy, Research, and Development Act of 1980.

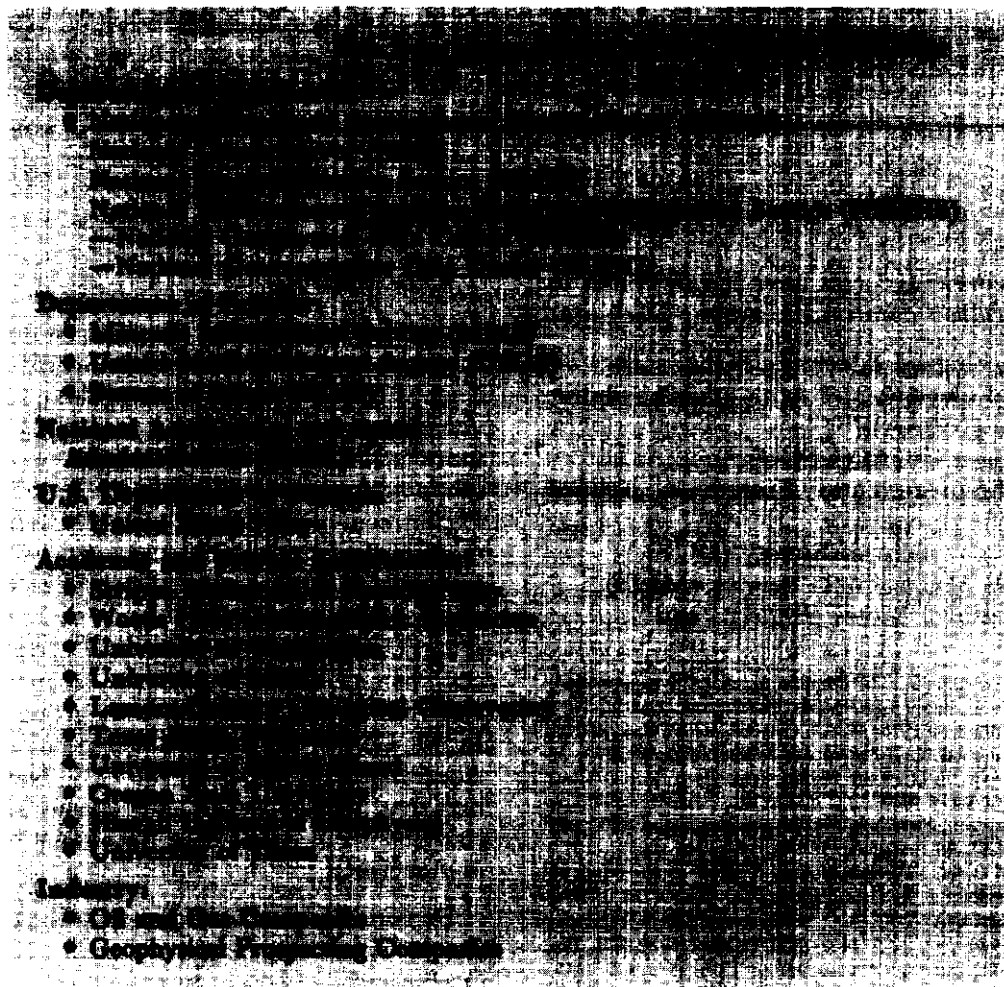

MANAGEMENT OF DATA RESOURCES

Effective data management is a critical part of any systematic survey or research effort,¹⁰ but management of EEZ data has been elusive. There are several aspects to the problem. Many different groups (Federal laboratories and agencies, State geologists, academic research laboratories, and industry) collect, use, and/or archive many kinds of data from the EEZ. Data of many kinds and different quantities are collected. Consistent reporting formats are not necessarily used. These problems will worsen as sensors (e. g., satellites, multi-beam echo-

sounders, and multi-channel seismic reflection recorders) produce data at faster rates. Realization of the scope of this data management problem is growing.^{11 12 13}

¹⁰Data management is defined as the process of planning, collecting, processing, and analyzing for primary use (e. g., for research); and storing, archiving, and distributing the acquired data for secondary users.

¹¹ "There are problems with the way data are currently managed. The distribution, storage, and communication of data currently limit the efficient extraction of scientific results . . ." National Research Council, *Data Management and Computation, Volume 1: Issues and Recommendations* (Washington, DC: National Academy Press, 1982).

¹² "Given the lack of long-term interest in managing the national environmental data archive in academia and the private sector, the Federal government must be responsible for maintaining this national asset . . ." National Advisory Committee on Oceans and Atmosphere, *An Assessment of the Roles and Missions of the National Oceanic and Atmospheric Administration*, unpublished report, 1987, p. 71; . . . Current NOAA data management systems and policies need to be carefully reexamined. . . . If urgent steps are not taken, . . . the utility of the NESDIS data centers, a national asset, will continue to

There are several possible constraints to an effective EEZ data management program. They are:

- **technology**—hardware/software,
- **conceptual**—how should the data be managed,
- **organization**—capacity for collecting and archiving data, and
- **economic**—adequate funding.

Technology

Computer, software, and recording technologies have advanced dramatically during the past few years and are expected to continue to advance rapidly. Technologies for collecting, aggregating, transmitting, and accessing data are not limiting. None of the key data managers queried by OTA¹⁴ thought the rate of EEZ data acquisition would exceed the capacity of, or tax, existing high-density magnetic tape storage. The promise of optical laser disks a few years hence could make digital data storage easily manageable. Storage of analog data, or actual physical and chemical samples (e. g., sediment cores), remains a substantial problem. However, these are physical space problems as opposed to data management problems per se. If all data could be converted to digital form, technology op-

decline." Ibid., p. 63; ". There are three principal requirements that are integral to this issue: (1) steadily upgraded computer systems are needed to manage the expanding rate of data acquisition; (2) complicated data management decisions must be made regarding (a) amount and type of data to archive and (b) optimal format for future use; and (3) a more responsive and efficient mechanism for the continued delivery of valuable and timely data products . . . must be found. Ibid.

¹³ "The quantity of geophysical data obtained with public funding has increased dramatically in the past few decades. These data are used not only by the scientific community, but are also important to the general public for use by engineers, lawyers, and insurance actuaries as examples. Collected often at enormous expense, they represent a national resource that must be managed carefully to ensure they are preserved and available when needed. Because of a substantial increase in the amount and complexity of geophysical data being collected and in the demands for them, the management policies and procedures that have been developed are no longer adequate." National Research Council, *Policy Issues Concerning Geophysical Data*, A Draft Report prepared by the Geophysics Study Committee for the Geophysics Research Forum, February 1986.

¹⁴ Roy L. Jenne, Head Data Support Section, National Center for Atmospheric Research; Michael Chinnery, Director, National Geophysical Data Center (NGDC); Michael Loughridge, Chief, NGDC Marine Geology and Geophysics Division; Gregory Withee, Director, National Oceanographic Data Center (NODC); Robert Locherman, Information Services Division, NODC; Edward Escowitz, Office of Marine Geology, USGS; D. James Baker, Director of JOI, Inc.; Ross Heath, Oregon State University.

tions for storage, maintenance, and dispersal are not limiting.

Conceptual

Data management has been the subject of many exhaustive studies.¹⁵ While the volume of information collected from the EEZ does not nearly approach the volume of space data collected by satellites, many of the principles and recommendations for handling space data are applicable to the EEZ as well. These principles include:

- involvement of scientists in data collection programs from inception to completion,
- peer-review of data management activities by the user community,
- proper documentation of all data sets that have been validated, and
- adequate financial resources allocated early in each project for database management and computation activities.¹⁶

There are also important differences in data obtained in the EEZ and data taken from space. Unlike satellite information, much of the EEZ data has not been collected in digital form and cannot be easily archived or manipulated. EEZ data also vary in geographic scales and degree of detail (a 60-km-wide GLORIA swath v. a 200-m-wide SeaMARC CL swath) and may consist of different measures, e.g., water current measurements, sediment depth, and bedrock type. Researchers would like to be able

¹⁵Four studies pertaining to data management have been produced by the National Research Council of the National Academy of Sciences alone (Washington, DC: National Academy Press): "Geophysical Data Interchange Assessment, 1978; "Solar-Terrestrial Data Access, Distribution, and Archiving, 1984; "Geophysical Data Centers: Impact of Data-Intensive Programs," 1976; and "Policy Issues Concerning Geophysical Data, (in review). From other groups: "Research Data Management in the Ecological Sciences, *Proceedings of the 1983 Integrated Data Users Workshop*, Nov. 1-2, 1983, USGS, Reston, VA (Oak Ridge National Laboratory, TN); "Frontiers in Data Storage, Retrieval and Display," *Proceedings of a Marine Geology and Geophysics Data Workshop*, Nov. 5-7, 1980 (Boulder, CO: National Geophysical and Solar-Terrestrial Data Center, 1980); and *Proceedings of Marine Geological Data Management Workshop*, May 22-24, 1978 (Boulder, CO: NOAA, 1978). Several papers by Roy L. Jenne, Head, Data Support Section, National Center for Atmospheric Research, include: "Strategies to Develop and Access Large Sets of Scientific Data," 1980 and "Data Archiving and Management, 1986.

¹⁶National Research Council, Space Sciences Board, *Data Management and Computation, Volume 1: Issues and Recommendations* (Washington, DC: National Academy Press, 1982).



Photo credit: Ted Spiegel

Banks of disk-drive units retrieve and store information at USGS headquarters in Reston, Virginia.

to superimpose many kinds of features, e.g., site-specific mineral samples on bathymetric maps that include information about the physical and chemical properties of an area. Aggregation of such disparate data sets makes EEZ data management particularly difficult.

Missing components in the current EEZ data programs are interagency/intergovernmental approaches, regional databases/datacenters, and private-public cooperatives. Activities that require attention include acquisition of wider ranges of data sets, preparation of comprehensive inventories of public domain data sets, quality control of existing data sets, and reformatting data sets so that they can be integrated for interdisciplinary research. An *inventor-y* of available data is needed along with an assessment of its adequacy.

Organization

The nucleus for a comprehensive data management system exists. A joint USGS/NOAA Office for Research and Mapping in the Exclusive Economic Zone¹⁷ is being created to coordinate the plans and activities of these two major government agencies concerned with the EEZ and to provide a focus for activities of other government agencies and private academic and industrial institutions. 18 Many interagency agreements exist that provide for and/or encourage the transfer of geophysical and

¹⁷Charter to be released in 1987.

¹⁸One of the functions of this office will be to "develop a 10-year National EEZ plan to include goals, priorities, resources, and short/long term strategies. An annual report will be made to Congress outlining yearly activities, significant results, and recommendations.

oceanographic data from the collecting agencies such as USGS, MMS, and the Department of Defense (DoD) to the two major NOAA national data centers—the National Oceanographic Data Center (NODC) in Washington, D. C.,¹⁹ and the National Geophysical Data Center (NGDC) in Boulder, Colorado.²⁰

Data collected by the academic community under the auspices of the National Science Foundation (NSF), Division of Ocean Sciences, should be ultimately submitted to the national centers. The Division's Ocean Data policy specifies that lists of all data collected under its sponsorship (primarily marine geology and geophysics data) 'be submitted to the appropriate NOAA/NESDIS [National Environmental Satellite, Data, and Information Service] national data center within 30 days of the completion of each cruise, that surface and mixed-layer temperature and salinity data "be submitted in real time" (i.e., within 48 hours of the observation), and that longer term data be submitted within 2 years. This policy seeks to ensure an appropriate balance between the needs of NSF researchers and secondary users. Producers, managers, and secondary users of oceanographic data have responded well to this policy; unfortunately, there is no mechanism for *mandating* transfer of the actual data at the completion of a grant period. Incentives to suppliers, such as reimbursement for the cost of copying data, formatting it in a standard way, and other hardware/software expenses would greatly facilitate archiving of data. The details of the NSF requirements are now under review, and a revised data policy is expected in early 1988. At the request of U.S. academic research scientists,²¹ NSF agreed to explore with other Federal agencies whether the NSF ocean data policy could serve as the basis for

development of a government wide ocean data policy. NSF has convened two meetings of agency experts to consider this question. This effort could result in a draft ocean data policy presented to each of the interested agencies for their review and adoption by the beginning of the 1988 fiscal year.²²

Funding

Since fiscal year 1980, the base funding for NODC²³ and NGDC²⁴ has diminished in real dollars. At the same time, the workloads of both centers have increased. Estimates indicate that the digital data storage requirements for NODC will triple in the next 5 years and will double for NGDC.

Based on general operating budgets for some national data centers and funds spent for data collection operations by the Federal agencies, it is estimated that funds for storage are less than 1 percent of the funds spent on data collection. Some estimate that this proportion should be in the range of 5 to 10 percent. In contrast, the geophysical prospecting data industry commonly invests 10 to 200 percent of the costs of collecting marine data in processing and archival;²⁵ the actual percentage varies depending on the cost of data acquisition—about 200 percent in the Gulf of Mexico where costs are low and 10 percent in less accessible regions such as the Beaufort Sea. As a result of chronically low funding, national data centers have been able to preserve only a small fraction of the collected data, and many important data sets have been lost.

Some fraction of this loss is likely due to the data collector and primary user not planning for or considering secondary use. But funding agencies must also bear some responsibility for ensuring that data are properly preserved and maintained. An appropriate amount of data management money should be included in grants—and not at the expense of funding for the research that collects the data.

¹⁹For example, an informal working agreement specifies that the Bureau of Land Management require its contract researchers to provide all data for archival in NESDIS centers (1978) and that the National Science Foundation require that appropriate data collected by researchers working under NSF Ocean Sciences sponsorship be provided to NESDIS centers as part of contract fulfillment (1982).

²⁰For example, Marine Geological and Geophysical Data Management Agreement, NOAA and USGS, April 1985; and Geological and Geophysical Data Dissemination Agreement, MMS and NOAA, May 1985. Other interagency understandings (with NSF, NOS, and DOD) are rooted in policy, precedent, and unilateral instruction but are not spelled out in formal interagency agreements.

²¹As part of planning for data management activities in support of the Tropical Ocean Global Atmosphere Study (TOGA) and the World Ocean Circulation Experiment (WOCE).

²²L. Brown, National Science Foundation, pers. com. to Richard Vetter, OTA contractor, Apr. 13, 1987.

²³NODC funding: Fiscal year 1982 (\$4.5 million), Fiscal year 1983 (\$4.6 million), Fiscal year 1984 (\$4.1 million), Fiscal year 1985 (\$4.1 million), Fiscal year 1986 (\$3.8 million), Fiscal year 1987 (\$3.6 million).

²⁴NGDC funding: Fiscal year 1980 (\$3.1 million), Fiscal year 1981 (\$3.1 million), Fiscal year 1982 (\$3.1 million), Fiscal year 1983 (\$3.0 million), Fiscal year 1984 (\$2.8 million), Fiscal year 1985 (\$2.7 million), Fiscal year 1986 (\$2.6 million).

²⁵Carl Savit, western Geophysical Company, pers. com. to Richard Vetter, OTA contractor, Nov. 25, 1986.

According to NGDC, "If funding agencies abdicate their responsibility for the processing of data to a stage usable by others and the long-term preservation of the data, they have in fact created a burden for the scientific community and create the possibility of non-productive and redundant collections of data."²⁶ When secondary usage is not planned

²⁶M. S. Loughridge, "Frontiers in Data Storage, Retrieval, and Display, *Proceedings of the Marine Geology and Geophysics Data Workshop*, Nov. 5-7, 1980 (Boulder, CO: National Geophysical and Solar-Terrestrial Data Center, 1980), p. 145.

for, it either takes large expenditures to "reconstitute" the data, or the data never become available to the secondary user.²⁷

²⁷A simple library function can prevent data duplication. NGDC has a data base called GEODAS (Geophysical DATA System) which identifies where data have been collected and by whom. The new user is then faced with copying and converting the data.

SURVEY AND CHARTING EFFORTS

NOAA's National Ocean Service (NOS) and the USGS Office of Energy and Marine Geology are the civilian organizations with primary responsibilities related to acquisition and processing of bathymetric and geologic data within the U.S. EEZ. While source data should be archived in a national database (NGDC), the evaluation of data quality and processing of the data into maps and charts, digital or analog, is a responsibility which must continue as a part of the NOS and USGS missions. Effectively, NOS and USGS produce the Federal assessment of the best geographic depiction of these data. It is important that both agencies acquire the capability to establish and maintain these data sets in digital form. Without such efforts each individual user would have to judge data quality and process a myriad of data sets which would be a costly endeavor.

In 1984, USGS and NOAA signed a Memorandum of Understanding²⁸ to conduct joint mapping and survey efforts in the EEZ. Funds appropriated to USGS and NOAA have been increasingly re-programmed to support this research over the last 3 years. Total EEZ exploration funds in the Federal agencies were \$9 million in 1984, \$12 million in 1985, and about \$16 million in 1986 (table 7-1). Eighty percent of the money for EEZ exploration is within USGS and NOAA budgets; the GLORIA and multi-beam survey programs consume virtually all of this funding.

²⁸Cooperative program for bathymetric survey by NOAA and USGS, signed by both J. Byrne and D. Peck, April 1984.

Table 7-1.-Funding for EEZ Programs

Agency	Fiscal year (million dollars)		
	1984	1985	1986
Department of Commerce:			
National Oceanic and Atmospheric Administration	1.0	4.4	^a 5.0
Department of the Interior:			
U.S. Geological Survey	4.7	5.1	8.4
Minerals Management Service	2.7	1.8	1.6
Bureau of Mines	0.3	0.2	1.2
Total funding	8.7	11.5	16.2

^aA SeaBeam system was purchased for an additional \$2 million.

SOURCE: Office of Technology Assessment, 1987

USGS: The GLORIA Program

The USGS GLORIA mapping program is intended to provide a complete and broad overview of the U.S. EEZ (see ch. 4). Currently, about 30 percent of the EEZ²⁹ has been surveyed with GLORIA. At the present rate, the entire U.S. EEZ will be covered by the end of 1996. The time lag between surveying and publication of maps is about 1 ½ years.³⁰ USGS intends to distribute GLORIA data to the public through NGDC; however, none has yet been archived. All of the swath data are digital and stored on magnetic tape. These data must be combined with navigational information to be of full value.

²⁹About one million square nautical miles.

³⁰To date, the EEZ off the west coast (California, Oregon, Washington), in the Gulf of Mexico, and off Puerto Rico/U. S. Virgin Islands has been mapped. The *West Coast Atlas* was published in March 1985 on the second anniversary of the EEZ declaration, The *Gulf of Mexico Atlas* will be published in August 1987.

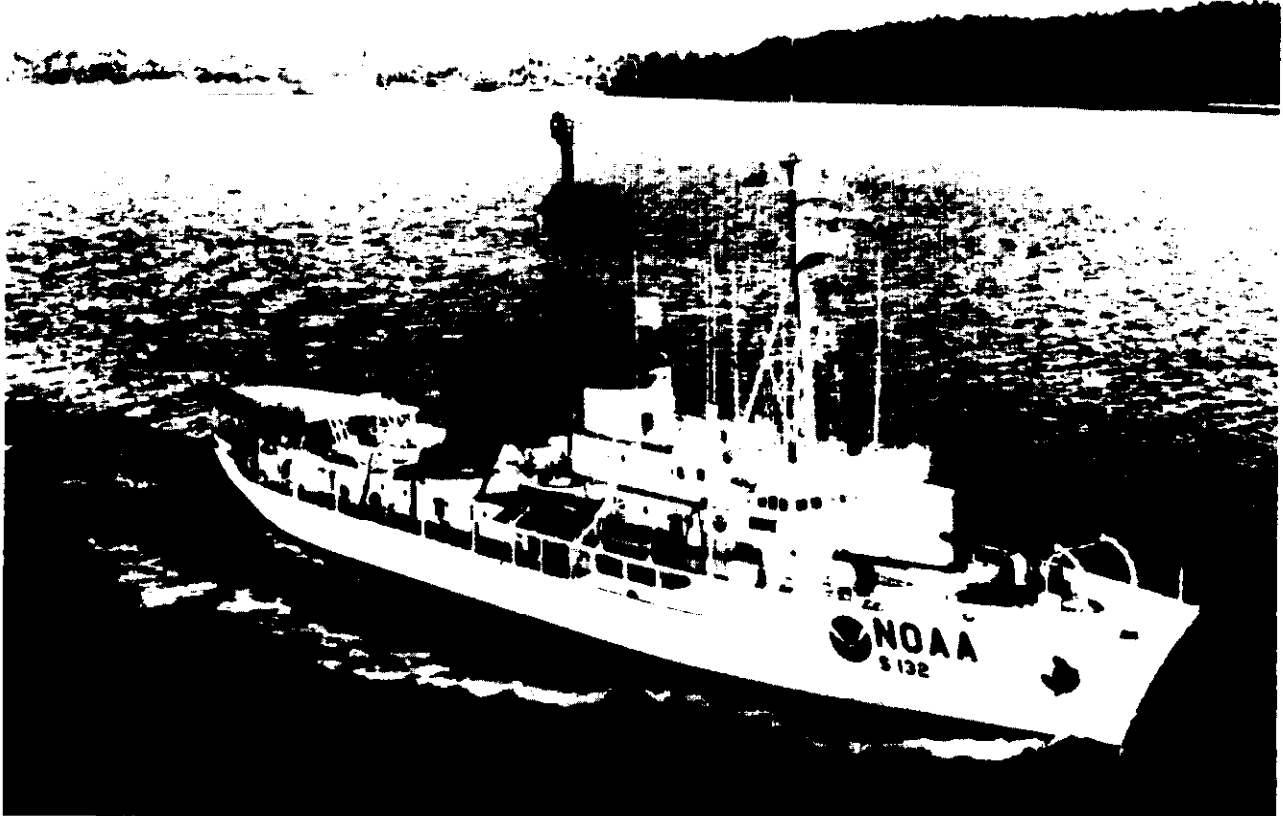

Photo credit: National Oceanic and Atmospheric Administration

The NOAA ship *Surveyor* is equipped with the Sea Beam system for detailed bathymetric mapping of the EEZ.

USGS considers the GLORIA program a 'showcase' success and is committed to its completion. However, recent budget cuts will at least delay if not permanently inhibit the project. The Office of Energy and Marine Geology had a budget of \$24 million for marine geology in 1986. This is the total EEZ expenditure within USGS, which includes \$18 million for salaries and overhead. The entire operating expenses budget of this office is spent on the GLORIA survey (see table 7-1). Only modest funds are expended on other activities, e.g., analyzing mineral contents of vibrocores.³¹ All Geological Framework studies were discontinued in 1982, also because of budget constraints. USGS has a contract through 1991 with the British Institute of

³¹ USGS estimates that two people spend 20 percent of their time analyzing mineral core samples. At this rate, the backlog of 1,000 cores will take 10 to 15 years to complete; plans to procure more cores from areas identified as economically promising based on this initial screening have been discontinued due to lack of funds.

Oceanographic Sciences (IOS) which operates the GLORIA equipment. If USGS cannot meet the terms of the contract, a significant financial penalty will be imposed and USGS could lose the GLORIA system. Although the United States is developing similar technologies, no system with the swath width of GLORIA will be available in the foreseeable future if the current system is returned to IOS.

NOAA: The Bathymetric Mapping Program

The National Ocean Service of NOAA is producing very detailed bathymetric maps of the EEZ using multi-beam or swath echo-sounders in conjunction with precise navigational positioning (see ch. 4). A bathymetric map can be constructed within 6 months of collecting multi-beam data, in striking contrast to the years needed to produce maps and charts manually. Individual field surveys

are typically processed in 3 weeks or less, provided no major system problems are encountered. Two mapping systems developed by the General Instrument Corp. are the Sea Beam system and the Bathymetric Swath Survey System (BS³) used aboard ships of the NOAA fleet. A more modern version of BS³ called Hydrochart II is now available from General Instrument. Japan has deployed the first system. NOAA intends to use Hydrochart 11 or its equivalent on the U.S. east coast and to upgrade BS³ to the same system. Swath data are now classified (see the last section in this chapter).

NOAA has operated multi-beam survey ships since the mid to late 1970s. The EEZ swath mapping program began in 1984 and covered about 150 square nautical miles. During 1985, about 1 ½ ship-years were logged covering about 6,400 square nautical miles. In 1986, approximately 2 ship-years completed another 14,000 square miles. By the end of 1986, NOS had 3 ships in operation acquiring swath data, and about 1 percent of the total U.S. EEZ had been mapped. NOS staff estimate that it will take about 143 ship-years to survey the entire EEZ and that about 150,000 reels of magnetic tape will be required to store the entire set of original data. To date, about 6,000 magnetic tape reels of swath data have been recorded and stored. The storage problem is significant though not insurmountable. NOS is currently evaluating the possibility of using optical disk technology for long-term storage of EEZ bathymetric data. NOAA intends to archive all original data as a source database for use by other researchers. NOS will process the data into two gridded data sets:

1. Metric data in the UTM (Universal Transverse Mercator) projection to construct bathymetric maps, and
2. English (feet or fathom) data in the Mercator projection to construct nautical charts.

Both gridded data sets will be processed into digital graphics for use in electronic chart systems and the construction of map and chart hard copy graphics.

In conjunction with the swath data, other ancillary data are collected by ships. These data include 3.5 and 12 kilohertz underway bottom-profiling systems and surface weather observations.³²

Since 1980, the budgets for mapping, charting, and geodesy programs in NOAA have shrunk 10 to 20 percent (unadjusted dollars). Ship support funds also have been reduced over this period. Currently, EEZ multi-beam efforts represent about 10 percent of the NOAA surveying and mapping activities. Bathymetric surveys are not a line item in the NOAA budget; the level of effort increases at the expense of traditional mapping and charting activities.³³ NOAA is increasing multi-beam survey efforts in 1987 to 418 sea-days at a cost of about \$6.1 million.^{34,35} Eventually, NOAA plans to apply similar technologies within nearshore regions using experience gained with the offshore systems.

³²More detail on the NOS bathymetric mapping program may be found in the report of the December 1984 EEZ Bathymetric and Geophysical Survey Workshop, NOAA, March 1985.

³³Threeships formerly assigned to charting now do multi-beam surveys.

³⁴ Estimated from cost of ship-days in 1984-86.

³⁵ Appropriated \$1, 1 million for an additional multi-beam system.

OTHER DATA COLLECTION PROGRAMS

The National Oceanic and Atmospheric Administration

In addition to the extensive program of bathymetric mapping using multi-beam systems (described above), NOAA collects and synthesizes biological, chemical, and physical characteristics of the ocean environment. Through NESDIS, NOAA controls the major data centers for EEZ data (NGDC and NODC).

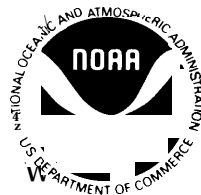

The National Ocean Service

General Physical Oceanography Programs.— NOS is the major NOAA group systematically collecting physical and geological data from the EEZ. In addition to the relatively recent swath mapping program, NOS collects and maintains tidal data along the U.S. coastline. NOS has funded the development of a state-of-the-art database management system for much of these data as part of its 'next-generation water level measurement system.' Insufficient funds have been provided to put

all of the old data into this system, and some old strip charts and hand tabulations continue to be used. NOS also maintains wave data, but there is now no adequate archival system. Within the NOS Office of Oceans and Atmospheric Research, the Sea Grant Program and the two regional laboratories³⁶ collect data as well. These efforts tend to be more in the mode of exploratory short-term data collection rather than multi-year systematic surveys.

The Strategic Assessment Branch.—The Strategic Assessment Branch (SAB) of the NOAA Office of Oceanography and Marine Assessment conducts comprehensive, interdisciplinary assessments of multiple resource uses for the EEZ to determine marine resource development strategies which will benefit the Nation and minimize environmental damage or conflicts among users.³⁷

SAB is producing a series of four regional atlases (see figure 7-1) whose maps combine the physical, chemical, and biological characteristics of resources and their environments with their economic, environmental quality, and jurisdictional aspects. The four atlases cover:

- the U.S. East Coast;
- the Gulf of Mexico;
- the Bering, Chukchi, and Beaufort Seas; and
- the U.S. west coast and Gulf of Alaska.

The maps cover a range of topics on physical and biological environments (geology, surface temperatures, aquatic vegetation . . .), more than 300 species of living marine resources (invertebrates, fishes, birds, mammals . . .), economic activities (population distribution, seafood production . . .), environmental quality (release of oil and grease discharge, bacteria . . .), and jurisdictions (political boundaries, environmental quality management areas . . .). In addition, each map is also in digital form in a computer data system with supporting software that provides the capability to prepare composite maps for combinations of species, life history, etc.³⁸ This capability may be used by visiting investigators.

³⁶The Pacific Marine Environmental Laboratory and the Atlantic Oceanographic and Meteorological Laboratory.

³⁷C.N. Ehler, D. J. Basta, T. F. LaPointe, and M. A. Warren, "New Oceanic and Coastal Atlases Focus on Potential EEZ Conflicts," *Oceans* 29 (3), 1986, pp. 42-51.

³⁸Two examples are shown in ch. 6, figures 3 and 4.

About 200 copies of the U.S. East Coast Atlas of 125 maps were published in 1980.³⁹ The *Gulf of Mexico Atlas (163* four-color maps) was printed in 1985; the *Bering, Chukchi, and Beaufort Seas Atlas (127* maps) will be printed late in 1987. The *West Coast and Gulf of Alaska Atlas* is scheduled for 1988 publication.

A "national" atlas of 20 maps on the health and use of coastal waters of the United States is also being produced. The first five maps published were: *Ocean Disposal Sites, Estuarine Systems, Oil Production, Dredging Activities*, and NOAA's *National Status and Trends Program*. Future maps are scheduled on hazardous waste sites, marine mammals, fisheries management areas and other similar topics.

Other SAB activities include an economic survey of outdoor marine recreation, a national coastal pollutant discharge inventory, a national estuarine inventory, a national coastal wetlands database, and a shoreline characterization.

National Marine Fisheries Service

The work of the National Marine Fisheries Service (NMFS) is done by 5 regional offices, 4 fisheries research centers, and 20 laboratories. The NMFS mission is: 1) to carry out national and international conservation and management of living marine resources, 2) to encourage the utilization and development of U.S. domestic fisheries and fisheries resources, and 3) to conduct bio-environmental and socioeconomic research. Work that results in the production of EEZ oceanographic data is largely carried out by the laboratories of the four fisheries centers. Some NMFS data are made available to and become part of the NODC archives.

The NMFS has an automatic data processing Telecommunications Long-Range Plan, initiated in 1981. Currently, there is active interaction between the Seattle and Miami centers and among the North East Region laboratories. The Office of Management and Budget has approved funds to provide for a major upgrade of the system during fiscal years 1988 and 1989. Most of the "traffic" consists of data on catch efforts, socioeconomic fac-

³⁹Now out-of-print.

Figure 7-1.—Regional Atlases of the EEZ

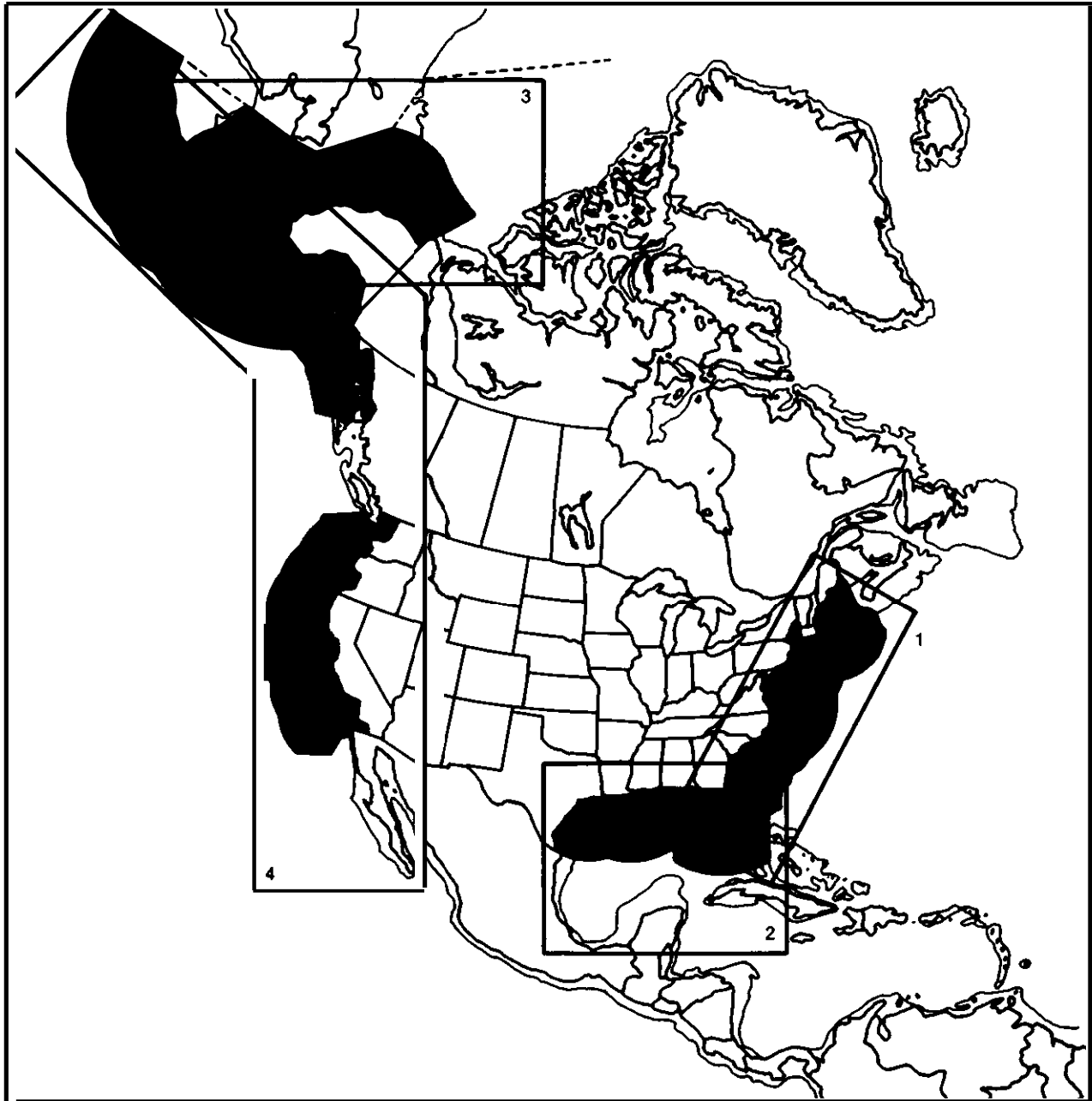

Four atlases prepared by the Strategic Assessment Branch of NOAA depict environmental, economic, and jurisdictional information useful for regional assessment of EEZ resources.

SOURCE: National Oceanic and Atmospheric Administration.



Underway Geophysics Collected in the EEZ

As the concentration of these ship tracks shows, a significant amount of geophysical information has been collected in the EEZ; however, much more mapping, sampling, and resource assessment remains to be done.

Source: National Geophysical Data Center, National Oceanic and Atmospheric Administration

tors, and administrative matters. NMFS biological-environmental data (i. e., oceanographic data) are mainly of regional interest and are shared within a region by more conventional means, such as direct exchange of “hard” or paper copy.

The National Geophysical Data Center

The mission of the National Geophysical Data Center (NGDC) is “to acquire, process, archive, analyze and disseminate solid earth and marine geophysical data . . . ; to develop analytical, . . . and descriptive products; and to provide facilities for World Data Center A.”⁴⁰ Its Marine Geology and Geophysics Division (one of four divisions) cov-

⁴⁰The World Data System A was established as part of the International Geophysical Year 1956-57 to foster data exchange between countries. World Data System A coordinates information from “free” world countries; World Data System B, from Soviet bloc countries.

ers most of the work of interest to the EEZ. The archives of this Division include some 10 million track miles of marine geophysical data, about 25 percent of which is in the U.S. EEZ. About half of the requests for data come from private industry. The next largest requesting groups are academia and the Federal Government.

Funding for NGDC activities has declined slightly from fiscal year 1981 through fiscal year 1987 while its archives and responsibilities have steadily increased. Future projections suggest an increase in data storage requirements of 600 percent (presuming only high-density magnetic tapes are used for storage) from fiscal years 1986 to 1992.

NGDC data are processed and made available to a worldwide community of clients through series of ‘Data Announcements’ on topics ranging from

common depth point seismic reflection data for specific regions of the U.S. continental shelf, to core descriptions for special areas, to high-resolution seismic reflection data, to magnetic and gravity data, to the latest data sets from the deep sea drilling project, to ice-gouge data. These announcements provide users with detailed information on the characteristics of the particular data set being offered, including related data sets, costs, and available formats.

The Marine Geology and Geophysics Division has two interactive systems for accessing worldwide marine geophysical data and geological data in the sample holdings of the major U.S. core repositories. Using software developed by the Division, a user can specify geographic area, type of geophysical measurement, sediment/rock type, geologic age, etc., and receive inventory information at a computer terminal. First operational in June 1978, these two systems are used primarily by Division personnel, but there has been experimental use at remote terminals by the staffs of Scripps Institution of Oceanography and other core repositories under data exchange agreements with NGDC and other Federal agencies. NGDC hopes to make three other data sets similarly accessible for users:

1. multi-beam echo-sounder data from NOS and other collecting institutions,
2. side-looking sonar data, and
3. digital multi-channel seismic reflection data if demand and funding warrant.

NGDC staff states that most users of Division data do not need "on-line"⁴¹ access; NGDC typically satisfies most inquiries by performing tailored searches of the data for the requestor.

Types of EEZ data held by NGDC are Marine Geological Data Bases, Bathymetry and Marine Boundary Data Bases, and Underway Geophysical Data. In terms of numbers of reels of data stored and in rates of acquisition in bytes⁴² per year, the Underway Geophysical Data sets dominate the NGDC inventory (97 percent). Most of the data sets are collected in digital form and stored on magnetic tape.

⁴¹Interactive access to the data.

⁴²One byte is the amount of computer memory used to store one character of text.

Marine Geological Databases.—There are four major categories in the geological databases: Marine Core Curator's (MCC), Marine Minerals (MM), Digital Grain Size (DGS), and Miscellaneous Geology Files (MGF).

- All of the data sets are digital, aggregated, and stored on magnetic tape except for the MGF. The amount of MGF data stored is on 20 reels of magnetic tape. The sum of the other categories is about 14×10^6 bytes, half of which are DGS data. All sets combined are on 23 reels of magnetic tape.
- The average delay between sampling and reporting is 10 years for DGS and MGF data and 2 and 5 years respectively for MCC and MM data. All four categories are provided on request.
- All data are acquired from academic or government laboratories ranging from 90 percent academic for MCC to 90 percent government for DGS. The sum of the acquisition rates for MCC, MM, and DGS is about 140 kilobytes per year (100 kilobytes per year for GDS) with MGF acquiring about 1,000 stations per year.
- Future uses are expected to increase by about 1 percent per year for MCC and GDS, 2 percent per year for MM, and 5 percent per year for MGF.

Problems Handling Geological Data.—Marine sediment and hard-rock analyses present unique data management challenges. Unlike bathymetry, for example, data volume presents no real obstacle to geological data storage and retrieval. The problem lies in the descriptive, free-form, non-standard nature of the data. There are nearly limitless varieties of analyses performed on sediment and hard-rock samples, each analysis requiring suitable documentation to make the data usable. Decisions must be made as to which types of analyses merit creation of a database and, for each type of data selected, which analyses or measurements should be stored. These decisions require input from the marine geological scientific community to be combined with data management practices to produce databases that satisfy user requirements. The non-standard form of marine geological data also makes compilation of data very labor-intensive. Much of the data must be hand encoded from descriptive data reports and other sources and entered into the

computer, in contrast to geophysical data which are collected digitally in a relatively uniform manner.

Bathymetry and Marine Boundary Data-bases.—There are four kinds of data sets included in this category: NOS Hydrographic Surveys (NOS/HS), NOS Multi-beam EEZ Bathymetry (NOS/MB), Gridded Global Bathymetry (GGB), and Marine Boundary (MB).

- The most valuable EEZ data sets in this group are those from the National Ocean Service. All NOS hydrographic surveys that are available in digital form are archived and merged into an accessible database at NGDC. All four data sets (except NOS/MB) are collecting data, are all in digital form, and all are unedited. NOS/MB data are aggregated, and NOS/HS data are reformatted to be accessible by location. (The NOS/MB data are “on hold” as a result of classification.) All data sets are on magnetic tape.
- The time lag for reporting NOS/HS data is about 2 years. All but the NOS/MB data are made available to others on request.
- The NOS/HS data are acquired at about 42 megabytes per year from the NOS. GGB was a one-time data acquisition from academic and DoD sources.
- Annual increases in uses for NOS/HS and MB data are estimated at 5 percent and GGB at 15 percent. (There is no EEZ multiple-beam bathymetry on file at NGDC because of data classification, and no acquisition is planned. NGDC does plan to index the location of survey tracklines so that operators of multi-beam systems can avoid duplication.)

Problems with Bathymetric and Boundary Data.—Transmission of survey data between NOS and NGDC has been irregular over the years, primarily because the digital versions of surveys have not been important to the nautical charting effort at NOS. Over the last 3 years, NGDC has made a consistent effort to obtain and catalog a large backlog of surveys stored at NOS headquarters. Availability of other bathymetric data sets depends on DoD classification policies. Marine boundary data are available, though they need to be centralized to be readily accessible. NGDC has the U.S. EEZ boundary points (produced by NOS) and the outer continental shelf lease area boundary points

(produced by USGS). NOS is compiling and distributing a detailed set of boundary points for the U.S. coast; these data have not been submitted to NGDC.

Underway Geophysical Data.—Four kinds of underway data are included in this category: Underway Marine Bathymetry (MB), Underway Marine Seismic Reflection (MSR), Underway Marine Magnetics (UMM), and Underway Marine Gravity.

- About 25 percent of the Underway Geophysical Data are taken in the EEZ. Data are increasing in all sets. Except for MSR, most of the data are in unaltered digital form stored on magnetic tape. The MSR data are 45 percent on paper, 40 percent on microfilm, and 15 percent on magnetic tape. While 85 percent of the MSR data are analog, the MSR digital archive alone totals about 3,000 reels of low-density tape. The remaining 3 digital sets total about 5 million records on 10 high-density reels, about half of which are MB.
- The average delay from sampling to reporting for all sets is about 5 years. All data are made available upon request.
- The combined rate of accumulation of data for all sets is about 100 megabytes per year.
- Future use for all sets is estimated to increase at about 25 percent per year.

Problems and Successes with Underway Data.—An internationally accepted format for underway geophysical data is in general use. Flow of data to NGDC has been good from the Minerals Management Service, U.S. Geological Survey, Scripps Institution of Oceanography, Hawaii Institute of Geophysics, Lamont-Doherty Geological Laboratory, and the University of Texas at Austin. Other institutions’ performances in submitting data have been spotty because they have not practiced centralized long-term data management. A considerable amount of data from some institutions has been lost or dispersed in laboratories.

The National Oceanographic Data Center

The mission of the National Oceanographic Data Center (NODC) is to acquire, archive, manage, and make oceanographic data available to secondary users. NODC has served in this capacity since

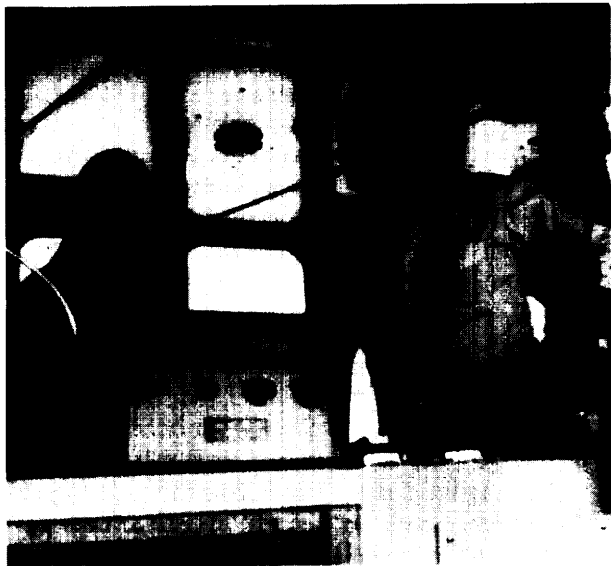

Photo credit: W. Westermeyer

Marine analysts examine instrumentation aboard the dredge *Mermentau*.

its formation in 1961 and probably now has the world's largest unclassified collection of oceanographic data.

About 95 percent of the EEZ data obtained are in digital form, the rest is in analog form. All of the data are stored on magnetic tape and comprise about 650,000 stations, equivalent to about 135 reels of magnetic tape or about 4 gigabytes. The time-lag from sampling to reporting ranges from 1 to 5 years. The rate at which data are acquired is about 650 megabytes per year, due mainly to inputs from a few high data-rate devices such as current meters.

NODC has been pivotal in the development of several data management activities that involve data that is entirely, or at least mainly, taken in the EEZ:

Outer Continental Shelf Environmental Assessment Program (OCSEAP).—OCSEAP is a comprehensive multi-disciplinary environmental studies program initiated by BLM to provide environmental information useful in formulating Alaskan oil and gas leasing decisions. Starting from a modest \$100,000 data collection program in 1975, OCSEAP had assembled by the end of 1984 over 2,500 data sets covering more than 100,000 stations and consisting of more than 4 megabytes. During

the early stages of this program, a great deal of effort was devoted to the development of data formats and codes that would support the needs of investigators and be compatible for preprocessing and converting to digital form prior to submission to NODC.

National Marine Pollution Information System (NMPIS).—NMPIS is essentially an annually updated catalog of thousands of marine pollution-related projects carried out or supported by dozens of Federal agencies. The catalog includes types of projects, types of data and/or information covered, geographic distribution, quantity of data/information, means of access, costs, and principal contacts.

Marine Ecosystems Analysis (MESA) Project.—MESA is a cooperative program between NOAA and the Environmental Protection Agency (EPA) to conduct baseline marine environmental measurements primarily in the New York Bight, New York; and Puget Sound, Washington, areas. This program, which began in 1978 and completed its data collection phase by 1983, resulted in more than 2,000 marine environmental data sets consisting of over 200,000 stations. NODC now holds these data in appropriate files in the National database.

Strategic Petroleum Reserve/Brine Disposal Program.—This NOAA program began in 1977 to provide assessment information to the Department of Energy (DOE) on environmental effects of brine discharge into the Gulf of Mexico. Baseline marine environmental measurements from monitoring efforts at discharge sites consisting of over 87,000 stations have been archived by NODC.

California Cooperative Fisheries Investigations (CALCOFI).—The CALCOFI program, largely supported by the State of California, makes oceanographic observations in conjunction with fisheries studies at a grid of stations in the California Current region off the California coast. Begun in 1949, this program has produced physical/chemical oceanographic data consisting of more than 370 data sets of over 16,500 stations which are now held by NODC.

New Efforts Underway at NODC Involving EEZ Data.—A cooperative agreement has been

signed between NOAA's National Ocean Service (NOS) and NODC to develop an Alaska regional marine database in Anchorage, Alaska, at the Office of Marine Assessment Ocean Assessment Division. NODC and NOS are both providing copies of their data holdings in the Alaska EEZ region and will provide routine updates every six months. Database maintenance will be done in Anchorage, and a full database copy will be available at the Ocean Assessment Division there and at NODC.

Consideration is being given to creating Level II satellite data sets for the EEZ at NODC. While massive global satellite data archives are available from the Satellite Data Services Division of the National Climatic Data Center, investigators require easier data access than is now possible. NODC is presently archiving and distributing data from the U.S. Navy Geodetic Satellite which provide full EEZ coverage as part of the satellite Exact Repeat Mission.

Prototype Coastal Information System Using a Personal Computer.—In 1986, NOAA developed a prototype coastal information system for the Hudson-Raritan Estuary. The system is designed for use by regional planners, environmental specialists and managers, and citizen groups with access to an IBM compatible personal computer. Information is accessed by file directory, menu, and glossary and provides output as map sections and vertical profiles with a wide variety of properties ranging from temperature through water depth.

Problems with NODC Data.—Data quality is a continuing concern for both NODC and researchers using NODC data. To address this issue, a series of 'Joint Institutes' between NODC and various research laboratories has been initiated. These institutes are located on-site at the laboratories. Data are collected, pre-processed, and checked for quality by the program's principal investigator(s) or their staff(s) before being provided to NODC for archival. One such "Joint Institute" for subsurface thermal data from the Tropical Ocean Global Atmosphere Study (TOGA) program is now operating at the Scripps Institution of Oceanography, and others are planned, depending on resources, for other programs at the University of Hawaii and the University of Delaware.

Another problem is the large number of organizations collecting marine environmental data in varying formats, employing various levels of quality control. This situation makes it both expensive and difficult to manage resulting data to the satisfaction of an equally large user community. NODC does not have financial or staff resources to routinely reformat and uniformly quality control every data set received for archival.

U.S. Department of the Interior

Minerals Management Service

The Minerals Management Service (MMS) carries out programs to implement the EEZ proclamation through its Office of Strategic and International Minerals. The programs include: formulating a mineral leasing program for non-energy minerals; establishing joint Federal-State task forces in support of preparation



of lease sale EISs through cooperative agreements; providing support for data-gathering activities of other Federal and State agencies and universities; and developing regulations for prospecting, leasing, and operations for Outer Continental Shelf/EEZ minerals.

The MMS administers the provisions of the Outer Continental Shelf Lands Act (OCSLA) through regulations codified in Title 30 of the Code of Federal Regulations. The regulations govern permitting, data collection and release, leasing, and postlease operations in the outer continental shelf. The regulations prescribe:

- when a permit or the filing of a notice requires geological and geophysical explorations to be conducted on the outer continental shelf; and
- operating procedures for conducting exploration, requirements for disclosing data and information, and conditions for reimbursing industry for certain costs.

Prior to 1976, common depth point (CDP) seismic data were primarily acquired by the government through nonexclusive contracts or as a cost-sharing participant in group shoots. As the cost of

acquiring these data increased, the concept of obtaining the data as a condition of permit was developed. Starting in 1967, the MMS has reimbursed industry permittees for reproduction costs of acquired CDP seismic data. Recent costs for such data have averaged about \$600 per mile. The MMS now holds about 1 million miles of such data, of which about 260,000 miles was acquired before fiscal year 1976 and could continue to be held as proprietary indefinitely. Data acquired after 1976 are held as proprietary by the petroleum industry for a period of time. MMS is about to propose a rule increasing the hold on such geological data from 10 to 20 years. Additionally, the agency is considering prohibiting the release of any geophysical data until the new rule goes into effect.⁴³ The effect of this new policy would be to shut off most industry-collected data from reaching the public for another decade. Approximate amounts of CDP data remaining in MMS archives for the years 1977 through 1985 are shown in figure 7-2.

Ninety-five percent of the CDP data are collected in digital form, with the remainder analog. Of the

⁴³T. Holcomb, NOAA/NGDC, Apr. 24, 1987, and D. Zinger, MMS Reston, Apr. 27, 1987, personal communications to OTA.

Figure 7-2.—MMS Seismic Data

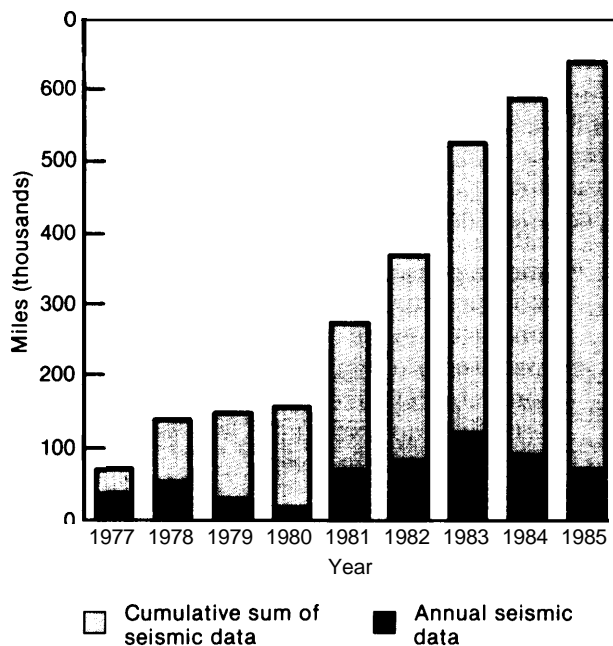

SOURCE: Office of Technology Assessment, 1987.

portion stored by MMS, 95 percent are stored on Mylar film with the remainder on magnetic tape. Except as noted above, none of the data are available to the general public. Industry is the source of all of the data and MMS expects future acquisition rates to continue at about the same rate as the past few years. These data are acquired as a condition of offshore geological and geophysical permits issued under the terms of the OCSLA. There are no problems obtaining the data, so long as MMS has the funds to reimburse the permittee for the duplication costs. MMS also collects physical oceanographic data, which accounts for about 25 percent of the MMS Environmental Studies program. These data are obtained by MMS contractors; MMS contracts now specify that data obtained under contract are to be provided in digital form to the NODC.

U.S. Geological Survey

The U.S. Geological Survey (USGS) is the dominant civilian Federal agency that collects marine geological and geophysical data. USGS conducts regional-scale investigations aimed at understanding and describing the general geologic framework of the continental margins and evaluating energy and mineral resources.

About 60 percent of the EEZ data collected are in digital form. The 'raw' field data are usually stored for some lengthy period for possible direct access. About two-thirds of the data must be merged (aggregated) with other data (usually navigation data) in order to be of value. The total amount of EEZ data collected to date is stored on about 50,000 reels of magnetic tape and is being accumulated now at about 200 reels per year. The time lag from collection to reporting is about three years for publication in a scientific journal and about one year for a seminar or an abstract at a meeting.

Future acquisition of EEZ data is expected to increase approximately 10 percent per year, mainly because new equipment allows more information to be collected per ship mile. In the past, all USGS data were copied and sent to NGDC. This policy continues except for digital seismic data; only summaries of these data are sent. NGDC then an-



nounces the availability of such data sets and, if demand warrants, the data are then sent to NGDC.

Bureau of Mines

While the Bureau of Mines (BOM) does not actively collect and archive EEZ data, BOM is a prime user of information collected by other groups. Programs related to the EEZ include development of technologies that will permit recovery of mineral deposits from the ocean floor, studies of beneficiation and processing systems, economic analyses of mineral extraction, and assessment of worldwide availability of minerals essential to the economy and security of the United States.



National Aeronautics and Space Administration

The National Aeronautics and Space Administration (NASA) flies a number of satellites carrying sensors (passive and active) that measure many ocean surface properties including temperature, color, roughness, and elevation. From these measurements, a number of important properties of the ocean can be estimated, including biological productivity, surface wind velocity, bottom topography, and ocean currents. All of these satellites obtain some small but significant percentage of their data while over the EEZ. The bulk of the ocean program data archived by NASA is located at the National Space Science Data Center at the Goddard Space Flight Center, Greenbelt, Maryland, and at the NASA Ocean Data System centered at the Jet Propulsion Laboratory, Pasadena, California. Scientific analysis of the data is performed by researchers at the two laboratories and at universities around the country.

Both laboratories are currently collecting EEZ-related data. About 80 to 100 percent of the data are digital with spatial scales of hundreds to thousands of yards and temporal scales of hours to days. Most of the data are stored in raw form on 27,000 reels of high-density magnetic tape. The time lag between data sampling and reporting is between one and two years; these data are available to

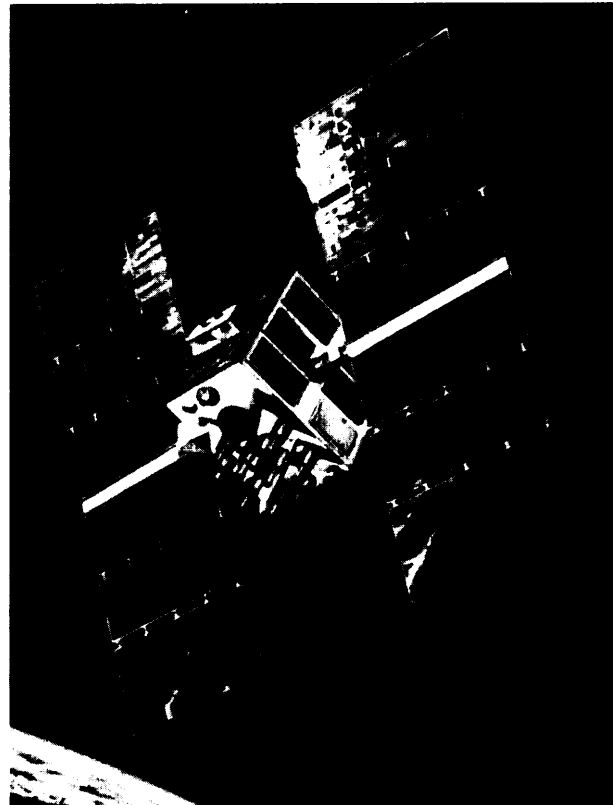

N G P g S m GPS
 D p rtm D m
 g m W
 8 GPS w m w m w

others. NASA acquires data at the rate of about 10^{12} to 10^{13} bytes per year, which is expected to increase significantly in the future.

NASA has developed pilot data management systems that have successfully demonstrated concepts such as interactive access to data previewing and ordering. These programs allow users to actually view the data available; the programs will not be fully operational before the early 1990s.

The "NASA Science Internet" (NSI) program was created in 1986 to coordinate and consolidate the various discipline-oriented computer networks used by NASA to provide its scientists with easier access to data and computational resources and to assist their inter-disciplinary collaboration and communication. NSI is managed by the Information

Systems Office within NASA's Office of Science and Applications. The Ames Research Center in Sunnyvale, California, is responsible for technical implementation of NSI. NSI services include consolidating circuit requests across NASA disciplines, maintaining a database of science requirements, disseminating information on network status and relevant technology, and supporting the acquisition of network hardware and software.

Science networks with the NSI system include the Space Physics Analysis Network, the Astronomy Network (Astronet), the network for the Pilot Land Data System, and the network planned for the earth science program. Currently, these networks support approximately 150 sites accommodating 2,000 scientists. Growth in use has been 20 to 40 percent each year across all science disciplines. NSI will coordinate links between NASA networks and networks of other agencies as well, such as NOAA, USGS, and NSF.

The West Coast Time Series project converts raw satellite data to ocean chlorophyll concentrations and sea surface temperatures (useful for studies of biological productivity and ocean circulation) in formats agreed to by the scientific user community, and provision has been made for efficient data distribution.

Problems Handling NASA Data.—Users say it is difficult to obtain complete and timely responses to requests for satellite data.⁴⁴This problem appears to be due to lack of funds to develop and operate efficient data archival and distribution facilities for secondary users.

It is currently impossible to get satellite data archives to copy very large data sets—thousands of tapes—so the 'archive' is basically a warehouse of information with limited distribution capacity.

U.S. Navy

The U.S. Navy has a global marine data collection program that is among the largest in the world. Data collection by the Navy is not necessarily fo-

cused in the U.S. EEZ; therefore it is difficult to estimate how much of the Navy's data relate to the EEZ. The Navy's marine data collection includes bathymetry, subsurface currents, seismic profiles, bottom samples, visibility, some water chemistry and biology, vertical profiles of physical properties (such as temperature, conductivity, and sound velocity), acoustic character, magnetics, gravity, and some side-scan sonar and bottom photography. Most of the data are either classified or under controlled distribution to the Department of Defense or its contractors.

Some data are collected, corrected, and filtered before being archived at the Naval Oceanographic Office; in most cases, the original/raw data are also retained. Analog data are stored in their original form. Most of the data are stored on magnetic tape, some on floppy disks, and some on paper records. Some unclassified oceanographic data are forwarded to NODC, principally through the Master Oceanographic Observation Data Sets, and some unclassified geological/geophysical data, including unclassified bathymetric data, sediment thicknesses, and magnetics are forwarded to NGDC. The Navy is a significant user of unclassified data obtained principally from NODC and from academic laboratories working under Office of Naval Research contracts. Future use of data is expected to remain at about the present level with no particular focus on the EEZ.

Currently, the U.S. Geological Survey's GLORIA data are not subject to classification. NOAA multi-beam depth data, however, are sufficiently detailed that they are now classified as confidential by agreement of the National Security Council, and the Navy has recommended that this classification be upgraded to secret. Although the NOS is continuing to collect multi-beam data, the NOS data are being treated as classified (see next section). No Sea Beam data are currently being forwarded to NGDC from any source, and thus no such data are released in response to requests from foreign countries.

The Navy's Office of Naval Research supports a set of unclassified basic research contracts (mainly with academic institutions) that obtain data in the EEZ. Some of these are: Coastal Dynamics (to improve prediction of coastal ocean environmental

⁴⁴This problem was mentioned by many other agencies and educational institutions and is outlined in the 1982 NRC report *Data Management and Computation*, Vol. 1.

conditions), Coastal Transition Zone Oceanography (to advance understanding of upper ocean dynamics in regions influenced by the proximity of a coastal boundary), and Sediment Transport Events on Shelves and Slopes (to understand the underlying physics of and develop a new predictive capability for sediment erosion). Small amounts of unclassified Navy EEZ data are provided to the NOAA national data centers.

State and Local Governments

Most, if not all, coastal States are collecting and/or managing EEZ data. Though a major share of their needs is being met by national centers, most must obtain some data from other sources (industry, academic laboratories, and their own facilities).

To determine the amount and characteristics of EEZ data being collected and/or managed by coastal States, OTA sent questionnaires to the State geologists (members of the Association of American State Geologists) of the 23 coastal States. Sixteen replied. Analysis of the responses revealed that:

- Roughly 75 percent of State data exist in analog form. Only one (the Oregon Department of Geology and Mineral Industries) collects most of their data in digital form. Approximately 80 percent of the data are stored on paper only.
- The most usual time lag between sampling and reporting was 1 year, ranging from 1 month to 3 years.
- Without exception, those who have data make it available to others. Most of this activity is in response to individual requests.

Problems Handling State Data.—Even where State digital data sets exist, transfer to other users has been difficult because of lack of a standard format. The greatest need expressed by the States is for the establishment of a system to insure a regular exchange of information and to encourage the coordination of activities on local, regional, and national levels.

Academic and Private Laboratories

The academic laboratories vary widely in size, scope, and sophistication. They range from the 10 major oceanographic institutions which are mem-

bers of the Joint Oceanographic Institutions⁴⁵ to the hundreds of smaller coastal and estuarine laboratories. Many of them maintain their own data archives. Those undertaking research sponsored by the NSF Division of Ocean Sciences and and/or located near the five NODC liaison offices (at Woods Hole, Massachusetts; Miami, Florida; La Jolla, California; Seattle, Washington; and Anchorage, Alaska) routinely provide their data to NODC and/or NGDC. About 20 percent of NODC's present archive has come from the academic and private laboratories and recently the annual percentage acquired from them is even greater—42 percent in 1985 and 35 percent in 1986. NODC staff credit the National Science Foundation's Ocean Sciences Division's ocean data policy as a contributing cause to this increase.

Academic and private laboratories respond to the 'market place' in their handling of unclassified oceanographic data. Thus, the solution to data management problems lies with those who control the market, mainly the Federal agency sponsors of academic research. Effective processing of data collected on academic ships may depend on inclusion of funds in the research project specifically for the purpose of data reduction. In NSF, the Division of Ocean Sciences budgets for this activity, but the Division of Polar Programs does not.

Some of the smaller laboratories have minimal involvement in either using or producing EEZ data. Networks for regional data exchange would help to alleviate this barrier.

Industry

Private industry has been a relatively minor source of data for the national archives, amounting to only 4 percent of the total NODC data. However the present annual percentage for NODC increased abruptly to 6 percent in 1985 and then to 14 percent in 1986. NODC staff attributes this increase to recent practices by some government agencies contracting for oceanographic survey work (e.g., MMS) to specify that unclassified data be provided to data centers.

⁴⁵Scripps Institution of Oceanography, Woods Hole Oceanographic Institution, University of Washington, University of Miami, Lamont-Doherty Geological Observatory, Texas A&M University, University of Rhode Island, Oregon State University, Hawaii Institute of Geophysics, and the University of Texas.

OTA surveyed 10 industrial organizations (primarily geophysical firms) actively collecting and/or utilizing EEZ data, with these results:

- About 75 percent of the companies contacted collect all or part of the EEZ data that they use, and almost all of the data are digital. Predominately, the stored data are unaltered and on magnetic tape.
- One major geophysical prospecting company far outstripped the combined total of stored data by all other companies— 10^{14} bytes—amounting to a total of about 2 million reels of magnetic tape. The other companies ranged from a few reporting hundreds of reels of magnetic tape to the remainder utilizing only a few tens of reels.
- Most of the companies make their data available only through purchase. A few reported providing data to national data centers, especially those collecting data for a Federal agency under contract.

- Estimates of future increase or decrease of use were highly variable and were indicated as being sensitive to future economic conditions, particularly in terms of variability of costs of EEZ resources (e. g., oil).

Problems Handling Industry Data.—Government agencies frequently replicate data that private companies have “in-house. Such duplication of efforts is extremely costly. Some industry spokespersons believe that Federal survey programs are unfairly competitive with industry surveys. On the other hand, private industry often retains details related to their surveys as proprietary information. Federal access to details creates an awkward situation in that once survey data are in Federal hands, they can be accessed by others through the Freedom of Information Act. A centralized index of industry surveys similar to the NGDC GEODAS (Geophysical DATA System) system is needed so researchers will know what private sector data exist, thereby avoiding potential duplication.

CLASSIFICATION OF BATHYMETRIC AND GEOPHYSICAL DATA

Multi-beam mapping systems, e.g., Sea Beam and the Bathymetric Swath Survey System—BS³, can produce bathymetric maps of the seabed many times more detailed than single beam echo sounding systems (figure 7-3, for example). This new generation of seabed contour maps approaches—and sometimes exceeds—the accuracy and detail of land maps and provides oceanographers a picture of the deep ocean floor not available a scant decade ago. Prior to 1979, before the first NOAA research vessel *Surveyor* was equipped with Sea Beam, the U.S. oceanographic community only had available low-resolution bathymetric maps that were suitable for navigation and general purposes but lacked the detail and precision needed for science.

Some marine geologists and geophysicists consider the development of multi-beam mapping systems to be their profession's equivalent of the invention of the particle accelerator to a physicist or the electron microscope to a biologist. Now that the technological threshold for sensing the intricate details of the landforms beneath thousands of feet of ocean water has been overcome, oceanographers believe that tremendous strides can be made in ex-

ploring the seabed and understanding the processes occurring at great ocean depths.

The convergence of two advanced technologies—multi-beam echo sounders and very accurate navigational systems—provides the basis for extremely detailed maps of the seabed that are spatially accurate in longitudinal and latitudinal position on the earth's surface as well as precise in determining the depth and landforms of the undersea terrain. Multi-beam systems, when used in conjunction with the satellite-based Global Positioning System, can produce charts from which either surface craft equipped with the same shipboard instruments or submarines with inertial navigation and sonar systems can navigate and accurately position themselves.⁴⁶ If geophysical information, e.g., gravity and magnetic data, is superimposed over the mapped region, its value for positioning and navigation is further enhanced. A 1987 workshop of Federal, private, and academic representatives

⁴⁶R. Tyce, J. Miller, R. Edwards, and A. Silver, “Deep Ocean Pathfinding—High Resolution Mapping and Navigation,” *Proceedings of the Oceans '86 Conference* (Washington, DC: Marine Technology Society, 1986), pp. 163-168.

Figure 7-3.—Map of the Surveyor Seamount Straddling the Juan de Fuca Ridge Produced With Sea Beam Bathymetry

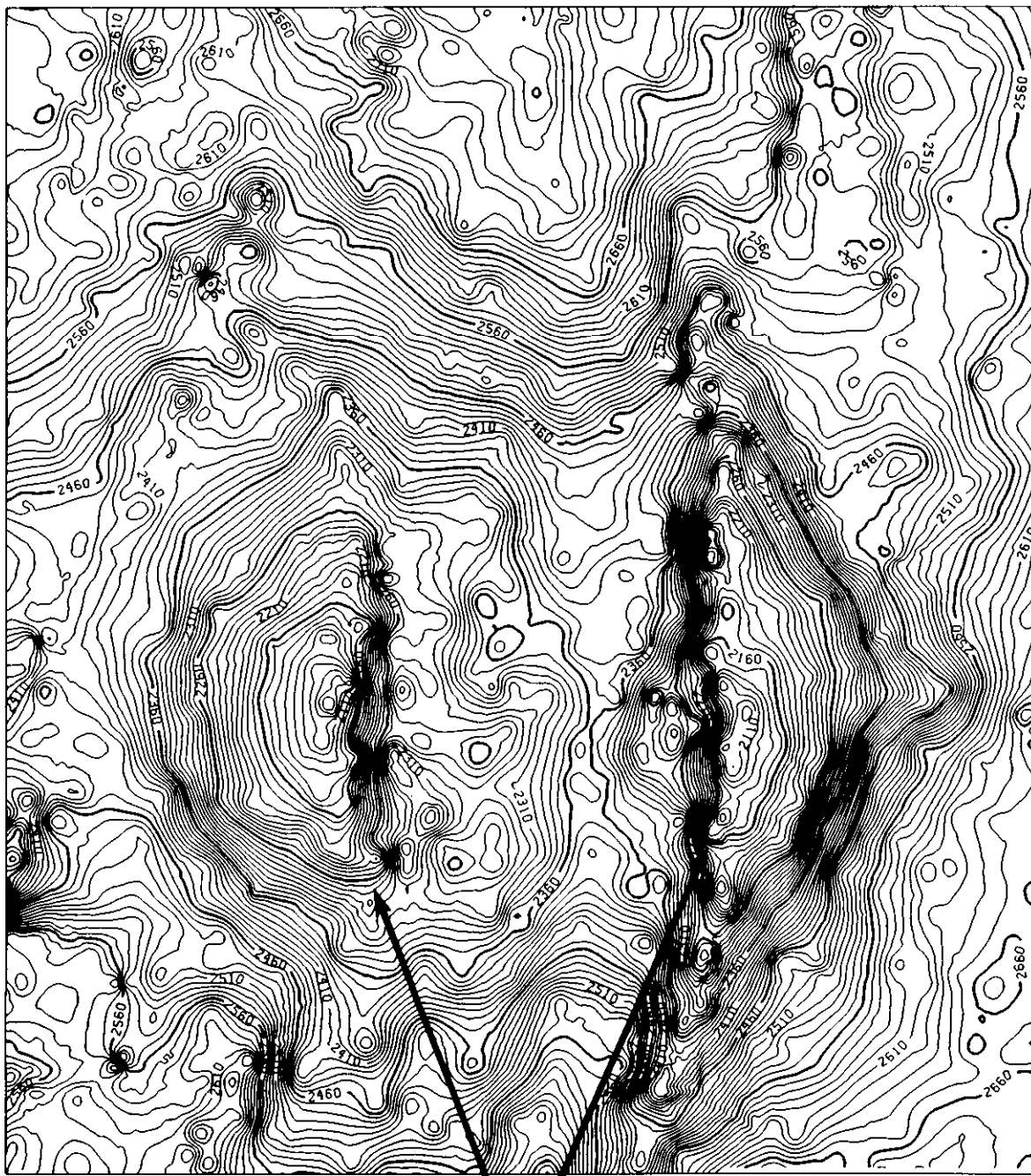

**Two halves of
Surveyor Seamount**

The contours depict water depth in meters. The split in the mountain was caused by seafloor spreading. This map shows only 2 percent of the data (about 400,000 data points) obtained by Sea Beam. The detailed features obtained with Sea Beam encouraged scientists to study this area more closely; evidence of recent volcanism has unexpectedly been found.

Source: National Oceanic and Atmospheric Administration

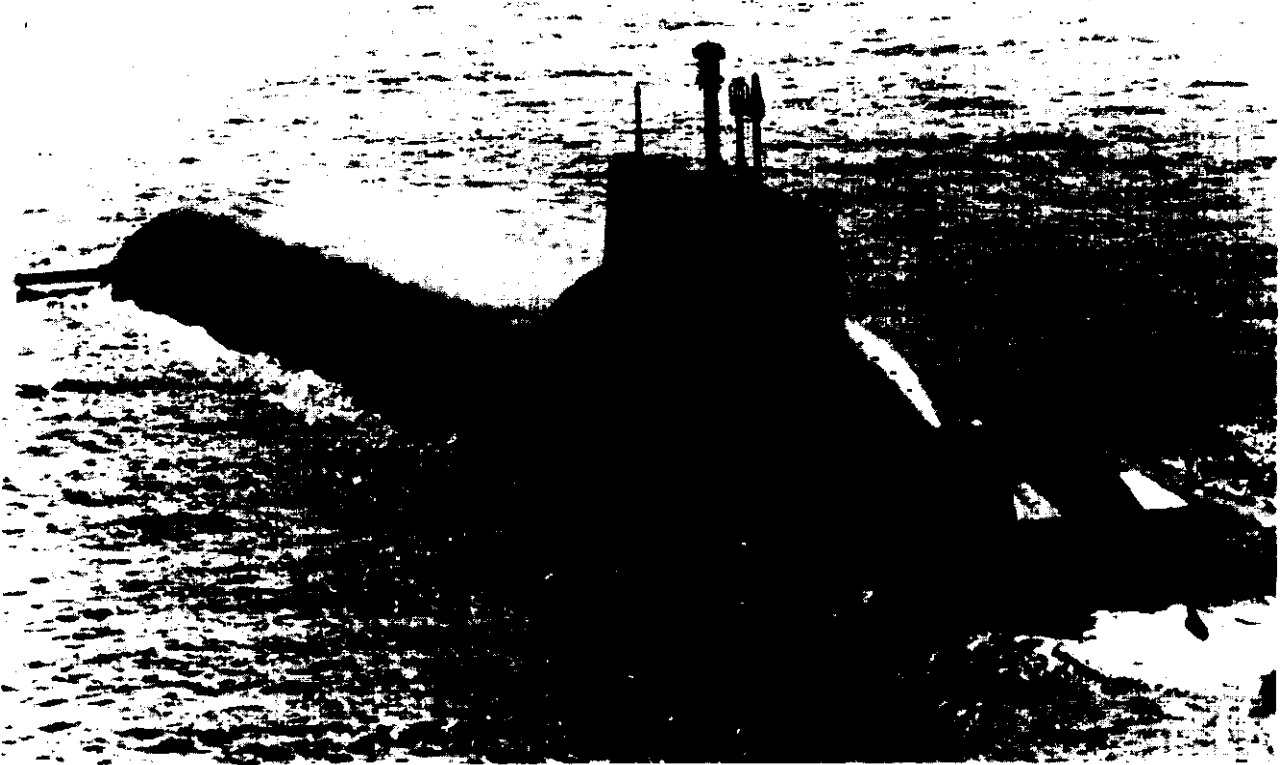

Photo credit: Jane's Fighting Ships, 1985-86

A Typhoon class submarine can operate in any ocean of the world and still have her main targets within range.

concluded that NOAA should acquire geophysical data that would not hinder the timely acquisition of the bathymetric data.⁴⁷ Classification stymied NOAA's effort to form a cooperative arrangement with industry and academia. Thus, to date, NOAA has not acquired gravity or magnetic data.

While the capability to identify subsurface terrain features and accurately determine their position is a boon to scientists seeking to locate and explore geological features on the seafloor, it presents a potentially serious security risk if used by hostile forces. Because of the security implications, the U.S. Navy, with the concurrence of the National Security Council's National Operations Security Advisory Committee, initiated actions to classify multi-beam data and restrict its use and distribution.

⁴⁷The OTA Workshop on Data Classification was held Jan. 27, 1987, at Woods Hole Oceanographic Institute, under the auspices of the Marine Policy and Ocean Management Center.

Modern undersea warfare requires that submarines, once submerged, remain submerged to avoid detection. When submarines operate globally, this long-term submergence presents significant navigational problems. Inertial guidance systems and other navigational gear must be occasionally updated with precise locational information if the submarine's position is to be determined accurately. One means for doing this is by fixing terrain features on the ocean bottom and triangulating within them to determine the vessel's position. With detailed bathymetric maps and precise geodesy, modern acoustical detectors and onboard computers are capable of precisely fixing a submarine's position without having to surface and risk detection. Little imagination is needed to understand the security implications of high-resolution bathymetry. Bathymetric data may also affect other aspects of undersea warfare, including acoustical propagation and mine warfare countermeasures.

In 1984, NOAA centered its bathymetric data collection in the NOAA ship Surveyor (equipped

with a Sea Beam system) and the *Davidson* (equipped with BS³) and announced long-range plans to systematically map the U.S. EEZ. NOAA's plans for comprehensively mapping the EEZ at a high resolution—depth contours of 10-20 meters, and geodetic precision of 50-100 meters—have been challenged by the Navy, and the two agencies have since entered into protracted negotiations in search of a workable solution, but in the summer of 1987 significant problems remained unresolved.⁴⁸

Marine scientists and private commercial interests are concerned that the Navy may classify NOAA bathymetric and geophysical data. Whenever data classification is at issue, the reasons for the security restrictions themselves are considered sensitive, thus opportunities are limited for public review of the need and extent of restrictions or for consultation to identify possible compromises to balance security risks and scientific needs. In general, both the oceanographic community and private industry have not been involved in the negotiations between NOAA and the Navy to the degree that the non-government interests believe they should be, given their stake in the outcome of the classification decision. Even some scientists within NOAA feel alienated from the process.

Earlier Reviews of Data Classification

In 1985, the Director of the White House Office of Science and Technology Policy requested that the National Academy of Sciences (NAS) review the National Security Council's position that public availability of broad-coverage, high-resolution bathymetric and geophysical maps of the EEZ would pose a threat to national security; NAS was asked to explore plausible means to balance national security concerns with the needs of the academic and industrial communities. In the course of its study, the NAS Naval Studies Board found it impossible to "quantify" national security benefits gained from classification or the possible benefits that could be realized by the U.S. scientific and industrial users if such data were to be freely available to the public.

⁴⁸Letter from Anthony J. Calio, Administrator, NOAA, to Rear Admiral John R. Seesholtz, Oceanographer of the Navy, Feb. 3, 1986; and reply from Seesholtz to Calio, Mar. 14, 1986. An extensive exchange of correspondence followed between Calio and Seesholtz through Nov. 6, 1986.

Because of the difficulty it encountered in evaluating the benefits and risks associated with classifying bathymetric and geophysical data, the Naval Studies Board restricted its inquiry to whether the unrestricted release of accurately positioned, high-resolution bathymetric data could result in any new and significant tactical or strategic military threats. It did not assess the needs of the oceanographic and geophysical research community for the data, nor did it assess the ocean mining industry's need for such surveys. The Naval Studies Board concluded that "map matching, i.e., locating one's position by matching identifiable features on the seafloor by using precise bathymetry from broad regional coverage, could afford potentially hostile forces a unique and valuable tool for positioning submarines within the U.S. EEZ.

While the Naval Studies Board supported the Navy's position with regard to classifying and controlling "processed" survey data, it did not favor classifying raw data until they are processed into a form that provides full geodetic precision and large area coverage. As a further measure, the Board suggested that each processed map be reviewed for distinctive navigational features that would make it valuable for precise positioning and that the sensitive data be "filtered" as necessary to permit its use in unclassified maps. The Board further recommended that the sensitive data be made available on a classified basis to authorized users and that raw data covering a limited area be released without security restrictions for the pursuit of legitimate research.⁴⁹

A second review of the Navy's data classification policy regarding multi-beam data was also undertaken by the National Advisory Committee on Oceans and Atmosphere (NACOA) at the request of NOAA in 1985. NACOA generally supported the Naval Studies Board's conclusions, and found the national security argument for classifying high-resolution bathymetric data made by the Navy more "compelling" than the counterargument made by the academic community for free exchange of scientific information.⁵⁰ NACOA therefore rec-

⁴⁹Naval Studies Board, *National Security Implications of U.S. Exclusive Economic Zone Survey Data*, (Washington, DC: National Research Council, Mar. 25, 1985), p. 6.

⁵⁰National Advisory Committee on Oceans and Atmosphere, *NACOA Statement on the Classification of Multibeam Bathymetric Data* (Washington, DC: National Advisory Committee on Oceans and Atmosphere, Jan. 17, 1986), p. 4.

ommended that only "controlled selective dissemination" of NOAA's multi-beam data be allowed. A detailed investigation of areas up to 20 nautical miles square; and

Analyzing the two public reports of the Naval Studies Board and NACOA, OTA found that neither group, in reaching its conclusions, appears to have fully weighed the risks, costs, and implications of withholding most high-quality bathymetric maps from the academic community and the private sector. Furthermore, neither report seems to acknowledge the extent that multi-beam technology has proliferated throughout the world among the academic, commercial, and government entities of both friendly and potentially hostile nations. As multi-beam survey data becomes more widely available, secure navigation is possible without NOAA data. Many foreign countries, including the Soviet Union, are now operating multi-beam survey systems. Additionally, there has been no restriction placed on data produced by U.S. academic research vessels operating Sea Beam systems. Finally, neither report discusses the possible inconsistency between the restricted use of broad-coverage, high-resolution bathymetry by U.S. scientists and the private sector and the U.S. position regarding international principles of freedom of access for scientific purposes in other nations' EEZs and foreign scientists' access to the U.S. EEZ.

NOAA's Survey Plans—Navy's Response

After the release of the Naval Studies Board and NACOA reports in March 1986 and June 1986 respectively, the positions of NOAA and the Navy on multi-beam classification diverged rather than converged toward a solution. In response to the Navy's opposition to allowing NOAA to proceed with comprehensive unclassified multi-beam coverage of the EEZ that might serve as an atlas of the seabed, NOAA proposed to abandon its comprehensive long-range plan and substitute a series of smaller-scale targets for multi-beam surveys. These smaller-scale targets included:

- specific sites in water depths greater than 200 meters;
- continuous coverage surveys in limited areas of concern, e.g., estuarine areas and for navigational safety in depths of 200 meters or less;
- widely-spaced reconnaissance swaths over the extent of a seabed feature;

international waters outside the U.S. EEZ consistent with international law in a manner similar to multi-beam surveys made by the domestic and foreign academic fleets.⁵¹

The Navy formed a working group to address NOAA's proposal. The working group concluded that

Surveys in waters shallower than 200 meters along the U.S. coastline are particularly sensitive and should be restricted and classified. Bathymetric data on survey sheets that allows positions to be fixed to less than one-quarter nautical mile should be classified secret; therefore, based on tests showing that a significant proportion of NOAA's multi-beam surveys fall into this category, the Navy proposed that all multi-beam data be collected, processed, and held at the secret classification.

Navigation and bathymetric data either must be shipped separately to secure onshore facilities, or if combined (which NOAA does to maintain quality control), it must be handled under secret classification.

Areas outside the U.S. EEZ that NOAA proposes to survey may still be sensitive since they could pose a threat to allies and therefore should come within the classification scheme.

Small "postage stamp" (20 by 20 nautical miles) surveys also should be considered classified. The Navy did allow that accurate and reliable unclassified nautical charts with appropriate contour spacing can be produced from the classified database to support NOAA's nautical charting mission.⁵²

The Navy is continuing to work on filtering techniques that would distort (degrade) the shape and/or the location of seabed features. Distortion would reduce the usefulness of a survey sheet for vessel positioning but would allow NOAA to distribute survey sheets in unclassified form to all users. Efforts to date have not produced a filter that can

⁵¹ Letter from Anthony J. Calio, Administrator, National Oceanic and Atmospheric Administration, to Rear Admiral John R. Seesholtz, Oceanographer of the Navy, Feb. 3, 1986.

⁵² Letter from Rear Admiral John R. Seesholtz, Oceanographer of the Navy, to Anthony J. Calio, Administrator, National Oceanic and Atmospheric Administration, Oct. 6, 1986.

satisfy both the security demands and positional criteria established by the Navy while still providing oceanographers and the private sector with sufficiently detailed information to be useful. The prospects of developing a mutually acceptable filter seem remote.

OTA Classification Workshop

In collaboration with the Marine Policy and Ocean Management Center of the Woods Hole Oceanographic Institution, OTA convened a workshop in Woods Hole, Massachusetts, in January 1987. Academic and government oceanographers and industry representatives who attended delved further into the impacts and dislocations that data classification might impose on user groups. Workshop participants were asked to:

- focus on the costs and risks of classification to scientific and commercial interests,
- relate the loss of information and/or commercial opportunities in the EEZ to the economic and scientific position of the United States,
- consider the consequences of data classification on U.S. foreign policy related to the need for access to other Nations' EEZs for oceanographic research, and
- identify factors that could affect the operational integrity of a Navy classification system.

Costs and Risks to Scientific and Commercial Interests

Marine geologists and geophysicists believe that it is impossible to evaluate what the loss might be to the U.S. oceanographic community as a result of classifying multi-beam data until a sufficiently large area is surveyed and mapped to discover what scientifically interesting features might be detected as a result of high-resolution bathymetry. The relatively small sampling that has been made available to date receives high praise from the academic community and government oceanographers who anticipate significant breakthroughs in understanding the conformation of the seabed if general-coverage multi-beam data are made available from the EEZ.

To advance oceanographic science, some scientists believe that they must be able to detect and characterize individual geological seafloor features

with dimensions as small as 100 meters. Only multi-beam mapping systems provide sufficient resolution to achieve that goal in waters exceeding 200 meters in depth, although optical systems and side-scanning sonar can provide useful information about such features. Should broad-coverage, high-resolution bathymetric surveys and geophysical data be either abandoned or excessively restricted, geologists and geophysicists are concerned that they would be denied fundamental information important to their professions, according to those attending the OTA workshop.

Both NOAA's and the National Science Foundation's (NSF) charters require them to share and publicly disseminate scientific data among non-governmental users. Oceanographic data collected under the aegis of NSF's Division of Ocean Sciences is required to be made public after two years through a "national repository, e.g., the National Geophysical Data Center (NGDC). As a consequence of classification of multi-beam data, there is a possibility that neither NOAA nor NSF would support or undertake large-scale seabed mapping efforts. NOAA has reserved the option of terminating all multi-beam surveys if it is not permitted to conduct unclassified surveys in the U.S. EEZ and elsewhere. ⁵³ Should NOAA forsake broad coverage multi-beam surveys worldwide, the Navy itself would likely lose a valuable source of strategic and tactical bathymetric data from both the U.S. EEZ and elsewhere that could strengthen the U.S. fleets' operational position.

One anticipated indirect long-term impact that could result from restrictions on the collection, processing, and dissemination of multi-beam bathymetric data is a move away from academic emphasis on marine geology and a slowdown in progress in understanding the seafloor and geological processes. Ocean mining interests foresee setbacks in extensive mineral surveying within the U.S. EEZ if NOAA is restricted in its unclassified mapping program. Some industry representatives believe that seabed mining holds a special position of national importance, and, therefore, even if classification procedures were imposed, ocean miners should be given access to the classified, "undegraded," high-resolution bathymetric data. Yet, while Federal

⁵³ *Ibid.*

agencies with properly cleared personnel will have access to the multi-beam data, it is uncertain whether or not private firms can have similar access. Some firms can handle classified data, but others cannot. Firms that can access such data would have a significant advantage in the bid process. It remains to be seen as to whether or not industry will tolerate such a disparity.

Since the NOAA mapping program is currently the only one affected by the threat of classification, it remains possible for individuals to contract with domestic and foreign firms to conduct multi-beam surveys in the U.S. EEZ. International law does not preclude the conduct of such surveys within the EEZ. Permission is required only when surveys fall within the Territorial Sea. A West German survey ship has already conducted surveys within the U.S. EEZ in cooperation with U.S. industry. Broad-coverage bathymetric surveys would be expensive, and, given the many other uncertainties facing the domestic ocean mining industry, e.g., unstable minerals markets, high cost of capital, and regulatory uncertainties, it is unlikely that mining ventures would commit the necessary funds to contract for such reconnaissance multi-beam surveys, thus reducing the likelihood that mine sites would be developed successfully. Security restrictions on multi-beam data will affect a number of other undersea activities as well, e.g., submersible operations, modelling, identification of geological hazards, cable and pipe routing, fishing, etc.

Through July of 1987, there were no classification restrictions placed on multi-beam bathymetry collected and processed by the academic fleet. However, the Navy has given no assurances that academic data will not be classified in the future. With the exception of surveys made of the Aleutian Trench in the Pacific Ocean and Baltimore/Wilmington Canyons in the Atlantic Ocean, seldom do academic vessels undertake broad bathymetric coverage; rather, they tend to concentrate on smaller specific units of the seafloor. Most of the surveys made by the academic fleet have been made outside the U.S. EEZ. On the other hand, if funds were made available, it may be possible to mount a cooperative broad-scale mapping effort among at least three world-class oceanographic research vessels in the U.S. academic fleet that are equipped

with multi-beam systems to provide high-quality data with atlas coverage.⁵⁴

Impacts on U.S. Economic and Scientific Position

Commercial interests represented at the OTA workshop in Woods Hole suggested that restrictive classification procedures could chill the development of new echo sounding technology, since domestic civilian markets for such instruments would probably disappear. Should this situation arise, foreign instrument manufacturers are likely to displace U.S. firms in international markets, and the predominance established by the United States in the 1950s and 1960s would give way, with the leading edge of acoustical sounding technology (much of which was sponsored by the Department of Defense) being transferred overseas. To some extent, this has already happened. There is also a risk that as other nations allow unclassified multi-beam bathymetric maps to be produced within their EEZ, U.S. ocean mining firms, most of which are multinational, might find it advantageous to locate mining ventures in foreign economic zones and abandon efforts in the U.S. EEZ. At a minimum, classification may drive U.S. firms into multinational agreements in order to acquire needed data within the U.S. EEZ.

International scientific competition is fierce. This fact is seldom fully appreciated by those unfamiliar with the science establishment. Oceanographers attending the OTA Woods Hole workshop were uniform in their belief that U.S. marine geologists and geophysicists would be put at a disadvantage with their foreign colleagues who may not be limited by data classification. This might tend to lure U.S. researchers to focus their efforts elsewhere in the world where there are fewer constraints on the use and exchange of multi-beam and geophysical data, thus depriving the United States of the benefit of research within its own EEZ.

There was general agreement at the OTA Woods Hole workshop that, if faced with the alternative

⁵⁴ The research vessel *Thomas Washington* operated by Scripps Institution of Oceanography and the research vessels *Robert Conrad* and *Atlantis II* operated by Lament-Doherty Geological Observatory and Woods Hole Oceanographic Institution respectively.

of having high-resolution multi-beam data that has been “degraded” or “distorted” by filters and algorithms, the oceanographic community would prefer to continue using the best “undoctored,” unclassified data available even if it were of lower resolution. If the choice of having high-resolution multi-beam bathymetric data over a small area is weighed against broad coverage with filtered data, most oceanographers prefer limited coverage and high-resolution.

Foreign Policy Implications of Data Classification

In proclaiming the establishment of the U.S. Exclusive Economic Zone (EEZ) in 1983, President Ronald Reagan carefully specified that the newly established ocean zone would be available to all for the purpose of conducting marine scientific research.⁵⁵ The President’s statement reaffirms a long-held principle of the United States that it maintained throughout the negotiations of the Law of the Sea Convention (LOSC): notwithstanding other juridical considerations, nations should be free to pursue scientific inquiry throughout the ocean.

Although signatories to the LOSC granted the coastal states the exclusive right to regulate, authorize, and conduct marine research in their exclusive economic zones, the United States—a non-signatory to the LOSC—continues to support and advocate freedom of scientific access.⁵⁶ Thus, although other nations may impose consent requirements on scientists entering their EEZs if they view such surveys as counter to their national interest, the United States has no such restrictions.

While oceanographers are generally pleased with the U.S. open door policy for scientific research in the EEZ, those attending the OTA Woods Hole workshop see potential problems if the Navy establishes precedence for classifying high-resolution bathymetric maps for national security reasons. If the Navy continues to prevail in its position on the sensitivity of multi-beam data, then the United States might find it necessary to prohibit or control the acquisition and processing of similar data by foreign scientists. Such action would, for prac-

tical purposes, repudiate the President’s announced policy of free access to the EEZ for scientific research.

Should multi-beam bathymetry in the U.S. EEZ be classified, many oceanographers believe that other countries would follow suit or retaliate against U.S. scientists by placing similar restrictions on the collection and processing of data within their EEZs. To date, no foreign multi-beam data has been submitted to NGDC. Other countries are waiting to see how the security issue is resolved within the U.S. The consequences for marine geological and geophysical research on a global scale could be severe as a result of removing a significant portion of the world’s seafloor from investigation. The withdrawn areas would include much of the continental margins that are scientifically interesting and may also contain significant mineral resources.

Will Classification Achieve Security?

Although the National Security Council and the Navy may effectively derail NOAA’s plans for comprehensive coverage of the U.S. EEZ by high-resolution multi-beam mapping systems, the action in no way assures that such data can not be obtained by a potential hostile through other means. Broad-coverage multi-beam data could be collected and processed by non-government sources, and accurate, unclassified bathymetry could be acquired for strategic and tactical purposes. It is also possible that foreign interests could gather such data and information either covertly under the guise of marine science or straightforwardly in the EEZ under the U.S. policies related to freedom of access for peaceful purposes—although the latter approach might prove politically difficult.

The Navy, on the other hand, considers that any action it may take to gather bathymetric information using its own ships is by definition *not* conducting marine scientific research, but conducting “military surveys for operational purposes” which are therefore not subject to coastal State jurisdiction as are civilian scientific vessels gathering the same kind of information.⁵⁷ Because the Navy con-

⁵⁵Statement by the President accompanying the proclamation establishing the U.S. Exclusive Economic Zone, Mar. 10, 1983, p. 2.

⁵⁶United Nations Law of the Sea, Part XIII, Sec. 3, Art. 246.

⁵⁷“Navy Oceanography: Priorities, Activities and Challenges,” speech presented by Rear Admiral John R. Seesholtz, Oceanographer of the Navy, Center for Oceans Law and Policy, University of Virginia, Charlottesville, Virginia, Oct. 24, 1986.

siders its operations using multi-beam bathymetric systems to be "hydrographic surveying" rather than scientific research, it remains possible for other foreign navies to make the same claim to gain access to the U.S. EEZ for similar purposes.

Over 15 vessels are known to be equipped with multi-beam mapping systems worldwide, not including those of NOAA and the Navy. Multi-beam mapping systems, while expensive to purchase and operate, are not a technology unique or controlled by the United States. Multi-beam technology is shared by France, Japan, United Kingdom, Australia, Federal Republic of Germany, Finland, Australia, Norway and the Soviet Union. (Canada is now in the process of purchasing a system.) While several multi-beam systems were purchased from U.S. manufacturers, other countries, e.g., Federal Republic of Germany (two companies), Finland, and Norway, developed their own systems.

Multi-beam technology is not new. The first Sea Beam unit outside a U.S. Navy vessel was installed on an Australian naval vessel the HMS *Cook*, in 1976 and the second on the French vessel *Jean Charcot* in 1977. The technology is over 20 years old. While oceanographers are reluctant to consider Sea Beam as "obsolete" or "outmoded," they note, however, that better technology has been developed and is available in the world market.

Export licenses have been denied to U.S. manufacturers of multi-beam systems for sale to Brazil and Korea for security reasons, but comparable echo sounding equipment is available from foreign sources. U.S. restrictions on the export of multi-beam systems put U.S. equipment manufacturers at a disadvantage. Since foreign multi-beam manufacturers exist, current U.S. policy on technology transfer does not effectively limit the availability of these systems to foreign purchasers. Foreign firms have interpreted U.S. policy to mean that they are not restricted from collecting multi-beam data in the U.S. EEZ. Moreover, operating only within the domestic market, U.S. manufacturers find it difficult to remain competitive.

Private commercial firms have recently announced their intent to enter the multi-beam service market, offering contract arrangements for acquiring, logging and processing high-resolution bathymetric data; and perhaps to recover geophysi-

cal data as well. It is apparent that restricting and controlling the acquisition and dissemination of high-quality bathymetric data will become more difficult in the future as its commercial value increases. Just as geophysical surveying firms have been formed to respond to the offshore petroleum industry's need for seismic survey data, so too may bathymetric survey firms respond to an increased demand for multi-beam data. New survey systems that combine wide swath bathymetric measurements with side-scan sonar imagery, e.g., SeaMARC, are also available in the commercial fleet.

Some oceanographers believe that a large amount of unclassified bathymetric data and charts of sufficient precision and accuracy to be used for strategic and tactical purposes are already in the public domain and that much of it may have to be classified if subjected to the Navy's positioning tests. For example, many of NOAA's single-beam surveys that are run with precise electronic control and close line spacing for charting coastal areas and harbor approaches have resolution comparable to multi-beam surveys and are currently in the public domain. A considerable amount of similar commercial data has also been collected and is available for sale. A potential adversary would only need selected data sets to complicate a warfare situation.

The current move to classify bathymetric data is not the first time data restrictions have been imposed on the oceanographic community. From the end of World War II in 1945 to well into the 1960s, some bathymetric data collected in deep ocean areas by the single-beam systems were also classified. One difference between now and then is that earlier surveys were either made by Navy vessels or procured by Navy contract; there was no drain on civilian research and survey budgets, hence little proprietary claim for access to the data could be made by civilian interests.

Observations and Alternatives

Dealing from its position of power regarding security matters, the Department of Defense appears not to have opened the doors of inquiry wide enough to allow adequate involvement of the scientific and commercial communities. Even in its dealings with NOAA, the Navy leaves an impres-

sion among civilian officials that it can maintain its control by not sharing important information germane to the issue, such as technical limits of its requirements. At the same time, the Navy appears to be skeptical about the scope of claims made by civilians on their need to access multi-beam data. Whether facts or perceptions, the current debate is rife with concerns that must be overcome if a mutual solution is to be reached.

While much of the current debate has centered on Sea Beam data because of NOAA's plans to extensively map the EEZ, the Navy has proposed to restrict other multi-beam surveys and geophysical monitoring as well, e.g., magnetic and gravity data. Proposals have been made that NOAA collect geophysical data concurrently with bathymetric data.⁵⁸ Such multiple sensing could enhance the scientific usefulness of bathymetric surveys, and it also could increase the usefulness of data for positioning submarines.

Thus far, scientific and commercial interests have resisted the proposed use of mathematical filters to distort the shape and location of subterranean features. One option they have discussed is the establishment of secure processing centers to archive bathymetric and geophysical data. Appropriately

cleared researchers could then have access to classified data and secure processing equipment to meet scientific and commercial needs. A similar option would be to allow secure facilities to be located at user installations. A significant amount of classified material is handled by civilian contractors under supervision of DOD. Similar arrangements may be possible with appropriately cleared users of bathymetric/geophysical data. However, a major problem exists in that we are now in a 'digital world, and secure processing of digital data is both expensive (site security) and restrictive (no networking of computers). Universities and firms typically have linked computers and may have to submit to the added expense of additional systems to handle these data. Other innovative means to manage the difficult problems of balancing national security with data access may be possible.

Acceptable resolution of the debate over classifying multi-beam bathymetric data will require more candor and a better exchange of information on all sides of the issue. The Navy appears to have done an insufficient job of communicating its needs and reasons for classification. On the other hand, the scientific community also has had difficulty in articulating its reasons for needing high-resolution bathymetry and in backing them with solid examples. Satisfactory solutions will only come by including in the classification debate those with a stake in the academic and commercial use of bathymetric and geophysical data.

⁵⁸National Oceanic and Atmospheric Administration, *Report of the NOAA Exclusive Economic Zone Bathymetric and Geophysical Survey Workshop*, Dec. 11-12, 1984, p. 2.

Appendixes

State Management of Seabed Minerals

State Mining Laws

All States bordering the territorial sea have statutes governing exploration and mining on State lands, including offshore areas under State jurisdiction. The statutes range from single-paragraph general authorizations, equally applicable on land or water, to detailed rules specifically aimed at marine exploration and mining. Some States provide separate rules for petroleum and hard minerals. These laws are outlined in table A-1, which only includes laws affecting mining activities. The States also have water quality, wildlife, coastal zone management, administrative procedure, and other laws that might affect seabed resource development.

There are large differences among the State mining laws, making a typical or model mining law difficult to describe. A review of the coastal States' mining laws does reveal some common characteristics that suggest different ways to achieve each objective.

Scope:

Many States do not separate onshore from offshore development, thus providing a single administrative process for all mineral resources. At least four States (California, Oregon, Texas, and Washington) distinguish oil and gas from hard minerals.

Exploration:

Most States have general research programs, carried out by geological survey offices or academic institutions. Some States provide for more detailed state prospecting in areas proposed for leasing. Private exploration generally requires a permit.

Area limits are unspecified in most statutes. Land-oriented statutes tend to require smaller tracts, Alaska limits permits to 2,560 acres but allows a person to hold multiple permits totalling up to 300,000 acres.

Prospecting permits may be general or for designated tracts. Alaska, California, Texas, and Washington grant exclusive permits while Delaware, Florida, and Oregon do not. Permits may also specify the type of mineral being sought.

California and Washington grant a preference-right lease to prospectors making a discovery. Delaware and Oregon do not. Other States, including Alaska, Maine, New Hampshire, and Texas, allow all or part of the explored area to be converted to a mining lease upon discovery of commercial deposits.

Exploration results must be reported to the State but their confidentiality is protected for the duration of the prospecting permit and any subsequent lease. Massachusetts requires survey results to be made public prior to the hearing concerning the granting of a lease.

The duration of prospecting permits is generally 1 or 2 years with renewal terms ranging from 1 year to indefinite. Alaska provides a 10-year prospecting term.

Annual rents range from \$0.25 per acre in Texas and Washington, to \$2.00 per acre in California, and \$3.00 per acre in Alaska. Maine has a sliding scale, increasing from \$0.25 per acre in the first year to \$5.00 per acre in the fifth.

Mining Lease or Permit:

Some States grant preference-right leases or allow conversion. Competitive bidding is the general basis for awarding leases with a cash bonus, or royalty, or both being the bid variable. California also allows bidding on "net profit or other single biddable factor. Some States grant leases noncompetitively, conducting an administrative review of individual lease applications. Public hearings are usually required under all of these systems.

Most States do not specify area limits for mineral leases. Where conversion is allowed, a prospector may only convert as much land as is shown to contain workable mineral deposits or as much as he can show himself capable of developing. Where limits are specified, they range from 640 acres (Washington) to 6,000 acres (Mississippi). States limiting the acreage covered by each lease generally do not limit the number of leases that a single person may hold.

Lease terms range from 5 years (Virginia) to 10 years (Delaware, Georgia, North Carolina, Oregon) to 20 years (Alaska, California, Texas, Washington). Renewal is available, usually for as long as minerals are produced in paying quantities. Leases are generally assignable in whole or in part, subject to State approval.

Most States require a minimum rent, credited toward a royalty based on production. Minimum annual rents range from \$0.25 per acre in Delaware to \$3.00 per acre in Alaska. Minimum royalties vary from 1/16 of production in Texas to 3/16 in Mississippi. Louisiana provides different royalties for different minerals, ranging from 1/20 to 1/6 of production. *Some* States provide for payment in kind.

The use of leasing income varies greatly. Among other purposes, it may be allocated to the general fund,

Table A-1.—State Mining Laws

State	Agency	Exploration	Mining permit	Environmental protection	Conflicting uses	Current or past activity	Comments	Statutes and regulations
Alabama	Department of Conservation & Land Resources, State Lands Division	Not specified.	Competitive bidding, tracts up to 5,200 acres.	Bids must be made in the public interest.	Not specified.	Oil and gas leases. No hard minerals.		Ala. Code §9-15-18 (1980).
Alaska	Department of Natural Resources, Lands Division	Exclusive permit up to 5,200 acres, 10-year term. \$3.00 per acre for first two years, \$3.00 per acre each successive year. 300,000-acre limit on permits held by one person.	May be granted non-competitively to holder of prospecting permit for as much land as is shown to contain workable deposits, not to exceed 100,000 acres. Known mineral lands offered by competitive bid/cash bonus, annual rent \$3.00 per acre with credit for expenditures benefiting property. 20-year term, renewable.	Approval from Fish and Game Dept. required	When not otherwise limited by law, nonexclusive use of unoccupied submerged lands shall not be denied to any citizen or resident.	Pilot mining for gold in marine placers off Nome took place in 1985 and 1986. Full-scale mining is planned for 1987. Formerly extensive dredging of shell deposits for cement, now exhausted. No current commercial activity other than oil and gas.		Alaska Stat. §38.05.250 (1984). Alaska Admin. Code tit. 11 ch. 62 (Jan. 1981).
California	State Lands Commission	Exclusive permit on unexplored land, two-year term, renewable for one year. Annual rental of \$2.00 per acre.	Holder of prospecting permit entitled to preference in obtaining a lease. Known mineral lands leased by competitive bid on cash bonus, royalty rate, profit share or other single biddable factor. Minimum annual rent \$1.00 per acre. Twenty-year term, renewable for 10-year terms. No size limit.	All leases must comply with environmental impact report requirements.	Leases may not "substantially impair the public rights to navigation and fishing or interfere with the trust upon which the lands are held."	A few prospecting permits have been issued, but no discoveries have been reported. Some interest in sand and gravel, but no active mining.		Cal. Pub. Res. Code §§6371 and 6890 to 6900 (West 1977) (supp. 1985). Cal. Admin. Code tit. 2552200 to 2205.

Table A-1.—State Mining Laws-Continued

State	Agency	Exploration	Mining permit	Environmental protection	Conflicting uses	Current or past activity	Comments	Statutes and regulations
Connecticut	Department of Environmental Protection, Water Resource Unit	Not specified.	Permit required for taking material from tidal or coastal waters. Payment required if material used for commercial purpose. Hearing required unless environmental impact not significant. Bond for damage.	“due regard for the prevention and alleviation of shore erosion, the protection of necessary shellfish grounds and fin fish habitats, the preservation of necessary wild-life habitats.”	Must consider development of adjoining uplands, rights of riparian owners, navigation facilities.	None at present time.		Corm. Gen. Stat. Ann. §§22a-383 to 22a-390 (West 1985).
Delaware.	Department of Natural Resources and Environmental Control	Non-exclusive permit, two year term, renewable. No preferential right to lease.	Feasibility of leasing determined after a public hearing. Competitive bid/cash bonus. Primary term of 10 years, continued for as long as production takes place. Maximum area six square miles. Minimum royalty 12.5%, with credit for rent paid. Minimum rent \$.25 per acre. Production must begin within three years of discovery of paying quantity of minerals.	Prior to inviting bids, state must consider whether leasing would create air, water, or other pollution.	State must consider any detriment to people owning property or working in the area, interference with residential or recreational use, esthetic and scenic values of coast, interference with commerce and navigation. State may allow reasonable, non-conflicting uses of lease area.	Some oil and gas exploration is starting. Some inquiries but no activity with hard minerals.	Very detailed statute. Requires consideration and balancing of conflicting interest.	Del. Code Ann. tit. 7 ch. 61 (1983).
Florida	Department of Natural Resources, State Lands Division and Bureau of Geology	Nonexclusive use agreement and geophysical testing permit required. One-year term, renewable for second year.	Lease required for exploration and development, competitive bid/cash bonus.	Coastal waters managed primarily for natural conditions and propagation of fish and wildlife. Adverse activities allowed only if there is no reasonable alternative and adequate mitigation is proposed.	Recreation, fishing, and boating are primary uses. Compatible secondary uses may be allowed if they do not detract from or interfere with primary uses.	Sand and shell extraction on a small scale. A mineral survey of Gulf waters is underway.	Recent applications for oil, gas, and mineral exploration permits prompted a adoption of marine prospecting rules in early 1987.	Fla. Stat. Ann. §253.45 (West, 1975). Fla. Admin. Code ch. 16C-26, 16Q-21, & 18-21.

Table A-1.—State Mining Laws—Continued

State	Agency	Exploration	Mining permit	Environmental protection	Conflicting uses	Current or past activity	Comments	Statutes and regulations
Georgia	State Properties Commission	State may enter into contract for exploration without competitive bidding. State inspects or surveys land it desires to lease.	Competitive bid, minimum royalty is 1/8 of production, Minimum annual rent rises from \$.10 per acre in the first year to \$1.00 per acre in the fourth and subsequent years. Primary lease term is 10 years.	As far as practicable, prevent pollution of water, destruction of fish, oysters, and marine life.	As far as practicable, prevent obstruction of navigation.	Some extraction on inland waterways but none offshore.		Ga. Code Ann. §50-16-43 (1965).
Hawaii	Land Management Division, Board of Land and Natural Resources	Permit required. No minerals may be removed beyond quantity needed for testing and analysis. Logs and assays turned over to State but kept confidential. Information may be released if permittee does not apply for a lease within six months.	Granted at public auction following public hearing. Term of 65 years or less at Board's discretion. Mining to commence within three years of signing lease, but lease may allow for an additional period during which lessee is required to spend money on research and development to establish economical mining and processing methods for the deposit. Not more than four square miles per lease, but no limit on number of leases held by one person.	Leases must "comply with all water and air pollution control laws"	Applications for mining leases shall be disapproved if the State determines that the existing or reasonably foreseeable future use would be of greater benefit to the State than proposed mining.	No present ocean mining within State jurisdiction. The draft EIS for a proposed marine mineral lease sale was issued by a State-Federal Manganese Crust Work Group in early 1987.		Hawaii Rev. Stat. ch. 182 (1968) 1986 Hawaii Sess. Law 91 (Ocean and Submerged Lands Leasing).
Louisiana	Department of Natural Resources, Mineral Resources Office	State undertakes inspection, including geophysical and geological surveys in areas proposed for leasing,	Offered by competitive bid.	Not specified.	Not specified.	Sand for beach nourishment, soliciting sulphur leases. Interest in salt domes, mainly for sulphur-bearing cap rocks. Some commercial interest in placer deposits of eastern delta.		La. Rev. Stat. Ann. §§30:121 to 30: 179.14 (West 1975) (supp. 1966).

Table A-1.—State Mining Laws—Continued

State	Agency	Exploration	Mining permit	Environmental protection	Conflicting uses	Current or past activity	Comments	Statutes and regulations
Maine	Maine Geological Survey	One-year term, renewable for five years. Annual rent rises from \$.25 per acre in the first year to \$5.00 per acre in the fifth. Annual report of exploration results required, kept confidential for term of permit.	Exploration claim may be converted to lease after public hearing. Royalty set case by case, "reasonably related to applicable royalty rates generally prevailing."	Post bond to reclaim area and to protect against damage to property outside lease area.	Not specified	No present mining. A copper mine extending into the sea stopped production about 10 years ago. Coastal waters being surveyed to 100 meter isobath. Detailed mineral studies may begin next year after general survey is complete.	Coastal zone restrictions may make seabed mining difficult.	Me. Rev. Stat. tit. 12, §§549 to 558A (1985).
Maryland.	Maryland Geological Survey, Coastal and Estuarine Branch	Not specified.	Permit required for removal and sale of material	Must follow requirements of State wetlands act.	Not specified.	Shell removal in Chesapeake Bay. Past dredging in Baltimore harbor resulted in sale of sand and gravel. Currently mapping sediment distribution on continental shelf. May look at heavy minerals if initial findings warrant. Some spot checking for sand and gravel in Bay, anticipating need to replace on-land sources supplanted by development.	No statute directly regulates. State uses wetlands and coastal zone statutes to set terms for permit.	
Massachusetts	Department of Environmental Quality Engineering	License and public hearing required. Duration and cost not specified.	Lease required, reviewed at public hearing. A thorough and reliable survey of the resources and environmental risks is required. Survey to be made public at least 30 days before hearing.	Mining prohibited in shellfish areas or in shellfish and finfish spawning, nursery, or feeding grounds. Mining prohibited where hazardous wastes have been dumped.	May not unreasonably interfere with navigation, fishing, or conservation of natural resources.	No mining at present, some beach nourishment projects. Nearly all coastal waters are protected as ocean sanctuaries. Area potentially available for mining is around Boston harbor where a 1972-1973 survey indicated a high concentration of sand and gravel.		Mass. Gen. Laws Ann. ch. 12 §§54 to 56 (West 1981). Mass. Admin. Code tit. 310 ch. 29 (1983).

Table A-1.—State Mining Laws—Continued

State	Agency	Exploration	Mining permit	Environmental protection	Conflicting uses	Current or past activity	Comments	Statutes and regulations
Mississippi	Department of Natural Resources, Bureau of Geology, Mineral Lease Division	Permit required. Data must be provided to State but remains confidential for ten years.	Territorial waters are surveyed and divided into 96 lease blocks up to 6,000 acres in size. Competitive bid/cash bonus. Minimum royalty of 3/16 of minerals extracted. Duration not specified in statute.	Exploration in wildlife management areas or Mississippi Sound or tidelands subject to review by Wildlife Conservation Department. 2 percent of royalties are dedicated to management of waters, land, and wildlife and to clean-up of pollution from exploration or extraction.	Not specified	Oil and gas leases, no hard mineral activity		Miss. Code Ann. §§29-7-1 to 29-7-17 (1965).
New Hampshire.	Department of Resources and Economic Development	Prospecting permit required. One-year term, renewable.	Prospector who discovers a deposit may mine upon filing a claim and obtaining a permit. Lease terms (duration, royalty, special conditions) to be determined upon application for lease.	Permit may be denied if area is unsuitable for mining for environmental reasons or the reclamation plans or pollution prevention measures are insufficient.	Not specified.	No commercial activity. Survey work is being done in State and Federal coastal waters.	Mining statute directed at on-shore activity.	N.H. Rev. Stat. Ann. ch. 12-E (1961).
New Jersey	Tidelands Resource Council	Not specified.	License required to remove sand or other material from state waters. Council determines duration and compensation. Leases are renewable. Riparian owners have priority for leases adjacent to shore.	Not specified.	Not specified.	Sand and gravel being dredged at edge of Ambrose Channel.	Payments go to school trust fund	N.J. Stat. Ann. §§12:3-12, 12:3-21 to 12:3-25.

Table A-1.—State Mining Laws—Continued

State	Agency	Exploration	Mining permit	Environmental protection	Conflicting uses	Current or past activity	Comments	Statutes and regulations
New York	Land Resources Division, Office of General Services	Not specified.	License required, royalty paid to State based on production	Not specified.	Not specified.	Sand and gravel removal in lower New York harbor has been in abeyance since 1984. The State is in the final stages of preparing a 10- year program for renewed sand and gravel dredging.	The environmental impact statement for a blanket water quality certificate is nearly complete. This would allow the State to lease under a long-term management program rather than react to applications case by case.	N.Y. Pub. Lands Law §22 (McKinney 1986).
North Carolina.	Department of Natural Resources and community development	Not specified.	'Within designated boundaries for definite periods of time . . . upon terms and conditions as may be deemed wise and expedient by the State . . . ' Ten-year term, renewable. Hearing required if significant public interest is affected.	A permit may be denied if it will have "unduly adverse effects on wildlife or fresh water, estuarine, or marine fisheries," or if it will violate air or water quality standards.	All leases or sales made subject to rights of navigation.	Moratorium on mining in State waters since 1979. Recent request to explore for sand and gravel denied due to water quality concerns. Task force being formed to study feasibility of phosphate mining.	Proceeds from sales go to Dept. of Natural Resources for administrative costs and for development and conservation of State's natural resources.	N.C. Gen. Stat. §§74-50 to 74-68, 143 B-389, 146-8 (1985).
Oregon	Division of State Lands	Non-exclusive permit, no preferential right to discovered minerals. Two-year term, renewable. Drilling records must be filed with state. Full exploration record may have to be filed as a condition of granting a lease.	Public hearing to determine if inviting bids would be in the public interest. Competitive bid/cash bonus. Minimum royalty 1/8 of gross production. Minimum annual rent of \$.50 per acre, credited toward any royalty due. Ten-year term, renewed for as long as production takes place. Drilling must begin within five years and production must begin within three years of discovery.	Fish and Wildlife Department must be consulted prior to permit or lease. State must consider scenic values, air or water pollution, danger to marine life or wildlife.	State must consider any detriment to people working, living, or owning property in the area, interference with residential or recreational use, or interference with commerce or navigation.	Survey of ocean resources recently completed. Intensive survey of Gorda Ridge (Federal waters) summer of 1986. No mining activity.	Administrative rules for commercial offshore oil, gas & sulphur surveys adopted June 1986. Rules for hard minerals & academic research are being prepared.	Or. Rev. Stat. §273.551 and 274.705 to 274.860 (1981).

Table A-1.—State Mining Laws—Continued

State	Agency	Exploration	Mining permit	Environmental protection	Conflicting uses	Current or past activity	Comments	Statutes and regulations
Rhode Island	Coastal Resources Management Council	Not specified.	Permit from Council required.	The Rhode Island Coastal Resources Management Program classifies State waters and coastal areas, establishing permitted uses and development procedures for each type of area.	See Environmental Protection.	No present activity.	The Council has authority over all development in State waters and over land development which relates to or may conflict with or damage the coastal environment. Mining is prohibited on beaches and dunes and in tidal waters and in salt ponds.	R.I. Gen. Laws tit. 46, ch. 23 (1985).
South Carolina	Land Resources and Conservation Commission	Not specified.	Lease required. Minimum royalty of 1/8 of production.	All leases are subject to conservation laws.	Not specified.	No mining or exploration at present time. There are known phosphate deposits in shallow water, but no commercial interest at present.		S.C. Code Ann. tit. 10, ch. 9 (Law Co-Op. 1976).
Texas	General Land Office, Petroleum and Mineral Development	Exclusive permit up to 640 acres. One-year term, renewable for up to four additional years. Minimum annual rent of \$.25 per acre. Quarterly report required, information remains confidential for as long as prospecting or mining permit is held.	Proposed lease must evidence discovery of a commercial deposit and offer terms comparable to the best lease in the area. Primary term of 20 years and for as long thereafter as minerals are produced in paying quantities. First year rental at least \$2.00 per acre. Subsequent years, \$1.00 per acre against a minimum royalty of 1/16 of value of minerals produced. Monthly royalty report required.	Lease may include any provisions considered "necessary for protection of the interests of the State."	Not specified.	No hard mineral activity. No known resources other than oil and gas in state waters.		Tex. Nat. Res. Code ch. 53 (1986). Tex. Admin. Code tit. 31 §§13.31 to 13.36 (1979).

Table A-1.—State Mining Laws—Continued

State	Agency	Exploration	Mining permit	Environmental protection	Conflicting uses	Current or past activity	Comments	Statutes and regulations
Virginia	Marine Resources Commission	Not specified.	Permit required for removal of material. Lease term five years, renewable. Royalty not less than \$.20 nor more than \$.60 per cubic yard of material removed.	Not specified.	No lease may interfere with public rights to fishing, fowling, or taking of shellfish. Seasonal dredging limitations may be imposed to lessen adverse effects on fisheries.	No current mining. Ongoing research reveals good possibility of commercial titanium-bearing minerals in State and Federal waters.	The State is preparing a subaqueous minerals management plan and is combining field research with a legislative program to meet future development needs.	Va. Code §j62.1-3 and 62.1-4 (1986). Subaqueous Guidelines, Va. Marine Resources Comm. (1986).
Washington	Department of Natural Resources	Lease required, two year term, renewable. Annual rent of \$.25 per acre. Convertible to mining contract. Holder of prospecting lease has preference to mining contract. Lease no less than 40 acres nor more than 640 acres, no limit on number of leases per person.	Twenty-year term, renewable. First four years are prospecting or exploration period.	Work must be "consistent with general conservation principles."	If land to be mined has already been leased for another purpose, lessee is to be compensated for any damage caused by mining or prospecting.	Some prospecting in black sands area at mouth of the Columbia River.		Wash. Rev. Code Ann. §§79.01.616 to 79.01.650 (1985) Wash. Admin. Code ch. 332-16 (1977).

SOURCE: Office of Technology Assessment, 1987,

to education, to administration of the mining program, to resource conservation, to management and research programs, to the agency having management responsibility for the leased property, and to local governments.

Many States require work to proceed at a minimum rate. Some simply require “diligence” or a “good faith effort” or may specify a time limit for starting production (3 years in Delaware and Hawaii, 4 years in Washington). Other States require minimum expenditures for development or improvements (\$2.50 per acre annually in Washington). In Hawaii, the lease may provide for an initial research period during which the lessee is required to undertake research and development to establish economic mining and processing methods for the mineral deposit.

Environmental Protection:

Environmental regulations may require preparation of an environmental impact analysis for each project. Some States prepare a blanket analysis as part of a comprehensive management program, anticipating individual applications. Many statutes identify special areas to be protected or avoided. These include shellfish beds and spawning, nursery, or feeding grounds (Connecticut, Georgia, Massachusetts, and Virginia), areas that are part of the beach sand circulation system, and areas where hazardous wastes have been dumped (Massachusetts). Environmental review also requires coordination with other agencies and statutes. Among these are fish and wildlife departments, air and water quality laws, and coastal zone management agencies.

Conflicting Uses:

Some States identify certain uses as primary or protected, and conflicting uses are prohibited or restricted. Fishing and navigation rights are most commonly mentioned as protected. Virginia may impose seasonal dredging limitations to protect commercially or recreationally important fisheries. Florida gives priority to maintaining natural conditions and propagation of fish and wildlife. Recreation, fishing, and boating are primary uses. Rhode Island State waters are classified by use (from conservation areas to industrial waterfronts) with permitted activities and development spelled out for each class. Connecticut, Delaware, and Oregon require that impacts on upland property owners or users be considered. Hawaii would not allow mining if the existing or reasonably foreseeable use of the property would be of greater benefit to the State. Delaware and Oregon require scenic values to be considered. Pipelines, cables, and aids to navigation are protected by minimum setbacks. Setbacks from shore are specified in some cases, Florida requires oil and gas leases to be

at least 1 mile offshore. Other leases are prohibited from the 3-foot low water depth landward to the nearest paved road. Massachusetts prohibits mining in nearshore areas that supply beach sediments, generally to the 80-foot depth contour.

Public Participation:

About half the States require published notice of a proposed lease, either in a statewide newspaper or in the affected county or both. About one-quarter of the States require a public hearing before granting a lease. Two require a hearing prior to granting a prospecting permit. Massachusetts requires an applicant to disclose “reliable information as to the quantities, quality and location of the resource available . . .”

Regulation and Enforcement:

All States reserve the right to inspect the work site and the prospecting or mining records. Exploration results, development work, and materials mined and sold must be reported. Reporting periods vary from monthly to annual.

The States generally require bonds or insurance to cover faithful performance of the contract, reclamation of the site, and cleanup of pollution resulting from exploration or mining and to indemnify the State against claims arising from the project.

Permits or leases may be revoked for failure to diligently pursue exploration or mining, for failure to meet reporting requirements, or for failure to pay rents or royalties. Revocation is generally an administrative act by the managing State agency and is subject to administrative or judicial appeal. Revocation may be partial, allowing the operator to keep production sites not in default.

Current Activities

There is little offshore mining in State waters at the present time. Sand, gravel, and shell are the only materials currently with significant commercial markets. Existing operations include sand and gravel dredging on the New York and New Jersey sides of Ambrose Channel in lower New York harbor, sand and shell extraction in Florida, shell extraction in Chesapeake Bay, and a pilot gold dredging project off Nome, Alaska. In addition, there are non-commercial beach nourishment programs using offshore sand. The absence of other activity is variously attributed by State officials to a lack of mineral resources, a lack of information about any resources that may exist, or to the higher cost of ocean mining compared to onshore mining of the same material.

The general lack of mining activity means that few of the statutes have been actually tested. But there are several States where recent exploration has spurred a review of existing laws. The Virginia legislature established a Subaqueous Minerals and Materials Study Commission. Now in its third year, the Commission's mandate is 'to determine if the subaqueous minerals and materials of the commonwealth exist in commercial quantities and if the removal, extraction, use, disposition, or sale of these materials can be adequately managed to ensure the public interest. The commission is preparing recommendations for systematic exploration of seabed resources (supplementing the present cooperative effort by the Minerals Management Service, Virginia Division of Mineral Resources, and the Virginia Institute of Marine Science), a subaqueous minerals management plan, and statutory changes (some already adopted) to guide future development.

Public debate over a 1984 permit for seismic studies in the Columbia River prompted Oregon to review its laws. In particular, there was concern with protecting established fishing and navigation interests, maintaining the quality of the marine environment, and providing adequate public input into what had been an in-house agency review process. The Division of State Lands adopted administrative rules for commercial offshore oil, gas, and sulphur surveys in June 1986. It is now preparing administrative rules covering geologic and geophysical surveys by commercial hard mineral prospectors and for academic research. A recent change in Oregon State law permits the Division of State Lands to enter into exploration contracts whereby a prospector would have a preference right to develop and recover minerals should the State move to actually permit ocean mineral development.

Florida adopted marine prospecting rules in January 1987 to cope with a growing number of applications to explore for oil, gas, and other minerals in State waters.

The North Carolina Office of Marine Affairs is beginning a long range project to develop a marine resources management program.

Conclusion

While the States are for the most part inexperienced in managing seabed minerals, they have the ability to develop effective programs. Knowledge and resources from established coastal zone management, water quality, and hydrocarbon development can be readily

tapped. Expertise is also available from academic marine science programs and State geological survey offices. As projects continue, the States have used them as a basis for reviewing their existing management programs and for making improvements.

Since 1983, the Minerals Management Service has been funding State marine minerals research under an annual cooperative agreement with the Texas Bureau of Economic Geology of the University of Texas at Austin. All of the coastal States and Puerto Rico have participated in this program at various times since it began. State research projects focus on both petroleum and hard minerals and range from general surveys of a State's seabed to detailed geologic studies and economic evaluations of specific mineral occurrences. Some of the research extends into Federal waters. The agreement for the fifth year of this program (fiscal year 1987) is now being prepared. Funding has been approximately \$550,000 annually, with about 18 States participating each year.

While a State's role in the Exclusive Economic Zone has yet to be defined, State-Federal task forces have been formed for areas where promising deposits have been found. The task forces' mission is to appraise the commercial potential of the deposits and to oversee the preparation of environmental impact statements for leasing proposals. Such task forces have been formed with Hawaii (cobalt-rich manganese crusts), Oregon and California (polymetallic sulfides in the Gorda Ridge), North Carolina (phosphorites), Georgia (heavy minerals), and the Gulf States (sand, gravel, and heavy minerals off Alabama, Mississippi, Texas, and Louisiana). The functioning of these task forces may provide a needed test of Federal-State cooperation.

If sand and gravel and other nearshore deposits are likely to be the first to be developed, it is also likely that operations will overlap State and Federal jurisdiction. Even activities entirely in Federal waters may concern the States because of environmental effects extending beyond the mining site, economic and social effects of onshore support facilities, or effects on local fishing, navigation, and recreational interests. Proposed mining operations would benefit from a system of compatible Federal and State requirements. Federal support for work by the States can take two paths: continued support for field research to gain better knowledge of marine resources, and support for legislative efforts to develop consistent systems for environmentally sound and economically feasible seabed mining.

Appendix B

The Exclusive Economic Zone and U.S. Insular Territories

U.S. Territorial Law

In addition to the waters off the 50 States, the Exclusive Economic Zone (EEZ) includes the waters contiguous to the insular territories and possessions of the United States.¹ This inclusion is significant in that the islands include only 1.5 percent of the population and 0.13 percent of the land area of the United States*, but 30 percent of the area of the EEZ.³ This appendix discusses the legal relationship between the United States and these islands, with attention to the power of the U.S. to proclaim and manage the EEZ around them.

The general principle of Federal authority has been that, "In the Territories of the United States, Congress has the entire dominion and sovereignty, national and local, Federal and State, and has full legislative power over all subjects upon which the legislature of a State might legislate within the State . . ." "This claim of complete power has been modified for some islands by statutes and compacts granting varying degrees of autonomy to the local population. The discussion below classifies the islands into three categories distinguished by the degree of Federal control and local self-government. The first group (A) includes eight small islands, originally uninhabited, which are under the direct management jurisdiction of Federal agencies. The second group (B) includes American Samoa, Guam, and the Virgin Islands. These islands are largely self-governing but subject to supervision by the Department of the Interior. The third group (C) includes Puerto Rico and the Northern Marianas whose commonwealth status gives them the full measure of internal self-rule where Federal supervisory power is greatly reduced.

Group A

Palmyra Atoll.—Claimed by both Hawaii and the United States early in the 19th century, Palmyra was annexed to the U.S. with Hawaii in 1898. The Hawaii Statehood Bill excluded Palmyra (as well as Midway, Johnston Island, and Kingman Reef) from the territory

¹Proclamation No. 5030, 3 C. F. R. 22 (1984), reprinted in 16 U. S. C. A. 1453 (1985). /

²U. S. Bureau of the Census, *Statistical Abstract of the United States*: 1986, 6 (1985).

³C. Ehler and D. Basta, "Strategic Assessment of Multiple Resource-Use Conflicts in the U.S. Exclusive Economic Zone," *OCEANS '84 Conference Proceeding*, 2 (NOAA Reprint, 1984).

⁴*Simms v. Simms*, 175 U.S. 162, 168 (1899).

of the new State.⁵ The island is privately owned and uninhabited. By executive order it is under the Department of the Interior's jurisdiction.⁶

Johnston Island.—Claimed by the United States and Hawaii in 1858, Johnston Island was annexed to the U.S. in 1898. In the late 1950s and early 1960s the island was the launch site for atmospheric nuclear tests. A caretaker force maintains the site and operations center for the Defense Nuclear Agency (DNA), which is responsible for the island. About 500 U.S. Army personnel are on Johnston, preparing a disposal system for obsolete chemical weapons stored there. Entry is controlled by DNA.⁷

Kingman Reef.—This island was annexed by the United States in 1922. Most of it is awash during high water. The island is under the U.S. Navy's jurisdiction,⁸ but no personnel or facilities are maintained on it.

Midway Islands.—Annexed in 1867, Midway has been managed by the U.S. Navy since 1903.⁹ The Midway Naval Station was closed in 1981, leaving a naval air facility as the only active military installation.

Wake Island.—Wake has been claimed by the United States since 1899. Initially assigned to the U.S. Navy, Wake was transferred to the Department of the Interior (DOI) in 1962¹⁰ and is now administered by the Air Force under special agreement with DOI.¹¹

Howland, Baker, and Jarvis Islands.—Originally claimed under the Guano Act of 1856,¹² these islands were formally annexed by the United States in 1934. They were assigned to DOI 2 years later.¹³ Briefly colonized during the 1930s by settlers from Hawaii, the islands have been uninhabited since World War II.

Comment.—Johnston, Midway, and Wake Islands and Kingman Reef have been declared Naval defense areas and Naval airspace reservations. They are subject to special access restrictions, some of which are suspended but which may be reinstated without notice.

⁵Public Law 86-3 §2, 73 Stat. 4 (1959).

⁶Executive Order No. 10967, 26 Fed. Reg. 9667 (1961).

⁷32 C. F. R. 761.4(c)(1985).

⁸Executive Order No. 6935, Dec. 29, 1934.

⁹Executive Order No. 11048, 27 Fed. Reg. 8851 (1962), superseding Executive Order No. 199-4, Jan. 20, 1903.

¹⁰Executive Order No. 11048, 27 Fed. Reg. 8851 (1962).

¹¹37 Fed. Reg. 12255 (1972).

¹²48 U.S.C. 1411 to 1419 (1982).

¹³Executive Order No. 7368, 1 Fed. Reg. 405 (1936).

¹⁴32 C. F. R. 761 (1985).

The Federal District Court of Hawaii has jurisdiction over civil and criminal matters arising on the eight islands in this group.¹⁵

Group B

American Samoa.—U. S. interest in the islands of American Samoa dates back to the middle of the 19th century, and for a time there were conflicting claims with the United Kingdom and Germany. These claims were settled by a treaty in which Germany and the U.K. renounced all of their rights and claims to the islands east of 171 degrees west longitude in favor of the United States. On April 17, 1900, sovereignty over Tutuila, Aunu'u, and their dependent islands was ceded to the U.S. by their chiefs. The Manu'a islands were similarly ceded on July 14, 1904.¹⁷ The cessions were formally accepted by Congress in 1929.¹⁸ The United States extended sovereignty over Swains Island (originally claimed under the Guano Act) and added it to American Samoa in 1925.¹⁹

The act accepting sovereignty over Samoa states that until Congress provides otherwise, "all civil, judicial, and military powers shall be vested in such person or persons and shall be exercised in such manner as the President of the United States shall direct."²⁰ The U.S. Navy administered American Samoa²¹ until authority was transferred to DOI in 1951.²² The islands are largely self-governing under a constitution adopted in 1966, with DOI exercising only general supervision. The constitution is subject to amendment by Congress.²³ While the cessions, constitution, and statutes of Samoa protect traditional local government and land tenure, all are silent as to any use of the sea beyond the 3-mile territorial limit (tidal and submerged lands have been transferred to the territorial government²⁴). The cessions required respect for local property rights and recognition of the traditional authority of the chiefs over their towns, while "all sovereign rights thereunto belonging" were granted to the United States. Article 1, Section 3 of the American Samoa constitution declares it to be the policy of the government "to protect persons of Samoan ancestry against alienation of their lands and the destruction of the Samoan way of life and language . . ."

¹⁵48 U.S.C. 644a (1982).

¹⁷ Convention for the Adjustment of Questions Relating to Samoa, Dec. 2, 1899, United States—Germany—Great Britain, 31 Stat. 1878

¹⁸The cessions are reproduced in the historical documents section of the American Samoa Code Annotated.

¹⁹1845 Stat. 1253, 48 U.S.C. 1661 (1982).

²⁰43 Stat. 3357, 48 U.S.C. 1662 (1982).

²¹48 U.S.C. 1661(c) (1982)

²² Executive Order No. 125-4, Feb. 19, 1900.

²³ Executive Order No. 10,264, 16 Fed. Reg. 6419.

²⁴48 U.S.C. 1662a (1982).

²⁵48 U.S.C. 1705 (1982)

The American Samoa code implements this policy, preserving "customs not in conflict with the laws of American Samoa and of the United States . . ."²⁵

Guam.—Spain took possession of Guam along with the other Mariana Islands in the 16th century. The treaty ending the Spanish-American war ceded Guam to the United States.²⁶ Article VIII of the treaty ceded crown lands to the U.S. Government and guaranteed protection of existing municipal, church, and private property rights. The U.S. Navy administered the island until 1949 when DOI took over.²⁷ Since then, Guam has been governed under the Organic Act of 1950, as amended.²⁸

The governor and legislature are locally elected and are responsible for most matters of internal governance. DOI's role is to provide "general administrative supervision." The Department is most active in the areas of budget, capital improvements, and technical advice. Congress reserves the power to annul local legislation. A proposed constitution failed to win popular approval in 1979. Since that time, efforts have been redirected toward settling the island's status before another constitutional convention is called. Guam residents strongly favored commonwealth status in a 1982 referendum and a proposed commonwealth act will be presented to the voters in Guam on August 8, 1987.²⁹

Virgin Islands.—The U.S. Virgin Islands were ceded to the United States by Denmark in 1916.³⁰ The rights to crown property were transferred to the U.S. Government, while municipal, church, and private property rights were preserved. Other than a few exceptions named in the treaty, Denmark guaranteed the cession to be "free and unencumbered by any reservations, privileges, franchises, [or] grants . . ."

The U.S. Virgin Islands are self-governing under the Organic Act of 1936³¹ and the Revised Organic Act of 1954, as amended.³² The popularly elected legislature and governor have authority over local matters but Congress retains the power to annul insular legislation.³³ Matters of Federal concern are "under the general administrative supervision of the Secretary of the Interior. DOI's role is mainly administration and auditing of Federal funds appropriated for the islands.

²⁵ Am. Samoa Code Ann. §1.0202 (1983).

²⁶ Treaty of Peace, Dec. 10, 1898, United States—Spain, 30 Stat. 1754

²⁷ Executive Order no. 10077, 14 Fed. Reg. 5523 (1949)

²⁸ Codified at 48 U.S.C. 1421 *et seq.* (1982)

²⁹ Guam Commission Self-Determination, "The Draft Guam Commonwealth Act" (June 11, 1986)

³⁰ Convention for Cession of the Danish West Indies, Aug. 4, 1916, United States—Denmark, 39 Stat. 1706.

³¹ 48 U.S.C. 1391 *et seq.* (1982)

³² 48 U.S.C. 1541 *et seq.* (1982)

³³ 48 U.S.C. 1574(c) (1982)

Like Guam, the U.S. Virgin Islands are authorized to draft their own constitution.³⁴ The most recent of several proposed constitutions was turned down by voters in 1981. At the present time, the issues of a constitution and status are in abeyance.

Comment.—All three of these territories enjoy a large measure of self-rule, but under the territorial clause of the Constitution³⁵ their governments are, in effect, Federal agencies exercising delegated power. Neither the initial cessions nor any subsequent grant of local power have insulated the islands from highly discretionary Federal authority.

The Executive Branch, acting through the Department of the Interior, maintains fiscal and other supervisory powers. Congress retains the right to approve and amend local constitutions or to annul local statutes. It appears that nothing in domestic law would impede the establishment and development of EEZs around these islands.

Group C

Puerto Rico.—Spain ruled Puerto Rico from 1508 until 1898. The island was ceded to the United States by the Treaty of Paris under the same terms and conditions as Guam.³⁶ After nearly 2 years of military rule, the island was administered under Organic Acts passed in 1900³⁷ and 1917.³⁸ In 1950 Congress passed the Puerto Rican Federal Relations Act “in the nature of a compact so that the people of Puerto Rico may organize a government pursuant to a constitution of their own adoption.”³⁹ This Act provided for the automatic repeal of those sections of the 1917 Act pertaining to local concerns and the structure of the island’s government. The repeal was effective upon adoption and proclamation of the constitution in 1952, and Puerto Rico then “ceased to be a territory of the United States subject to the plenary powers of Congress . . .”⁴⁰ The government of Puerto Rico no longer exercises delegated power, and its constitution and laws may not be amended by Congress.

The Puerto Rico constitution establishes the commonwealth and declares that “political power emanates from the people, to be exercised according to their will within the terms of the compact between them and the United States.”⁴¹ “Commonwealth” is an undefined term and, as noted above, the “compact” is not a comprehensive

agreement but the residue of the 1917 Organic Act from which the irrelevant provisions have been stripped. It has remained for the courts to struggle toward clarification of this status.

Puerto Rico is subject to the U.S. Constitution but “like a state, is an autonomous political entity, ‘sovereign over matters not ruled by the Constitution.’”⁴² Federal laws “not locally inapplicable” have the same force and effect in Puerto Rico as in the States.⁴³ Federal statutes may exempt Puerto Rico or may include it on terms different from the States.⁴⁴ Relations between the courts of Puerto Rico and the Federal courts are the same as those for State courts.⁴⁵ The principles of deference and comity apply to Federal court review of Puerto Rico’s legislative, executive, and judicial acts.⁴⁶

For all of its State-like attributes, commonwealth status is inherently ambiguous. Congressional power to treat the island differently leaves Puerto Rico uncertain as to its participation in important Federal programs. Court cases resolving specific issues do not provide a coherent, overall definition of the scope of local authority. What President Johnson called a “creative and flexible” relationship⁴⁷ has come to be viewed as an unsatisfactory, interim arrangement. While disagreeing on the form of the ultimate relationship, all of Puerto Rico’s political parties agree that a clear outline of the island’s powers vis-à-vis the Federal Government is essential.⁴⁸ There are no legal obstacles to such a change. On the island’s side, “the Constitution of the Commonwealth of Puerto Rico does not close the door to any change of status that the people of Puerto Rico desire . . .”⁴⁹ On the Federal side, there have been repeated executive⁵⁰ and congressional⁵¹ declarations that the choice of status remains with the people of Puerto Rico.

Statehood would give Puerto Rico equal standing with the other States in whatever management regime Congress establishes for the EEZ. Independence would

⁴²*Rodriguez v. Popular Democratic Party*, 457 U.S. 1, 8 (1982) (quoting *Mora v. Mejias*, 115 F. Supp. 610, 612 [D. P.R. 1953]).

⁴³48 U.S.C. 734 (1982).

⁴⁴*Harris v. Rosario*, 446 U.S. 651 (1980) (per curiam) (overturning a ruling that lower A.F.D.C. payments in Puerto Rico violate the equal protection guarantees of the Fifth Amendment under the territorial clause. ‘Congress may treat Puerto Rico differently from States so long as there is a rational basis for its actions.’

⁴⁵48 U.S.C. 864 (1982).

⁴⁶*Rodriguez v. Popular Democratic Party*, supra, at 8; *Hernandez-Agosto v. Romero-Barcelo*, 748 F.2d 1, 5 (1st Cir. 1984).

⁴⁷Statement, Response to the Report of the United States—Puerto Rico Status Commission, 2 Weekly Comp. Pres. Dec. 1034 (Aug. 5, 1966).

⁴⁸P. Falk, ed., *The Political Status of Puerto Rico* (Lexington, MA: Lexington Books, 1986); *Puerto Rico’s Political Future: A Divisive Issue with Many Dimensions* (GAO Report GGD-81-48, Mar. 2, 1981).

⁴⁹*Puerto Rico Socialist Party v. Commonwealth*, 107 P. R. Dec. 590, 606 (1978).

⁵⁰2 Weekly Comp. Pres. Dec. 1034 (Aug. 5, 1966) (Johnson); 12 Weekly Comp. Pres. Dec. 1225 (July 7, 1976) (Ford); 13 Weekly Comp. Pres. Dec. 1374 (Sept. 17, 1977) (Carter); 18 Weekly Comp. Pres. Dec. 19 (Jan. 12, 1982) (Reagan).

⁵¹S. Con. Res. 35, 93 Stat. 1420 (1979).

³⁴Public Law 94-584, 90 Stat. 2899 (1976), as amended by Public Law 96-597, 94 Stat. 3479 (1980).

³⁵U.S. Const. art. IV, §3.

³⁶See note 26, above.

³⁷The Foraker Act, ch. 191, 31 Stat. 77 (1900).

³⁸The Jones Act, ch. 145, 39 Stat. 951 (1917).

³⁹Ch. 446, 64 Stat. 319 (1950).

⁴⁰*United States v. Quinones*, 758 F.2d 40, 42 (1985).

⁴¹P.R. Const. art. I, §1.

give the island full control and sovereignty. Under the present system, the island's local power does not include rights in the EEZ. The Popular Democratic Party's proposed modifications to the compact include local authority over the use of natural resources and the sea.⁵²

The Northern Mariana Islands.—These islands were colonized by Spain in the 16th century and transferred to Germany in 1899. Japan seized Germany's Pacific possessions in 1914 and was given a mandate over them by the League of Nations in 1920. The Marianas were taken by the United States during World War II. In 1947, the United States was granted a trusteeship over the former Japanese mandated islands.⁵³ As permitted by the charter of the United Nations, the Trusteeship Agreement recognized both the strategic interests of the United States and the political, economic, and social advancement of the inhabitants.⁵⁴ Status negotiations with the Northern Marianas resulted in the establishment of a commonwealth "in political union with the United States."⁵⁵ The other three island groups of the Trust Territory became free associated states.⁵⁶ When the U.S. EEZ was proclaimed, the Marianas were included in the zone "to the extent consistent with the Covenant and the United Nations Trusteeship Agreement."⁵⁷ Article 6(2) of the Trusteeship Agreement requires the United States to "promote the economic advancement and self-sufficiency of the inhabitants" by regulating the use of natural resources, encouraging the development of fisheries, agriculture, and industries, and protecting the inhabitants against the loss of their lands and resources. The Covenant is silent as to management of ocean resources but provides for a constitution to be adopted by the people of the Northern Mariana Islands and submitted to the United States for approval on the basis of consistency with the Covenant, the U.S. Constitution, and applicable laws and treaties.⁵⁸ The constitution was adopted *locally on*

March 6, 1977, and proclaimed effective on January 9, 1978 by President Carter.⁵⁹ Unlike the Covenant, the constitution contains two provisions relevant to the EEZ. Article XI (Public Lands) declares submerged lands off the coast to which the Commonwealth may claim title under U.S. law to be public lands to be managed and disposed of as provided by law. Article XIV (Natural Resources) provides, in Section 1, that "[t]he marine resources in waters off the coast of the Commonwealth over which the Commonwealth now or hereafter may have jurisdiction under United States law shall be managed, controlled, protected and preserved by the legislature for the benefit of the people.

U.S. interest in the Northern Marianas under the Trusteeship Agreement was administrative, not sovereign. The change to U.S. sovereignty required United Nations approval to be implemented. On May 28, 1986, the United Nations Trusteeship Council concluded that U.S. obligations had been satisfactorily discharged, that the people of the Northern Marianas had freely exercised their right to self-determination, and that it was appropriate for the Trusteeship Agreement to be terminated.⁶⁰ On November 3, 1986, President Reagan issued a proclamation ending the trusteeship, fully establishing the Commonwealth, and granting American citizenship to its residents.⁶¹ As a U.S. territory, the Northern Marianas are now subject to U.S. law in the manner and to the extent provided by the Covenant.

The Exclusive Economic Zone and U.S. Territorial Law

Under our system, the authority of Congress over the territories is both clear and absolute. This authority originates in the constitutional grant to Congress of the "Power to dispose of and make all needful Rules and Regulations respecting the Territory or other Property belonging to the United States." Any restriction on this power would come from the terms under which a territory was initially acquired by the United States or from a subsequent grant of authority from Congress to the territory. As shown above, the present territories have no explicitly reserved or granted power to manage the EEZ. It has also been shown that Congress may treat the territories differently from the States as long as there is a rational basis for its action.

The territorial clause has two purposes: to bring civil authority to undeveloped frontier areas and to promote their political and economic development. Its goal is the achievement, through statehood or some other arrangement, of a clear and stable relationship between the ter-

⁵²*Puerto Rico's Political Future*, supra n 48, 45

⁵³Trusteeship Agreement for the Former Japanese Mandated Islands, July 18, 1947, 61 Stat. 3301, T. I. A. S. No 1665 [hereinafter "Trusteeship Agreement"]

⁵⁴U. N. Charter, chapter XII, Trusteeship Agreement, arts. 1, 5, 6.

⁵⁵Covenant to Establish a Commonwealth of the Northern Mariana Islands in Political Union with the United States, Feb. 15, 1975, 90 Stat. 263 [hereinafter "Covenant"]

⁵⁶As such, they are independent countries in which U. S. interest is mostly limited to security matters. The Compacts provide that the states conduct foreign affairs in their own names, including "the conduct of foreign affairs relating to law of the sea and marine resource matters, including the harvesting, conservation, exploration or exploitation of living and non-living resources from the sea, seabed, or sub-soil to the full extent recognized under international law." Compact of Free Association Federated States of Micronesia and Republic of the Marshall Islands and Palau, Jan. 14, 1986, 99 Stat. 1770, art. II, §121 [hereinafter "Compact"] This provision puts the three states outside the scope of the U. S. Exclusive Economic Zone Proclamation No 5564, note 60, below, effectuated the Compact with the Federated States of Micronesia and with the Republic of the Marshall Islands. The Compact with The Republic of Palau is undergoing the local ratification process

⁵⁷Proclamation No. 5030, supra note 1.

⁵⁸Covenant, art. 1 I.

⁵⁹Proclamation No 4534, 42 Fed. Reg. 56593 (1977).
w. r. c. Res. 2183 (LIII) (1986)

⁶¹proclamation No 5564, 51 Fed. Reg 40399 (1986)

ritory and the rest of the Union. In the past, Federal control over territorial affairs was tolerable because eventual statehood would bring equality of treatment and constitutional limitations on Federal power. There are grounds for suggesting that the present territories do not fit the pattern of earlier ones and that they are "poorly served by a constitutional approach based on evolutionary progress toward statehood."⁶² Rather than being frontier areas settled by Americans who later petitioned their government for statehood, the present territories joined the U.S. with developed cultures of their own and may wish to preserve their uniqueness by remaining apart from the Union of States. Proposals to develop the EEZ, like other Congressional action under the territorial clause, should recognize their special position.

International Law Considerations

The EEZ is based on international law's recognition of a coastal state's right to manage resources beyond the Territorial Sea. President Reagan based the proclamation on this international principle and stated that the "United States will exercise these sovereign rights and jurisdiction in accordance with the rules of international law."⁶³ This section examines how international law may bear on the EEZ around U.S. territories.

The primary sources of international law are treaties and international custom.⁶⁴ The former is explicit and documented while the latter is deduced from actual practice. This review will focus on three areas relevant to territories: the United Nations Charter and resolutions pertaining to non-self-governing territories, the United Nations Convention on the Law of the Sea, and the practice of other countries with respect to their overseas territories.

The United Nations Charter and Resolutions

Article 73 of the United Nations Charter calls on member states to recognize that the interests of the inhabitants of non-self-governing territories are paramount. Members are to ensure the political, economic, social, and educational advancement of the territories and to promote constructive measures for their development. In addition, members accept a responsibility "to develop self-government, to take due account of the political aspirations of the peoples, and to assist them in the progressive development of their free political institutions, according to the particular circumstances of

each territory and its peoples and their varying stages of advancement."⁶⁵

Two General Assembly resolutions amplify the United Nations' view of territories. Resolution 1514 calls for immediate steps to transfer all powers to the people of trust and non-self-governing territories "in accordance with their freely expressed will and desire."⁶⁶ Resolution 1541, passed a day later, establishes principles for determining when a territory reaches "a full measure of self government."⁶⁷ Three options are recognized: independence, free association with an independent state, and integration with an independent state. The United Nations has formally recognized the free association status of Puerto Rico⁶⁸ and of the Northern Marianas.⁶⁹ The United States provides annual reports to the United Nations concerning American Samoa, Guam, and the U.S. Virgin Islands, and they have been the subject of occasional visiting missions from the United Nations. Their status, along with other non-self-governing territories has been reviewed annually by the General Assembly. The most recent resolutions are typical in calling on the United States and the territories to safeguard the right of the territorial people to the enjoyment of their natural resources and to develop those resources under local control.⁷⁰ Significantly, the resolution concerning Guam urges the United States "to safeguard and guarantee the right of the people of Guam to the natural resources of the Territory, including marine resources within its exclusive economic zone . . ."

These documents do not, of their own force, require action on the part of the United States. The Charter and the resolutions provide the international norms under which the United States and the territories may mutually decide the terms of their relationship. There is an obligation on the part of the United States to promote the development of the territories while protecting their free choice of political status. This obligation is not inconsistent with the view of the territorial clause as promoting the political and economic development of the territories.

The United Nations Convention on the Law of the Sea

The United States has not signed the United Nations Convention on the Law of the Sea because of objections to its deep seabed mining provisions. Nevertheless, the

⁶²Leibowitz, *United States Federalism: The States and the Territories*, 28 Am. U.L.Rev. 449, 451 (1979).

⁶³Proclamation No. 5030, *supra* n. 1.

⁶⁴Restatement (revised) of Foreign Relations Law of the United States¹⁰² (Tent. Draft No. 6, 1985).

⁶⁵U.N. Charter, art. 73(b).

⁶⁶G. A. Res. 1514, 15 U.N. GAOR Supp. 16, at 66 (1960).

⁶⁷G. A. Res. 1541, 15 U.N. GAOR Supp. 16, at 29 (1960).

⁶⁸G. A. Res. 748 (VIII) (1953).

⁶⁹T. C. Res. 2183 (LIII) (1986).

⁷⁰G. A. Res. 41/23 (Question of American Samoa), G. A. Res. 41/24 (Question of the United States Virgin Islands), G. A. Res. 41/25 (Question of Guam), 41 GAOR Supp. 53 (1986).

United States “will continue to exercise its rights and fulfill its duties in a manner consistent with international law, including those aspects of the Convention which either codify customary international law or refine and elaborate concepts which represent an accommodation of the interests of all States and form a part of international law. The presidential statement accompanying the EEZ proclamation contains similar language. 72 The body of the Convention contains only one reference to territories. Article 305(1) provides that self-governing associated states and internally self-governing territories ‘which have competence over the matters governed by this Convention including the competence to enter treaties in respect of those matters’ may sign the convention. Accompanying Resolution III declares that in the case of territories that have not achieved a self-governing status recognized by the United Nations, the Convention’s provisions “shall be implemented for the benefit of the people of the territory with a view to promoting their well-being and development. The former provision recognizes that territories may achieve a degree of autonomy allowing them to participate in international matters. The Cook Islands and Niue, states associated with New Zealand, have signed the Law of the Sea Treaty under Article 305(1).⁷³ Resolution III restates the commitments of Article 73 of the Charter and of Resolutions 1514 and 1541. Article 305(1) and Resolution III both reiterate international norms compatible with U.S. territorial management.

Practices of Other Countries

Where there is no treaty or other explicit source, international law may be ascertained from “the customs and usages of civilized nations.”⁷⁴ A 1978 study reviewed the law and practice of six nations with respect to their overseas territories.⁷⁵ The study found as a general rule that metropolitan powers with overseas territories or associated states: 1) have either given the population of the overseas territory full and equal representation in the national parliament and government or 2) have given the local government of the overseas territory jurisdiction over the resources of the EEZ. The first category includes Denmark (Faroe Islands and Greenland), France (overseas departments and territories), and Spain (Canary Islands). The second category

⁷¹Declarations Made upon Signature of the Final Act at Montego Bay, Jamaica, on Dec. 10, 1982—United States of America. (Quoted in Theutenberg, *The Evolution of the Law of the Sea*, 223 [Dublin: Tycooly International Publishing, 1984]).

⁷²Statement on United States Oceans Policy, 19 Weekly Comp. Pres. Doc. 383 (1983).

⁷³Status Report, UN convention on the Law of the Sea, ST/LEG/SER E 14 at 701 (1985).

⁷⁴*The Paquete Habana*, 175 U.S. 677, 700 (1900).

⁷⁵TFranck, *Control of Sea Resources by Semi-Autonomous States* (Washington, DC: Carnegie Endowment for International Peace, 1978)

includes the United Kingdom (Caribbean Associated States), New Zealand (Cook Islands and Niue), and the Netherlands (Netherlands Antilles). While small, this study includes all instances of overseas territories having no, or token, representation in the metropolitan government. The study concludes that the United States represents the sole significant exception to the rule. American territories have neither full representation nor local control of the EEZ.

While some information in the 1978 study is no longer current (for example, the Caribbean Associated States are now fully independent nations), its conclusion still seems correct. British practice, as exemplified by the recent declaration of an exclusive fisheries zone around the Falkland Islands, is for the national government to establish policy and for the territorial government to implement it. Thus, the Falkland’s government will decide on the optimum level of fishing, issue licenses, and establish and collect fees and taxes. London will provide advice and technical assistance.⁷⁶

The practice of the Netherlands is similar. Matters of broad policy are decided in the Hague, with consideration given to the preference of the Antilles. Exploration and management are in the hands of the Antilles, and the benefits from production would go to the islands.⁷⁷

The Territories Under International Law

Though relatively recent, the EEZ is a generally accepted concept of international law. The United States based its proclamation on international law and declared its intent to follow that law in managing the zone. The declarations of the United Nations, the Law of the Sea Convention, and the practice of other nations are not, of themselves, mandatory upon the United States. Taken as a whole, however, they outline international norms for the treatment of territories. These norms suggest that if territories are not fully integrated (and represented) in the national government, their natural resources should be managed for the benefit of the local population.

Territorial Laws Affecting the EEZ

Geography, history, and culture bind the territories to the sea. All of them have adopted laws pertaining to activities in the ocean. These range from coastal zone management and water quality laws akin to those adopted by the States to broad claims of jurisdiction amounting to local EEZs.

⁷⁶Conversation with Robert Embleton, Second Secretary, British Embassy, Washington, D.C., Dec. 10, 1986

⁷⁷Conversation with Harold Henriquez, Netherlands Antilles Attache, Embassy of the Netherlands, Washington, D.C., Dec. 10, 1986

American Samoa's water quality standards provide for protection of bays and open coastal waters to the 100 fathom depth contour. A permit is required for any activity affecting water quality in these areas.⁷⁸

The U.S. Virgin Islands coastal zone management program extends "to the outer limit of the Territorial Sea" (3 nautical miles). Its environmental policies call for accommodating "offshore sand and gravel mining needs in areas and in ways that will not adversely affect marine resources and navigation."⁷⁹ A permit to remove material is required and may not be granted unless such material is not otherwise available at reasonable cost. Removal may not significantly alter the physical characteristics of the area on an immediate or long-term basis. The Virgin Islands government collects a permit fee and a royalty on material sold.

The U.S. Virgin Islands and American Samoa do not assert their jurisdiction beyond the 3 nautical miles of Territorial Sea granted to them.⁸⁰ The other three self-governing territories have taken steps to assure themselves greater control of their marine resources.

By a law adopted in 1980, Guam defines its territory as running 200 geographical miles seaward from the low water mark. Within this territory, Guam claims "exclusive rights to determine the conditions and terms of all scientific research, management, exploration and exploitation of all ocean resources and all sources of energy and prevention of pollution within the economic zone, including pollution from outside the zone which poses a threat within the zone."⁸¹ In a letter accompanying the bill, the governor stated that, "[a]s a matter of policy, the territory of Guam is claiming exclusive rights to control the utilization of all ocean resources in a 200-mile zone surrounding the island."⁸² Possible conflicts with Federal law were recognized, but the law was approved "as a declaration of Territorial policies and goals. Section 1001(b) of the proposed Guam Commonwealth Act includes a similar claim to an EEZ."⁸³

Puerto Rico claims "[o]wnership of the commercial minerals found in the soil and subsoil of Puerto Rico, its adjacent islands and in surrounding waters and submerged lands next to their coasts up to where the depth of the waters allows their exploitation and utilization, in an extension of not less than 3 marine leagues . . ."⁸⁴ This continental shelf claim extends beyond Puerto Rico's Territorial Sea. It combines the principles of adjacency and exploitability codified in the 1958 Convention on the Continental Shelf.⁸⁵ A statement of motives

accompanying the 1979 amendments to Puerto Rico's mining law explains the Roman and Spanish law antecedents for government trusteeship of minerals. It also points out that Section 8 of the Organic Act of 1917 placed submerged lands under the control of the government of Puerto Rico and gave the island's legislature the authority to make needed laws in this field "as it deems convenient. The legislature concluded that "after 1917, the Federal Government has no title or jurisdiction over the submerged lands of Puerto Rico. The title is vested fully in Puerto Rico. It is up to the Legislature to determine the extent of said jurisdiction."⁸⁶

The most comprehensive territorial management program is that of the Northern Mariana Islands. The Commonwealth's Marine Sovereignty Act of 1980 establishes archipelagic baselines, claims a 12-mile Territorial Sea, and declares a 200-mile EEZ.⁸⁷ The Submerged Lands Act applies from the line of ordinary high tide to the outer limit line of the EEZ. It requires licenses and leases for the exploration, development, and extraction of petroleum and all other minerals in submerged lands.⁸⁸ The latter statute has been implemented by detailed rules and regulations.

These claims are based on the statutory law of the Trust Territory of the Pacific Islands which confirmed the earlier Japanese law "that all marine areas below the ordinary high watermark belong to the government."⁸⁹ A subsequent order of the Department of the Interior transferred public lands, among them submerged lands, to the constituent districts of the Trust Territory, including the Northern Mariana Islands.⁹⁰ In addition, Section 801 of the Covenant provides for transfer of the Trust Territory's real property interests to the Northern Marianas no later than the termination of the trusteeship.

There is some question as to whether the conditional inclusion of the Northern Marianas in the U.S. EEZ Proclamation ("to the extent consistent with the Covenant and the United Nations Trusteeship Agreement" implies recognition of local claims. There is also a question as to whether U.S. territorial law would permit this local claim to survive the transition to U.S. sovereignty. The Supreme Court has held that ownership of submerged lands is vested in the Federal Government as "a function of national external sovereignty, essential to national defense and foreign affairs."⁹¹ When the trusteeship over the Northern Marianas ended, the United States extended its sovereignty over the islands

⁷⁸Am.Samoa Admin. Code §§24.0201 to 24.0208 (1984).

⁷⁹V.I. Code Ann. tit. 12, §906(b)(7) (1982).

⁸⁰See note 24, above.

⁸¹Guam Code Ann. §402 (1980).

⁸²*Id.*, Compiler's Comment.

⁸³See note 29, above.

⁸⁴P. R. Laws Ann. tit. 28, §111 (1985).

⁸⁵15 U. S. T. 471, T. I.A. S. No. 5578, 499 U. N.T. S. 311.

⁸⁶1979 P.R. Laws 279, 281.

⁸⁷Commonwealth of the Marianas Code, tit. 2, §1101-1143 (1984).

⁸⁸Commonwealth of the Marianas Code, tit. 2, §1211-1231 (1984).

⁸⁹Trust Territory Code, tit. 67, §2(1970).

⁹⁰Department of the Interior Order 2969 (Dec. 28, 1974).

⁹¹*United States v. California*, 332 U.S. 19, 34 (1947).

and became responsible for their foreign affairs and defense. The situation of the Northern Mariana Islands may be comparable to that of Texas, which was admitted to the Union after having been an independent country. When it joined the United States, Texas relinquished its sovereignty and, with it, her proprietary claims to submerged lands in the Gulf of Mexico.⁹²

In 1985, the Northern Mariana Islands Commission on Federal Laws suggested that Congress convey to the Marianas submerged lands to an extent of 3 nautical miles “without prejudice to any claims the Northern Mariana Islands may have to submerged lands seaward of those conveyed by the legislation.”⁹³ The Commission recognized that there are strong arguments for and against the Northern Marianas’ continued ownership of submerged lands after termination of the trusteeship, but it pointed out that it “makes little sense” for the United States to transfer title to the islands, only to have that title revert to the United States under the doctrine

⁹²*United States v. Texas*, 339 U.S. 707 (1950).

⁹³Second Interim Report to the Congress of the United States, 172. The Commission is appointed by the President under Section 504 of the Covenant to make recommendations to Congress as to which laws of the United States should apply to the Commonwealth and which should not,

of *United States v. Texas*.⁹⁴ The Commonwealth is still negotiating with the Executive Branch over the acceptance or modification of its marine claims.

Territorial Ocean Laws

The history and culture of the territories are intertwined with the ocean. Some of them have acted to assert their own claims to manage ocean resources beyond the territorial sea, although their authority to do so is uncertain under U.S. territorial law. The present situation is one of latent conflict which could become active when marine prospecting or development is proposed. Should the United States decide that Federal jurisdiction is exclusive, an explorer or miner may be greatly delayed while Federal and territorial authorities argue their positions in court. A Congressional resolution of this conflict would require action using the plenary powers of the Constitution’s territorial clause, tempered by the goals of American and international territorial law, and the political and economic development of the territories and their people.

⁹⁴*Id.*, 178, 179.

Mineral Laws of the United States

The five legal systems discussed below illustrate the changes in national minerals policy over the past century. One major shift was from a policy of free disposal, intended to foster development of the frontier, to a leasing policy intended to provide a return to the public and to foster conservation by controlling the rate of development. A second change resulted in a balancing of mineral values against other values for the land in question. Thus, the Mining Law of 1872 requires only that the land be valuable for minerals, but the leasing laws allow a lease only after a prospector shows that the land is “chiefly valuable” for the mineral to be developed. The leasing laws, and, to a greater extent, the Outer Continental Shelf Lands Act also require consideration of economic and environmental impacts, State and local concerns, and the relative value of mining and other existing or potential uses of the area. A third change was a recognition that different types of minerals could best be developed under different management systems. The hardrock minerals remain under a system that rewards the prospector’s risk-taking, the fuel resources are leased under a system that takes national needs and priorities into account, and common construction materials are made readily available under a simplified sales procedure. When creating a legal regime for the mineral resources of the Exclusive Economic Zone (EEZ), the United States can benefit from long experience under several diverse systems.

The experimental nature of much of today’s exploration and recovery equipment and the gaps in our knowledge of the physical and biological resources of the EEZ indicate that it may take years of research and exploration before an informed decision to proceed with commercial exploitation can be made. A legal system must reasonably accommodate the risk being taken by the mineral industry under these circumstances. At the same time, the system must also accommodate important public interests and ensure a fair market value for the public resources. The law must also consider the national and State interests in ocean development and define the respective Federal and State roles.

Onshore Mineral Management

Federal onshore minerals are managed under three principal legal systems: the Mining Law of 1872, the Mineral Leasing Act of 1920 and related leasing laws, and the Surface Resources Act of 1955 (table C-1). The laws do not apply uniformly to all Federal lands, and a mineral may be subject to different rules in different

places, including some cases where there appears to be no applicable law at all.

The Mining Law of 1872

The Mining Law of 1872 is applicable to “hardrock” minerals in the public domain in most States. Like other laws of its era, it was intended to expand development of the Western States by making Federal lands available to persons who occupy and develop them. It adopted a system that was developed under State law and local custom between the start of the California gold rush in 1849 and passage of the first mining law in 1866.

All valuable mineral deposits and the lands in which they are found are free and open to exploration, occupation, and purchase. State mining laws and customs of the mining districts are recognized to the extent that they do not conflict with Federal law. The Mining Law outlines the requirements for locating, marking, and evaluating claims; sets a \$100 minimum for annual expenditures on labor or improvements; and provides for transfer of ownership to the miner when these conditions are met. Depending on the type of deposit, payment of \$2.50 or \$5.00 per acre is required. The Government receives no royalties or other payments for the minerals.

In its original form, the Mining Law allowed for the greatest individual initiative and the least Government regulation. Over the years, its operation has become more restricted. First, the Government has withdrawn extensive areas from the operation of the Mining Law when they were needed for other purposes (military reservations, national parks, dam and reservoir sites, etc.). Second, certain minerals were excluded from the law and made available under other programs. Third, mining operations are subject to environmental and reclamation requirements and varying degrees of review and approval by the surface management agency. Prior to issuance of a patent, a claimant’s use of a mining claim is limited to that required for mineral exploration, development, and production. Nonconflicting surface uses by others may continue.

Mineral Leasing Acts

Concern over resource depletion and monopolization in the early years of the 20th century lead to withdrawals of coal, oil, phosphate, and other fuel and nonmetallic minerals from entry under the Mining Law. In 1920 Congress passed the Mineral Leasing Act, making these

Table C-1.-Comparison of Federal Mineral Statutes

	Entry and patent system	Mineral leasing systems	Materials sale system	Continental shelf leasing system	Deep seabed system
Law and Applicability	General Mining Law of 1872 (30 U.S.C. 22 <i>et seq.</i>): hard rock minerals in the public domain in all States except Alabama, Kansas, Michigan, Minnesota, Missouri, Oklahoma (except ceded Indian lands), and Wisconsin. Withdrawals and reservations make specified areas unavailable or conditionally available.	Mineral Leasing Act of 1920 (30 U.S.C. 181 <i>et seq.</i>): coal, oil, oil shale, gas, gilsonite, phosphate, potash, and sodium in the public domain and disposed lands in which mineral rights were retained. Mineral Leasing Act for Acquired Land (30 U.S.C. 351 <i>et seq.</i>): above minerals and sulphur in acquired lands. Reorganization Plan No. 3 of 1946 (60 Stat. 1097): all other minerals in acquired national forests and grasslands.	Materials Act of 1947 (30 U.S.C. 601-604): "common varieties" of sand, stone, gravel, cinders, and clay on public lands. Surface Resources Act of 1955(30U.S.C.611-615): excludes above minerals from the scope of the General Mining Law.	Outer Continental Shelf Lands Act (43 U.S.C. 1331-1356): all minerals in the submerged lands of the outer continental shelf beyond the territorial waters of the 50 States.	Deep Seabed Hard Minerals Resources Act (30 U.S.C. 1401-1473): manganese nodules on the deep seabed outside the continental shelf or resource jurisdiction of any nation.
Initiative	Miner	Miner or the Department of the Interior	Miner	Miner or the Department of the Interior, pursuant to a 5-year leasing program.	Miner
Prospecting	"Free and Open"	By permit or license from the Department of the Interior. Prospecting permits not issued for oil or gas.	Not applicable	Lessee's exploration plan, subject to approval by the Department of the Interior.	By license from the National Oceanic and Atmospheric Administration.
Establishing Tenure	Discovery of a valuable deposit within limits of claim. Marking and recording claim as required by Federal and State law.	Entering into a lease. Non-competitive lease to first qualified applicant where mineral potential is unknown. Preference-right lease to prospector who discovers a valuable deposit. Competitive bid for leases in known mineral areas.	Disposal by sale. Use of a site may be communal or nonexclusive. Miner does not acquire a property right.	Entering into a lease granted after competitive bidding.	Obtaining a permit upon demonstrating financial and technological capability.
Maintaining Tenure	\$100 worth of labor or improvements annually on each claim until a patent is issued.	Compliance with terms of lease, including payments, diligent exploration and development, safety, resource conservation, and environmental protection.	Not applicable	Compliance with terms of lease, including payment, rate of production, safety, protection of fish, wildlife, and environment.	Diligent development, minimum expenditures, maintaining recovery for the duration of the permit.
Area Limits	<i>Lode claims: 1500 feet x 600 feet. Placer claims: 20 acres or up to 160 acres for an association claim. No limit on the number of claims that a person may locate.</i>	Coal: size of individual lease determined by Secretary of the Interior, 46,080 acres in any one State, 100,000 acres nationwide. Sodium: 2,560 acres in any one lease, 5,120 acres in any one State, may be raised to 15,360 acres if necessary for economic mining. <i>Phosphate: 20,480 acres nationwide. Oil or gas: 640 acres per lease unit, 246,080 acres in any one State except Alaska where the limit is 300,000 acres in each of two leasing districts. Oil shale or gilsonite: 5,120 acres. Sulphur: in Louisiana and New Mexico, 640 acres per lease. Potash: 2,560 acres per lease.</i>	Not applicable	Oil or gas: 5,760 acres unless a larger area is necessary to comprise a reasonable economic production unit. <i>Sulphur and other minerals: size determined by the Secretary of the Interior.</i>	Size and location chosen by miner. Must comprise a logical mining unit.

Table C-1.—Comparison of Federal Mineral Statutes—Continued

	Entry and patent system	Mineral leasing systems	Materials sale system	Continental shelf leasing system	Deep seabed system
Term	An unpatented mining claim may be held indefinitely.	<i>Coal:</i> 20 years and as long thereafter as coal is produced annually in commercial quantities. <i>Phosphate and Potash:</i> 20 years and for as long thereafter as lessee complies with terms and conditions of lease. <i>Oil and gas:</i> 5 years for competitive and 10 years for non-competitive leases and for as long thereafter as there is production in paying quantities. <i>Oil shale:</i> indeterminate period. <i>Sodium:</i> 20 years with a preference right to renew for additional 10 year periods.	Not applicable	<i>Oil and gas:</i> 5 years (10 years if Secretary finds that a longer period is necessary to encourage development) and for as long thereafter as oil or gas is produced in paying quantities. <i>Sulphur:</i> 10 years and as long thereafter as sulphur is produced in paying quantities. <i>Other minerals:</i> prescribed by Secretary.	20 years and for as long thereafter as minerals are recovered annually in commercial quantities.
Assignability	An unpatented mining claim may be leased, sold, mortgaged, or inherited.	All or part of a lease may be assigned with Department of Interior permission.	Not applicable	A lease may be assigned with Department of Interior permission.	A permit or license may be transferred with NOAA approval.
Payment	\$2.50 or \$5.00 per acre patent fee.	Minimum rents and royalties established by statute, actual rates set by competitive bid. <i>Coal:</i> rent set by regulation (currently \$3.00 per acre), minimum royalty of 12.5 percent for surface mines, may be less for underground mines, cash bonus. <i>Phosphate:</i> minimum rent \$.25 per acre in the first year, \$.50 in the second year, and \$1.00 per acre in the third and subsequent years, credited against a minimum royalty of 5 percent of gross value of output. <i>Oil and gas:</i> minimum annual rent \$.50 per acre, rising to \$1.00 per acre after oil or gas in paying quantities are discovered, minimum royalty of 12.5 percent, cash bonus. <i>Oil shale:</i> minimum annual rent of \$.50 per acre, credited against a royalty set by the Secretary. Rent and royalty may be waived for the first 5 years to encourage production. <i>Sodium and potash:</i> minimum rent \$.25 per acre in the first year, \$.50 in the second year and \$1.00 in the third and subsequent years credited against a minimum royalty of 2 percent of gross value of production.	Fair market value of material taken. No charge to governmental and nonprofit entities.	<i>Oil and gas:</i> competitive bidding in which the royalty rate, cash bonus, work commitment, or profit share or any combination of them maybe the biddable factor. Minimum royalty of 12.5 percent. <i>Sulphur:</i> competitive bid on cash bonus, minimum royalty of 5 percent of gross value of production, rent prescribed by Secretary. <i>Other minerals:</i> competitive bid on cash bonus; royalty and rent prescribed by Secretary.	Administrative fee to cover the cost of reviewing and processing applications. Tax of 3.75 percent on imputed value of resources removed pursuant to permit.

Table C-1.-Comparison of Federal Mineral Statutes—Continued

	Entry and patent system	Mineral leasing systems	Materials sale system	Continental shelf leasing system	deep seabed system
Allocation of Income	Not specified	<i>On public domain:</i> 50 percent to State, 40 percent to reclamation fund, 10 percent to U.S. Treasury. <i>In Alaska:</i> 90 percent to State. <i>On acquired land:</i> in the same manner as other income from the affected lands (varies by management agency).	In the same manner as other income from the affected lands (varies by management agency).	Credited to miscellaneous receipts of the U.S. Treasury.	Fee credited to miscellaneous receipts of the U.S. Treasury. Tax credited to Deep Seabed Revenue Sharing Trust Fund.
Conflicting Uses	Exclusive possession of the surface limited to use for mining purposes. Non-conflicting surface uses by others may continue.	Coal leases must be compatible with a comprehensive land use plan considering the effects on the surrounding area or community. All leases on acquired land require the consent of the surface management agency and are subject to conditions assuring that the primary purpose for which the lands were acquired is maintained. No leasing in national parks or monuments or in incorporated municipalities.	Consent of surface management agency required. Excludes land in national parks and monuments and Indian lands.	Leasing program must consider economic, social, and environmental values and potential impacts on fisheries, navigation, and other resources of the outer continental shelf.	Permits and licenses are exclusive as against any U.S. or reciprocating State citizen. Activities may not unreasonably interfere with freedom of the seas, conflict with any international obligation of the U. S., lead to a breach of the peace, or pose a safety hazard.
Environmental Protection	Not specified	Coal leases may not be granted without consideration of environmental impacts. Otherwise, not specified.	Disposal of materials can't be detrimental to the public interest.	The leasing program must consider the environmental value of renewable and nonrenewable resources and the environmental impact of exploration and development. The timing and location of leasing must balance the potential for environmental damage, the potential for the discovery of oil and gas, and the potential for adverse impacts on the coastal zone. Detailed environmental studies required prior to leasing. Monitoring continues during the term of the lease to identify and measure changes in environmental quality.	NOAA must prepare an environmental impact statement when issuing a permit or license. Stable reference areas are to be established by international agreement. All permits and licenses are conditioned on protection of the environment and conservation of resources.

Table C-1.—Comparison of Federal Mineral Statutes—Continued

	Entry and patent system	Mineral leasing systems	Materials sale system	Continental shelf leasing system	Deep seabed system
State and Public Involvement	Activities are subject to State and local laws not inconsistent with the laws of the United States.	Statute may not be construed as affecting the right of State or local governments to regulate or tax lessees of the United States. Land use plans for coal leasing are to be prepared in consultation with State agencies and the public. Proposed coal leases in national forests must be submitted to the governor of the affected State for review. If the governor objects, leasing is delayed for six months while the Secretary reconsiders the lease on the basis of the governor's comments.	Disposals from land withdrawn in aid of a State, municipality, or public agency can be made only with the consent of the State, municipality, or agency.	State civil and criminal laws not inconsistent with Federal law apply to those areas of the continental shelf which would be within the State if its boundaries extended seaward. The Secretary shall enforce safety, environmental, and conservation laws in cooperation with the States. State comments are to be invited and considered when gas and oil leasing programs are prepared and when proposed lease sales and development and production plans are being reviewed. State recommendations are to be accepted if the Secretary determines that they provide a reasonable balance between the national interest and the well-being of State citizens. Activities affecting land or water use in the coastal zone of a State having a coastal zone management plan require State concurrence.	Public notice and comment (including hearings) are required when permits and licenses are issued, transferred, or modified.

SOURCE: Office of Technology Assessment, 1987.

deposits available only through prospecting permits and leases. This move was a major departure from earlier policy, replacing free entry and disposal with a discretionary system. As initially adopted, prospecting permits could be issued to the first qualified applicant wishing to explore lands whose mineral potential was unknown. Discovery of a valuable deposit entitled the prospector to a preference-right lease to develop and produce the mineral if the land was found to be chiefly valuable for that purpose. Known mineral lands could be leased by advertisement, competitive bid, or other methods adopted by the Secretary of the Interior.

Prospecting permits are no longer available for oil, gas, or coal. Lands known to contain these substances may be leased only by competitive bid. Non-competitive leases may be issued to the first qualified applicant for lands outside the known geologic structure of a producing oil or gas field. The Secretary has broad discretion to impose conditions for diligence, safety, environmental protection, rents and royalties, and other factors needed to protect the interest of the United States and the public welfare.

Like the Mining Law of 1872, the Mineral Leasing Act of 1920 is applicable only to the public domain (for the most part, land which has been retained in Federal ownership since its original acquisition as part of the territory of the United States). The Mineral Leasing Act for Acquired Land was enacted in 1947 and made the fuel, fertilizer, and chemical minerals in acquired land available under the provisions of the Leasing Act of 1920. Permits and leases on acquired land (mostly national forests in the Eastern States) can be issued only with the consent of the surface management agency and must be consistent with the primary purpose for which the land was acquired. Hardrock minerals in acquired national forests and grasslands are available under similar conditions.

Materials Sales System

The Materials Act of 1947 made "common varieties" of sand, stone, gravel, cinders, and clay in Federal lands available for sale at fair market value or by competitive bidding. The Surface Resources Act of 1955 removed these materials from entry and patent under the General Mining Law. The miner does not acquire a property right to the source of these materials, and the use of a site may be communal or nonexclusive. Governmental and nonprofit entities are not charged for material taken for public or nonprofit purposes.

Offshore Mineral Management

Outer Continental Shelf Lands Act

The Outer Continental Shelf Lands Act (OCSLA) was adopted in 1953 and provides for the leasing of mineral resources in submerged lands that are beyond State waters and subject to U.S. jurisdiction and control (table C-1). The law's primary focus is on oil, gas, and sulphur but Section 8(k) authorizes the Secretary of the Interior to lease other minerals also occurring in the outer continental shelf.

Oil and gas leases are granted to the highest bidder pursuant to a 5-year leasing program. The program is based on a determination of national energy needs and must also consider the effects of leasing on other resources, regional development and energy needs, industry interest in particular areas, and environmental sensitivity and marine productivity of different areas of the continental shelf. The size, timing, and location of proposed lease sales and lessees' proposed development and production plans are subject to review by affected State and local governments. Recommendations from State and local governments must be accepted if the Secretary determines that they provide for a reasonable balance between the national interest and the well-being of local citizens. A flexible bidding system is provided in which the royalty rate, cash bonus, work commitment, profit share, or any combination of them may be the biddable factor.

A comprehensive program is not required for minerals other than oil and gas, and bidding for leases is limited to the highest cash bonus. It is unclear to what extent the law's coordination and environmental protection provisions apply to these other minerals. Leases under OCSLA are not explicitly limited to U.S. citizens by the statute, but such a limitation has been imposed by regulation. See 30 CFR 256.35(b).

Deep Seabed Hard Minerals Resources Act

The fifth legal system was adopted in 1980 as an interim measure pending the entry into force of a law of the sea treaty binding on the United States. The Deep Seabed Hard Minerals Resources Act (DSHMRA) applies to the exploration for and commercial recovery of manganese nodules in the seabed beyond the continental shelf or resource jurisdiction of any nation. In contrast with the other laws, where the United States asserts jurisdiction based on territorial control, DSHMRA's

jurisdiction is based on the power of the United States to regulate the activities of its citizens outside its territory.

Licenses for exploration and permits for commercial recovery are granted by the Administrator of the National Oceanic and Atmospheric Administration for areas whose size and location are chosen by the applicant. The applicant must prove financial and technological capability to carry out the proposed work, and the designated area must comprise a "logical mining unit. The Administrator is required to prepare an environmental impact statement prior to granting a license or permit. To help gauge the effects of mining on the marine environment, stable reference areas are to be established by international agreement. Permits and licenses are conditioned on protection of environmental quality and conservation of the mineral resource.

Because the United States does not claim ownership of the seabed or minerals involved, DSHMRA does not require rent or royalties. Only an administrative fee, sufficient to cover the cost of reviewing applications, is

charged. In addition, a 3.75 percent tax on the value of the resource recovered is levied. Proceeds of the tax are assigned to a trust fund to be used if U.S. contributions are required once an international seabed treaty is in effect.

All commercial recovery must be by vessels documented under U.S. law. At least one U.S. vessel must be used to transport minerals from each mining site. Land processing of recovered minerals must be within the United States unless this requirement would make the operation uneconomical. Minerals processed elsewhere must be returned to the United States for domestic use if the national interest so requires.

Before the United States ratifies an international seabed treaty, DSHMRA calls for reciprocal agreements with nations that adopt compatible seabed regulations. The agreements would require mutual recognition of the rights granted under any license or permit issued by a reciprocating state. The United States has signed agreements with France, Italy, Japan, the United Kingdom, and West Germany.

Ocean Mining Laws of Other Countries

This appendix summarizes the seabed mining laws of 10 countries. Not all of these countries have declared Exclusive Economic Zones (EEZs); thus, their laws may be based on continental shelf or territorial claims. These statutes illustrate the range of choices available for developing marine minerals. The general comparison that follows analyzes the various provisions shared by many of the statutes, but three provisions in particular are of primary interest for assessing the U.S. seabed mining regime:

1. allocating the right to mine,
2. payment for the right to mine, and
3. the division of responsibility between national and state or provincial authorities.

Allocating the right to mine includes selecting the location and size of a mining site and choosing a mine operator. In all of the countries surveyed, the initiative for prospecting or mining lies with the applicant, who must prove technical and financial capacity for carrying out the proposed work. Competing applications for the same area are generally assigned on a first-come basis, but Australia, for one, is considering work-program bidding or cash bidding for cases where some competition is needed. The applicant-initiative system is modified by general requirements for shoreline and environmental protection, area and time limits, and project-specific conditions imposed after an application is reviewed.

Payment for the privilege to mine may include application fees, rents, royalties on the value of recovered minerals, a tax on gross or net income, or a combination of these. The rate of payment may be set by law or negotiated on a case-by-case basis. Some countries provide for periodic adjustment based on economic conditions or the market for the mineral being recovered. In addition to paying for the minerals removed, miners may be required to spend funds each year for exploration or development. Spending above the minimum annual requirement may be credited to future years, while spending less may require paying the difference to the government or forfeiting the right to prospect or mine. The United States appears to be the only country which has a cash competitive bidding process to award leases in offshore areas.

Three of the countries included in this review—Australia, West Germany, and Canada, have a federal system of government. Australia is developing a system of joint authority over the continental shelf beyond the territorial sea; the states or territories have jurisdiction over the territorial sea. In West Germany, the states regulate activities within territorial waters while the national

government has exclusive jurisdiction over the continental shelf beyond the territorial limit. Canada has not yet enacted offshore mining legislation, but the Ministry of Energy, Mines, and Resources is drafting a proposed statute. A division of authority between the national and provincial governments will be part of the new law.

Australia

Laws

- Australia claims a 3-mile territorial seal Under the Coastal Waters (State Powers) Act of 1981, onshore mining legislation in the states of New South Wales, Tasmania, South Australia, Western Australia, and the Northern Territory can be applied offshore. Activities would be regulated according to standard terms, including environmental conditions. Western Australia is currently revising a model State Minerals (Submerged Lands) bill, particularly in regard to registration and transfer of leases. A version to be circulated to the States and Commonwealth may be ready in early 1987. Although some states are concerned that they cannot process company applications, offshore state legislation will most likely not be enacted before 1988.²
- In 1967, Australia passed a continental shelf act, based on Geneva provisions, for petroleum. In 1981, the Submerged Lands Act, which has a “degree of complementarity” with petroleum legislation³, was passed to cover other seabed minerals.⁴ However, the complementary state legislation necessary to implement it has not been passed yet.⁵
- Australia has not declared an EEZ.⁶

Jurisdiction

- Territorial waters: The adjoining state/territory has jurisdiction over minerals development.⁷
- Continental shelf: Offshore activities are administered by a Joint Authority, including a Common-

¹ Law of the Sea Bulletin, December 1983, No. 2, Off Ice of Special Representative of the Secretary-General for the Law of the Sea, United Nations (83-35821), p. 13.

² Letter from David Truman, Assistant Secretary, Minerals Policy Branch, to OTA, Oct. 3, 1986.

³ Letter from the Australian Department of Resources and Energy to OTA through Science and Technology Counselor J. R. Hlubucek, *Australian Embassy*, May 28, 1987.

⁴ Letter from Geoffrey Dabb, Legal Counsel, Australian Embassy to OTA, Oct. 6, 1986.

⁵ Truman, *op. cit.*

⁶ Law of the Sea Bulletin, 1983, *op. cit.*, p. 4.

⁷ Hlubucek, *op. cit.*

wealth Minister for Resources and Energy and a State Mines Minister. "The adjoining State Minister supervises day-to-day administration and serves as an industry contact. The Commonwealth minister is consulted on important issues and has the final authority in cases of disagreement.⁸

Permit Process

- **Exploration:** If a company wishes to explore for minerals (defined to include sand, gravel, clay, limestone, rock, evaporates, shale, oil-shale, and coal, but not petroleum¹⁰) in the ocean, it must apply to the Designated Authority (a State Minister charged with the responsibility by that State's Parliament¹¹) for an exploration permit. If the area of the application is on the seaward side of the outer limit of the territorial sea, the Joint Authority decides whether or not to grant the permit.¹² The application must be accompanied by a work and expenditure plan, and information regarding the technical qualifications of the applicant, and technical advice and financial resources available to the applicant.
- **Exploitation:** Same¹⁴

Terms

- **Exploration:** A fee of \$3,000 (Australian dollars) is charged for an application to explore any number of blocks less than 500 (A block is bounded by adjacent minutes of longitude and latitude). The permit lasts for 2 years, and gives the right to explore and take samples of specified minerals.¹⁵ A permit can be renewed 4 times, for up to 2 years each time, for up to 75 percent of the area in the permit being renewed. An application must be accompanied by a report on past and projected work and expenditures and a fee of \$300.¹⁶
- **Exploitation:** Application for a production license is done in a manner very similar to that for an exploration permit. Once granted, it lasts for 21 years. An annual rent of \$100 per block is charged. Royalty rates are set by the Joint Authority; the value of the exploited mineral may be considered in setting the rate.¹⁷ Within the territorial sea,

royalties are shared with the Commonwealth. 18 An application for a permit renewal must be accompanied by a \$300 fee.¹⁹

There is no competitive allocation mechanism in the unproclaimed Minerals (Submerged Lands) Act as it stands. However, at the recent meeting of Commonwealth and State officials, it was agreed that provisions should be made for competitive allocation. Generally, permits will be allocated on a first-come basis. In cases where some competition is needed, competitive allocation will generally use a work program bidding system, but provision for a cash bidding approach is being considered.

The Minerals (Submerged Lands) Act does not contain a royalty regime. At the officials' meeting, it was agreed that the endorsement of Ministers would be sought for the adjacent state to apply their onshore royalty regime to minerals won from the sea bed within the outer limit of the territorial sea. For minerals won from the sea bed on the seaward side of this limit, the commonwealth intends to apply a profits-based royalty. State royalties vary with the state and the mineral concerned, and in some cases profits-based royalties may be used, in other cases ad-valorem royalties or set tonnage rate royalties may be set. However, this does not preclude the states from opting for a profits-based royalty.

Conditions

Unreasonable interference with navigation, fishing, conservation of resources, and other lawful operations is prohibited.²⁰ Environmental assessment is generally the concern of the adjacent state. However, where mining impinges on commonwealth functions, assessment may be required by the appropriate commonwealth authority (there are arrangements to ensure that the assessments can be carried out jointly in most cases).

Section 105 further delineates regulations which the Governor General may promulgate under this law, concerning matters such as safety and conservation.²¹

Activities

Australia has explored for tin, monazite, phosphorite, rutile, and zircon.²² Private companies have been granted exploration licenses under current state onshore mining acts for aggregate and mineral sands off the coast

⁸1981 Minerals (Submerged Lands) Act, Section 8.

⁹Hlubucek, *op. cit.*

¹⁰1981 Minerals (Submerged Lands) Act, Section 3.

¹¹Hlubucek, *op. cit.*

¹²1981 Minerals (Submerged Lands) Act, Section 23.

¹³*Ibid.*, Section 24.

¹⁴*Ibid.*, Sections 31 and 32.

¹⁵*Ibid.*, Sections 26 and 27.

¹⁶*Ibid.*, Sections 28 and 29.

¹⁷*Ibid.*, Sections 31 '35.

¹⁸Hlubucek, *op. cit.*

¹⁹1981 Minerals (Submerged Lands) Act, Section 36.

²⁰*Ibid.*, Section 75.

²¹*Ibid.*

²²P. Hale and P. McLaren, "A Preliminary Assessment of Unconsolidated Mineral Resources in the Canadian Offshore," *The Canadian Mining and Metallurgical Bulletin*, September 1984, p.10.

of New South Wales. Production licenses have also been issued for dredging limestone off the Queensland and Western Australian coasts. Permit applications have been received for areas off the Western Australia and Northern Territory coasts for which the minerals have not been specified".

Public sector involvement in exploration and exploitation is not expected.²³

Canada

Laws

- Canada claims a 12-mile territorial sea.
- Continental shelf: Legislation was passed in June, 1969, as the Oil and Gas Production and Conservation Act.
- Canada has not declared an EEZ, but it does have a 200-mile fisheries zone.²⁴
- Currently, regulations for offshore mining could be promulgated under the Public Lands Grants Acts (The Ministry of Energy, Mines, and Resources has jurisdiction south of 60°; the Ministry of Indian and Northern Affairs has jurisdiction north of 60°). However, the Ministry of Energy, Mines, and Resources is in the process of drafting legislation which would be specifically applicable to offshore mining of hard minerals; the objective is to develop an 'adequate basis in law' for ocean mining. The law will address administration and management, disposition of mineral rights, royalties, and environment and fisheries. Plans call for the legislation to be written by the end of 1987; the Cabinet will make the final decision as to whether the new legislation should be introduced in Parliament. The recent Mineral and Metals Policy of Canada officially announced the Government intent to establish a legal and regulatory regime to maximize benefits from offshore mining. It seeks to develop "a simple, uniform, cooperative management system for mining development activities across all areas of the Canadian Continental Shelf."²⁵

Jurisdiction

The Canadians hope to formulate a regulatory scheme that can be applied regardless of who has jurisdiction over mining activities. However, the desired mechanism is one of cooperation with the provinces.

The Canadians take a "single window approach" to regulation, allowing companies to apply to a single gov-

ernment agency for exploration and/or exploitation permits. The rationale for this approach is that a simpler, stream-lined permitting process will encourage industry activity.

Permit Process

✚ **Exploration:** Companies must submit a proposal to the appropriate agency. This agency in turn follows the environmental assessment and review process which allows the contact agency to communicate with the Departments of Environment, Fisheries and Oceans, and Transport for project approval. However, the contact agency has final authority to approve or disapprove the project. This approach reflects the Canadian desire to treat environmental concerns as mandatory concerns and of equal importance with economic development. Thus, potential negative effects on the environment are reviewed at an early stage of project planning.

Conditions

Environmental conditions are considered through the Environmental Assessment and Review Process.

The government sees itself as "facilitator" of entrepreneurial interests. As facilitator, it has two main functions: 1) to eliminate structural barriers, i.e. by creating a regulatory scheme (since the lack of one is seen as a barrier to activity), and 2) to provide fundamental information about ocean mining.

Activities

Currently, mining activity is "on hold." The government will not prevent anyone from exploring, but is not issuing any mining permits. However, the government is suggesting companies submit mining applications, to protect any 'first in line' advantage when applications are processed. In the past, sand and gravel were mined in the Beaufort Sea to construct oil drilling platforms. Permits issued for this activity were subject to requirements equivalent to obtaining land use permits.

France

Laws

- France claims a 12-mile territorial sea.²⁶
- France declared its rights over the continental shelf on December 30, 1968.²⁷

²³Law of the Sea Bulletin, 1983, op. cit., p. 11

²⁴The Territorial Sea and Fishing Zones Act, as amended, 1979.

²⁵The Mineral and Metals Policy of the Government of Canada, Department of Energy, Mines, and Resources, May 1987, p. 8

²⁶Law of the Sea Bulletin, 1983, op. cit., p. 31.

²⁷Continental Shelf Law, Dec. 30, 1968 (no 68- 1181)

Ž France declared an EEZ on July 16, 1976. The law states that the provisions of the Continental Shelf law are applicable to the EEZ.

Jurisdiction

- Continental shelf: The central government appears to have complete jurisdiction over the continental shelf. The application of the continental shelf law is to be set by decree of the Conseil d'Etat.²⁸ The Directeur des Mines and the Directeur des Carburants, supervised by the Conseil General des Mines, administer French mining laws. All are located within the Ministère du Développement Industriel et Scientifique.²⁹

Permit Process

- Exploration or exploitation: Permits must be accompanied by a work program, submitted 45 days in advance of the proposed activity. The program is reviewed by a commission, including representatives from the Ministries of Economy and Finances, Telecommunication, and Maritime Policy. The chief of mines may solicit the opinion of these representatives in writing; however, if anyone objects to the proposal, the representatives must convene.³⁰

Terms

- Ž Exploration: Nonexclusive prospecting permits are issued.³¹ [Details regarding duration, rights, size and fees are unknown.]
- Exploitation: There are three types of mining titles: 1) provisional authorization pending the grant of a concession, 2) a mining concession, and 3) exploitation permit. Concessions are free and last in perpetuity. Permits are valid for 5 years, renewable for 2 more 5-year terms; a small indemnity must be paid to the owner of the surface area and the grantee is responsible for any damages resulting from his activities.³² A fixed royalty fee per metric ton is required for all minerals exploited; the value of the particular metal is taken into consideration. A Finance Law fixes the rate, as well as a formula for dividing revenues between central and local authorities³³

²⁸Ibid., Article 38.

²⁹N. Ely, Summary of Mining and Petroleum Laws of the World, Bureau of Mines Information Circular, 1974, U.S. Department of the Interior, Part 5, Europe, IC, 8613.

³⁰Decree of May 6, 1971 (no. 7 1-360), Articles 7 and 8

³¹N. Ely, Op. cit.

³²Ibid.

³³Continental Shelf Law, 1968, op. cit. Articles 21 and 23).

Conditions

Equipment must comply with special safety and maritime regulations.³⁴ The continental shelf law does not appear to specify other conditions.

Activities

France's activities have been limited to sand and gravel exploration and mining.³⁵

Federal Republic of Germany

Laws

- The FRG claims a 3-mile territorial sea.³⁶
- The FRG declared its rights over the Continental Shelf on January 20, 1964 and issued provisional regulations of rights on July 24, 1964.³⁷
- The FRG has not declared an EEZ.³⁸

Jurisdiction

- Territorial waters: Jurisdiction in German laws may be split one of three ways: 1) the federal government has exclusive jurisdiction, 2) the federal government makes the laws and the coastal states enforce them, 3) the federal government sets a framework and the coastal states make the laws. Offshore mining in territorial waters fits into category 2.³⁹
- Continental shelf: The federal government has exclusive jurisdiction.⁴⁰

Permit Process⁴¹

- Exploration and exploitation: Permits are awarded by the Chief Mining Board of Clausthal-Zellerfeld (for the technical and commercial aspects of mining) in conjunction with the German Hydrographic Institute (for the use and utilization of the waters and airspace above the continental shelf).⁴² Permits are awarded on a discretionary, informal basis, sometimes considering factors such as a company's

³⁴N. Ely, op. cit.

³⁵P. Hale and P. McLaren, op. cit.

³⁶Law of the Sea Bulletin, 1983, op. cit., p. 34.

³⁷Continental Shelf Declaration, Jan. 20, 1964, and the Act on Provisional Determination of Rights Relating to the Continental Shelf, July 24, 1964 (amended Sept. 2, 1974).

³⁸Law of the Sea Bulletin, 1983, Op. cit.

³⁹Mr. Max & h&n, Transportation Office, FRG Embassy, personal communication to OTA, Aug. 12, 1986.

⁴⁰Continental Shelf Declaration, 1964, op. cit., p. 37.

⁴¹The following details on process, terms, and conditions apply to the continental shelf.

⁴²Act on Provisional Determination of Rights Relating to the Continental Shelf, July 24, 1964; amended Sept. 2, 1974.

reputation for cooperativeness with the government. This approach derives from a historical tradition in which the King had personal authority over all mining operations. Competitive bidding is not used because it is seen as discouraging mining activity.⁴³

Terms

- Exploration: Permits are valid for 3 years, with extensions possible up to 5 years, if the Act referred to in Article 16, paragraph 2 of the Continental Shelf Declaration, has not yet come into force when the original permit expires.
- Exploitation: Royalty payments to the Chief Mining Board of Clausthal-Zellerfeld are required "where the competitive position of enterprises engaged in mining in German territorial waters would otherwise be substantially affected. The amount is to be based on mining dues which would 'customarily be payable at the point in German territorial waters nearest to the place of extraction. Royalty payments are transferred according to the Act of Article 16, paragraph 2.
[Details regarding exclusive and sampling rights, size and fees are unknown.]

Conditions

Permits may be issued subject to conditions and restrictions and may be subject to cancellation. The law does not specify what issues those conditions might address, although safety and technical aspects are among those considered.⁴⁴

Activities

Exploration has revealed that German waters have limited amounts of oil and gas and some coal.⁴⁵ The status of an application for the exploration of the continental shelf, filed by a consortium of companies, was uncertain as of 1980.⁴⁶ No exploration is currently taking place, as no finds are expected.⁴⁷

Sand and gravel extraction within the territorial seas is an established industry in the Baltic.⁴⁸

Japan

Laws

- Japan claims a 12-mile territorial sea.⁴⁹
- Japan does not claim a continental shelf or an EEZ.⁵⁰
- Japan has no comprehensive legislation dealing with offshore mining. The Mining Law, Quarry Law, and Gravel Gathering Law apply to offshore mining, depending on the type of mineral to be exploited. The Mining Law regulates activities on the continental shelf. The applicability of the other two laws outside the territorial waters has not been examined in detail.⁵¹

Jurisdiction

The government of Japan exercises jurisdiction over off-shore mining under the above-mentioned laws.⁵²

Permit Process

Under the Mining Law, application for permits for offshore mining are submitted to the Director-General of Ministry of Trade and Industry (MITI) regional bureau.

For quarrying, permits are granted by the Director-General of MITI regional bureau. Entrepreneurs register with the Governor of the prefecture, or with the Director-General of MITI regional bureau if their operations extend over more than one prefecture.

For gravel-gathering, issuance of permits is regulated on the prefectural level. Entrepreneurs register with the Governor of the prefecture, or with the Director-General of MITI regional bureau if their operations extend over more than one prefecture.⁵³

Terms

A fixed fee is assessed for each unit of aggregate mined.⁵⁴ Permits for exploration and exploitation are issued separately under the Mining Law. One permit covers both exploration and exploitation under the Quarry Law and the Gravel Gathering Law.

Duration: Permits for exploration are valid for two years with two possible extensions; no limit in duration for permits for exploitation (Mining Law). Permits are valid up to 20 years with possible extensions (Quarry

⁴³M. Kehden, *op. cit.*

⁴⁴M. Kehden, *op. cit.*

⁴⁵*Ibid.*

⁴⁶Marine Aggregate Project, EIS, Vol.1, February 1980, Consolidated Cold Fields Australia Ltd and ARC Marine Ltd

⁴⁷M. Kehden, *op. cit.*

⁴⁸Marine Aggregate Project, *op. cit.*

⁴⁹Law of the Sea Bulletin, 1983, *op. cit.*, p. 39.

⁵⁰*Ibid.*

⁵¹Letter from Kaname Ikeda, Science Office, Embassy of Japan, to OTA, June 15, 1987.

⁵²*Ibid.*

⁵³Ikeda, *op. cit.*

⁵⁴*Ibid.*

Law). No specific provisions (Gravel and Gathering Law).

Maximum permit area: 35,000 ares (Mining Law);⁵⁵ no specific provisions (Quarry Law, Gravel Gathering Law).

Permits are exclusive (Mining Law, Quarry Law) .5'

Conditions

Factors which are considered in deciding on the issuance of permits are: health and sanitary considerations, unreasonable interference with other industrial uses, and compliance with public welfare.

Factors which are considered in regulating mining activity are: whether a firm is part of an association, exclusivity, fishing rights, location (minimum distance from shore and minimum water depth), conflicting uses, prohibited areas (seaweed 'plantations' and drag net areas), buffer zones (sometimes greater than 500m between zones), mining methods (must be sand pump or clam shell), quantity, duration of license, uses, and market area.⁵⁷

Activities

Activity is limited to sand and gravel, 94 percent of which occurs in Kyushu and offshore the Seto Operations.⁵⁸ There is also some iron sand mining in the Prefecture of Shimane.

*Netherlands*⁵⁹

Laws

- The Netherlands recently expanded its territorial sea to 12 miles. A law for sand and gravel extraction within this area exists. By 1988 or 1989, this law will be extended to the continental shelf, based on the provisions of the 1958 Geneva Convention.
- The Netherlands Continental Shelf Act applies only to oil and gas.
- The Netherlands has no declared EEZ, because the government does not consider the EEZ to be customary international law yet.

⁵⁵3.5 square kilometers.

⁵⁶Ikeda, *op. cit.*

⁵⁷T. Usami, K. Tsurusaki, T. Hirota, et al., "Seafloor Sand Mining in Japan," in "Proceedings of Marine Technology '79—Ocean Energy" Marine Technology Society, Washington, DC, pp. 176-189.

⁵⁸Ibid.

⁵⁹This information was obtained through *interviews* with Mr. Wim J. Van Teeffelen, Assistant Attache for Science and Technology, Royal Netherlands Embassy, and Mr. Henk Van Hoom from the Ministry of Transportation and Waterworks, Directorate for the North Sea.

Jurisdiction

- Territorial waters: The central government has jurisdiction since provinces in the Netherlands have little power. The Ministry of Transport and Public Works issues permits for mining within the 12-mile zone.
- Continental shelf: The central government has jurisdiction. The Department of Treasury issues permits.

Permit Process

Exploration and exploitation: If a company wishes to extract sand, it approaches the appropriate government agency with its request. As long as a company does not violate any of the informal conditions and criteria, it is granted a permit. Since few companies are interested and potential mining areas are plentiful, companies do not have to bid competitively for mining permits.

Terms

- Exploration: [Details on duration, exclusivity and sampling rights, size, and fees are unknown.]
- Exploitation: Royalties must be paid. [Details on rates, duration, exclusivity, size, and fees are unknown.]

Conditions

Currently, informal policy criteria guide the agency's decisions to issue permits. In the Netherlands, one learns from childhood about the importance of preserving the coastal and ocean environment. The most important consideration is distance from the coastline of the proposed activity (must be no closer than 20 km to the coast); since the Netherlands is 2/3 below sea level, it is crucial to prevent coastal erosion. Some areas, such as the Waddensea area in the north, are off limits even though a great deal of sand is available, for environmental reasons (wetlands, seals, and nursery grounds for North Sea fish). Conflicts with pipelines, the environment, and fisheries are also considered; these conflicts are rare, however, because activity is limited. A third consideration is the type of technology the company proposes to use. (i. e., thin layer dredging or deep hole dredging; the former is currently preferred)

The Ministry of Transport and Public Works is currently working to formalize these policy criteria, which center around environmental concerns. The Ministry is examining the environmental consequences of mining in different areas. This will guide the choice of future mining sites and types of technologies.

Activities

Only sand and gravel, and mostly the former, is currently being extracted. No other economic minerals are expected to be found in Dutch waters. Few companies are involved and not much expanded activity in the future is anticipated unless land mining becomes very restricted.

Sand is extracted either from areas where it is naturally abundant or from shallow channels in the North Sea which need to be dredged anyway to allow large ships through (e. g., on the approach to Amsterdam). Activity takes place fairly close to shore because of transport requirements.

Norway

Laws

- Territorial sea and continental shelf: Norway passed, on June 21, 1963, Act No. 12, relating to Scientific Research and Exploration for and Exploitation of Subsea Natural Resources other than Petroleum Resources. On June 12, 1970, a Royal Decree was issued, setting provisional Rules for the Exploration for Certain Submarine Natural Resources other than Petroleum.
- Norway declared an Exclusive Economic Zone on December 17, 1976.⁶⁰

Jurisdiction

Under the Act of June 21, 1963, the King has the authority to issue exploration and exploitation permits and make regulations, in regard to both territorial seas and the continental shelf.⁶¹

Permit Process

Unknown

Terms

- Exploration: The Ministry of Industry may grant two year licenses for exploration of certain submarine natural resources. An application must include a description of the method of proposed exploration. The license does not give exclusive rights or guarantee exploitation rights.⁶²

⁶⁰Act of Dec 17, 1976, Economic Zone of Norway.

⁶¹Act No. 12, June 21, 1963, Scientific Research and Exploration for and Exploitation of Subsea Natural Resources other than Petroleum Resources

⁶²Royal Decree, June 12, 1970, provisional Rules concerning Exploration for Certain Submarine Natural Resources other than Petroleum in the Norwegian Continental Shelf, etc

Conditions

Exploration: Activities must avoid disturbing shipping, fishing, aviation, marine fauna or flora, submarine cables, etc.⁶³

Thailand

Laws

- Thailand has a 12-mile territorial sea.⁶⁴
- Thailand has declared a continental shelf.⁶⁵
- Thailand has not declared an EEZ.⁶⁶
- Offshore mining is governed by the Minerals Act B.E. 2510, 1967, as amended by the Minerals Act No. 2, 1973 and the Minerals Act No. 3, 1979. This act also covers onshore mining.⁶⁷

Jurisdiction

The government has exclusive ownership of all minerals "upon, in or under the surface of public domain and privately owned land. The Minerals Act is administered by the Department of Mineral Resources within the Ministry of Industry."⁶⁸

Permit Process

Unknown for both exploration and exploitation

Terms

- Exploration: There are three types of permits:
 1. The local District Mineral Resources Officer, on behalf of the central government, can issue a one-year nonrenewable prospecting license for a prescribed fee. The mineral of interest and the area to be prospected must be specified.
 2. Exclusive Prospecting Licenses are granted by the Minister of Industry, although applications are filed with the District Officer. The license is usually valid for 1 year, but for no more than 2. It is exclusive and non-transferable. The maximum permit area is 500,000 rai (1 rai is about 2/5 acre).

⁶³Ibid.

⁶⁴Law of the Sea Bulletin, 1983, op. cit. , p. 82.

⁶⁵Ibid.

⁶⁶Ibid., p. 63.

⁶⁷C.-U. Ruangsuvan (Department of Mineral Resources, Ministry of Industry, Thailand), "The Development of Offshore Mineral Resources in Thailand," in International Symposium on the New Law of the Sea in Southeast Asia, D. Johnston (ed.) (Dalhousie Ocean Studies Programme: 1983), pp. 83-87.

⁶⁸Ibid.

3. A Special Prospecting License is granted if the project requires substantial investment and special technology. The maximum permit area is 10,000 rai, but there is no limit on the number of permits for which one may apply. Permits are valid for 3 years, and may be renewed for no more than 2 years. A certain amount of activity is required.⁶⁹
- Exploitation: Mining leases and concessions are issued by the Minister of Energy. An application must be made in a prescribed form and certain fees are required. The maximum mining area is 50,000 rai.⁷⁰ A prospector is entitled to a concession upon making a mineral discovery and showing financial ability. Royalty rates are fixed by the government and may vary by mineral and area. An annual rent may also be required. Concessions are for a 75-year term.

Conditions

Environmental considerations are minor. The country does not have comprehensive environmental legislation.⁷¹

Activities

Tin is the main mineral being extracted from the Gulf of Thailand and the Andaman Sea; activity has taken place since 1907. In 1976, onshore production was 20,000 tons while offshore was about 8,300. By 1980, onshore had only risen to 22,200 tons while offshore had jumped to 23,700.⁷²

United Kingdom

Laws

- A bill to extend the territorial sea from 3 to 12 miles has recently been passed.⁷³
- The United Kingdom claimed its continental shelf in 1964.⁷⁴
- The United Kingdom has not declared an EEZ.

Jurisdiction

- Territorial waters: Proprietary rights to the bed of the Territorial Sea form a part of the Crown Es-

tate. Under the Crown Estate Act of 1961 the Crown Estate Commissioners are charged with the management of the Estate which includes the rights to license mineral extraction on the Territorial Seabed but excluding oil, gas, and coal.

- Continental shelf: Rights to mining of minerals other than oil, gas, and coal on the continental shelf are granted to the Crown by the Continental Shelf Act, 1964. The Commissioners have the power to grant prospecting and dredging licenses.⁷⁵

Permit Process

- Exploration: Since experience has shown that prospecting usually does not conflict unacceptably with other ocean uses, no formal government consultation process is required to obtain a permit. However, the Crown Estate Commissioners do inform the Ministry of Agriculture, Fisheries and Food (MAFF) before issuing a license and the MAFF, after consultation with regional officials, will notify the company of potential objections. Bulk sampling requires separate authorization by the Commissioners. The MAFF may propose changes (e. g., in time, place or extraction method) in order to protect fisheries.⁷⁶
- Exploitation: Applications to the Commissioners are first sent to Hydraulics Research Limited to advise whether there is likely to be any adverse effect on the adjacent coastline. Only if their advice is favorable does the application proceed, and it is then forwarded to the Minerals Division of the Department of the Environment (DOE).⁷⁷ The DOE oversees the "Government View" procedure which includes consultation with other Government departments and agencies dealing with coast protection, fisheries, navigation, oil and gas, and defense interests. If any department has a substantive objection, it may discuss it informally with the company or with the Crown Estate Commissioners before reporting it to the Department of the Environment.⁷⁸ The Department ultimately makes a recommendation to the Commissioners.

Terms

- Exploration: Licenses are issued for either 2 or 4 years and are not transferable. They permit use of

⁶⁹Ibid.

⁷⁰Ibid.

⁷¹D. Johnston, Ocean Studies Programme, Dalhousie University, Halifax, Canada, personal communication to OTA, Aug. 15, 1986.

⁷²C. U. Ruangsuwan, *op. cit.*

⁷³Letter from the Foreign and Commonwealth Office of the United Kingdom, London, England to OTA through R. L. Embleton, British Embassy, May 15, 1987.

⁷⁴Law of the Sea Bulletin, 1983, *op. cit.*

⁷⁵D. Pasho, "The United Kingdom Offshore Aggregate Industry: A Review of Management Practices and Issues, Ministry of Energy, Mines and Resources Canada, January, 1986, p. 17.

⁷⁶Code of Practice for the Extraction of Marine Aggregates, December 1981, p. 10.

⁷⁷D. Pasho, p. 19.

⁷⁸Code of Practice, p. 11.

seismic and core-sampling techniques and limited bulk sampling by dredger (up to 1,000 tonnes over the period of the licence). The license fee charged by the Crown Estate is on a sliding scale depending on the size of area. Exploration licences are nonexclusive and are normally renewable.⁷⁹

- **Exploitation:** Licenses are granted on a continuing basis but may be terminated at 6 months' notice. They are expressed to be nonexclusive but as far as possible each area is granted to a single operator. A maximum annual removal limit is stipulated. Royalties are payable on the actual quantity removed from the seabed but a dead rent of 20 percent of the maximum permissible tonnage multiplied by the current royalty rate is charged whether or not any material is removed. Royalty rates are reviewed periodically but are indexed in the Retail Price Index in the intervening years. The current royalties represent about 5 percent of the selling price of the material at the wharf of landing.⁸⁰

Conditions

- **Exploration:** Drilling and sampling near cables is restricted. 'Unjustifiable interference' with navigation, fishing or conservation of living resources is prohibited. The company must provide the Commissioners with reports on operations and a full report on prospecting results including geophysical profiles.
- **Exploitation:** An applicant must have held a prospecting license for the area. According to the 1977 Code of Practice, an applicant must have the necessary vessels, facilities, etc. to undertake work. The license specifies the maximum annual quantity to be dredged, and safety provisions. Licenses may be terminated by either party at 6-months' notice.

The Government View procedure is intended to resolve ocean use conflicts. Special attention is given to potential conflicts between fishing and mining in the Code of Practice. The government recognizes that both industries 'are legitimately exploiting the sea's resources. Therefore, it does not give special priority to any particular activity; for instance, the MAFF does not object to a mining license solely because it involves a fishery area.⁸¹

⁷⁹Foreign and Commonwealth Office, *op. cit.*

⁸⁰*Ibid.*

⁸¹*Ibid.*, p. 11

Activities

Sand and gravel dredging is a fairly well established activity, dating back to the mid-1920s.⁸² The attached table gives details on production at different mining sites. In 1985, marine sources provided about 14 percent of Britain's sand and gravel needs.

New Zealand

Laws

- New Zealand claims a 12-mile territorial sea.⁸³
- New Zealand declared its continental shelf in 1964.⁸⁴
- New Zealand declared an EEZ on September 6, 1977 with Act No. 28. Enactment of implementing legislation is pending international confirmation of the Law of the Sea Treaty.⁸⁵
- Legislation is currently being reviewed on a low-key basis by the Minister of Energy's office; a report to the ministers is pending.⁸⁶

Jurisdiction

Continental shelf: The Minister of Energy has exclusive authority to issue prospecting and mining licenses for minerals in the seabed or subsoil of the continental shelf.⁸⁷

Permit Process

Exploration and exploitation: Interested companies apply to the Minister of Energy and so long as they meet all the requirements, will be awarded a license. The company must show that it meets all the requirements by submitting a project assessment with its application (e. g., environmental assessment). The concerned agencies will become involved in the review process, but the company only deals directly with the Minister of Energy.⁸⁸

Terms

Exploration and exploitation: To date, only one prospecting license has been issued, so few precedents have been set. However, the granting process is likely to closely parallel that for oil and gas. Prospecting and

⁸²D. Pasho, p. 10.

⁸³Law of the Sea Bulletin, 1983, *op. cit.*, p. 62

⁸⁴*Ibid.*

⁸⁵Mr Pat Helm, New Zealand Embassy, and officials in Wellington, New Zealand, letter to OTA, Aug 1, 1986

⁸⁶*Ibid.*

⁸⁷New Zealand Continental Shelf Act, 1964, No 28, Section 5

⁸⁸*Ibid.*

Table D-1.—Ocean Mining Laws of Other Countries

Country	Permit process	TERMS						Conditions	Minerals
		Duration	Rights	Size	Fees	Royalties			
Australia:									
Exploration	Apply to designated authority Granted by joint authority	2 years	Exploration and sampling of specified minerals	Up to 500 blocks	\$3,000 (Australian)	—	No "unreasonable interference" with: • navigation • fishing • conservation • other legal activities	Tin, monazite, phosphates, rutile, zircon, sand, gravel	
Exploitation	Same as above	21 years	—	—	\$100/block	Set by joint authority	Same as above	Sand, gravel	
Canada:									
Exploration	Submit proposal to appropriate agency	No limit	—	—	—	—	Environmental assessment and review process	Gold, sand	
Exploitation	Same as above	Legislation currently being developed					Same as above	None currently	
France:									
Exploration	Must also be approved by prefecture	—	Nonexclusive by special agreement	—	—	—	Safety Maritime rules	Sand, gravel	
Exploitation	Same as above	Mining concession: 10 years Renewable 5 years Maximum 25 years	Same as above	—	Mining concession: None Permits: none In water	Fixed fee per month ton based on market value and Finance Law rates. Revenues divided between central and local governments	Same as above	Same as above	
Germany:									
Exploration	Granted by discretion of Chief Mining Board and Hydrographic Institute	3 years, extension up to 5 years	—	—	—	—	• Safety • Technical considerations	Sand, gravel	
Exploitation	Same as above	Same as above	—	—	—	Based on nearest territorial water dues	Same as above	Same as above	
Japan:									
Exploration	Granted by Governor of Prefecture or Minister General of MRE	a) Mining Law: 2 years b) Quarry Law: 10 years, may be extended	Exclusive	a) Mining Law: 3.5 km ² b) Quarry Law: no specific provisions	—	—	• Defense from above • Association membership • Fishing • Buffer zoning • Technology used • Time of day • Quantity • Duration • Use	Sand, gravel, tin sand	
Exploitation	Same as above	a) Mining Law: 10 years b) Quarry Law: 20 years, may be extended	Exclusive	a) Mining Law: 3.5 km ² b) Quarry Law: no specific provisions	—	Fixed fee per unit aggregate mined	—	Same as above	
Netherlands:									
Exploration	Application evaluated by appropriate agency against informal criteria and conditions	—	—	—	—	—	• At least 20 km from coast • Use conflict: pipelines, environment, fisheries	Sand, gravel	

Table D-1.—Ocean Mining Laws of Other Countries—Continued

Country	Permit process	Terms				Royalties	Conditions	Minerals
		Duration	Rights	Size	Fees			
Exploitation	Same as above	—	—	—	—	Required	Same as above • Mining technology: thin layer dredging preferred	Same as above
New Zealand: Exploitation	Applications evaluated by Minister of Energy	—	Nonexclusive	—	—	—	• Safety • Must not interfere with: —marine environment —fishermen —navigation —research —defense —cables, pipelines	Phosphorite
Exploitation	Same as above	—	—	—	—	Required; paid to the Crown	Same as above	—
Norway: Exploitation	—	2 years	Nonexclusive	—	—	—	Must not interfere with: • shipping • fishing • aviation • marine life • cables • etc.	—
Thailand: Exploitation	—	Prospecting: 1 year, renewable Exclusive: 1 to 2 years Special: 3 years, renewable for 2 more	Not transferable	Prospecting: must specify Exclusive: 500,000 rai Special: 10,000 rai	Required	Diligence requirement	Environmental considerations minor	Tin
Exploitation	—	—	50,000 rai	Required	—	—	Same as above	Same as above
United Kingdom: Exploitation	No formal review requirement	2 years	Not transferable Sampling up to 1,000 tonnes	Two 600 km ²	Required	—	Must not interfere with: • navigation • fishing • cables • living resources	Sand, gravel
Exploitation	Application evaluated in turn by Hydraulics Research Station, Department of Environment in consultation with appropriate agencies. Final approval by Commissioners	year, renewable	Not transferable Exclusive	—	Dead rent on approved tonnage	Based on quantity, market price, etc.	• Must have held prospecting license • Competence • Maximum quantity • Safety	Same as above

mining licenses are granted separately, so legally, the right to prospect is not tied to the right to mine. Logically, however, a company which has invested in prospecting is likely to obtain a mining license. Furthermore, since the government is often a partner in prospecting operations, exploitation rights follow naturally. Licenses do not grant exclusive rights; however, not enough activity has taken place to make this a controversial issue.⁸⁹ [Details regarding duration, size, and fees are unknown.]

Royalties must be paid to the Crown by the operator. Rates are specified in the license. No mining license has been issued, so no basis for assessing royalties has been established.⁹⁰

Conditions

Any mining activities must disturb the marine environment and life as little as "reasonably possible," must not interfere with the rights of commercial fishermen, must comply with safety provisions of the 1971 Mining Act and 1979 Coal Mines Act.

⁸⁹Ibid.
⁹⁰Ibid

Activities must not violate any of the restrictive regulations set forth by the Governor-General, concerning navigation, fishing, conservation of living resources, national defense, oceanographic research, submarine cables, or pipelines. "Unjustifiable interference" with any of these activities is defined at the Governor-General's discretion.⁹¹ However, in practice, the details of regulations are specified in Parliamentary committees, in consultation with representatives from appropriate government branches (i. e., the Ministry of the Environment).⁹²

The Inspector of Mines, in consultation with the Ministry of Transport, Marine Division, and Ministry of Agriculture and Fisheries arbitrates conflicts between miners and commercial fishermen.⁹³

Activities

One license has been issued for the prospecting of phosphorite nodules.⁹⁴

⁹¹New Zealand Continental Shelf Act, Section 8.

⁹²P Helm, op. cit.

⁹³Ibid.

⁹⁴Ibid.

Appendix E

Tables of Contents for OTA Contractor Reports

Manned Submersibles and Remotely Operated Vehicles: Their Use for Exploring the EEZ

Frank Busby
Busby Associates, Inc.
576 S. 23rd Street
Arlington, VA 22202

Table of Contents

Applications
 Manned Submersibles
 Remotely Operated Vehicles
 Hybrid Vehicles
Advantages and Limitations
Capabilities
Vehicle Applications in the EEZ
 Regional Surveys/Reconnaissance
 Local Surveys
 Sampling
 In Situ Mineral Analyses
 Examples
Needed Technical Developments

Technologies for Dredge Mining Minerals of the Exclusive Economic Zone (EEZ)

M.J. Richardson
Consolidated Placer Dredging, inc.
17961A Cowan
Irvine, CA 92714
Edward E. Horton
Deep Oil Technology, Inc.
P.O. Box 16189
Irvine, California 92713
Arlington, VA 22202

Table of Contents

introduction
Placer Mining Technology
 Precious Minerals
 Heavy Minerals
 Industrial Minerals

Definitions
Bibliography
Dredge Mining Systems
 Bucket Ladder Dredge
 Bucket Dredges for Mining
 Suction dredges for Mining
 Beneficiation Systems
 Tailings Disposal
 Mining Control
Economics and Efficiency of Dredge Mining
 Operations
 Capital Costs
 Operating Costs
Placer Sampling Methods
 Initial Survey Scout Sampling
 Indicated Reserves
 Proven Reserves
 Drilling Systems
 Bulk Sampling
 Placer Sampling Equipment Comparison
 Evaluation Procedures
 Precious Minerals
 Heavy Minerals
 Industrial Minerals
 Applications to Offshore Deposits
Future Technologies for Offshore Dredge Mining

Offshore Titanium Heavy Mineral Placers: Processing and Related Considerations

Arlington Technical Services
4 Colony Lane
Arlington, MA 02174
W.W. Harvey and F.C. Brown

Table of Contents

Titanium and Associated Minerals
 Salient Features of the Industry
 Recent History of Titanium Sands Mining in the
 Us.
General Extrapolations to Offshore Deposits
 Typical Flow Sheets for Processing Ti/associated
 Heavy Mineral Sands
 Modifications for Processing an Offshore Deposit
 A Dune Sands Analog of the Postulated Offshore
 Deposit

Offshore Titanium Heavy Minerals Production Scenario

Approach to a Framework for Evaluation

Component Costs for Heavy Mineral Sands Mining and Processing

Ore Grades for Break-Even Production from Offshore

Ore Grade Requirements: Revised Basis and Approach

References

Tables

Figures

Appendix

Processing Considerations for Chromite Heavy Mineral Placers

Arlington Technical Services

4 Old Colony Lane

Arlington, MA 02174

W.W. Harvey and F.C. Brown

Table of Contents

Preliminary Notes

Synopsis' of U.S. Chromium Industry

Mining and Processing of the Black Sands

Production Potential of Offshore Chromite Placers

Costs for a Southwest Oregon Beach Sands Placer

Costs for an Offshore Chromite Heavy Mineral Placer

Effect of New Technologies

References

Tables

Figures

Offshore Phosphorite Deposits:

Processing and Related Considerations

Arlington Technical Services

4 Old Colony Lane

Arlington, MA 02174

W.W. Harvey and F.C. Brown

Table of Contents

Background and Perspectives

Initial Perspectives

Onshore/Offshore Comparisons

Development Incentives

Past Commercial Activities

Qualitative Economic Considerations

Broad Cost Comparison

Cost Offset Via Higher Ore Values

Phosphorite Placer Development

Prior Engineering/Economic Studies

References

Tables

Figures

Polymetallic Sulfides and Oxides of the U.S. EEZ: Metallurgical Extraction and Related Aspects of Possible Future Development

Arlington Technical Services

4 Old Colony Lane

Arlington, MA 02174

W.W. Harvey

Table of Contents

Foreword

Recent Literature

Polymetallic Sulfides

Subsea Occurrences

Terrestrial Deposits

Processing Technologies

Tables and Figures, Section II

Oxide Nodules and Crusts

Broad Intercomparisons

Major Processing and Marketing Issues

Recent Process-Related Studies

Figures, Section III

References

Appendix

Data Management in a National Program of Exploration and Development of the U.S. EEZ

Richard C. Vetter

4779 North 33rd Street

Arlington, VA 22207

Table of Contents

Introduction

Conclusions, Problem Areas, and Recommendations

Examination of Limiting Factors

Is Technology Limiting?

Is Understanding of Wise Data Management

Concepts Limiting?

Is Infrastructure Lacking?

Is Funding Limiting?

The Present-Situation-and the Near Future

Federal Agencies

Department of Commerce/National Oceanic and Atmospheric Administration

National Environmental Satellite, Data,
and Information Service
National Geophysical Data Center
National Oceanographic Data Center
National Ocean Service
National Marine Fisheries Service
Department of the Interior
Minerals Management Service
U.S. Geological Survey
National Aeronautics and Space Administration

U.S. Navy
State and Local Governments
Academic and Private Laboratories
Industry
Other Data Management Studies
Study Procedures
References
Appendices
Questionnaire
Contacts

OTA Workshop Participants and Other Contributors

Workshop Participants-

Technologies for Surveying and Exploring the Exclusive Economic Zone, Washington, D. C., June 10, 1986. Participants described and evaluated technologies used for reconnoitering the EEZ, including bathymetry systems, side-looking sonar systems, and seismic, magnetic, and gravity technologies.

Chris Andreasen
National Ocean Service, NOAA

Robert D. Ballard
Woods Hole Oceanographic Institution

John Brozena
Naval Research Laboratory

Gary Hill
U.S. Geological Survey, Reston

John La Brecque
Lamont-Doherty Geological Observatory

William M. Marquet
Woods Hole Oceanographic Institution

Don Pryor
Charting and Geodetic Services
National Ocean Service, NOAA

Bill Ryan
Lamont-Doherty Geological Observatory

Carl Savit
Western Geophysical Co.

Robert C. Tyce
Graduate School of Oceanography
University of Rhode Island, RI

Donald White
General Instrument Corporation

Site-Specific Technologies for Exploring the Exclusive Economic Zone, Washington, D. C., July 16, 1986. Participants described and evaluated technologies for coring, dredging, and drilling and technologies for electrical and geochemical exploration.

Roger Amato
Minerals Management Service

Alan D. Chave
AT&T Bell Laboratories

Michael J. Cruickshank
Consulting Marine Mining Engineer

Charles Dill
Alpine Ocean Seismic Survey, Inc.

Peter B. Hale
Offshore Minerals Section
Energy, Mines, and Resources Canada

W. William Harvey
Arlington Technical Services, VA

Edward E. Horton
Deep Oil Technology, Inc.

Jerzy Maciolek
Exploration Technologies, Inc.

J. Robert Moore
Department of Marine Studies
University of Texas, TX

John Noakes
Center for Applied Isotope Studies
University of Georgia, GA

William D. Siapno
Marine Consultant

Paul Teleki
U.S. Geological Survey, Reston, VA

John Toth
Analytical Services, Inc.

Robert Willard
U.S. Bureau of Mines, Minneapolis, MN

S. Jeffress Williams
U.S. Geological Survey, Reston, VA

Robert Woolsey
Mississippi Minerals Resources Institute, MS

Pacific EEZ Minerals, Newport, Oregon, November 20, 1986. Participants assessed knowledge of chromite sands, cobalt crusts, and polymetallic sulfides of the U.S. Pacific EEZ and evaluated existing and potential technology for mining and processing these deposits. Held in cooperation with the Hatfield Marine Science Center, Oregon State University.

Robert Bailey
Department of Land Conservation and
Development
State of Oregon

Thomas Carnahan
Bureau of Mines, Reno, NV

David K. Denton
Bureau of Mines, Spokane, WA

Don Foot
Bureau of Mines, Salt Lake City, UT

Steve Hammond
Vents Program, NOAA

Benjamin W. Haynes
Bureau of Mines, Avondale, AZ

James R. Hein
U.S. Geological Survey, Menlo Park, CA

Donald Hull
Oregon Department of Geology and Mineral
Industries, OR

Laverne Kulm
College of Oceanography
Oregon State University, OR

Charles Morgan
Manganese Crust EIS Project

Joseph R. Ritchey
Bureau of Mines, Spokane, WA

Reid Stone
Office of Strategic and International Minerals
Minerals Management Service

James Wenzel
Marine Development Associates, Inc.

Robert Zierenberg
U.S. Geological Survey, Menlo Park, CA

Data Classification, Woods Hole, Massachusetts, January 27, 1987. Participants assessed the effect that classification of bathymetric data and other types of oceanographic data may have on marine science activities. Held in cooperation with the Marine Policy and Ocean Management Center, Woods Hole Oceanographic Institution.

James Broadus
Woods Hole Oceanographic Institution

John Edmond
Department of Earth and Planetary Sciences
Massachusetts Institute of Technology, MA

Richard Greenwald
Ocean Mining Associates

James Kosalos
International Submarine Technology

Jacqueline Mammericks
Scripps Institution of Oceanography

Donna Moffitt
Office of Marine Affairs
Department of Administration

W. Jason Morgan
Department of Geological and Geophysical Sciences
Princeton University, PA

Peter A. Rona
Atlantic Oceanographic and Meteorological
Laboratories, NOAA

David Ross
Woods Hole Oceanographic Institution

Derek W. Spencer
Woods Hole Oceanographic Institution

Robert C. Tyce
Graduate School of Oceanography
University of Rhode Island, RI

Mining and Processing Placers of the Exclusive Economic Zone, Washington, D. C., September 18, 1986.

Participants critiqued an OTA working paper on the mineral resources of the U.S. Atlantic and Gulf coast EEZs. Technologies for offshore placer mining and for minerals processing were also discussed.

Richard A. Beale
Associated Minerals (U. S. A.) Ltd.

Michael J. Cruickshank
Consulting Marine Mining Engineer

Edward Escowitz
U.S. Geological Survey, Reston, VA

Andrew Grosz
U.S. Geological Survey, Reston, VA

Frank C. Hamata
Sceptre-Ridel-Dawson Constructors

Gretchen Luepke
U.S. Geological Survey, Menlo Park, CA

Ruud Ouwerkerk
Dredge Technology Corporation

Tom Oxford
U.S. Army Corps of Engineers

Richard Rosamilia
Great Lakes Dredge and Dock Co.

David Ross
Woods Hole Oceanographic Institution

John Rowland
Bureau of Mines, Washington, D.C.

Langtry E. Lynd
U.S. Bureau of Mines, Washington, D.C.

J. Robert Moore
Department of Marine Studies
University of Texas, TX

Scott Snyder
Department of Geology
East Carolina University, NC

George Watson
Ferroalloy Associates

S. Jeffress Williams
U.S. Geological Survey, Reston, VA

Environmental Effects of Offshore Mining, Washington, D. C., October 29, 1986. Surface, mid-water, and benthic impacts were assessed for both near-shore and open-ocean mining situations. Potential effects of offshore dredging on coastal processes were also addressed.

Henry J. Bokuniewicz
Marine Sciences Research Center
State University of New York at Stony Brook, NY

Michael J. Cruickshank
Consulting Marine Mining Engineer

Clifton Curtis
Oceanic Society

David Duane
National Sea Grant College Program, NOAA

Joseph Flanagan
Ocean Minerals and Energy, NOAA

Barbara Hecker
Lamont-Doherty Geological Observatory

Michael J. Herz
Tiberon Center for Environmental Studies
University of San Francisco, CA

Robert R. Hessler
Scripps Institution of Oceanography

Art Hurme
U.S. Army Corps of Engineers

Greg McMurray
Oregon Department of Geology and Mineral
Industries, OR

Ed Myers
Ocean Minerals and Energy, NOAA

John Padan
Ocean Minerals and Energy, NOAA

Andrew Palmer
Environmental Policy Institute

Dean Parsons
National Marine Fisheries Service, NOAA

David W. Pasho
Resource Management Branch
Energy, Mines, and Resources Canada

Mario Paula
New York District, U.S. Army Corps of Engineers,
NY

Richard K. Peddicord
Battelle NE, MA

Joan Pope
U.S. Army Corps of Engineers

Jean Snider
Ocean Assessment, NOAA

Other Contributors

Craig Amergian
Analytical Services, Inc.

Robert Abel
N.J. Marine Science Consortium, NJ

W.T. Adams
U.S. Bureau of Mines

Vera Alexander
University of Alaska

Chris Andreasen
National Oceanic and Atmospheric Administration

Jack H. Archer
Woods Hole Oceanographic Institution

Ted Armbrustmacher
U.S. Geological Survey, Denver, CO

Dale Avery
U.S. Bureau of Mines

Ledolph Baer
National Oceanic and Atmospheric Administration

Susan Bales
David Taylor Naval Ship Research and
Development Center

Bill Barnard
Office of Technology Assessment

Aldo F. Barsotti
U.S. Bureau of Mines

Dan Basta
National Oceanic and Atmospheric Administration

Alan Bauder
U.S. Army Corps of Engineers

Wayne Bell
University of Maryland, MD

Jeff Benoit
Massachusetts Department of Environmental
Quality and Engineering, MA

Rick Berquist
Virginia Institute of Marine Science, VA

Buford Holt
U.S. Department of the Interior

David Thistle
Department of Oceanography
Florida State University, FL

George D. F. Wilson
Scripps Institution of Oceanography

Thomas Wright
U.S. Army Corps of Engineers

Lewis Brown
National Science Foundation

Bill Burnett
University of Florida, FL

R.J. Byrne
Virginia Institute of Marine Sciences, VA

David Camp
Florida Department of Natural Resources, FL

Bill Cannon
U.S. Geological Survey, Reston, VA

Jim Cathcart
U.S. Geological Survey, Denver, CO

M. W. Chesson
Zellers-Williams Company

Michael A. Chinnery
National Geophysical Data Center

Joe Christopher
Gulf of Mexico Region, Minerals Management
Service

Jay Combe
U.S. Army Corps of Engineers, New Orleans
District, LA

Stephen G. Conrad
North Carolina Division of Land Resources, NC

Margaret Courain
National Environmental Satellite, Data, and
Information Service

Dennis Cox
U.S. Geological Survey, Menlo Park, CA

Michael Cruickshank
Consulting Marine Mining Engineer

Mike Czarnecki
Naval Research Laboratory

Lou J. Czel
E.I. du Pont de Nemours & Co.

James F. Davis
California Department of Conservation, CA

Mike De Luca
National Oceanic and Atmospheric Administration

John H. De Young, Jr.
U.S. Geological Survey, Reston, VA

John Delaney
University of Washington, WA

Bob Detrick
University of Rhode Island, RI

Captain Joseph Drop
National Environmental Satellite, Data and
Information Service

Barry Drucker
Offshore Environmental Assessment Div.

David Duane
National Sea Grant College Program

John Dugen
Arete Associates

Frank Eaden
Joint Oceanographic Institutions

R.L. Embleton
British Embassy

Bill Emery
National Center for Atmospheric Research

Robert Engler
U.S. Army Corps of Engineers

Herman Enzer
U.S. Bureau of Mines

William Erb
State Department,

Edward Escowitz
U.S. Geological Survey, Reston, VA

Robert H. Fakundiny
New York State Geological Survey, NY

Rich Fantel
U.S. Bureau of Mines, Denver, CO

Martin Finerty
Ocean Studies Board, National Academy of
Sciences

Joe Flanagan
National Oceanic and Atmospheric Administration

John E. Flipse
Texas A&M University, TX

Mike Foose
U.S. Geological Survey, Reston, VA

Eric Force
U.S. Geological Survey, Reston, VA

Linda Glover
U.S. Navy

John Gould
Institute of Ocean Sciences, England

James L. Green
National Space Science Data Center

Andrew Grosz
U.S. Geological Survey, Reston, VA

Kenneth A. Haddad
Florida Department of Natural Resources, FL

Robert Hall
Department of the Interior

Gary Hallbauer
Texas Sea Grant, TX

Erick Hartwig
Office of Naval Research

W. William Harvey
Arlington Technical Services, VA

G. Ross Heath
Oregon State University, OR

Barbara Hecker
Lamont-Doherty Geological Observatory

J.B. Hedrick
U.S. Bureau of Mines

George Heimerdinger
National Oceanographic Data Center, NE Liaison

P.O. Helm
Embassy of New Zealand

H. James Herring
Dynamics of Princeton, PA

Jerry Hilbish
University of South Carolina, SC

Gary Hill
U.S. Geological Survey, Reston, VA

Tom Hillman
U.S. Bureau of Mines, Spokane, WA

Jack Hird
Texas Gulf

Joe Hlubucek
Embassy of Australia

Porter Hoagland
Woods Hole Oceanographic Institution

Carl H. Hobbs
Virginia Institute of Marine Science, VA

Kent Hughes
National Oceanographic Data Center

Art Hurme
U.S. Army Corps of Engineers

Lee Hunt
Naval Studies Board, National Research Council

Michel Hunt
Minerals Management Service

Kaname Ikeda
Embassy of Japan

Roy Jenne
National Center for Atmospheric Research

Janice Jolly
U.S. Bureau of Mines

Jim Jolly
U.S. Bureau of Mines

Ellen Kappel
Lamont-Doherty Geological Observatory

Mary Hope Katsouros
Ocean Studies Board, National Research Council

Jeff Kellam
Georgia Department of Natural Resources, GA

Joseph T. Kelley
Maine Geological Survey

Terry Kenyon
Vitro Corporation

Randall Kerhin
Maryland Geological Survey

Donald G. Kesterke
U.S. Bureau of Mines, retired

Daniel Kevin
Office of Technology Assessment

Lee Kimball
Council on Ocean Law

Chuck Klose
NASA Jet Propulsion Laboratory

John Knauss
University of Rhode Island, RI

Skip Kovacs
Naval Research Laboratory

Kenneth Kvammen
L.A. County Dept. of Public Works, CA

Richard N. Lambert
Aero Service

Bill Langer
U.S. Geological Survey, Denver, CO

Raymond Lasmanis
Washington State Geologist, WA

Brad J. Laubach
Minerals Management Service

Stephen Law
U.S. Bureau of Mines, Avondale, AZ

Jim Lawless
National Oceanic and Atmospheric Administration

Wah Ting Lee
David Taylor Naval Ship Research and
Development Center

Peter Leitner
General Services Administration

Howard Levenson
Office of Technology Assessment

Ralph Lewis
Connecticut Department of Environmental
Protection

Bob Lockerman
National Oceanographic Data Center

Millington Lockwood
National Oceanic and Atmospheric Administration

J.R. Loebenstein
U.S. Bureau of Mines

Michael Loughridge
National Geophysical Data Center

J.M. Lucas
U.S. Bureau of Mines

Edwin E. Luper
Mississippi Bureau of Geology

Langtry Lynd
U.S. Bureau of Mines

Bruce Magnell
EG&G

R. Gary Magnuson
Coastal States Organization

Frank Manheim
U.S. Geological Survey, Woods Hole

Charles Mathews
National Ocean Industries Association

Samuel W. McCandless, Jr.
User System Engineering, Inc.

Bonnie McGregor
U.S. Geological Survey

Gregory McMurray
Oregon Department of Geology & Mineral
Industries

Michael Hunt
Minerals Management Service

Rosemary Monahan
Environmental Protection Agency, Region I

Carla Moore
National Geophysical Data Center

Peter Moran
Eastman Kodak Co.

S. P. Murdoch
Embassy of New Zealand

Nancy Friedrich Neff
University of Rhode Island, RI

Myron Nordquist
Kelley, Drye & Warren

Terry W. Offield
U.S. Geological Survey

Jim Olsen
U.S. Bureau of Mines, Minneapolis, MN

Tom Osborn
Chesapeake Bay Institute

Ned Ostenso
National Sea Grant College Program

Norm Page
U.S. Geological Survey, Menlo Park, CA

John Padan
National Oceanic and Atmospheric Administration

Tom Patin
U.S. Army Corps of Engineers

Jack Pearce
National Marine Fisheries Service

John Perry
Atmospheric Studies Board, National Research
Council

Hal Petersen
Battelle NE, MS

Richard A. Petters
Sound Ocean Systems, Inc.

Don Pryor
National Oceanic and Atmospheric Administration

Larry Pugh
National Oceanic and Atmospheric Administration

Tom Pyle
Joint Oceanographic Institutions

Ransom Reed
U.S. Bureau of Mines

R. Reese
U.S. Bureau of Mines

Joe Ritchey
U.S. Bureau of Mines, Spokane, WA

Donald Rogich
U.S. Bureau of Mines

Nelson C. Ross
National Oceanographic Data Center
West Coast Liaison

John Rowland
U.S. Bureau of Mines

Paul D. Ryan
Embassy of Japan

Carl Savit
Western Geophysical Co. of America

Frederick Schmidt
Ames Laboratory, Iowa State University, IA

Robert L. Schmidt
U.S. Bureau of Mines

Henry R. Schorr
Gulf Coast Trailing Company

Bill Siapno
Deepsea Ventures

Allen Sielen
Environmental Protection Agency, Office of
International Activities

E. Emit Smith
Geological Survey of Alabama, AL

Jean Snider
National Oceanic and Atmospheric Administration

David J. Spottiswood
Colorado School of Mines, CO

Sidney Stillwaugh
National Oceanographic Data Center Pacific NW
Liaison

Reid Stone
Minerals Management Service

William F. Stowasser
U.S. Bureau of Mines

William L. Stubblefield
National Oceanic and Atmospheric Administration

Tim Sullivan
Atlantic OCS Region, Minerals Management
Service

Bill Sunda
National Marine Fisheries Service

Nick Sundt
Office of Technology Assessment

John R. Suter
Louisiana Geological Survey, LA

George Tirey
Minerals Management Service

Tom Usselman
Geophysics Study Committee, National Research
Council
Gregory van der Vink
Office of Technology Assessment
Van Waddell
Science Applications Inc.
Mike Walker
Intermagnetics General Corporation
Maureen Warren
National Oceanic and Atmospheric Administration
Sui-Ying Wat
United Nations, Ocean, Economics and Technology
Branch
E. G. Wernund
University of Texas at Austin, TX
Hoyt Wheeland
National Marine Fisheries Service
Bob Willard
U.S. Bureau of Mines, Minneapolis, MN

S. Jeffress Williams
U.S. Geological Survey, Reston, VA
Stan Wilson
National Aeronautics and Space Administration
Robert S. Winokur
Office of the Chief of Naval Operations
Gregory Withee
National Oceanographic Data Center
W.D. Woodbury
U.S. Bureau of Mines
Tom Wright
U.S. Army Corps of Engineers
Jeffrey C. Wynn
U.S. Geological Survey
Dave Zinzer
Minerals Management Service
Philip Zion
NASA Jet Propulsion Laboratory

Acronyms and Abbreviations

AEM	—Airborne Electromagnetic Bathymetry	1ST	—International Submarine Technology, Ltd.
AOML	—Atlantic Oceanographic and Meteorological Laboratories	ITA	—International Trade Administration
BOF	—Basic Oxygen Furnace	JOI	—Joint Oceanographic Institutions
BOM	—U.S. Bureau of Mines	LDGO	—Lamont-Doherty Geological Observatory
BPL	—Bone Phosphate of Lime	LOS	—Law of the Sea
BS ³	—Bathymetric Swath Survey System	LOSC	—Law of the Sea Convention
CAIS	—Center for Applied Isotope Studies	MB	—Marine Boundary Data
CALCOFI	—California Cooperative Fisheries Investigations	MCC	—Marine Core Curator
CDP	—Common Depth Point	MESA	—Marine Ecosystems Analysis Project
COE	—U.S. Army Corps of Engineers	MGF	—Miscellaneous Geology Files
CSO	—Coastal States Organization	MIPS	—Mini-Image Processing System
CZMA	—Coastal Zone Management Act	MM	—Marine Mineral Data
DGS	—Digital Grain Size	MMS	—Minerals Management Service
DMRP	—Dredged Material Research Program	MOU	—Memorandum of Understanding
DOD	—U.S. Department of Defense	MSR	—Marine Seismic Reflection
DOE	—U.S. Department of Energy	NAS	—National Academy of Science
DOI	—U.S. Department of the Interior	NASA	—National Aeronautics and Space Administration
DOMES	—Deep Ocean Mining Environmental Study	NACOA	—National Advisory Committee on Oceans and Atmosphere
DSHMRA	—Deep Seabed Hard Minerals Resources Act	NCAR	—National Center for Atmospheric Research
DSL	—Deep Submergence Laboratory	NEPA	—National Environmental Policy Act
EEZ	—Exclusive Economic Zone	NESDIS	—National Environmental Satellite Data and Information Service
EIS	—Environmental Impact Statement	NGDC	—National Geophysical Data Center
EPA	—U.S. Environmental Protection Agency	NMFS	—National Marine Fisheries Service
ERM	—Exact Repeat Mission	NMPIS	—National Marine Pollution Information System
FOB	—Free on Board	NOAA	—National Oceanic and Atmospheric Administration
FWS	—U.S. Fish and Wildlife Service	NOAC	—National Operations Security Advisory Committee
GEODAS	—Geophysical Data System	NODC	—National Oceanographic Data Center
GEOSAT	—U.S. Navy Geodetic Satellite	NOMES	—New England Offshore Mining Environmental Study
GI	—General Instrument Corp.	NORDA	—Naval Ocean Research and Development Activity
GGB	—Gridded Global Bathymetry	NOS	—National Ocean Survey
GLORIA	—Geological Long Range Inclined Asdic	NOS/HS	—National Ocean Survey Hydrographic Surveys
GPS	—Global Positioning System	NOS/MB	—National Ocean Survey Multibeam EEZ Bathymetry
HEBBLE	—High Energy Benthic Boundary Layer Experiment	NRC	—National Research Council
HIG	—Hawaii Institute of Geophysics	NRL	—Naval Research Laboratory
HS	—Hydrographic Survey	NSF	—National Science Foundation
ICES	—International Council for Exploration of the Seas	NSI	—NASA Science Internet
IDOE	—International Decade of Ocean Exploration		
IGY	—International Geophysical Year		
IOS	—Institute of Oceanographic Sciences		
IP	—Induced Polarization		
ICES	—International Council for the Explorations of the Seas		

OAR	—Oceans and Atmospheric Research	SAR	—Systeme Acoustique Remorque
OCS	—Outer Continental Shelf	SASS	—Sonar Array Sounding System
OCSLA	—Outer Continental Shelf Lands Act	SeaMARC	—Sea Mapping and Remote Characterization
OCSEAP	—Outer Continental Shelf Environment Assessment Program	SP	—Self Potential
OMA	—Ocean Mining Associates	SPAN	—Space Physics Analysis Network
OMB	—Office of Management and Budget	TAMU	—Texas A & M University
OSIM	—Office of Strategic and International Minerals	TOGA	—Tropical Ocean Global Atmosphere Study
OSTP	—Office of Science and Technology Policy	UMI	—Underwater Mining Institute
ODP	—Ocean Drilling Program	USCG	—U.S. Coast Guard
OMA	—Ocean Mining Associates	UTM	—Universal Transverse Mercator
ONR	—Office of Naval Research	UNOLS	—University National Oceanographic Laboratory System
PGM	—Platinum Group Metal	USGS	—U.S. Geological Survey
PMEL	—Pacific Marine Environmental Laboratory	WADSEP	—Walking and Dredging Self-Elevating Platform
ROR	—Rate of Return	WOCE	—World Ocean Circulation Experiment
ROV	—Remotely Operated Vehicle	WHOI	—Woods Hole Oceanographic Institution
SAB	—Strategic Assessment Branch		

Conversion Table and Glossary

Conversion Table for Distances, Areas, Volumes, and Weights

1 inch = 2.54 centimeters	1 are = 100 square meters = 119.6 square yards
1 square inch = 6.45 square centimeters	1 statute mile = 0.86 nautical miles
1 cubic inch = 16.39 cubic centimeters	1 square statute mile = 0.74 square nautical miles
1 centimeter = 0.39 inches	1 statute mile = 1.61 kilometers
1 square centimeter = 0.15 square inches	1 square statute mile = 2.59 square kilometers
1 cubic centimeter = 0.06 cubic inches	1 nautical mile = 1.16 statute miles
1 foot = 0.30 meters	1 square nautical mile = 1.35 square statute miles
1 square foot = 0.09 square meters	1 nautical mile = 1.85 kilometers
1 cubic foot = 0.03 cubic meters	1 square nautical mile = 3.43 square kilometers
1 meter = 3.28 feet	1 kilometer = 0.62 statute miles
1 square meter = 10.76 square feet	1 square kilometer = 0.39 square statute miles
1 cubic meter = 35.31 cubic feet	1 kilometer = 0.54 nautical miles
1 yard = .91 meters	1 square kilometer = 0.29 square nautical miles
1 square yard = 0.84 square meters	1 short ton = 2000 pounds = 0.91 metric tons
1 cubic yard = 0.76 cubic meters	1 long ton = 2240 pounds = 1.02 metric tons
1 meter = 1.09 yards	1 metric ton = 1.10 short tons = 0.98 long tons
1 square meter = 1.20 square yards	
1 cubic meter = 1.31 cubic yards	

Glossary

Abyssal Plain: A flat region of the deep ocean floor.

Acid-Grade Phosphate Rock: Phosphate rock that can be used directly in fertilizer plants. A comparatively pure grade of phosphate rock that assays at 31 percent phosphorous pentoxide (P_2O_5), and is also called "fertilizer-grade" rock.

Acoustic: Of or relating to sounds or to the science of sounds.

Active Margin: The leading edge of a continental plate characterized by coastal volcanic mountain ranges, frequent earthquake activity, and relatively narrow continental shelves.

Alluvial Deposits: Secondary deposits derived from the fragmentation and concentration of chromite minerals from primary stratiform or podiform deposits. Alluvial deposits are either placers, e.g., beach sands which occur in Oregon and stream sand deposits in the eastern States, or laterites, which occur in north-west California and southwestern Oregon.

Anatase: One of two major crystalline modifications of titanium dioxide (TiO_2), the other being rutile.

Argon-Oxygen-Decarburization (AOD); Vacuum-Oxygen-Decarburization (VOD): Processes for removing carbon from molten steel without oxidizing large amounts of valuable alloying elements, especially chromium. AOD and VOD enable the use of lower grade, lower cost high-carbon ferrochromium.

Attenuation: A reduction in the amplitude or energy of a seismic or sonar signal, such as produced by divergence, reflection and scattering, and absorption.

Barrier Island: A long, narrow, wave-built sandy island parallel to the shore and separated from the mainland by a lagoon.

Bathymetry: The measurement of depths of water in the oceans. Also, the information derived from such measurements.

Beneficiation-Grade Phosphate Rock: Phosphate rock that assays at 10 to 18 percent phosphorous pentoxide (P_2O_5) and requires the removal of hydrocarbons and other impurities before processing in a chemical plant. It may be upgraded to acid grade or furnace feed quality.

Beneficiation: Improvement of the grade of ore by milling, flotation, gravity concentration, or other processes.

Benthos: the animals living at the bottom of the sea.

Bioassay: a method for semi-quantitatively measuring the effect of a given concentration of a substance on the growth of a living organism.

Biomass: The amount of living matter in a community or population of a single species. (It may be measured either by wet, dry, or ash-free [burned] weight.)

Calcium Phosphate: Any of the calcium orthophosphates that may be used for fertilizers, plastics stabilizers, pharmaceuticals, animal feeds, and toothpastes. They include acid calcium phosphate, calcium dihydrogen

- phosphate, monobasic calcium phosphate, monocalcium phosphate, and tricalcium phosphate.
- Cephalopods:** Marine mollusks including squids, octopuses, and Nautilus.
- Chromic Oxide:** A dark green amorphous powder that is insoluble in water or acids. Also known as chrome green. It is commonly used as a standard measure of chromium content in chromite.
- Chromite:** An iron-chromic oxide (chrome iron ore). A mineral of the spinel group, and the only mineral mined for chromium. "Chromite" is used synonymously for chromium ore and concentrates made from the ore used *in* commercial trade. When referring to the spinel mineral chromite, it is referred to as "chromite mineral."
- Conductivity:** The ratio of electric current density to the electric field in a material; the reciprocal of resistivity.
- Continental rise:** That part of the continental margin that is between the continental slope and the abyssal plain except in areas of an oceanic trench.
- Continental Shelf:** The part of the continental margin that is between the shore and the continental slope and is characterized by its very gentle slope.
- Continental Slope:** The relatively steeply sloping part of the continental margin that is between the continental shelf and the continental rise.
- Crustacean:** Jointed animals with hard shells. This group includes crabs, shrimp, lobsters, and barnacles.
- Deposit-Feeder:** An animal that feeds on particulate matter deposited on the seafloor.
- Detritus:** Particulate matter resulting from the degeneration and decay of organisms or inorganic substances in nature.
- Diversity:** a measure of the numbers and kinds of species found in a particular area.
- Dredging:** The various processes by which large floating machines, or dredges, excavate earth material at the bottom of a body of water, raise it to the surface, and discharge it into a hopper, pipeline, or barge, or return it to the water body after removal of ore minerals.
- Electrolytic Manganese Metal:** A relatively pure form of metal produced by the deposition of a metal on the cathode by passing an electric current through a chemical solution of manganous sulfate; at the same time electrolytic manganese dioxide (MnO_2) is formed at the anode.
- Fauna:** the animal life characteristic of a particular environment or region.
- Ferrochromium:** A crude ferroalloy containing chromium that is an intermediate iron-chromic product used in the manufacture of chromium steel.
- Ferromanganese Crusts:** Crusts of iron and manganese oxides enriched in cobalt that are found on the flanks of seamounts, ridges, and other raised areas of ocean floor in the central Pacific.
- Ferromanganese Nodules:** Concretions of iron and manganese oxides containing copper, nickel, cobalt, and other metals that are found in deep ocean basins and in some shallower areas of the oceanfloor.
- Ferromanganese:** A ferroalloy containing about 80 percent manganese and used in steelmaking. There are three grades: (1) High-Carbon (Standard)—74 to 82 percent manganese; (2) Medium-carbon—80 to 85 percent manganese; and (3) Low-carbon—80 to 90 percent manganese.
- Filter-Feeder:** an animal that feeds on minute organisms suspended in the water column by using some screening and capturing (filtering) mechanism.
- Flotation Separation:** A method of concentrating ore that employs the principles of interracial chemistry that separates the useful minerals in the ore from the waste by adding reagents or oils to a water slurry mixture of fine particles of ore and collecting the useful portion that "floats" to the surface in association with the oil or reagent.
- Full Alloy Steel:** Those steels may contain between one-half percent to nine percent chromium, but more commonly contain between one and four percent. Chromium is used to impart hardness.
- Furnace-Grade Phosphate Rock:** Phosphate rock that assays at 18 to 28 percent phosphorous pentoxide (P_2O_5). It may be charged directly to electric furnaces to produce slag and ferrophosphorus as byproducts and volatilized elemental phosphorus as the primary product.
- Gangue:** The nonmetalliferous or nonvaluable metalliferous minerals in an ore.
- Geomagnetic:** Pertaining to the magnetic field of the earth.
- Geophysics:** Study of the earth by quantitative physical methods (e. g., electric, gravity, magnetic, seismic, or thermal techniques).
- Grade:** The relative quantity or weight percentage of ore-mineral content in an orebody.
- Gradiometry:** Measurement of the difference in the magnetic or gravity field between two points, rather than the total field at any given point.
- Gravity Anomaly:** The difference between the observed value of gravity at a point and the theoretically calculated value. Excess observed gravity is positive and deficient observed gravity is negative.
- Hadfield Manganese Steel:** A steel containing 10 to 14 percent manganese; resistant to shock and wear.
- Ilmenite:** A black, opaque mineral consisting of impure $FeTiO_3$ that is the principal ore of titanium.
- Interferometry:** The precise measurement of wavelength, very small distances and thicknesses, etc. through the separation of light (by means of a sys-

tern of mirrors and glass plates) into two parts that travel unequal optical paths and when reunited consequently interfere with each other.

Invertebrate: an animal lacking a backbone and an internal skeleton.

Kroll Process: A reduction process for the production principally of titanium metal sponge from titanium tetrachloride by molten magnesium metal.

Larvae: free-living immature forms that have developed from a fertilized egg but must undergo a series of shape and size changes before assuming the characteristic features of the adult organism.

Laterite: Weathered material composed principally of the oxides of iron, aluminum, titanium, manganese, nickel and chromium. Laterite may range from soil-like porous material to hard rock.

Leucoxene: A mineral assemblage of intermediate titanium dioxide (TiO_2) content composed of rutile with some anatase or sphene. Usually an alteration product of ilmenite, with the iron oxide content having been reduced by weathering.

Macrofauna: animals barely large enough to be visible to the naked eye and not likely to be photographed from a meter or two. Average body length might be about 1 mm.

Magnetic Anomaly: The difference between the intensity of the magnetic field at a point and the theoretically calculated value. Anomalies are interpreted as to the depth, size, shape, and magnetization of geologic features causing them.

Manganese Ore: Those ores containing 35 percent or more manganese.

Manganese Dioxide: MnO_2 , a black, crystalline, water-insoluble compound used in dry-cell batteries, as a catalyst, and in dyeing textiles. Also known as "battery manganese."

Manganiferous Ore: Any ore important for its manganese content containing less than 35 percent manganese but not less than 5 percent. There are two types of manganiferous ore: (1) "Ferruginous ore"—containing 10 to 35 percent manganese; and (2) "Manganiferous iron ore"—containing 5 to 10 percent manganese.

Mining: The process of extracting metallic or nonmetallic mineral deposits from the earth. The process may also include preliminary treatment, such as cleaning or sizing.

Mollusk: a division of the animal kingdom containing clams, mussels, oysters, snails, octopuses, and squids; they are characterized by an organ that secretes a shell.

Nekton: Free-swimming aquatic animals.

Neutron Activation: Bombardment of a material by high-energy neutrons which transmute natural ele-

ments to gamma-ray-emitting isotopes of characteristic identity.

Ore: The naturally occurring material from which a mineral or minerals of economic value can be extracted at a reasonable profit.

Overburden: Loose or consolidated rock material that overlies a mineral deposit and must be removed prior to mining.

P_2O_5 : Phosphorus pentoxide, the standard used to measure phosphorus content in ores and products.

Passive Margin: The trailing edge of a continent located within a crustal plate at the transition between continental and oceanic crust and characterized by its lack of significant volcanic and seismic activity.

Pelagic: pertaining to the open ocean.

Perovskite: A natural, complex, yellow, brownish-yellow, reddish, brown, or black calcium-titanium oxide mineral.

Phosphate Rock: Igneous rock that contains one or more phosphorus-bearing minerals, e.g. phosphorite, of sufficient purity and quantity to permit its commercial use as a source of phosphatic compounds or elemental phosphorus.

Phosphorite: A sedimentary rock with a high enough content of phosphate minerals to be of economic interest. Most commonly it is a bedded primary or reworked secondary marine rock composed of microcrystalline carbonate fluorapatite in the form of layers, pellets, nodules, and skeletal, shell, and bone fragments.

Phylogeny: the evolutionary or ancestral history of organisms.

Phytoplankton: the plant forms of plankton.

Placer: Concentrations of heavy detrital minerals that are resistant to chemical and physical processes of weathering.

Placer: A mineral deposit formed by mechanical concentration of mineral particles from weathered debris. The mineral concentrated is usually a heavy mineral such as gold, cassiterite, or rutile.

Plankton: passively floating or weakly motile aquatic plants and animals.

Plate Tectonics: A model to explain global tectonics wherein the Earth's outer shell is made up of gigantic plates composed of both continental and oceanic lithosphere (crust and upper mantle) that "float" on some viscous underlayer in the mantle and move more or less independently, slowly grinding against each other while propelled from the rear by seafloor spreading.

Podiform-Type Deposits: Primary chromite mineral deposits that are irregularly formed as lenticular, tabular, or pod shapes. Because of their irregular nature, podiform deposits are difficult to locate and evaluate. Most podiform deposits are high in chromium,

- and are the only source of high-aluminum chromite. In the United States, they occur mostly on the Pacific Coast in California and Alaska.
- Polychaete:** a class of segmented marine worms.
- Polymetallic Sulfide:** A popular term used to describe the suites of intimately associated sulfide minerals that have been found in spreading centers on the ocean floor.
- Primary Productivity:** the amount of organic matter synthesized from inorganic substances in a given area or a measured amount of time (e. g., gm/m²/yr).
- Processing:** The series of steps by which raw material (ore) is transformed into intermediate or final mineral products. The number and type of steps involved in a particular process may vary considerably depending on the characteristics of the ore and the end product or products to be extracted from the ore.
- Pycnocline:** a vertical gradient in the ocean where density changes rapidly.
- Pyrolusite:** A soft iron-black or dark steel-gray tetragonal mineral composed of manganese dioxide (MnO₂). It is the most important ore of manganese.
- Reconnaissance:** A general, exploratory examination or survey of the main features of a region, usually preliminary to a more detailed survey.
- Refractory:** A material of high melting point, possessing the property of heat resistance.
- Remote Sensing:** The collection of information about an object by a recording device that is not in physical contact with it. The term is usually restricted to mean methods that record reflected or radiated electromagnetic energy, rather than methods that involve significant penetration into the earth.
- Resistivity:** The electrical resistance offered by a material to the flow of current, times the cross-sectional area of current flow and per unit length of current path; the reciprocal of conductivity.
- Resolution:** A measure of the ability of geophysical instruments, or of remote-sensing systems, to define closely spaced targets.
- Rhodochrosite:** A rose-red or pink to gray rhombohedral mineral of the calcite group: MnCO₃. It is a minor ore of manganese.
- Rhodonite:** A pink or brown mineral of silicate-manganese: MnSiO₃.
- Rutile:** Occurs naturally as a reddish-brown, tetragonal mineral composed of impure titanium dioxide (TiO₂); common in acid rocks, sometimes found in beach sands.
- Seafloor Spreading Center:** A rift zone on the ocean floor where two plates are moving apart and new oceanic crust is forming.
- Seamount:** A seafloor mountain generally formed as a submarine volcano.
- Seismic Reflection:** The mapping of seismic energy that has bounced off impedance layers within the earth.
- Seismic Refraction:** The transport of seismic energy through rock and along impedance layers.
- Silicomanganese:** A crude alloy made up of 65 to 70 percent manganese, 16 to 25 percent silicon, and 1 to 2.5 percent carbon; used in the manufacture of low-carbon steel.
- Sonar:** Sonic energy bounced off distant objects underwater to locate and range on them, just as radar does with microwaves in air.
- Stainless Steel:** Steel with exceptional corrosion and oxidation resistance, usually containing between 12 and 36 percent chromium. Chromium contents of 12 percent are required to be corrosion resistant. Some low-chromium stainless steels are produced (nine percent to 12 percent), but chromium content averages about 17 percent.
- Stratiform Deposits:** Primary chromite mineral deposits that occur as uniform layers up to several feet thick similar to coalbeds. Stratiform deposits generally contain chromite with low chromium-iron ratio, are comparatively uniform and extend over large areas. The chromite occurrences in the Stillwater Complex in Montana are characteristic of stratiform deposits.
- Stratigraphy:** Study of the order of rock strata, their age and form as well as their distribution and lithology.
- Substrate:** 1) The substance on or in which an organism lives and grows, 2) The underlying material (e. g., basalt) to which cobalt-rich ferromanganese crusts are cemented.
- Succession:** the gradual process of community change brought about by the establishment of new populations of species which eventually replace the original inhabitants.
- Superphosphate:** One of the most important phosphorus fertilizers, derived by action of sulfuric acid on phosphate rock. Ordinary superphosphate contains about 18 to 20 percent phosphorous pentoxide (P₂O₅). Triple superphosphate is enriched in phosphorus (44 percent to 46 percent P₂O₅) and is manufactured by treating superphosphate with phosphoric acid.
- Synthetic Rutile:** Rutile substitutes made from high-grade ilmenites by various combinations of oxidation-reduction and leaching treatments to remove the bulk of the iron.
- Taxonomy:** classification of organisms into groups reflecting their similarity and differences (Kingdom, Phylum, Class, Order, Family, Genus, Species).
- Thermocline:** a gradient in the ocean where temperature changes rapidly.
- Titanium Dioxide Pigment:** A white, water-insoluble powder composed of relatively pure titanium dioxide (TiO₂) produced commercially from TiO₂ minerals

ilmenite and rutile (both rutile and anatase “grades” are manufactured).

Titanium Slag: High titanium dioxide (TiO₂) slag made by electric furnace smelting of ilmenite with carbon, wherein a large fraction of the iron oxide is reduced to a saleable iron metal product.

Titanium Sponge: The primary metal form of titanium obtained by reduction of titanium tetrachloride vapor with magnesium or sodium metal. It is called sponge because of its appearance and high porosity.

Transponder: A radio or radar device that upon receiving a designated signal emits a signal of its own. Used for detection, identification, and location of objects, as on the seafloor.

Turbidity: cloudiness in water due to the presence of suspended matter.

Zooplankton: animal forms of plankton.

Index

- Ad Hoc Working Group on the EEZ, recommendations: 29
airlift systems: 19, 176-177
Albania: 87
Alvin: 145, 148, 151-152, 161, 245
AMAX Nickel Refining Co.: 89
Ambrose Channel: 231, 290
Amdril: 156-157
American Samoa: 293, 298
Analytical Services, Inc.: 159
andesites: 57
Anti-Turbidity Overflow System: 236
Arctic Research and Policy Act: 26
Arctic Research Commission: 26
ASARCO: 200
assistance to States: 34, 291
 legislative: 34, 291
 State-Federal Task Forces: 34, 291
Associated Minerals (U.S.A.): 105, 193
Association of American State Geologists: 267
at-sea mineral processing technology: 167, 185-192
Australia: 96, 99, 104, 174, 307, 317
 mining laws: 307-309
- Baffin Island: 161
barrier islands: 47
bathymetric data: 17, 22, 23, 132
 general: 17, 132
 security classification: 22, 23
Bathymetric Swath Survey System: 122, 128, 131, 256, 268
bathymetric systems: 124-131
 airborne electromagnetic bathymetry: 130
 Bathymetric Swath Survey System: 122, 128, 131, 256, 268
 Canadian Hydrographic Service: 130
 charts: 124, 128
 deep-water systems: 126-128
 General Instrument Corp.: 126, 128
 Hydrochart: 128, 256
 Larson 500: 130
 laser systems: 128
 passive multispectral scanner: 130
 Sea Beam: 122, 123, 126-128, 131, 256, 276
 seafloor mapping: 126, 131-132
 shallow-water systems: 128-131
 Sonar Array Sounding System: 126, 128, 132
 synthetic aperture radar: 130
 WRELADS: 130
beach erosion: 224
Becker Hammer Drill: 156-158
Bedford Institution of Oceanography: 161
benthic communities: 20
benthic environmental effects: 215, 223, 226-227, 243, 245
BIMA dredge: 169, 171, 200
Bone Valley Formation: 53, 56
borehole mining: 19
Botswana: 96
Brazil: 39, 41, 91, 94, 171
Brown & Root: 182
- California Cooperative Fisheries Investigations: 262
Canada: 13, 39, 45, 49, 51, 65, 96, 98, 99, 102, 104, 218, 309, 317
 mining laws: 309
Center for Applied Isotope Studies: 144
Challenger, HMS: 158
Challenger, space shuttle: 149
charting: 254-256
 funding: 254
 GLORIA program: 254-255
Chile: 98
chromite sands, seabed mining scenario: 196-199
 at-sea processing: 197
 costs: 198
 location and description: 196, 197
 mining technology: 197
 operation: 198
 profitability: 199
chromium, commodities: 91-93
 demand and technological trends: 93
 domestic production: 92
 domestic resources and reserves: 91
 foreign sources: 91
 properties and uses: 90, 91
 stockpile: 92
Clarion Fracture Zone: 122
Clipperton Fracture Zone: 122
coastal erosion, effects of dredging: 21
coastal plain: 42, 51, 52
Coastal States Organization (CSO): 34
Coastal Zone Management Act (CZMA): 34
coastline alteration: 218, 224
cobalt, commodities: 89, 90
 demand and technological trends: 90
 domestic production: 90
 foreign sources: 89, 90
 prices: 90
 properties and uses: 89
 stockpile: 89
 substitutes: 89
Cobalt Crust Draft Environmental Impact Statement: 215, 240
cobalt crust mining: 182-183
cobalt crust mining, environmental effects: 240-244
 plume effects: 240-242
 temperature effects: 242
 threatened and endangered species: 243
cobalt crust sampling: 158-160
 and deepsea dredges: 159
 bulk sampling: 160
 measuring crust thickness: 159
 quantitative sampling: 159
 reconnaissance sampling: 159-160
Colombia: 96, 103, 171
commercial potential, marine minerals: 13, 17, 19, 81

- common* depth point seismic data: 264
- consumption, mineral commodities: 82, 83
 - general: 82
 - nickel: 83
 - platinum-group metals: 83
 - titanium: 83
- continental: 3, 7, 41, 42, 45, 47, 49, 50, 52, 57-59
 - drift: 3
 - margins: 41
 - sea: 41, 42
 - shelf: 7, 45, 47, 49, 50, 52, 57, 58, 59
 - slope: 57
- continuous casting, steel: 89
- continuous seafloor sediment sampler: 144, 149, 151
- Convention on the Continental Shelf: 29
- copper, commodities:
 - demand and technological trends: 98
 - domestic production: 98
 - properties and uses: 97
 - resources and reserves: 98
- coring devices: 118, 155-158
 - box core: 156
 - costs: 158
 - impact corers: 155
 - vibracores: 154, 155, 157, 158
- Cross Seamount: 242-243
- dacites: 57
- data classification: 139, 268-277
 - and Navy: 272, 275
 - and NOAA: 272, 275
 - and ocean mining interests: 273
 - costs to scientific and commercial interests: 273
 - foreign policy implications: 275
 - risks to national security: 270-272
- data collection and management: 21, 23, 32, 250-268
 - academic and private laboratories: 267
 - constraints: 251-254
 - Department of the Interior: 263-265
 - industry: 267-268
 - missing components: 252
 - NASA: 265-266
 - Navy: 266-267
 - NOAA: 256-263
 - State and local governments: 267
- Deep Ocean Mining Environmental Study: 215, 236-242
 - and manganese nodule recovery: 236-237
 - objectives: 237
 - recommendations for future research: 240
- deep sea mining environmental impacts: 237-238
- Deep Sea Drilling Project: 137
- Deep Seabed Hard Mineral Resources Act: 29, 237, 305-306
- deep submergence laboratory: 152
- Deep Tow*: 124, 149
- deep water environmental effects: 218, 226, 236-245
- Deepsea Ventures: 159
- Defense Production Act: 92
- deltas: 42, 54, 55
- Department of the Interior: 22, 56, 182
- diorite intrusive: 58
- direct current resistivity: 140-141
- Dominican Republic: 96
- downhole sampling: 162
- drag sampling: 155
- Dredge Material Research Program, Corps of Engineers: 215
- dredge mining technology, air lift suction: 176
- dredge mining technology, bucket ladder-bucket line: 171
 - capacities: 171
 - capital costs: 171
 - limitations: 171
 - operating costs: 171
 - operating depths: 171
- dredge mining technology, bucket wheel suction: 176
- dredge mining technology, cutter head suction dredge: 174-175
 - capabilities: 175
 - capital costs: 175
 - description: 174
- dredge mining technologies, general: 18
- dredge mining technology, grab dredge: 177
- dredge mining technology, hopper dredge: 173-174
 - capabilities: 174
 - capacities: 173
 - capital costs: 174
 - description: 173
- dredge mining technology, new developments and trends: 179-180
 - increasing operating depth: 180
 - motion compensation, stability: 179
- dredge mining technology, suction dredge: 172-173
 - capacities: 172
 - components: 172
 - limitations: 172
 - price and costs: 173
 - types: 172
- dredges, environmental impacts: 233-234
- drill ships: 18
- drilling, percussion: 156-157
 - Amdril: 156-157
 - Becker Hammer Drill: 156-158
 - vibralfit: 157
- E.I. du Pont de Nemours & Co., Inc.: 105, 193
- ECHO I, expedition: 239
- ecological: 20, 21
 - deep-sea communities: 21
 - information: 20
- East-West Center: 73, 74
- electrical techniques: 139-143
 - direct current resistivity: 140-141
 - electromagnetic methods: 140
 - horizontal electric dipole: 140
 - induced polarization: 141-143
 - induced polarization and titanium minerals: 142
 - induced polarization for core analysis: 143
 - MOSES: 140
 - reconnaissance induced polarization: 141
 - self-potential: 141

- spectral induced polarization: 142
- spontaneous polarization: 141
- transient electromagnetic method: 140
- vertical electric dipole: 140
- electromagnetic methods: 140
- endangered species: 243
- Endangered Species Act of 1973: 243
- Energy Security Act of 1980, Title VII: 26
- environmental effects: 20, 110, 215, 218, 222-223, 226-245
 - benthic effects: 215, 223, 226-227, 243, 245
 - deep water effects: 218, 226, 236-245
 - mid-water effects: 215, 222-223, 226
 - plume effects: 222, 226, 234, 239, 240-241
 - shallow water effects: 218, 226, 227-236
 - surface effects: 215, 222, 226
- environmental impact statements: 215, 218, 240, 244
 - Cobalt Crust Draft Environmental Impact Statement: 215
 - Gorda Ridge Draft Environmental Impact Statement: 215, 244
 - Manganese Crust EIS Project: 240
- environmental monitoring: 20, 21, 228-230, 237
- Environmental Studies Program: 219, 264
- Escanaba Trough: 162
- exploration: 8, 22-28, 31
 - budget planning and coordination: 23, 27, 28
 - costs: 25
 - general: 8, 22
 - pre-lease prospecting rules, proposed: 31
 - private sector: 24
 - State programs: 26
- Exclusive Economic Zone (EEZ): 3, 4, 5, 7, 10, 23, 29, 41, 42, 45, 47, 49, 51, 52, 55, 57, 58, 61, 64, 65, 70, 74, 169, 199, 249, 275, 292
- Federal Interagency Arctic Research Policy Committee: 26
- Federal Republic of Germany: 105, 317
 - mining laws: 310-311
- ferromanganese crusts, seabed mining technology: 182
- Finland: 96
- fish, effects of mining on: 231-233, 242, 245
- France: 94, 317
 - mining laws: 309-310
- Frasch process: 183
- Gabon: 94
- Galapagos Rift: 63
- garnet, commodities: 112
- General Instrument Corp.: 256
- geochemical techniques: 143-145
 - dissolved manganese: 143
 - helium-3: 143
 - hydrothermal discharges: 143
 - light scattering measurements: 143
 - methane: 143
 - particulate metals: 143
 - radon-222: 143
 - SLEUTH: 143-144
- temperature: 143
- thermal conductivity: 143
- water sampling: 143-144
- geographic locations, United States:
 - Alabama: 282, 291
 - Alaska: 12, 16, 24, 40, 41, 56, 65, 67, 68, 100, 103, 128, 138, 169, 171, 177, 192
 - Alaska Peninsula: 66, 68
 - Aleutian Islands (AK): 41, 66
 - Ambrose Channel: 231, 290
 - American Samoa: 293, 298
 - Appalachian Mountains: 49, 50
 - Atlantic coast: 45
 - Atlantic Ocean: 43
 - Baker Island: 292
 - Baltimore Canyon: 43
 - Beaufort Sea: 41, 67, 69, 122, 253
 - Bering Sea: 12, 40, 66, 67, 68, 69, 122, 138
 - Blake Plateau: 12, 24, 45, 53, 94
 - Brooks Range (AK): 67
 - California: 12, 41, 42, 56, 57, 58, 60, 65, 122, 138, 281, 282, 291
 - California Borderland: 61
 - Cape Farrello (OR): 60
 - Cape Mendocino (CA): 57
 - Cape Prince of Wales (AK): 67, 69
 - Cascade Mountains: 41, 58
 - Chagvan Bay (AK): 69
 - Chesapeake Bay: 51, 52, 224, 290
 - Chukchi Sea: 67, 69, 122
 - Columbia River: 57, 60, 291
 - Colville River: 67
 - Connecticut: 283, 290
 - Cook Inlet (AK): 67, 68
 - Coquille River (OR): 60
 - Coronado Bank: 61
 - Delaware: 281, 283, 290
 - Delaware River: 52
 - Delmarva Peninsula: 47
 - Dog Island (FL): 56
 - Escanaba Trough: 65
 - Florida: 12, 16, 41, 45, 53, 175, 281, 283, 290, 291
 - Forty Mile Bank: 61
 - Galveston (TX): 55
 - Georges Bank: 45, 46, 52
 - Georgia: 45, 49, 53, 281, 284, 290
 - Goodnews Bay (AK): 12, 68
 - Gorda Ridge: 12, 29, 42, 57, 61, 64, 65, 244-245, 291
 - Grand Isle, (LA): 218, 224
 - Gray's Harbor (WA): 57, 60
 - Guam: 292, 293, 296, 298
 - Gulf of Alaska: 40, 65, 67, 69
 - Gulf of Mexico: 42, 55, 56, 122, 138, 183, 253
 - Hawaii: 43, 69, 95, 122, 182, 284, 290, 291
 - Hawaiian Archipelago: 72, 240, 243
 - Hoh River (WA): 60
 - Howland Island: 292
 - Jacksonville (FL): 53
 - James River (VA): 51
 - Johnston Island: 240, 243, 292

- Kayak Island (AK): 67
Kingman Reef: 292
Klamath Mountains (CA, OR): 58, 59, 60
Kodiak Island (AK): 67, 68
Kuskokwim Mountains (AK): 66, 69
Long Island: 47, 50
Louisiana: 55, 56, 281, 284, 291
Maine: 45, 94, 281, 285
Maryland: 285
Massachusetts: 12, 281, 285, 290
Miami Terrace (FL): 53
Midway Island: 292
Minnesota: 95, 103
Mississippi: 41, 281, 286
Mississippi River: 55, 56
Montana: 103
Monterey Bay (CA): 57
Nantucket Shoals: 45
Necker Ridge (HI): 71
New England: 51
New Hampshire: 281, 286
New Jersey: 12, 41, 47, 286, 290
New York: 12, 41, 287, 290
New York City (NY): 45
North Carolina: 47, 52, 53, 192, 281, 287, 291
Olympic Mountains (WA): 57, 58
Onslow Bay (NC): 52, 53, 192
Oregon: 12, 16, 40, 42, 57, 58, 59, 60, 97, 122, 244, 281, 287, 290, 291
Osceola Basin (FL): 53
Pacific Mountains (HI): 72
Pacific Ocean: 41, 53, 63
Palmyra Atoll: 292
Penguin Bank (HI): 69
Pescadero Point: 61
Point Conception (CA): 56, 57, 58, 60
Portland (OR): 57
Prince of Wales Island (AK): 67
Puerto Rico: 122, 291, 292, 294
Raritan River: 231
Rhode Island: 288, 290
Salmon River (AK): 69
San Andreas Fault (CA): 56
San Diego Bay: 57
San Francisco (CA): 57
Santa Rosa Island (FL): 56
Savannah River: 53
Seattle (WA): 57
Seward Peninsula (AK): 12, 67
Smith Island (VA): 52
South Carolina: 288
S.P. Lee Seamount: 72
St. George Island (FL): 56
Sur Knoll: 61
Texas: 281, 288
Thirty Mile Bank: 61
Trust Territories: 122, 295, 298
Twin Knoll: 61
Tybee Island (GA): 53, 192
Vermont: 49
Virgin Islands: 122, 292, 293, 296, 298
Virginia: 281, 289, 290, 291
Wake Island: 292
Washington: 122, 281, 289, 290
Wisconsin: 100
Yakutat (AK): 67
Yukon River: 66
Geophysical Data System: 268
Ghana: 171
glacial deposition: 46, 47
Global Marine, Inc.: 177
Global Positioning System: 128, 131-132, 137, 268
GLORIA: 116, 119-123, 128, 131, 249, 251, 254-255, 266
gold, commodities: 100, 101
 demand and technological trends: 101
 domestic production: 101
 domestic resources and reserves: 101
 properties and uses: 100
gold placers, seabed mining scenario: 200-203
 at-sea processing: 200
 costs: 203
 environmental effects: 203
 location and description: 199, 203
 mining technology: 200
Gorda Ridge: 122
 Draft Environmental Impact Statement: 215, 244
Gorda Ridge Task Force: 244-245, 291
government subsidies: 23
grab sampling: 118, 154, 155
gravity: 17, 138, 163
 airborne gravimetry: 138
 and navigation: 163
 shipborne gravimeters: 17, 138
Great Lakes Dredge & Dock Co.: 199
Greece: 87
Green Cove Springs Deposit: 105
Guam: 292, 293, 296, 298
Guaymas Basin: 65

Hallsands (UK): 224
Hanna Mining Co.: 97
Harwell Laboratory: 144
Hawaii Institute of Geophysics: 122
Hawaii Undersea Research Laboratory: 244
High Energy Benthic Boundary Layer Experiment (HEBBLE): 218
Hydrochart: 128, 256
hydrothermal activity: 42, 63, 64, 65

igneous rocks: 49
induced polarization: 18, 141-143
Inspiration Resources (Mines): 16, 40
Institute of Oceanographic Sciences: 119, 255
International Council for Exploration of the Sea: 215, 218, 227-228
 recommendations: 228
 zones: 228
International Hydrographic Bureau: 123, 132
international law: 296

- International Submarine Technology, Ltd.: 122
 International Tin Council: 85
- Japan: 39, 41, 65, 105, 173, 174, 177, 317
 mining laws: 311-312
- John Chance Associates: 123
- Johnston Island: 17, 74, 182, 240, 243, 292
- JOIDES Resolution: 160-161
- Juan de Fuca Ridge: 12, 42, 57, 61, 63, 65, 122, 134, 140, 141, 143, 161
- Kane Fracture Zone: 161
- Kingman-Palmyra Islands: 74, 292
- Kerr-McGee Chemical Corp.: 106
- Koken Boring & Machine Co.: 161
- Lamont-Doherty Geological Observatory: 26, 122, 131
- LORAN-C: 163-164
- Louisiana Purchase: 115
- mafic rocks: 57
- magnetic anomalies: 59, 136, 137
- magnetic profiling: 118, 136-138
 airborne surveys: 136
 satellite surveys: 136
 ship-towed magnetometers: 137
 sub-bottom profilers: 133
 total field measurements: 137
- magnetometers: 17, 137
- Magnuson Fishery Conservation and Management Act of 1976: 6
- Malaysia: 171
- manganese, commodities:
 demand and technological trends: 95
 properties and uses: 94
 resources and reserves: 95
- Manganese Crust EIS Project: 240
- Marconi Underwater Systems: 122
- margins, continental: 42
- Marine Ecosystems Analysis Project: 262
- Marine Policy and Ocean Management Center: 273
- materials: 13, 88
 conservation: 13, 88
 recycling: 13, 88
 substitution: 13, 88
- Materials Act of 1947: 305
- metamorphic rocks: 49
- Mexico: 98, 99
- Mid-Atlantic Rift Valley: 160
- mid-water environmental effects: 215, 222-223, 226
 heavy metals: 223, 226
 particulate concentrations: 222, 226
- mineral commodities:
 chromium: 13, 14
 cobalt: 13, 85, 88, 89
 ferrochromium: 14, 15, 86, 87
 ferromanganese: 14, 15, 86, 87, 94
 lead: 13, 88
 manganese: 13, 14, 88
 markets: 8, 17, 81
 nickel: 13, 14, 88
 phosphate rock: 14, 16, 19
 platinum-group metals: 13, 88
 steel: 14, 87
 supply and demand: 8, 81, 87
 tin: 13
 titanium: 13, 88
 titanium pigment: 14
 zinc: 13
- mineral laws, United States: 300-306
 Deep Seabed Hard Mineral Resources Act: 305-306
 Materials Act of 1947: 305
 Mineral Leasing Act for Acquired Land: 305
 Mineral Leasing Act of 1920: 300-305
 Mining Law of 1872: 300-304
 Outer Continental Shelf Lands Act: 305
 Surface Resources Act of 1955: 300-305
- Mineral Leasing Act for Acquired Land: 305
- Mineral Leasing Act of 1920: 300-305
- mineral occurrences, general:
 amber: 39
 amphiboles: 49, 56, 58
 cerium: 71
 chromite: 12, 15, 39, 49, 58, 59, 60
 coal: 39
 cobalt: 53, 71, 75
 copper: 39, 53, 75
 diamonds: 41, 49, 171
 ferromanganese crusts: 10, 12, 16, 39, 53, 70, 71, 72, 73, 90, 96
 ferromanganese nodules: 10, 12, 16, 39, 53, 63, 70, 72, 75, 81, 91
 garnets: 49, 59, 60
 gemstones: 39, 49
 gold: 39, 40, 49, 50, 55, 58, 59, 68, 69, 171
 heavy minerals: 8, 14, 15, 19, 49, 50, 51, 52, 55, 56, 59, 105, 174
 ilmenite: 14, 15, 51, 56, 59
 iron: 39, 312
 lead: 39, 71
 lime: 39
 magnetite: 18, 39, 59, 60
 metalliferous muds: 39, 174
 molybdenum: 71
 monazite: 49, 55, 60, 308
 nickel: 53, 75
 oil and gas: 18, 45
 phosphorite: 10, 14, 15, 52, 53, 56, 61, 69, 308, 316
 placers: 10, 12, 15, 18, 39, 40, 45, 48, 49, 50, 52, 54, 56, 57, 59, 60, 67, 68, 69,
 platinum: 12, 49, 58, 60, 68, 171
 polymetallic sulfides: 8, 10, 16, 19, 39, 45, 61, 62, 63, 65, 98, 100
 precious coral: 39
 precious metals: 12, 39, 49, 50, 58, 59, 67
 pyroxenes: 49, 56, 58
 rhodium: 71
 rutile: 15, 49, 51, 171, 308
 salt: 43, 55
 sand and gravel: 12, 16, 39, 45, 46, 47, 48, 52, 54, 55,

- 57, 67, 69, 174, 308, 309, 310, 311, 312, 313, 315
shells: 39
silver: 65
staurolite: 39
sulfur: 43, 55
tin (cassiterites): 39, 49, 169, 171, 308, 314
titanium: 39, 49, 52, 60, 71
tourmaline: 49
vanadium: 71
zinc: 39, 63, 65, 71
zircon: 39, 49, 56, 59, 60, 308
mineral processing technologies: 20, 186-192
at-sea deployment: 185, 191, 192
at-sea v. onshore: 186
classifiers: 188
electrostatic separation: 190
flotation: 190
general: 20
gravity separation: 188
magnetic separation: 189, 190
shipboard processing: 20
trommel: 188
minerals industry, overcapacity: 8, 13
Minerals Management Service (MMS): 16, 22, 26, 29, 31, 73, 136, 249, 253, 263
minerals, strategic and critical: 9
mining industry, state of: 85
Mining Law of 1872: 300-304
mining laws of other countries: 307-316
Australia: 307-309
Canada: 309
France: 309-310
Federal Republic of Germany: 310-311
Japan: 311-312
Netherlands: 312-313
New Zealand: 315, 318
Norway: 313
Thailand: 313-314
United Kingdom: 314-315
miocene: 56
monazite, commodities: 112
monitoring, environmental: 20, 21, 228-230, 237
Morocco: 16, 85
multi-beam echo sounders: 22, 124-131, 249, 254, 276
National Academy of Sciences: 271
Naval Studies Board: 271
National Acid Precipitation Assessment Program: 26
National Advisory Committee on Oceans and Atmosphere: 271
National Aeronautics and Space Administration (NASA): 26, 265-266
Ames Research Center: 266
data handling problems: 266
NASA Science Internet: 265-266
National Space Science Data Center: 265
National Climatic Data Center: 263
National Defense Stockpile: 10, 87, 89, 92, 94, 96, 98, 99, 101, 102
National Environmental Satellite, Data and Information System: 22
National Geophysical Data Center: 22, 32, 131, 136, 253-256, 259-261, 266, 273
data handling problems: 260, 261
Marine Geology and Geophysics Division: 259, 260
mission: 259
types of data held: 260, 261
National Governors Association (NGA): 34
National Marine Fisheries Service: 239, 257, 259
National Marine Pollution Information System: 262
National Marine Pollution Program: 27
National Materials Advisory Board (NMAB): 93
National Ocean Pollution Planning Act of 1978: 27
National Ocean Service (NOS): 23, 163-164, 254-257, 261, 266
National Oceanic and Atmospheric Administration (NOAA): 6, 17, 22, 25, 122, 128, 131-132, 136, 143-144, 218, 219, 230, 239, 237, 253-263
National Oceanographic Data Center: 22, 32, 253, 256, 261-263, 266
National Operations Security Advisory Committee: 270
National Science Foundation (NSF): 22, 26, 32, 253
Division of Ocean Sciences: 253, 267, 273
Division of Polar Programs: 267
National Seabed Hard Minerals Act of 1987 (H. R. 1260): 29
National Security Council: 271, 275
Naval Ocean Research and Development Activity: 123, 130
Naval Oceanographic Office: 266
navigable waterways, dredging: 229
navigation: 162-164
ARGO: 163-164
circular error of position: 163
data classification: 268
Global Positioning System: 163-164, 268
LORAN-C: 163-164
Mini-Ranger: 163
Precise Positioning Service: 163
Raydist: 163-164
Standard Positioning Service: 164
Netherlands: 297, 317
mining laws: 312-313
neutron activation: 145
New Caledonia: 96
New England Offshore Mining Environmental Study: 215, 227, 229, 230
recommendations: 230
New York Harbor Sea Grant studies: 231
New Zealand: 167, 171, 315, 318
mining laws: 315, 318
nickel, commodities:
demand and technological trends: 97
domestic production: 96
domestic resources and reserves: 96
properties and uses: 96
Nippon Kokan: 182
NORDCO: 161

- North Sea, sand and gravel: 228
- Northern Mariana Islands: 292, 295, 298
- Norway: 89, 318
mining laws: 313
- nuclear exploration techniques: 18, 118, 144-145
continuous seafloor sediment sampler: 144, 149, 151
cookie maker: 144
neutron activation: 145
X-ray fluorescence: 144
- Ocean Assessment Division, NOAA: 263
- Ocean Drilling Program: 137, 160
- Ocean Mining Associates: 239
- oceanic crust: 42, 45
- Office for Research and Mapping in the Exclusive Economic Zone: 252
- Office of Energy and Marine Geology: 254, 255
- Office of Management and Budget (OMB): 26
- Office of Naval Research: 266
- Office of Oceanography and Marine Assessment, NOAA: 257
- Office of Oceans and Atmospheric Research: 257
- Office of Science and Technology Policy: 271
- Office of Strategic and International Minerals, MMS: 263
- offshore mining technologies, transfer of oil and gas technology: 185
- optical imaging: 152-154
ANGUS: 152
Argo: 152-153
data transmission: 152-153
fiber optic cables: 152-153
Jason: 152-153
- Organization of Petroleum Exporting Countries (OPEC): 85
- Outer Continental Shelf: 22, 56, 59
- Outer Continental Shelf Environmental Assessment Program: 262
- Outer Continental Shelf Lands Act: 6, 23, 28, 263, 300, 305
- Pacific Geosciences Center: 140
- Pacific Islands, mineral occurrences: 95
Belau-Palau: 74
Federated States of Micronesia: 74
French Polynesia: 72
Guam: 74
Howland-Baker: 74
Jarvis: 74
Johnston Island: 17, 74, 182
Kingman-Palmyra Islands: 74
Marshall Islands: 72, 74
Samoa: 74
Wake Islands: 74
- Pacific Ocean: 3, 12, 16
- passive margins: 42
- peridotite deposits: 49
- Peru: 98, 99
- Philippines: 87
- phosphate rock:
demand and technological trends: 109
domestic production: 109
domestic resources and reserves: 108
foreign competition: 108
properties and uses: 107
- phosphorite, Onslow Bay (NC), seabed mining scenario: 207-209
costs: 209
location and description: 207
mining technology: 207
processing technology: 207
profitability: 209
- phosphorite, Tybee Island (GA), seabed mining scenario: 204-206
at-sea processing: 206
costs: 206
location and description: 204
mining technology: 205
processing technology: 205
profitability: 206
- pigments: 91, 93, 96, 104, 107
chromium: 91, 93
nickel: 96
titanium: 104, 107
- plate tectonics: 3, 43, 61, 69
- platinum-group metals, commodities: 102-103
demand and technological trends: 103
domestic production: 103
domestic resources and reserves: 102
foreign sources: 102
properties and uses: 102
- Pleistocene: 45, 46, 57, 65, 67
- plume environmental effects: 222, 226, 234, 239, 240, 241
- polymetallic sulfides, seabed mining technology: 160-162, 181-182
concepts: 181
conditions: 181
problems: 182
sampling: 160-162
- positioning: 162-164
- Preussag AG: 182
- prices, commodity: 83, 85
general: 83
nonmetallic: 85
speculation: 85
- Puerto Rico: 122, 291, 292, 294, 298
- Pungo River Formation: 52
- radiometric dating: 71
- Raritan River: 231
- Reagan Proclamation (No. 5030): 5, 6, 275
- reconnaissance surveys: 17, 18, 56
- reconnaissance technologies: 119-139
- refractories: 93
- remotely operated vehicle (ROV):
advantages and limitations: 146-148
and hard mineral exploration: 151
and navigation: 163
ANGUS: 151
Argo: 152
capabilities: 149-151

- comparison with manned submersibles: 146-148
- costs: 148-149
- Deep Tow*: 149
- instrumentation: 146
- Jason Junior*: 151
- needed technical developments: 151-152
- Solo: 149
- towed vehicles: 149-150
- types: 146
- Republic of South Africa: 41, 85, 87, 91, 94, 102, 175
- rift zone: 43, 63
- S.P. Lee: 116-117, 245
- sampling technologies: 12, 154-162
 - characteristics of: 154-155
 - crust sampling: 158-160
 - placer sampling: 154-158
 - polymetallic sulfide sampling: 160-162
 - representative sampling: 154-155
- sand and gravel (see mineral occurrences, general):
 - demand and technological trends: 111
 - domestic production: 111
 - domestic resources and reserves: 111
 - seabed mining ventures: 199
- Sandy Hook Marine Laboratory: 231
- satellites: 22
- schist: 57
- Scotian Shelf: 45
- Scripps Institution of Oceanography: 26, 131, 132, 140, 263
- Sea Beam: 122, 123, 126-128, 131, 268, 276
- Sea Cliff: 245
- Sea Grant: 215, 227, 229, 231, 257
 - data collection: 257
 - New York studies: 215, 227, 229, 231
- seabed mining:
 - competitiveness: 15, 16, 17, 19, 167
 - economic potential: 8, 17
 - legislation: 23, 28, 30, 31
 - technology: 10, 15, 17, 181, 182
 - world: 39
- SeaMARC systems: 122-124, 128, 132
- seamounts: 42, 72, 74
- seasonal environmental effects: 224, 226
- sedimentary rocks: 45, 57, 58, 67
- seismic reflection: 17, 22, 118, 132-136
 - chirp signals
 - profiles: 47, 56
 - sub-bottom profilers: 133
 - three-dimensional seismic surveying: 135
- seismic refraction: 118, 132-136
- self-potential: 141
- shallow water environmental effects: 218, 226, 227-236
 - dredges and: 233-234
 - ICES: 228
 - minimizing effects: 232-233
- Shell Oil Co.: 200
- ships, National Oceanic and Atmospheric Administration: 131
 - Surveyor*: 131, 268, 270
- Discoverer*: 131
- Davidson: 131, 271
- side-looking sonars: 17, 116, 119-124
 - Deep Tow*: 124, 149
 - GLORIA atlas: 122
 - GLORIA: 116, 119-123, 128, 131
 - Interferometric systems: 123
 - long-range side-looking sonar: 116, 119-122
 - mid-range side-looking sonar: 118-119
 - Mini-Image Processing System: 119
 - SeaMARC systems: 122-124, 128, 132
 - short-range side-looking sonar: 118-119, 124
 - Systeme Acoustique Remorque: 124
- Sierra Leone: 104, 171
- silt curtain: 235-236
- site-specific technologies: 139-162
- SLEUTH: 143-144
- solution/borehole mining technology: 183
- Sound Ocean Systems: 162
- Southwest Africa: 169
- sphalerite: 63
- spontaneous polarization: 141
- spreading centers, seafloor: 3, 41, 63, 64
- State-Federal Task Forces: 34, 291
- State-owned or State-controlled minerals companies: 14, 86
- State resource management: 281
- strategic and critical minerals: 9, 88, 94, 96, 98, 101, 102
- Strategic Assessment Branch, NOAA: 218, 219, 257
 - atlases: 221, 257
- Strategic Petroleum Reserve/Brine Disposal Program: 262
- Stillwater Complex: 92, 103
- Stillwater Mining Co.: 103
- subduction zone: 3, 41, 57
- Submerged Lands Act of 1953: 4
- submersibles, manned: 18, 145-152
 - advantages and limitations: 146-148
 - Alvin*: 145, 148, 151, 152, 161
 - and hard mineral exploration: 151
 - battery-powered: 145
 - capabilities: 149-151
 - comparison with remotely operated vehicles: 146-148
 - costs: 148-149
 - free-swimming: 145
 - Johnson-Sea-Link: 148
 - needed technical developments: 151-152
- superalloys: 88, 91, 96
- surface environmental effects: 215, 222, 226
- Surface Resources Act of 1955: 300
- tectonic processes: 41
- territorial sea: 4
- Territories, United States: 55, 292-299
- tertiary sediments: 57, 58
- Texas A&M University: 123
- Thailand: 169, 171, 318
 - mining laws: 313-314
- Third World: 13
- Titanic: 124, 151, 152, 154

- titanium, commodities: 104-106
 demand and technological trends: 106
 domestic production: 105
 domestic resources and reserves: 104
 foreign sources: 104
 properties and uses: 104
- titanium heavy mineral sands, seabed mining scenario:
 193-196
 at-sea processing: 193
 costs: 196
 location and description: 193
 mining technology: 193
 operation: 194
- Trail Ridge Formation: 52
- Tropical Ocean Global Atmosphere Study: 263
- Truman Proclamation (No 2667): 6
- Turkey: 87, 91
- ultramafic rocks: 49, 57, 58, 60
- Union of Soviet Socialist Republics (U.S.S.R.): 91, 98,
 102, 105, 109
- United Kingdom (U.K.): 102, 119, 169, 173, 218, 224,
 297, 314, 318
 mining laws: 314-315
- U.N. Conference on the Law of the Sea: 3, 7, 29, 64, 70,
 76, 275
- U.S. Army Corps of Engineers (COE): 12, 20, 26, 47,
 224, 227, 231, 233, 240
 dredging of navigable waterways: 229
- U.S. Bureau of Mines (BOM): 22, 26, 59, 160, 192, 249,
 265
- U.S. Coast Guard (USCG): 249
- U.S. Department of Defense (DOD): 253, 276
- U.S. Department of Energy (DOE): 26, 249, 262
- U.S. Department of the Interior (DOI): 263
- U.S. Environmental Protection Agency (EPA): 26, 229,
 232, 249
- U.S. Geological Survey (USGS): 17, 22, 25, 51, 71, 119,
 141, 122, 131, 142, 143, 159, 249, 253-254, 265
- U.S. Navy: 23, 32, 118, 128, 131, 249
 data collection: 266-267
 data classification: 270-272, 275-277
- U.S. Treasury: 101
- University National Oceanographic Laboratory System:
 132
- vibracores: 143
- Virgin Islands: 122, 292, 293, 296, 298
- Wake Island: 292
- water column environmental effects: 222-223, 226
- wave pattern alteration: 218, 224
- Williamson & Associates: 162
- Woods Hole Oceanographic Institution: 26, 131, 152,
 161, 273
- wurtzite: 63
- X-ray fluorescence: 144
- Yugoslavia: 91
- Zaire: 85, 89, 98
- Zambia: 89, 98
- Zellers-Williams, Inc.: 205
- Zimbabwe: 87, 91
- zinc, commodities: 99, 100
 demand and technological trends: 100
 domestic production: 100
 domestic resources and reserves: 100
 properties and uses: 99
- zircon, commodities: 112