

FLIGHT SAFETY REVIEW PROCESS FOR SPACE NUCLEAR POWER SOURCES

GARY L. BENNETT
OFFICE OF SPECIAL APPLICATIONS
U.S. DEPARTMENT OF ENERGY



IECEC '87

22nd Intersociety Energy Conversion Engineering Conference
"ENERGY-NEW FRONTIERS"

Wyndham Franklin Plaza
Philadelphia, Pennsylvania
August 10-14, 1987

This page intentionally left blank.

FLIGHT SAFETY REVIEW PROCESS FOR
SPACE NUCLEAR POWER SOURCES

Gary L. Bennett
Division of Special Applications
U.S. Department of Energy
Washington, D.C. 20545

Abstract

This paper describes the general flight safety review process used in the United States for space nuclear power sources. This process and its goals are generally consistent with recommendations of the United Nations Working Group on the Use of Nuclear Power Sources in Outer Space. As a recent illustrative example, specific attention will be focused on the flight safety review process as it was applied to the radioisotope thermoelectric generators (RTGs) planned to be used on the Galileo and Ulysses spacecraft.

Background

Since 1961, the United States has successfully used 34 RTGs and 1 reactor in 20 satellites and space systems launched by the National Aeronautics and Space Administration (NASA) and the Department of Defense (DoD) (1*). Table 1 summarizes the space nuclear power systems launched by the United States to date. The record of these systems has shown that they can be safely and reliably built and employed to meet a variety of space mission objectives.

Table 1. Summary of Space Nuclear Power Systems Launched by the United States

POWER SOURCE ¹	SPACECRAFT	MISSION TYPE	LAUNCH DATE	STATUS
SNAP-3B7	TRANSIT 4A	NAVIGATIONAL	20 JUNE 1961	SUCCESSFULLY ACHIEVED ORBIT
SNAP-3B8	TRANSIT 4B	NAVIGATIONAL	16 NOV. 1961	SUCCESSFULLY ACHIEVED ORBIT
SNAP-9A	TRANSIT 5BN-1	NAVIGATIONAL	28 SEPT. 1963	SUCCESSFULLY ACHIEVED ORBIT
SNAP-9A	TRANSIT 5BN-2	NAVIGATIONAL	5 DEC. 1963	SUCCESSFULLY ACHIEVED ORBIT
SNAP-9A	TRANSIT 5BN-3	NAVIGATIONAL	21 APRIL 1964	MISSION ABORTED; BURST UP ON REENTRY
SNAP-10A REACTOR	SNAPSHOT	EXPERIMENTAL	3 APRIL 1965	SUCCESSFULLY ACHIEVED ORBIT
SNAP-10B2	MINIBUS-S-1	METEOROLOGICAL	18 MAY 1965	MISSION ABORTED; HEAT SOURCE RETRIEVED
SNAP-10B3	MINIBUS II	METEOROLOGICAL	14 APRIL 1968	SUCCESSFULLY ACHIEVED ORBIT
SNAP-27	APOLLO 13	LUNAR	14 NOV. 1968	SUCCESSFULLY PLACED ON LUNAR SURFACE
SNAP-27	APOLLO 13	LUNAR	11 APRIL 1970	MISSION ABORTED ON WAY TO MOON; HEAT SOURCE RETURNED TO SOUTH PACIFIC OCEAN
SNAP-27	APOLLO 14	LUNAR	31 JAN. 1971	SUCCESSFULLY PLACED ON LUNAR SURFACE
SNAP-27	APOLLO 16	LUNAR	20 JULY 1971	SUCCESSFULLY PLACED ON LUNAR SURFACE
SNAP-19	PIONEER 10	PLANETARY	2 MAR. 1972	SUCCESSFULLY OPERATED TO JUPITER AND BEYOND
SNAP-27	APOLLO 16	LUNAR	16 APRIL 1972	SUCCESSFULLY PLACED ON LUNAR SURFACE
TRANSIT-RTG	"TRANSIT" (TRANSIT-110)	NAVIGATIONAL	2 SEPT. 1972	SUCCESSFULLY ACHIEVED ORBIT
SNAP-27	APOLLO 17	LUNAR	7 DEC. 1972	SUCCESSFULLY PLACED ON LUNAR SURFACE
SNAP-19	PIONEER 11	PLANETARY	8 APRIL 1973	SUCCESSFULLY OPERATED TO JUPITER AND SATURN AND BEYOND
SNAP-19	VIKING 1	MARS	20 AUG. 1976	SUCCESSFULLY LANDED ON MARS
SNAP-19	VIKING 2	MARS	9 SEPT. 1976	SUCCESSFULLY LANDED ON MARS
SNW-RTG	LES 8	COMMUNICATIONS	14 MAR. 1976	SUCCESSFULLY ACHIEVED ORBIT
SNW-RTG	LES 9	COMMUNICATIONS	14 MAR. 1976	SUCCESSFULLY ACHIEVED ORBIT
SNW-RTG	VOYAGER 2	PLANETARY	20 AUG. 1977	SUCCESSFULLY OPERATED TO JUPITER, SATURN, URANUS, AND BEYOND
SNW-RTG	VOYAGER 1	PLANETARY	8 SEPT. 1977	SUCCESSFULLY OPERATED TO JUPITER AND SATURN AND BEYOND

¹ SNAP STANDS FOR SYSTEMS FOR NUCLEAR AUXILIARY POWER. ALL ORB-NUMBERED SNAP POWER PLANTS USE RADIOISOTOPES FULL IVES. NUMBERED SNAP POWER PLANTS HAVE NUCLEAR REBORN REACTORS AS A SOURCE OF HEAT. SNW-RTG STANDS FOR THE MULTITHYRISTOR BATTERY RADIOISOTOPES THERMOELECTRIC GENERATOR.

Each of the U.S. space nuclear power systems flown was extensively reviewed from a safety perspective by the involved agencies prior to launch. The U.S. Department of Energy (or its predecessor agencies) provides the nuclear power sources (NPS) and is responsible for the safety testing and analyses associated with their planned use. For the first two U.S. NPS flown (SNAP-3B7 and SNAP-3B8 flown on DoD navigation satellites in 1961) the Atomic Energy Commission (AEC) (a predecessor agency to DOE) and DoD conducted a safety review according to their internal regulations. As was customary on AEC terrestrial nuclear facilities, the AEC's contractor prepared a safety analysis

report that assessed the response of the SNAP-3B RTG to postulated launch accidents. Approval to launch involved coordination with the Department of State and the White House (2).

In preparation for the SNAP-9A launches aboard the Transit 5BN navigational satellites beginning in 1963, an expanded safety review group was established and more detailed review procedures were developed and implemented. Because of its expertise in launch vehicles, NASA was invited to participate and the reviews were coordinated through the joint AEC/NASA Space Nuclear Propulsion Office. The impetus to develop efficient and comprehensive safety review and launch approval procedures was reinforced by the SNAP-10A reactor launch in 1965 (2).

In reviewing the evolution of the space nuclear safety review process, T. B. Kerr, then the NASA coordinator for interagency nuclear safety reviews observed that "Since the specialists were inexperienced in working with the space-related nuclear environments, it was critical to recognize and allow for possible launch failures. It was also obvious that the same procedures used for ground-based systems could not be followed, because the systems were lightweight and could not be enclosed in big protective containers or heavy shielding and because potential launch failures on or near the pad and reentry following an unsuccessful launch and short orbital lifetimes could result in the system falling to earth in unknown and uncontrolled areas. Further, approval at the highest level was required. It was critical for the Department of State and the President and his staff to understand the potential risks of these launches. The potential for political repercussions was great in case of failure because of impact and possible fuel release on foreign territories" (2).

In concert with presidential directives and policy guidance from the former National Aeronautics and Space Council, studies were undertaken to develop a consistent and efficient safety review and launch approval process for space nuclear power sources. Position papers were developed and meetings were held at high levels in the three agencies involved (NASA, DoD, and AEC) that led to the formation of a formal interagency safety review group for each mission. This ad hoc group is now known as the Interagency Nuclear Safety Review Panel or INSRP (2).

Interagency Nuclear Safety Review Panel

Working under Presidential Directive NSC/25 and the various agency guidelines, the INSRP conducts an independent safety review of each proposed nuclear-powered space mission prior to launch. INSRP does not make a recommendation of

launch approval or disapproval; rather, it provides the necessary independent risk evaluation that will be used by decisionmakers who must weigh the benefits of the mission against the potential risks.

An INSRP is generally formed when a user agency (NASA or DoD) has an approved mission and requests participation by the other two agencies in conducting an interagency safety review. INSRP is chaired by three coordinators appointed by the Secretary of DoD, the Administrator of NASA, and the Secretary of DOE. The coordinators then meet to establish operating plans and support requirements and to establish subpanels of experts for certain specialized areas. Under the Presidential Directive, the Nuclear Regulatory Commission (NRC) is invited to send representatives to INSRP meetings although NRC is not part of the official review and approval process (2,3). Historically, the Environmental Protection Agency (EPA) and the National Oceanic and Atmospheric Administration (NOAA) have participated as observers in these reviews. Fig. 1 shows the structure of INSRP as it was established for the Galileo mission and the Ulysses mission, the two currently committed U.S. space-nuclear-powered missions.

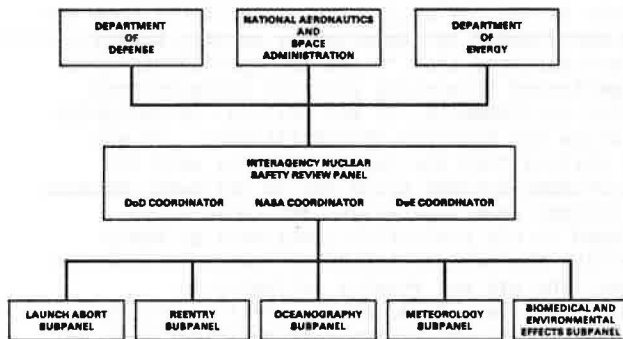

Figure 1. Structure of the Interagency Nuclear Safety Review Panel (INSRP)

As noted in the previous section, DOE is involved in INSRP because it has responsibility for the safety of the NPS that it designs and produces for use in outer space. The program office that manages the design, development, and production of the NPS is generally located in DOE. Under the DOE principle of line management responsibility for safety, the program office prepares and issues safety analysis reports (SARs) which INSRP reviews.

By statute and DOE orders, DOE also has an independent environmental, safety and health organization that conducts independent safety reviews of all of DOE's operations and programs (both nuclear and nonnuclear). Thus, even if INSRP did not exist, a formal review of the NPS would still be undertaken. The DOE INSRP coordinator comes from this independent DOE office, which reports to the Secretary of DOE.

DoD and NASA personnel are involved in INSRP because these two agencies have safety responsibilities and expertise both as launching organizations and as users of NPS on spacecraft. The DoD coordinator comes from the U.S. Air Force (USAF) Inspection and Safety Center (AFISC), which is part of the independent office of the inspector

general of USAF. The NASA coordinator comes from the current safety office at NASA Headquarters. The head of this office reports directly to the Administrator of NASA.

The INSRP approach has the following advantages:

1. A unified nuclear risk assessment is prepared and provided for the launch approval process of the three agencies and higher approval authorities. In the early missions, it was possible for each agency to conduct its own review with the potential for three uncoordinated safety evaluation reports. INSRP provides a mechanism to coordinate the independent reviews that the agencies are required to undertake.
2. Expertise common to a specific participating agency can be made available to the other agencies, thereby eliminating possible duplication of effort.
3. At least one coordinator will not be involved in agency sponsorship of the mission nor will the representatives from NRC, EPA, and NOAA; therefore, their participation ensures an objective view and enhances the independence of the review.
4. It produces an environment conducive to free, open, and timely flow of information.

Once a mission is identified for launch and space use with an NPS (typically several years prior to the intended launch date), an INSRP is formed and it is active almost continuously during the evolution of the mission. Members of the panel and its supporting subpanels are involved during critical program review meetings, in test program reviews, in working group meetings, and any time they believe they can obtain significant information that will help them understand and evaluate the NPS for the proposed mission (2). Early meetings of the coordinators and program managers are useful in establishing requirements and modes of operation. As T. B. Kerr has noted, "Many of the unknowns can be discussed and the tendency to consider each other the opposition can, to a large extent, be eliminated. The INSRP is not interested in preventing a launch; it is interested in evaluating the potential for mishaps and avoiding or minimizing injury or death of people"(2).

Space Nuclear Safety Review Process

The safety review process begins with the submission of a Safety Analysis Report (SAR) by the DOE NPS program office. Fig. 2 shows the generic logic diagram for the space nuclear safety review and launch approval process. The INSRP review is a three-stage process with in most instances at least three formal INSRP reviews: one for the Preliminary Safety Analysis Report (PSAR), one for the Updated Safety Analysis Report (USAR), and one for the Final Safety Analysis Report (FSAR).

In addition to reviewing the DOE-supplied SARs, INSRP reviews information concerning the launch vehicle and launch site provided by the launching agency. Tests and analyses, some sponsored by DOE or the launching agency, will be

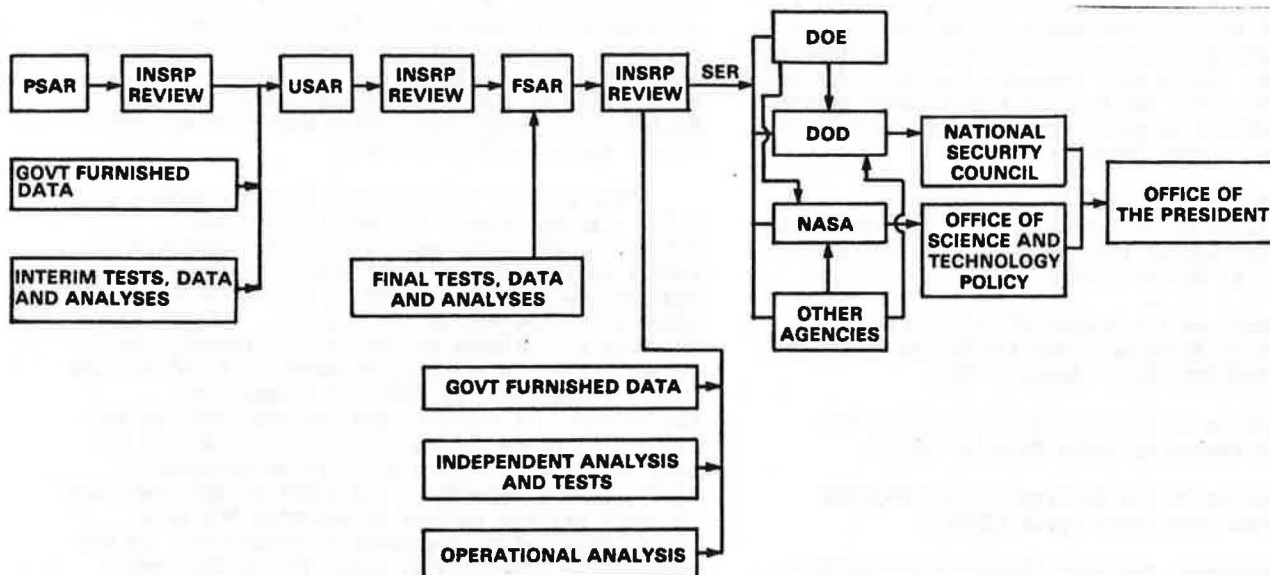

NOTE: FOR EXISTING NUCLEAR SYSTEMS, THE PSAR MAY NOT BE NEEDED.

PSAR = PRELIMINARY SAFETY ANALYSIS REPORT

USAR = UPDATED SAFETY ANALYSIS REPORT

FSAR = FINAL SAFETY ANALYSIS REPORT

SER = SAFETY EVALUATION REPORT

INSRP = INTERAGENCY NUCLEAR SAFETY REVIEW PANEL

Figure 2. Flight Safety Review and Launch Approval Process for Space Nuclear Power Systems

considered and used as needed. The INSRP subpanels can bring to bear special expertise on selected topics. As Mr. Kerr has noted, "Although the subpanels do not develop the data, they analyze them, perform calculations and tests as needed, recommend areas for further analyses of tests, and provide experience and assistance to help program personnel understand the safety needs and avoid unnecessary costs whenever possible" (2).

The logic of having three separate and sequential SARs at key phases of a program is that INSRP has a chance to develop an understanding of the NPS and its proposed use and to provide input on the kinds of information they would like to see in the next SAR.

After the FSAR has been reviewed, INSRP prepares a Safety Evaluation Report (SER) that provides their independent assessment of the risks. The SER is submitted to the heads of the three agencies for their use in the launch approval request process. When the two supporting agency heads are satisfied they submit letters of concurrence to the user agency. The user agency will then submit a letter and a copy of the SER to the Office of Science and Technology Policy (OSTP), within the Office of the President, requesting launch approval. The director of OSTP is empowered to approve the launch; however, consultation and deferral to the President for launch approval can also occur. Recommendation for flight approval constitutes the affirmative judgment of the U.S. Government based on an overall risk-benefit evaluation (2,3).

Safety Objective

Historically the United States has followed the practice of employing stringent design and operational flight safety measures to protect the

public and the environment under normal and postulated accident conditions. The primary safety design objective is to minimize the potential interaction of the radioactive materials with Earth's population and environment. In the case of RTGs, this objective leads to a design philosophy of containment, immobilization, and recovery of the nuclear materials. For reactors, this objective leads to the requirement of not operating the reactor prior to achieving its planned operating orbit and ensuring a subcritical configuration under all credible accident environments so that no fission products are generated (3,4).

The use of NPS in outer space has been a subject under consideration by the U.N. Committee on the Peaceful Uses of Outer Space (COPUOS) since 1978 when the Soviet reactor-powered satellite Cosmos 954 reentered the Earth's atmosphere from low Earth orbit over Canada. Within the framework of the Scientific and Technical Subcommittee (STSC) of COPUOS a Working Group on the Use of Nuclear Power Sources in Outer Space (WGNPS) was established in accordance with U.N. General Assembly resolution 33/16 of 10 November 1978 to consider the technical aspects and safety measures relating to the use of NPS in outer space. The WGNPS held three meetings beginning in 1979 and issued a report in 1981 that still represents the best consensus reached on the subject. The U.S. was an active member of this Working Group and submitted several working papers for consideration by the WGNPS.

It is important to note that COPUOS, its subcommittees and its working groups operate on a consensus basis, which means there can be no disagreement with the text of the reports. Furthermore, it is important to note that these reports are not binding documents in the sense of a treaty. The Legal Subcommittee (LSC) of COPUOS is

working to elaborate draft principles relevant to the use of NPS in outer space but at present there is no treaty or resolution specifically written on this topic. There are, however, four U.N.-derived treaties to which the U.S. is a party that govern U.S. activities in outer space whether nuclear or nonnuclear. These treaties are

1. The Treaty on Principles Governing the Activities of States in the Exploration and Use of Outer Space, Including the Moon and Other Celestial Bodies (1967).
2. Agreement on the Rescue of Astronauts, the Return of Astronauts and the Return of Objects Launched into Outer Space (1968).
3. Convention on International Liability for Damage Caused by Space Objects (1973).
4. Convention on the Registration of Objects Launched into Outer Space (1976).

In addition, two post-Chernobyl conventions also cover the use of NPS in space: Convention on Early Notification of a Nuclear Accident and Convention on Assistance in the Case of a Nuclear Accident or Radiological Emergency. It is interesting to observe that before the Chernobyl accident the LSC was working on draft principles covering the same topics as these two conventions.

Except for some small additional items developed following the reentry of Cosmos 1402 in 1983, the definitive technical text remains that of the 1981 WGNPS report. Thus, it is instructive to consider what the WGNPS had to say. Two introductory paragraphs of the 1981 report are important in understanding the approach of these technical experts:

"The Working Group noted that various types of power sources exist for use on spacecraft such as solar cells, fuel cells and chemical batteries, as well as nuclear systems. Selection of a suitable power source is a complex technical issue and in practice most space missions have used conventional power sources. The particular advantages of the use of NPS are their long life, compactness and ability to operate independently of solar radiation.

"For certain important space missions, NPS have been the preferred technical choice. Provided the additional risks associated with NPS are maintained at an acceptably low level, the Working Group considered that the basis of the decision to use NPS should be technical" (5). (Emphasis added.)

The WGNPS stated that "the risks inherent in each particular application or project are to be assessed in terms both of the probability of failure or malfunction and the severity of its consequences" (5). The WGNPS then identified the following safety criteria for RTGs and nuclear reactors:

"It was noted that the safety of radioisotope systems was being assured by designing them to contain with a high probability of success the radioisotope for normal and credible abnormal conditions. The design should ensure minimal leakage of the radioactive contents with a

reasonably high level of probability of success in all credible circumstances including launch accidents, reentry into the atmosphere, impact and water immersion. The appropriate limits recommended by the International Commission on Radiological Protection (ICRP) should be met for normal operational conditions.

"The Working Group agreed that the safety of U-235 reactor systems did not present any difficulty when they were started and operated in orbits sufficiently high to give time for radioactive materials to decay to a safe level in space after the end of the mission. In this way the dose equivalents at the time of reentry could be guaranteed in all circumstances to be within the limits recommended by ICRP for nonaccident conditions. If reactors are intended for use in low orbits where the radioactive materials do not have sufficient time to decay to an acceptable level, safety depends on the start of the operation in orbit and the success of boosting NPS to a higher orbit after operation is completed. In the event of an unsuccessful boost into higher orbit the system should in all credible circumstances be capable of dispersing the radioactive material so that when the material reaches the earth the radiological situation conforms to the recommendations of ICRP when relevant. The Working Group noted that ICRP publication 26 does not provide specific guidance for accidents and emergencies although it does address in general terms the circumstances in which remedial action might be taken" (5).

Since the term "credible" has been used in the WGNPS report, some delegations distinguished two classes of NPS reentry (5):

- o Probable scenarios--those with a probability of occurrence of more than 10^{-3} per individual mission.
- o Improbable scenarios--comprising all the more remote failure probabilities, where the ICRP approach is not directly applicable, and including many highly unlikely events where the dose limits recommended by ICRP may be exceeded, or even greatly exceeded.

Ref. 6 notes that the various safety criteria, objectives and considerations can be met in two major ways: the first by system design, the second by mission design. An example of system design on a nuclear reactor would be the use of mechanical and electrical interlocks to prevent inadvertent premature reactor startup so that there would be little likelihood of generating fission products or of accidental radiation exposure during ground operations or early mission phases.

Ref. 6 also notes that the risks associated with reentry of a reactor can be greatly reduced by applying one or more of the following safety methods: confinement and containment; delay and decay; dilution and dispersion. Ref. 6 goes on to state: "The first of these, effectively the use of barriers to isolate the radioactive material from people and the environment (system design), has the advantage of localizing the radiological risk, but it could, in the case of a 'hot' reactor, lead to acute irradiation of any individual who unwittingly came too close to the reactor or its debris.

However, there is little risk if reentry is in a remote area (mission design)." This last statement provides an important modification to the WGNPS approach while still meeting the overall WGNPS criteria. The Canadian delegation to the 1987 meeting of the STSC apparently recognized this when they submitted a working paper with these criteria (11):

"Nuclear reactors shall be designed either to reenter the Earth's atmosphere and land while maintaining the functional integrity of the containment of radioactive materials, or to divide and disperse into fine particles the radioactive materials upon reentry into the Earth's atmosphere . . ."

Again, from Ref. 6, "delay and decay, i.e., reducing the radioactive level by providing sufficient isolation time, is accomplished through mission design -- either by using 'long life' orbits (as in SNAP-10A) or by boosting the reactor out of a low Earth orbit, the practice generally followed by the USSR." Fig. 3 shows the nuclide activity of a particular reactor, from which it can be seen that maintaining the reactor in orbit for several hundred years results in a very significant reduction in the on board radioactive inventory generated during operations in space, while extension beyond that does not bring any apparent advantage (6).

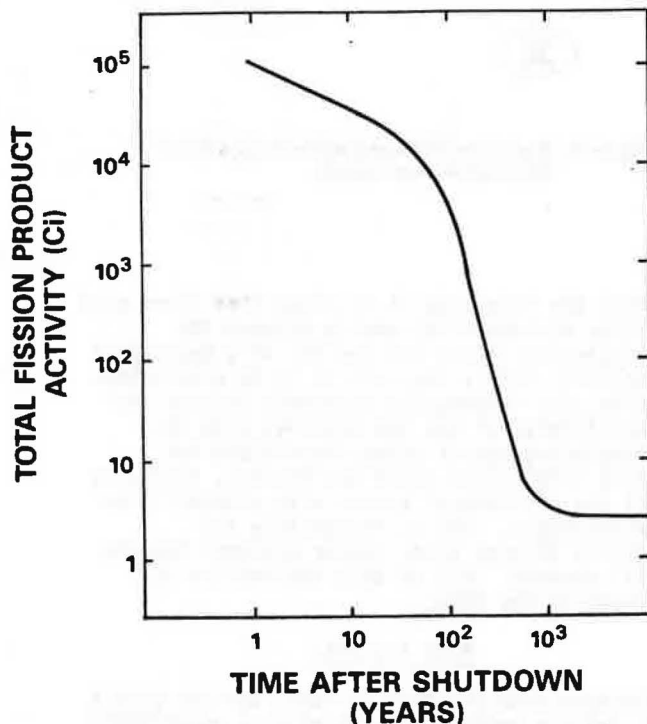

Figure 3. Calculated Radionuclide Activity after Shutdown for a Hypothetical Space Nuclear Reactor which has Operated at 1,000 kWth for 10 Years with a Fuel Mixture of 90% ²³⁵U and 10% ²³⁸U

Finally, from Ref. 6: "The third method, dilution and dispersion, is mostly an aspect of system design and can be achieved in a number of ways -- for example, the use of explosive charges, chemical reagents and materials that will melt during aerodynamic heating."

In the case of RTGs, the design objective is to survive reentry intact following credible exoatmospheric accidents.

It should be emphasized that the WGNPS was well aware from various studies that there are no accepted radiation limits for nuclear accidents and that the limits that apply to normal operation are not applicable to accident situations. In this regard, the "Working Group took particular note of the concept contained in paragraph 220 (of ICRP publication 26) that the restriction of the exposure depends on 'appropriate arrangements for reducing the probability of accidents giving rise to the releases of radioactive materials into the environment and for limiting the magnitude of these releases, should they occur'" (5).

With respect to the international aspects of approval, it should be noted that in its 1981 report, the WGNPS concluded that "the Working Group reaffirmed its previous conclusion that nuclear power sources can be used safely in outer space, provided that all necessary safety requirements are met" (5). This is also a succinct statement of the U.S. position.

Safety Analysis Reports

Table 2 lists the generic types of safety-related documents required for launch and space use of an NPS. While the focus of this paper is on the flight SARs it is important to note that there are DOE (and other agency) orders governing safety, security, and safeguards in the fabrication, assembly, testing, handling, and transportation of the NPS prior to launch. An environmental impact statement or environmental assessment, as appropriate, typically is prepared by the user at the time of the initial decision to undertake the mission. (This is required even if the mission does not involve an NPS.) There is also a requirement as set forth in the Federal Radiological Emergency Response Plan and further codified in the various agency orders and plans for emergency planning in preparation for the launch of an NPS (7).

Table 2. Minimum Safety Documentation Requirements

- **SAFETY ASSESSMENT REPORT**
DEFINES SAFETY ASPECTS OF DESIGN AND MISSION
- **SAFETY PROGRAM PLAN**
OUTLINES TOTAL SAFETY PROGRAM TO ACHIEVE SAFETY OBJECTIVES
- **RADIOLOGICAL PROTECTION PLAN**
PRESENTS RADIOLOGICAL PROTECTION AND HEALTH PHYSICS PROGRAM TO PROTECT PEOPLE
- **GROUND SAFETY ANALYSIS REPORT (GSAR)**
ASSESSES SAFETY OF SITE SPECIFIC OPERATIONS, FACILITIES, PERSONNEL, TRAINING AND EQUIPMENT
- **CRITICALITY ASSESSMENT REPORT**
ASSESSES CRITICALITY ASPECTS OF RTG/HEAT SOURCE, MULTIPLE STORAGE/TRANSPORTATION CONFIGURATIONS
- **SAFETY ANALYSIS REPORTS (FLIGHT)**
PROVIDES OVERALL NUCLEAR RISK ANALYSIS OF THE MISSION
- **SAFETY ANALYSIS REPORT FOR PACKAGING (SARP)**
QUALIFIES THE SHIPPING CONTAINER FOR ISSUANCE OF "CERTIFICATE OF COMPLIANCE" FOR TRANSPORTATION
- **EMERGENCY PREPAREDNESS AND RESPONSE PLAN**
PROTECTION OF PEOPLE IN ACCIDENT SITUATIONS

The analysis of the potential radiological risk of a given mission is documented in the SARs. These safety analyses begin at the initiation of the design concept and continue through the safety evaluation and launch approval process. For new concepts, it is often advisable to prepare an initial safety assessment report prior to the completion of the conceptual design in order to focus design activities on specific mission scenarios that may impact safety.

As noted earlier, three SARs are usually issued. The PSAR is issued soon after a design concept is selected for a given mission. The PSAR includes a description of the NPS and the mission as well as probabilistic radiological risk assessments as supported by the available conceptual design data base. The second report, the USAR, is issued as soon as practical after the power system design freeze. The USAR includes updated information on the mission, the failure modes analysis, and the radiological risk assessment plus any safety tests and data required. The third report, the FSAR, is normally issued about one year before the scheduled launch. The FSAR provides a description of the final design of the system, the mission, and radiological safety assessment data including the results of the safety tests (3).

The PSAR usually consists of two volumes: a Reference Design Document and an Accident Model Document. The USAR (if sufficient information is available) and the FSAR include these two plus a third volume called the Nuclear Risk Analysis Document. Table 3 shows an outline of the contents of these three documents (3).

Table 3. Overall Outline of the Safety Analysis Reports (SARs)

- **REFERENCE DESIGN DOCUMENT**
 - MISSION/FLIGHT SYSTEM SUMMARY
 - NUCLEAR POWER SOURCE DESCRIPTION
 - SPACECRAFT/LAUNCH VEHICLE/TRAJECTORY DESCRIPTION
 - LAUNCH SITE/RANGE SAFETY/RADIOLOGICAL SAFETY DATA
- **ACCIDENT MODEL DOCUMENT**
 - MODELS/DATA
 - EVENT TREE ANALYSES
 - NUCLEAR POWER SOURCE RESPONSE
- **NUCLEAR RISK ANALYSIS DOCUMENT**
 - PROBABILISTIC DESCRIPTION OF RISK

In general, the safety analysis reports consider the following types of accident environments (categorized by mission phase):

Prelaunch, Launch, and Ascent Phases:

- Explosion overpressure
- Projectile impact
- Land or water impact
- Liquid propellant fire
- Solid propellant fire
- Sequential combinations of the above

Orbit and/or Flight Trajectory Phases:

- Reentry
- Land or water impact
- Postimpact environment (land or water)

On-orbit contingency options (including retrieval) are considered as appropriate. Fig. 4 shows the kinds of accidents considered for the originally proposed Shuttle/Centaur launch of the Galileo and Ulysses spacecraft (9,10).

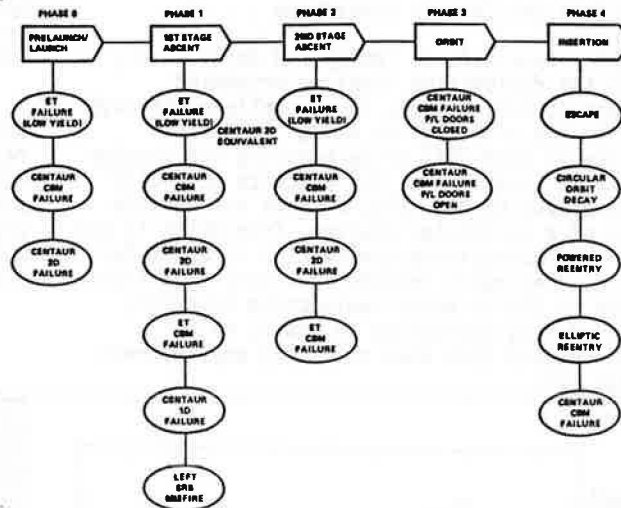

Figure 4. Postulated Mission Accidents for a Space Shuttle/Centaur Launch

From the foregoing it is clear that there must be a close working relationship between the launching/using agency and the DOE if a meaningful and realistic safety analysis is to be undertaken. Generally, the interagency agreement defines the responsibilities of the two agencies with the launching/using agency being responsible for providing information about the mission, including nominal and off-nominal events with probabilities and environments. DOE is responsible for determining through tests and/or analyses how the NPS will respond. All of this information is summarized in the SARs.

Risk Analysis

Because even the most reliable systems pose a finite failure probability, there is a requirement for safety analyses of NPS. Since the mid-1960s these safety analyses have been based upon probabilistic risk assessments. In fact, the U.S. space nuclear safety program pioneered the use of probabilistic risk analysis techniques to assess the safety of NPS. Risk analysis, as used in this context, refers to a quantitative assessment of the potential for human exposure to radiation resulting from the use of a NPS in a space application. (Exposure in this context refers to radiation exposure in excess of natural background radiation.) (3).

The conduct of a risk analysis for a space mission using nuclear power requires: (8)

- Definition of potential mission accidents and probabilities.
- Determination of the types and severity of the resulting accident environments or stresses on the nuclear system.
- Testing and/or analyzing the nuclear system to determine responses to the various accident environments.
- Organization of the information on accidents, probabilities, and system responses into event trees for each mission phase (phases oriented to the potential for human risk).
- Analysis of radiological risk using radionuclide environmental pathway and dose models and world wide data bases.
- Appropriate emergency planning, launch safety preparations, and real time accident analysis and recovery capability.

Ref. 10 describes in more detail the development and implementation of a space nuclear safety program that follows this logic.

For any given mission or mission phase it is possible to postulate a spectrum of accidents some of which may lead to deleterious consequences. The objective of a risk analysis is to put all the accident scenarios and their potential consequences into perspective, so that individual accidents, mission phases, and the overall mission can be evaluated in terms of risk, and those accidents leading to the highest risk are identified.

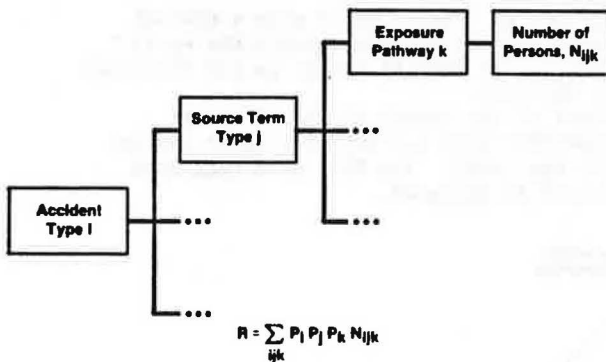

where

- R = Overall Mission Risk Index in Terms of an Expectation of the Number of Persons Receiving a Dose Greater than a Given Dose Level D
- P_i = Probability of Accident Type i.
- P_j = Conditional Probability of Release Type j Given Accident i
- P_k = Conditional Probability of Exposure Pathway k Given Accident Type i and Release Type j
- N_{ijk} = Number of Persons Receiving a Dose Greater than Dose Level D Given Accident i, Release Type j, and Exposure Pathway k

Figure 5. Process for Determining Overall Mission Risk Evaluation

The term "risk" can be defined in many ways. For the purpose of the SARs for the Galileo and Ulysses missions, risk was considered to be an expectation of radiological consequences to the exposed population in a probabilistic sense, and defined for a given accident scenario and release condition as the product of total exposure probability and

radiological consequence. The risk of any accident, mission phase, or the overall mission was then defined as the sum of the risks associated with the accident, mission phase or overall mission, respectively. The concept of risk is more quantitatively defined in Fig. 5. The evaluation of the radiological consequences of any postulated RTG fuel release to the environment from an assumed accident is shown diagrammatically in Fig. 6. (9). Population exposure resulting from a given accident can be described in terms of the distribution of number of persons as a function of dose (or total body burden) received, as shown in Fig. 7. (9).

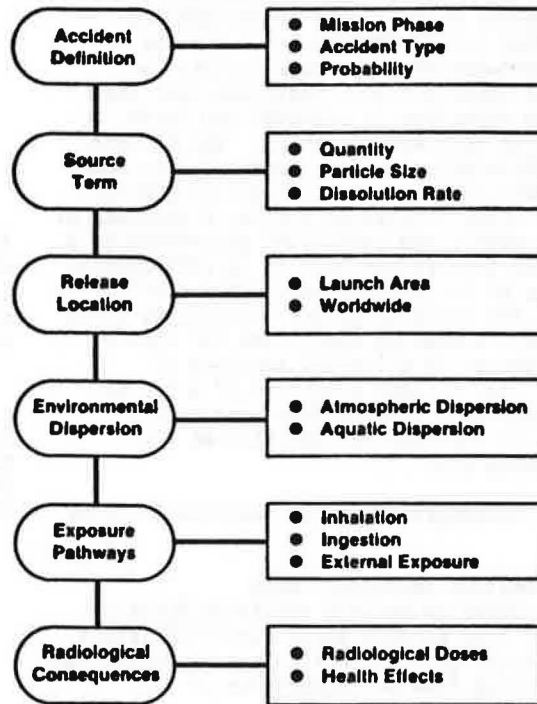

Figure 6. Process for Conducting Radiological Consequence Analysis

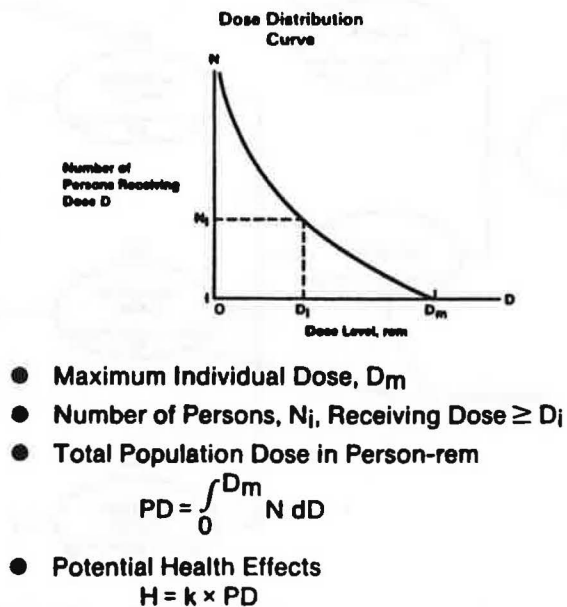

Figure 7. Measures of Radiological Consequences

In order to present the NPS response to the various accident scenarios in a logical sequence of cause and effect, detailed event trees are constructed for each mission phase and for each type of accident to aid in evaluating those situations that can result in consequences to the public. As defined earlier, the assessment of risks involved as the result of any potential accident is based on the probabilities of occurrence for each event in the sequences, including the probabilities of the accident environments involved (see, for example, Fig. 5) (9).

Each event tree is a graphical representation of potential causal sequences for imposing physically severe environments on the NPS and begins with the phase identification and the distinction between mission phase success and failure. The success branch indicates that the mission phase objective is achieved and leads directly to the next mission phase. The failure branch is subdivided, as conditions require, into various primary initiating situations or events. From each of these initiating events, a sequence of intermediate events and conditions progresses to a terminal event that either results in consequences to the public or no consequences to the public. In this manner, the event trees are constructed based on the accident scenarios identified for each of the mission phases in a logical sequence of occurrence. Fig. 8 shows a portion of a typical event tree, called a Failure/Abort Sequence Tree (FAST), used in the FSAR for the Galileo and Ulysses missions (9).

Radiological consequences can be reported in terms of:

- The maximum individual dose
- The number of persons receiving doses or total body burdens above specified levels.
- The total population exposure in person-rem resulting from an integration of the distribution.
- The health effects.

For the Galileo and Ulysses FSAR, three types of potential fuel release cases were identified in the risk analysis:

- Most probable release - that FAST sub-branch in a phase with a predicted fuel release having the highest probability. This included any associated or sequential related source terms.
- Maximum case - the combination of events in a FAST sub-branch having the largest total release. This includes any associated or sequential related source terms selected to maximize the risk. A maximum release was identified for each of the mission phases.
- Release expectation case - a summary characterized by a probability weighted source term based on all the identified predicted fuel release events. This case included all the FAST branches following the level at which the expectation was reported.

In general, emergency planners are most interested in the "most probable" and the "maximum" cases. The overall release expectation risk value is the parameter generally reported to decisionmakers because it presents a balanced overall assessment of the mission risk.

The SARs have a very practical aspect in that they can be of use to emergency planners in responding to accidents that could occur. The United States has had three accidents involving NPS:

- Failure of Transit 5BN-3 with a SNAP-9A power source to achieve orbit (21 April 1964). The SNAP-9A burned up and dispersed as designed.
- Abort of the launch of the Nimbus-B1 satellite with two SNAP-19B power sources (18 May 1968). The RTGs were recovered intact as designed.

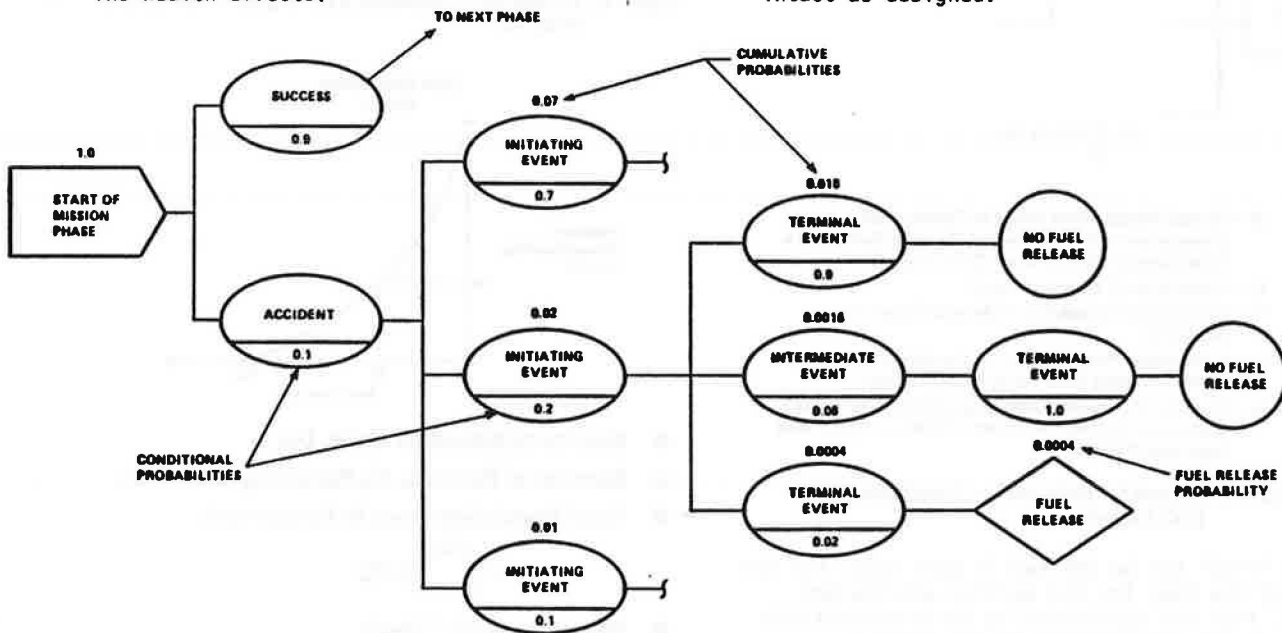

Figure 8. Simplified Failure/Abort Sequence Tree (FAST) Displaying One of Its Sub-Branches

- Damage of the Apollo 13 spacecraft after a successful launch on 11 April 1970 leading to the intact reentry (as designed) of the SNAP-27 fuel cask over the South Pacific Ocean on 17 April 1970.

A fourth incident affected the SNAP-10A reactor, which was successfully launched on 3 April 1965. Following approved guidelines the spacecraft was placed in a high altitude orbit and the reactor was not started until this altitude was confirmed. The reactor operated for 43 days when a shutdown was safely effected following a malfunction of a voltage regulator on the spacecraft payload (not on the reactor).

In each case cited, the NPS performed as they were designed to do. The existence of SARs coupled with teams of safety experts have provided decisionmakers with the necessary information to select the appropriate responses. The SARs also served to guide designers in improving the safety margins of succeeding NPS.

Conclusions

Overall the flight safety review process as developed and implemented in the U.S. has been successful and accepted at the various involved levels of government. These procedures are consistent with the recommendations of the WGNPS and have led to a rigorous space nuclear safety program that provides for the testing and analysis of NPS intended for use in outer space prior to their actual use. The safety of these NPS space missions is assessed by using probabilistic risk analysis techniques. The SARs provide a project assessment of the risks while the SER provides an independent assessment of the risks by the INSRP. A coordinated SER is used by decisionmakers in the launch approval process to evaluate the risks and benefits of a given nuclear-powered space mission.

References

1. G. L. Bennett, J. J. Lombardo, and B. J. Rock, "Nuclear Electric Power for Space Systems: Technology Background and Flight Systems Program", Paper 819181, Proceedings of the 16th IECEC, 9-14 Aug. 1981, Atlanta, Georgia.
2. T. B. Kerr, "Procedures for Securing Clearance to Launch Reactors," Proceedings of a Symposium, Advanced Compact Reactor Systems, 15-17 Nov. 1982, National Academy of Sciences, Washington, D.C.
3. G. L. Bennett, "Overview of the U.S. Flight Safety Process for Space Nuclear Power," Nuclear Safety, (22)4: 423-434, July-Aug. 1981.
4. United States of America, "Criteria for the Use of Nuclear Power Sources (NPS) in Outer Space," working paper submitted by the United States to the United Nations Working Group on the Use of Nuclear Power Sources in Outer Space, U.N. Document A/AC.105/C.1/WG/V/L.8, United Nations, 23 Jan. 1980.
5. "Report of the Working Group on the Use of Nuclear Power Sources in Outer Space on the Work of Its Third Session," Annex II of Report of the Scientific and Technical Subcommittee on the Work of Its Eighteenth Session, U.N. Document A/AC.105/287, 13 Feb. 1981.
6. G. L. Bennett and D. Buden, "Use of Nuclear Reactors in Space," The Nuclear Engineer, 24(4): 108-117, July/Aug. 1983.
7. Federal Emergency Management Agency, Federal Radiological Emergency Response Plan, Concurrency by all Twelve Federal Agencies and publication as an Operational Plan; Notice Fed. Regist. 50(217): 46542-46570.
8. R. W. Englehart, "Mechanics of Space Nuclear Safety," in Space Nuclear Power Systems 1984, Orbit Book Co., Malabar, FL (1985).
9. General Electric Co. and NUS Corp., Final Safety Analysis Report for the Galileo Mission and the Ulysses Mission, GESP-7200, General Electric Co., King of Prussia, PA, and NUS-4784, NUS Corp., Gaithersburg, MD, 8 Oct. 1985 and 17 Dec. 1985 (revision).
10. G. L. Bennett, et al., "Development and Implementation of a Space Nuclear Safety Program," to be published in Space Nuclear Power Systems 1987.
11. Canada, "The Elaboration of Draft Principles Relevant to the Use of Nuclear Power Sources in Outer Space," working paper submitted by Canada to the Legal Subcommittee of the U.N. Committee on the Peaceful Uses of Outer Space, U.N. Document A/AC.105/C.2/L.154/Rev. 1, United Nations, 12 Mar. 1987.

This page intentionally left blank.