

Information Operations in Operations Enduring Freedom and Iraqi Freedom – What Went Wrong?

**A Monograph
by
Major Joseph L. Cox
US Army**



**School of Advanced Military Studies
United States Army Command and General Staff College
Fort Leavenworth, Kansas
AY 05-06**

REPORT DOCUMENTATION PAGE			Form Approved OMS No. 0704-0188		
The public reporting burden for this collection of information is estimated to average 1 hour per response, including the time for reviewing instructions, searching existing data sources, gathering and maintaining the data needed, and completing and reviewing the collection of information. Send comments regarding this burden estimate or any other aspect of this collection of information, including suggestions for reducing the burden, to Department of Defense, Washington Headquarters Services, Directorate for Information Operations and Reports (0704-0188), 1215 Jefferson Davis Highway, Suite 1204, Arlington, VA 22202-4302. Respondents should be aware that notwithstanding any other provision of law, no person shall be subject to any penalty for failing to comply with a collection of information if it does not display a currently valid OMB control number.					
1. REPORT DATE (DD-MM-YYYY) 25-05-2006		2. REPORT TYPE MONOGRAPH		3. DATES COVERED (From - To) SEPT 2005-MAR 2006	
4. TITLE AND SUBTITLE Information Operations in Operations Enduring Freedom and Iraqi Freedom – What Went Wrong?			5a. CONTRACT NUMBER		
			5b. GRANT NUMBER		
			5c. PROGRAM ELEMENT NUMBER		
6. AUTHOR(S) MAJ Joseph L. Cox			5d. PROJECT NUMBER		
			5e. TASK NUMBER		
			5f. WORK UNIT NUMBER		
7. PERFORMING ORGANIZATION NAME(S) AND ADDRESS(ES) School of Advanced Military Studies 250 Gibbon Ave Ft. Leavenworth, KS 66027			8. PERFORMING ORGANIZATION REPORT NUMBER		
9. SPONSORING/MONITORING AGENCY NAME(S) AND ADDRESS(ES) Command and General Staff College 1 Reynolds Ave Ft. Leavenworth, KS 66027			10. SPONSOR/MONITOR'S ACRONYM(S) CGSC, SAMS		
			11. SPONSOR/MONITOR'S REPORT NUMBER(S)		
12. DISTRIBUTION/AVAILABILITY STATEMENT APPROVED FOR PUBLIC RELEASE; DISTRIBUTION IS UNLIMITED					
13. SUPPLEMENTARY NOTES					
14. ABSTRACT There are essentially three issues commanders must confront to integrate IO: doctrine, intelligence support to IO and resourcing the IO efforts. First, Army doctrine does not provide commanders adequate guidance for integrating IO into their operations. Second, IO requires proper intelligence support to be effective, but intelligence doctrine and resourcing do not allow intelligence support to IO to be effective. Third, the Army has not resourced itself to conduct IO in an effective manner. As a result of these three issues with the Army's concept of IO, commanders just do not understand how to integrate IO. This monograph will provide a series of recommendations that if implemented will help prepare commanders for the task of integrating IO. Those recommendations include doctrinal changes and modifications, organizational changes, training requirements, material resourcing requirements, leadership and education requirements, and personnel resourcing requirements. If implemented these recommendations will make long-term changes to how the Army prepares commanders to integrate IO into their operations					
15. SUBJECT TERMS Information Operations, Operation Iraqi Freedom, OIF, Operation Enduring Freedom, OEF, CPA, Bremer, Third Army, USCENTCOM, Iraq, Afghanistan					
16. SECURITY CLASSIFICATION OF:			17. LIMITATION OF ABSTRACT (U)	18. NUMBER OF PAGES 133	19a. NAME OF RESPONSIBLE PERSON
REPORT (U)	b. ABSTRACT (U)	c. THIS PAGE (U)			19b. TELEPHONE NUMBER (Include area code) (913) 758-3300

SCHOOL OF ADVANCED MILITARY STUDIES

MONOGRAPH APPROVAL

Information Operations in Operations Enduring Freedom and Iraqi Freedom –
What Went Wrong?

Approved by:

Charles N. Eassa, LTC, FA

Monograph Director,
School of Advanced
Military Studies

Kevin C.M. Benson, COL, AR

Director,
School of Advanced
Military Studies

Robert F. Baumann, Ph.D.

Director,
Graduate Degree
Programs

Abstract

INFORMATION OPERATIONS IN OPERATIONS ENDURING FREEDOM AND IRAQI FREEDOM – WHAT WENT WRONG? by Major Joseph L. Cox, US Army, 124 pages.

This monograph examines the integration of Information Operations (IO) during Operations Enduring Freedom (OEF) and Iraqi Freedom (OIF). As a rule, most commanders considered IO ineffective because IO was unable to respond to the complex environments of Afghanistan and Iraq. This monograph examines how the Army prepared commanders to integrate IO into operations in Afghanistan and Iraq. Both theaters offer good examples of how commanders integrated IO effectively and how commanders failed to integrate IO effectively.

There are essentially three issues commanders must confront to integrate IO: doctrine, intelligence support to IO and resourcing the IO efforts. First, Army doctrine does not provide commanders adequate guidance for integrating IO into their operations. Doctrine presents IO in a disjointed manner and as a function that is essentially separate from the commander's other requirements and missions, not as something that must be integrated into all his requirements and missions. Second, IO requires proper intelligence support to be effective, but intelligence doctrine and resourcing do not allow intelligence support to IO to be effective. Intelligence doctrine provides little practical guidance on support to IO and intelligence processors and analysts are currently unprepared to provide the in depth analysis of the information environment IO requires. Third, the Army has not resourced itself to conduct IO in an effective manner. There are currently only sixty percent of the required IO officers in the Army. None of the Army Battle Command Systems (ABCS) can adequately portray the information environment, nor can they process the reporting that would allow them to analyze and portray the information environment. Professional Military Education and unit training programs do not stress IO as an integrated function and do not present commanders with realistic situations in which they must achieve success in the information environment. As a result of these three issues with the Army's concept of IO, commanders just do not understand how to integrate IO.

After examining why and how commanders were unable to integrate IO effectively, this monograph will provide a series of recommendations that if implemented will help prepare commanders for the task of integrating IO. Those recommendations include doctrinal changes and modifications, organizational changes, training requirements, material resourcing requirements, leadership and education requirements, and personnel resourcing requirements. Some of these recommendations are already in the process of being implemented, others could be implemented relatively quickly, while the remaining recommendations will need more detailed study to fully implement so as to make long-term changes in the Army and how the Army prepares commanders to integrate IO.

The appendices provide the reader with more detailed information on IO that could not realistically be included in the length requirements of this monograph. While reading them is not essential to understanding the issues presented in the monograph, the appendices do help in providing more depth or understanding of the subjects presented in the main body of the monograph. These appendices discuss the relationship of Public Affairs to IO, provides an overview of IO organizational and equipment capabilities of the units identified in the main body of the monograph and provides a more detailed breakdown of the various units which served in OEF and OIF.

TABLE OF CONTENTS

INTRODUCTION.....	1
ARMY DOCTRINE AND IO.....	10
INTELLIGENCE SUPPORT TO IO.....	17
Intelligence Preparation of the Battlefield.....	17
Assessment.....	20
Intelligence Resourcing.....	22
RESOURCING IO.....	25
Manpower.....	25
Equipment.....	28
Training.....	30
Operation Enduring Freedom.....	32
Operation Iraqi Freedom.....	40
INTEGRATING IO.....	55
Defeating the Taliban.....	56
Afghan National Elections.....	60
Initial Operations in Iraq.....	63
The CPA assumes control.....	69
CONCLUSIONS AND RECOMMENDATIONS.....	76
Doctrine.....	78
Organization.....	79
Training.....	80
Materiel.....	80
Leadership and Education.....	81
Personnel.....	81
APPENDIX A: IO AND PUBLIC AFFAIRS.....	83
APPENDIX B: IO AND TARGETING.....	88
Example Integration of MDMP, Targeting and IO.....	90
APPENDIX C: IO UNIT STRUCTURES AND EQUIPMENT CAPABILITIES.....	97
PSYOP Units and Equipment.....	97
EC-130E/J Commando Solo.....	97
Special Operation Media Systems – B (SOMS-B).....	99
Tactical PSYOP Battalion.....	101
Tactical PSYOP Company.....	102
Mobile Public Affairs Department.....	103
Combat Camera.....	104
EC-130H Compass Call.....	106
EA-6B Prowler.....	108
APPENDIX D: SELECTED UNIT IO STRUCTURES AND ORGANIZATIONS.....	109
BIBLIOGRAPHY.....	125

List of Figures

Figure 1: Influencing the Neutrals.....	5
Figure 2: Theoretical Doctrinal Hierarchy	13
Figure 3: Contemporary Operating Environment.....	18
Figure 4: OEF-1.....	35
Figure 5: OEF-2 & 3	36
Figure 6: OEF-4.....	37
Figure 7: OEF-5.....	38
Figure 8: OEF-6.....	39
Figure 9: OIF-1 Major Combat Operations.....	41
Figure 10: Post MCO, after CPA Takes Control.....	45
Figure 11: OIF-2.....	49
Figure 12: OIF-3.....	51
Figure 13: Al Iraqiya Television Coverage	53
Figure 14: OEF Daily Pentagon Press Breifing Slide	59
Figure 15: EC-130J Commando Solo.....	97
Figure 16: SOMS-B in Afghanistan	99
Figure 17: Tactical PSYOP Battalion.....	101
Figure 18: Tactical PSYOP Company.....	102
Figure 19: MPAD.....	103
Figure 20: Combat Camera Detachment	104
Figure 21: EC-130H Compass Call over the desert	106
Figure 22: Two EA-6Bs refueling over the desert	108
Figure 23: Pre-modular Divisional IO structure.....	109
Figure 24: Typical Corps IO Organization.....	110
Figure 25: Force XXI IO Organizations.....	111
Figure 26: Modular Division IO structure.....	112
Figure 27: CJTF-76 in OEF-5	113
Figure 28: CFC Strategic Communications	114
Figure 29: 4ID Headquarters IO Structure	115
Figure 30: V Corps IO Cell before May 2003.....	116
Figure 31: CJTF-7 IO Cell	116
Figure 32: CPA STRATCOM	117
Figure 33: 1ID IO Structure	119
Figure 34: 1CD IO Structure	120
Figure 35: MNC-I IO Structure.....	121
Figure 36: MNF-I STRATCOM	122
Figure 37: 3ID IO Structure for OIF-3	123

List of Tables

Table 1: Army IO Doctrine re-write dates.....	12
Table 2: IO Field Grade Manning Requirements	26
Table 3: Targeting and the MDMP	89
Table 4: Example MDMP/Targeting Crosswalk Integrating IO	95
Table 5: Commando Solo Transmission Capabilities	98
Table 6: SOM-S Transmission Capabilities	100

INTRODUCTION

To subjugate an enemy's army without doing battle is the highest of excellence.

– Sun Tzu, The Art of War.

Conducting operations that influence the enemy's will to fight is as old as warfare itself.

History is replete with examples of Military Deception (MILDEC), Psychological Operations (PSYOP), Electronic Warfare (EW), Operations Security (OPSEC) and the destruction of the enemy's Command and Control (C2) Nodes. The US military even developed doctrine to conduct Command and Control Warfare (C2W). In the 1990s, a concept called Information Operations (or Information Warfare) began to take hold, first in the Joint community and then in the Army. US Operations in the Balkans posed renewed challenges to the US military as it strove to change attitudes and perceptions of combatant and non-combatants as the Military enforced United Nations and NATO mandates concerning Bosnia-Herzegovina and Kosovo. In 1999, the Army created the Information Operations (IO) Career Field to provide commanders with a dedicated IO staff to ensure the unit plans and executes IO carefully.

While the military would learn many valuable lessons from operations in the Balkans, the real test of IO would come during Operations ENDURING FREEDOM and IRAQI FREEDOM (OEF and OIF). It was during these operations that the military would test and expand the tactics, techniques and procedures (TTPs) developed in the Balkans crises. The initial feedback from commanders in the field and senior leaders was less than enthusiastic. It is still common to hear phrases like “We are losing the information war” or “We face information overmatch and are not competing effectively.” What is it about the Army's implementation of IO that produced lackluster results in Afghanistan and Iraq?

A review of unit after action reviews (AARs), analysis from the Center for Army Lessons Learned (CALL), and feedback from commanders in the field reveal four significant trends that if

corrected will allow IO to be a force multiplier throughout the full spectrum of military operations. In summary, those four trends are: Army Doctrine was not adequate to provide guidance for shaping the information environment in full spectrum operations at all Army echelons; Intelligence support to IO was inadequate; Units lacked the resources to integrate IO in to their operations; and commanders, staffs and IO officers did understand how to integrate IO with all the tools (Civil Affairs, Public Affairs, maneuver, fire support, logistics, etc.) available to them to shape the information environment in which they would operate.¹

Successful operations require commanders to be personally involved in the planning and execution of their unit's operations. How the commander is involved in the unit's planning and execution of his plan is in essence the art of battle command. Furthermore, FM 3-0 provides clues as to how this occurs when it states:

Commanders, assisted by the staff, *visualize* the operation, *describe* it in terms of intent and guidance, and *direct* the actions of subordinates within their intent. Commanders direct operations in terms of the battlefield operating systems (BOS). They directly influence operations by personal presence, supported by their command and control (C2) system.² (emphasis added)

The best commanders are those who are able to take their vision of the battlefield and assist their staffs and subordinate commanders in preparing and executing an operation that uses the units' resources in the most effective manner possible while simultaneously reducing the risk to the unit to a manageable level. Proper utilization of the commander's (and unit's) resources requires a total integration of those resources to ensure they are working to achieve the commander's intended end state.

¹ Center for Army Lessons Learned, *Operation Iraqi Freedom (OIF) CAAT II Initial Impressions Report 04-13* (Fort Leavenworth: May 2004), 1 - 27; Center for Army Lessons Learned, *Information Operations CAAT Initial Impressions Report 05-03* (Fort Leavenworth: May 2005), iv, 1 - 2, 49 - 52; Center for Army Lessons Learned, *Initial Impressions Report: Stability Operations - Support Operations Operation Iraqi Freedom* (Fort Leavenworth: December 2003), 22; *OEF/OIF CAAT Initial Impressions Report: Stability Operations - Support Operations* (Fort Leavenworth: December 2003), 61.

² US Army Field Manual 3-0, *Operations* (Washington, DC: Headquarters, Department of the Army, 2001), 5-1.

For the staff to integrate IO into a unit's operations, it must be a priority for the commander, and expressed such by him. First, a commander must visualize the information environment and how his operation will influence that environment. He must then express his concept of the operation and how the use of information will complement his operation. In some cases, he will describe IO as the decisive operation; in other cases, IO will be a supporting operation. Finally, he directs his subordinates through his intent, which should provide clear guidance for them to execute.

While this process may look good in theory, in practice it rarely occurred as described above. Commanders understood the need to integrate IO, but were struggling with its implementation. This struggle essentially came from a misunderstanding of what IO really was. In the minds of many Army leaders, IO remained a nebulous concept with some sort of focus on shaping people's perceptions and attitudes. Most commanders could recite the definition of IO as "actions taken to affect adversary, and influence others', decision making processes, information and information systems while protecting one's own information and information systems."³ Many commanders have had difficulty articulating a definition of IO beyond the relatively simplistic definition found in Army doctrine. Perhaps it would be better if commanders thought of IO as a combination of four functions: influence, inform, attack and protect, whose coordinated use produces an effect on the battlefield greater than merely adding the results of the individual functions together.

Influence operations are those operations designed to change the behavior of a target audience. In major combat operations, influence operations are primarily against military forces. In stability operations, influence operations are primarily aimed at influencing non-military persons to comply with US (or coalition) instructions or in the case of Counterinsurgency (COIN) operations to influence the populace to support US operations.

³ US Army Field Manual 3-0, *Operations* (Washington, DC: Headquarters, Department of the Army, 2001), 11-16.

If the essence of COIN operations is, as David Galula, one of the preeminent theorists of COIN in the late twentieth century and author of *Counterinsurgency Warfare: Theory and Practice*, stated that separating the insurgents from the populace, then influence operations is the decisive operation in COIN.⁴ If most people fall into three categories, pro-US, pro-insurgent and neutral, then the focus should be on the group that has the most impact on the fight. Given that relatively small percentages (somewhere around 10%) of the population fall on either extreme of the pro-US/pro-insurgent spectrum and will not change their opinions and perceptions, then the High Payoff Target (HPT) in such a scenario is those who have not clearly declared an allegiance, the neutral population. It is the neutral population that allows the insurgents to move and operate with impunity.⁵ Changing the attitude of the neutral populace to a pro-US attitude will cause the insurgents to lose their ability to operate freely. The following diagram depicts methods for influencing the neutral populace. (The diagram is not intended to show that kinetic or non-kinetic are exclusive to either end of spectrum, but rather to show where kinetic and non-kinetic operations would be more likely).

⁴ David Galula, *Counterinsurgency Warfare Theory and Practice* (New York: Frederick A. Praeger, 2000), 77.

⁵ Christopher M. Ford, "Speak No Evil: Targeting a Population's Neutrality to Defeat an Insurgency," *Parameters* (Summer 2005), 53.

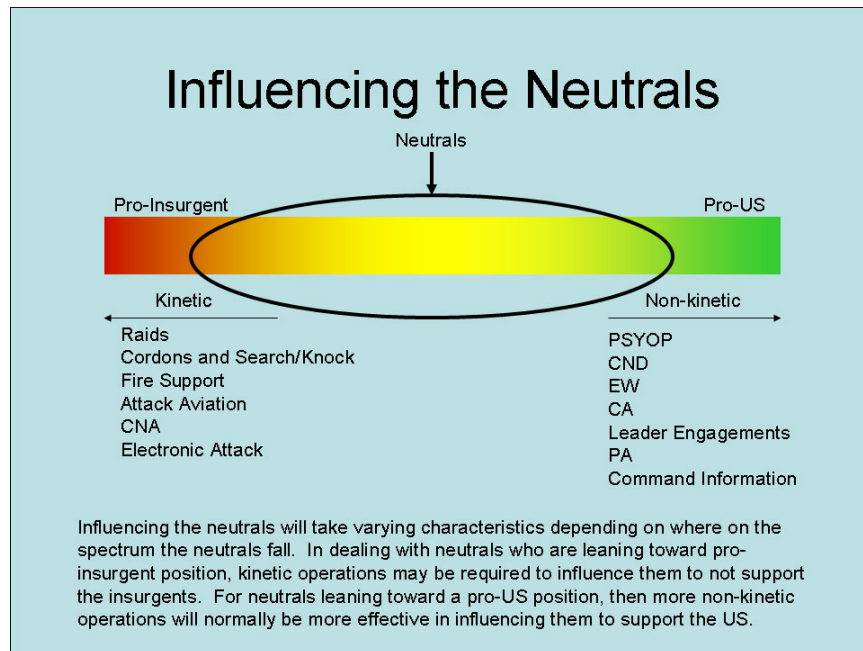

Figure 1: Influencing the Neutrals

While most assume that keeping the neutrals, or fence sitters, from choosing a side, is the key to successful coin operations, in actuality it is by targeting them to gain their support that will ultimately achieve victory in COIN operations.

The inform function of IO is, quite simply, providing target audiences information on US activities, intentions, and operations. Although there may be a secondary influence objective, the primary objective is purely to provide information. PSYOP units call this “Command Information.” In OIF, the effort to inform the Iraqis and the world of progress in Iraq consumed a large percentage of the IO staffs’ time and efforts. Informing can occur through the following methods, Public Affairs (PA), Civil Military Operations (CMO), leader engagements by combat leaders, engagements with the local populace by forces in the course of their operations, and PSYOP.

The attack function of IO is to neutralize, suppress, degrade or destroy an adversary IO capability. When used in conjunction with informing operations and influencing operations, the effect can be multiplied beyond the effect of the initial attack. These attacks can be kinetic or non-kinetic. Types of attacks include but are not limited to; EA; Physical Destruction through

maneuver, fire support or airborne delivery platforms; computer network attacks (CNA); and MILDEC.

The final function of IO is protection. This prevents the adversary from neutralizing, suppressing, degrading, or destroying the friendly IO capability. Protection has two aspects. The first aspect is to protect friendly information capabilities (information and information systems and decision making capabilities). The second aspect is to protect the information environment friendly forces are trying to create. This prevents the adversary from creating an information environment that favors him. Some of the tools available to protect friendly information capabilities include computer network defense (CND), counter-intelligence (CI) operations, counter-propaganda by PA and PSYOP, and radio net encryption.

Commanders must not only ensure that IO is integrated horizontally across the Battlefield Operations Systems (BOS) in his unit, he must also ensure that IO is integrated vertically, that is his intent nests with his higher commander's IO intent. Only when IO is integrated cross-BOS and between echelons of command, can the commander truly be sure he is influencing the information environment, and diminishing the enemy's capability to influence that same information environment. One must remember, these functions are NOT separate, but are interrelated and dependant upon one another to be effective.

Even if commanders understood IO in Afghanistan and Iraq in terms of influence, inform, attack and protect, the Army had not prepared commanders to integrate IO. The remainder of this monograph will discuss how the Army prepared commanders for the task of integrating IO and how commanders chose to resource and integrate IO. Through an understanding of the doctrinal, intelligence and resourcing challenges facing commanders, the reader will gain an appreciation for the decisions commanders faced as to how each commander integrated IO. Examples of how commanders integrated IO will show how commanders made intuitive judgments on how to integrate IO given the lack of doctrinal guidance and resources each commander had available to him.

Chapter Two will focus on Army doctrine and how it fails to adequately provide guidance and give a framework with which commanders can integrate IO into their operations. There are three issues with Army doctrine that cause it to be inadequate to guide IO integration. First, current Army doctrine is in a state of flux and has been for roughly six years as the Army attempts to grapple with the changes in the contemporary operating environment. Many of the changes to doctrine which have occurred since 2001 have yet to propagate through all the Army's doctrine. Second, the current Army doctrinal manuals do a poor job of integrating IO into operations. None of the Army Capstone doctrinal manuals (FM 1-0, FM 2-0, FM 3-0, FM 4-0, FM 5-0 and FM 6-0) presents IO in conjunction with operations. Furthermore, the subject and functional manuals (FM 3-13, FM 6-20-10, etc) also do not present IO as being integrated fully with a unit's operations. Third, current doctrine does not provide guidance for integrating the elements of IO with one another. Because current doctrine is inadequate, training programs based on doctrine are not adequately preparing commanders or their staffs for the task of integrating IO into operations.

Chapter Three will discuss intelligence support to IO. Intelligence must assist the “commander in visualizing his battle space, organizing his forces, and controlling operations to achieve the desired tactical objectives or end-state.”⁶ Two shortcomings in intelligence organizations, however, make them incapable of providing the intelligence the commander needs to influence the information environment. The first shortcoming is in intelligence doctrine as it relates to supporting IO. Intelligence doctrine does not address with sufficient detail the type of information that IO requires. The second shortcoming is the resourcing of intelligence support to IO. These resources include collection assets, analysis tools and trained analysts that understand the information environment.

⁶ US Army Field Manual 2-0, *Intelligence* (Washington, DC: Headquarters, Department of the Army, 2004), 1-1.

Chapter Four will examine IO resourcing. Even though changes to IO force requirements are occurring as the Army transforms in accordance with Task Force Modularity, resources still remain inadequate for the task of integrating IO. With the first truly modular units just beginning their rotations into OIF, it is difficult to determine if resources are truly adequate. Understanding that changes have occurred in the last two years, this chapter will examine how IO tends to be resourced. Using case studies from OEF and OIF, this chapter will show where the most significant shortfalls in resourcing occur. Some of these shortfalls will continue despite the Army's transformation plan.

Chapter Five will address how IO is integrated into operations. The problems with integration stem directly from the lack of guidance in doctrine. Because commanders struggled with how to integrate IO, they each developed their own methods for integrating IO. While some commanders made a deliberate attempt to ensure IO integration, others were less certain and provided little clear guidance for integrating IO. Most failures in integrating IO were a result of the commander failing to visualize the complete operational environment. As a result, commanders viewed IO solely in terms of what was presented in the media and used IO to help spread the good news (inform) rather than change the perceptions of the target audiences (influence) or degrading their adversaries ability to manage perceptions (attack) or even defending the information environment the commander was trying to create in his area of operations (protect).

Chapter Six will summarize the findings on the previous four chapters. It will also address the changes that have occurred in IO based upon the lessons learned in Afghanistan and Iraq. Finally, it will provide a series of recommendations that address Army doctrine, intelligence support to IO, what resources IO needs to be effective, and how to improve commanders, staffs and IO Officers' ability to implement IO.

The appendices will focus on material that will aid the reader in understanding some of concepts presented in the monograph, but the discussion of those topics would not fall cleanly

into the issues presented in the main body of the paper. These topics include a discussion on the relationship of IO and the media, the Army's targeting process, and the development of IO force structures in both Afghanistan and Iraq.

ARMY DOCTRINE AND IO

The Doctrinal concept of information operations (IO) as a combat multiplier seems to be universally misunderstood at nearly every level of the Army.

Center for Army Lessons Learned

If the US Army is, as its leaders have repeatedly stated, a “doctrine-based Army,” then doctrine must form the cornerstone for all Army operations, including the use of IO. Overall, doctrine failed to prepare commanders to integrate IO into their operations. As a result, commanders tended to view IO as “another staff stovepipe with undefined and unresourced missions, a vertical staff effort that does not seem relevant to combat operations.”⁷ There were few principles which guided the integration of IO into a unit’s operation. Of course, part of the problem was that current Army (and to some degree Joint) doctrine has been in a state of transition and has been for the better part of the last five or six years. This caused the emergence of new tactics, techniques and procedures (TTPs) that were not in doctrine, but that have slowly worked their way into doctrine. The second issue with Army doctrine was present even in the newer doctrine material, there was no clear guidance on integrating IO. In some cases, the guidance was vague and sometimes contradictory.

Events since the 11 September 2001 attack on the United States have forced a rethinking of the way the United States applied military forces against complex problems often requiring elusive solutions. Army doctrine writers had to create doctrine in the midst of two conflicting challenges. First, the counterinsurgency operations in Afghanistan and Iraq have forced the military, especially the Army, to consider new ways of US military forces to achieve political

⁷ CALL *Operation Iraqi Freedom (OIF) CAAT II Initial Impressions Report 04-13*, May 2004, 1.

ends. Second, the Army has begun conducting the largest transformation of its structure and organization since World War II. This transformation would not just restructure the Army, but force it to consider new ways of employing its forces.

Transformations are difficult to accomplish under the best of circumstances, but the Army is attempting to transform itself while simultaneously conducting a war. Under normal circumstances, the Army would develop unit designs, create at least an interim doctrine for those units, field new equipment and then transform existing units to the new design, train the newly formed unit for a period of time (usually months) and then certify the unit was ready for deployment. The transformation combined with the requirements of the Global War on Terror required that units transform, train and develop their own TTPs for employing the unit and then shortly thereafter participate in combat operations. In fact, some units who participated in the current OIF rotation shipped their equipment directly to Iraq from one of the Combat Maneuver Training Centers. This pace of transforming deploying has caused doctrine to fall behind situations in the field.

To make matters worse, the traditional model of doctrinal development would require two to three years to re-write a single manual. Under this paradigm, the lessons learned from OIF-1 (2003 – 2004) would just now become part of current doctrine. If one were to take this time frame for re-writing doctrine as a literal requirement, re-writing doctrine would be relatively straightforward. All a doctrinal proponent needed to do was start a new manual and two years later, the Army would publish a new doctrinal manual. That is not, however, the case. The structure of Army doctrine and the need to ensure consistency in approved doctrine means it takes several years for new doctrinal principles to propagate throughout the Army's doctrinal manuals and may take even longer for those principles to become ingrained into the Army's procedures.

The following table shows how some of Army doctrine relating to IO has undergone change. Notice that current targeting doctrine was seven years old when IO doctrine was

updated. The targeting doctrine of 1996 did not include a discussion of non-lethal targeting. For a more thorough discussion of Army targeting doctrine, refer to Appendix B.

Manual	Title	Pub Date	Replaced with	Pub Date
FM 3	Operations	June 2001		
FM 3-05.401	Civil Affairs TTPs	Sep 2003		
FM 3-07	Stability and Support Operations	Feb 2003		
FMI 3-07.22	Counter-insurgency Operations	Oct 2004		
FM 3-55.12	COMCAM	Mar 2003		
FM 3-61.1	Public Affairs TTPs	Oct 2000		
FM 6-02.40	Visual Information Operations	Jan 2002		
FM 6-20	Fire Support in the Air Land Battle	May 1988		
FM 6-20-10	TTP for the Targeting Process	May 1996		
FM 6-20-30	TTP for Fire Support for Division and Corps Operations	Oct 1989		
FM 6-100*	IO	Aug 1996	FM 3-13	Nov 2003
FM 33-1	PSYOP	April 1983	FM 3-05.30	April 2005
FM 33-1-1	PSYOP TTP	May 1994	FM 3-05.301	Dec 2003
FM 34-1	Intelligence and Electronic Warfare (IEW) Operations	Sep 1994	FM 2	May 2004
FM 34-2	Collection Management and Synchronization Planning	Mar 1994		
FM 34-3	Intelligence Analysis	Mar 1990		
FM 34-8	CDRs Handbook on Intelligence	Sep 1992	Obsolete	
FM 34-10	Division IEW Operations	Nov 1986		
FM 34-37	Echelons Above Corps IEW Operations	Jan 1991		
FM 34-45	TTP for Electronic Attack	June 2000		
FM 34-130	IPB	July 1994		
FM 41-10	Civil Affairs	Feb 2000		
FM 46-1	Public Affairs	May 1997		
FM 100-1	The Army	June 1994	FM 1-0	June 2005
FM 101-5	Staff Organization and Operations	May 1997	FM 5-0	Jan 2005
			FM 6-0	Aug 2003

Table 1: Army IO Doctrine re-write dates⁸

In taking over twenty-years (1986 to present) to update doctrine relating to IO, the Army has inadvertently ensured its doctrine for integrating IO would remain disjointed, incomplete and out of date.

⁸ *United States Army Training Support Center Website*. Available from <http://www.adtdl.army.mil>; Internet.

To ensure doctrinal principles remained consistent throughout all the doctrinal manuals, the Army developed a hierarchical approach to structuring doctrine. The hierarchical concept was actually straightforward. The Capstone manuals introduced broad principles. Specific subject manuals (IO, targeting, IPB, etc) provided direction on implementing those principles. Finally, unit manuals provided guidance on implementing specific subject matter direction that was appropriate for the unit based on its organization, resources and capabilities. Other manuals (Operations Manuals), such as FM 3-7 (Stability Operations) provided guidance for conducting operations in that unique environment. These manuals were cross-BOS in that they provided direction for all the BOSs in that environment.

The following chart depicts how this system was supposed to work. In practice, this was usually less clear. The chart has been simplified for ease of understanding.

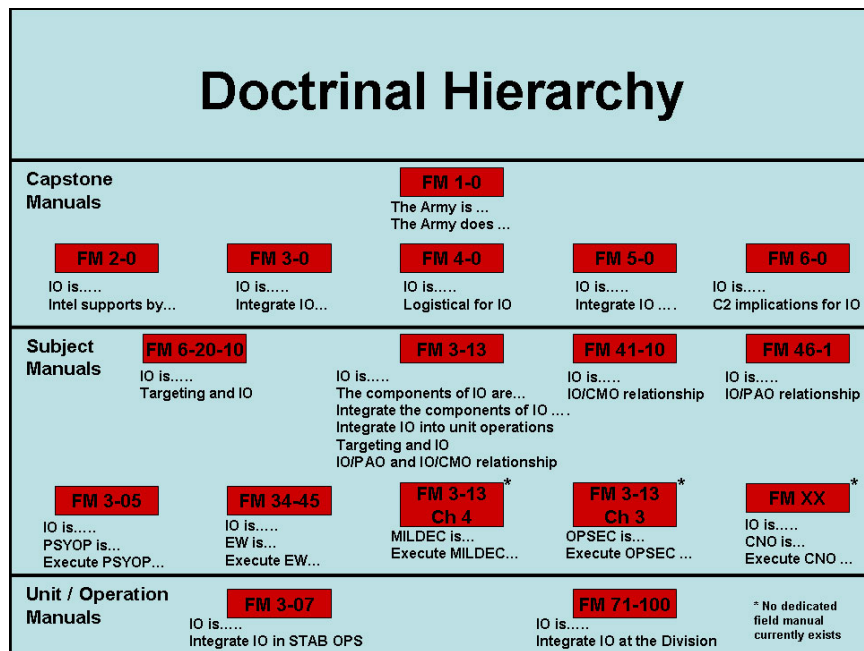

Figure 2: Theoretical Doctrinal Hierarchy

Using Figure 2 as a framework, what should be represented in doctrine? First, all doctrinal manuals needed to have the same definition of IO. For manuals written after 2001 this was indeed the case. Unfortunately, as discussed in Chapter One, the definition did little to clarify in commanders' minds what IO really was. Recently, commanders have come to perceive

IO almost from a purely non-kinetic point of view and determined the effectiveness of IO based on what actions and activities made it on the international news circuit and whether that press coverage was positive or negative. The tendency became to dismiss reporting that was repeatedly negative because it was based on the bias of an anti-US organization. Examples of dismissing negative press reporting included the Army's responses to negative reporting from Al Jazeera, Agence-France Presse, and even in some cases, the BBC or the *New York Times*.

Second, each Capstone manual needed to provide guidance for IO within their subject matter. This needed to start with FM 1-0 mentioning IO in full spectrum operations, and not limit IO to information superiority. FM 2-0 needed to clearly identify support requirements for IO to lay the foundation for subsequent intelligence manuals to build a more in depth understanding of intelligence support to IO. FM 3-0 had to stress that IO had a role in influencing the environment in which all forces will operate. The manual needed to provide guidance on using "non-IO" resources to achieve IO objectives. It also needed to provide commanders guidance on how to visualize, describe and direct what he wanted to achieve in the information environment as a subset of the overall operational environment. FM 4-0 had to address how IO affects CSS operations. The manual had to show how IO could help CSS units accomplish their mission and how these units could participate in achieving an information objective. FM 5-0 needed to include planning requirements for the information environment and how best leverage the information environment so the commander could achieve his end state. Finally FM 6-0 had to include a discussion on how the information environment could affect the commander's ability to exercise effective command and control of his forces.

Third, IO specific doctrine as expressed in FM 3-13 needed to provide not only guidance on how to integrate into Army operations, but it also had to provide guidance on integrating the various elements of IO with each other to achieve the commander's objectives and ultimately his end state. Part of the discussion on integration needed to include a discussion of the capabilities and limitations of the elements of IO available to an organization to conduct IO. This discussion

needed to include the various systems used by PSYOP, EW, and Combat Camera to support IO. This discussion should not merely discuss core element tools, but should also include tools such as maneuver forces, fire support, CA, and PA. While FM 1-13 stated requirements to integrate, it provided few details on how to achieve that integration. It also did not address integrating IO into maneuver, fire support, logistics or any other function a unit could perform.

Fourth, the IO element (core, related and supporting) manuals needed to clearly articulate the role of that element in a unit's overall effort to shape the information environment. It was not enough to simply state what EW, or PSYOP, or PA, or even CMO was, but the doctrine had to provide some basis for understanding how those elements related to the other elements of IO. Within these manuals, there needed to be clear guidance on who is responsible for shaping the information environment, especially in the areas of PSYOP and PA. Currently no manual provided that kind of contextual data or guidance delineating responsibility.⁹

Next unit (such as FM 71-100, *Division Operations*) manuals needed to provide clear guidance on integrating IO at that specific unit based on the resources that unit could have and the types of missions that unit could face. By the same token, operation specific (such as FM 3-07 *Stability Operations*) manuals needed to provide clear guidelines on integrating IO within that type of operation. In this case, doctrine needed to include the types or resources most effective in meeting the IO integration requirements for the operation.

In closing the discussion on Army doctrine and IO integration, the reader should remember the following three points. First, Army doctrine is in a state of flux caused by a greater understanding of the current operating environment and the Army-wide transformation currently underway. Because of the nature of the transformation, it will take time for doctrinal re-writes to run their course and reach the army in the field. Second, the structure of Army doctrine is

⁹ There is currently no Army doctrinal manual that dedicated entirely to MILDEC or OPSEC. OPSEC is covered in Chapter 3 of FM 3-13. Outside of FM 3-13, *Information Operations*, OPSEC is presented solely as protecting Essential Elements of Information (EEFI). MILDEC is covered in Chapter 4 on FM 3-13.

designed to ensure consistency of doctrinal principles throughout all Army manuals, but that consistency will only work when proponents of the various Army doctrinal manuals ensure their manuals meet the intent of the hierarchical structure beyond a numbering scheme. Third, current doctrine does not provide guidance on integrating IO into unit operations. Doctrine generally dealt with IO as separate from unit planning and operations. To be effective, a discussion of IO must occur within the context of unit operations and planning processes. Doctrine must view IO integration in the same manner it views river crossings or counter fire – an activity that requires close coordination with all BOS elements to be successful.

A solid baseline doctrine allows the commander to understand all the tools at his disposal. These tools will help him to visualize the operating environment in its totality, not just in terms of military forces. Once the commander has a clear vision of the operating environment, he can then describe his framework for achieving his end state and then direct his staff and subordinates on what they must do in order for the unit to obtain the end state the commander desires. Once doctrine clearly articulates IO as an integrated function, much like river crossing operations or counterfire operations, then commanders will no longer view IO as “another staff stovepipe with undefined and unresourced missions, a vertical staff effort that does not seem relevant to combat operations.”¹⁰

¹⁰ CALL *Operation Iraqi Freedom (OIF) CAAT II Initial Impressions Report 04-13*, May 2004, 1.

INTELLIGENCE SUPPORT TO IO

Understanding the effect of operations as seen through the lens of the Iraqi culture and psyche is a foremost planning consideration for every operation.

MG Peter Chiarelli¹¹

Intelligence support to IO is critical to achieving operational success. As a key to visualizing the operational environment, intelligence helps the commander understand what elements of the information environment the commander needs to effect in order to achieve his end state. The commander can then describe how he wants to affect those elements by articulating which information objectives were decisive and which elements were supporting operations. Focused intelligence collection, directed through Priority Intelligence Requirements (PIR), allows the commander to determine whether he is achieving his objectives and getting closer to achieving his end state.

Intelligence faced two challenges in providing support to IO. First, intelligence doctrinal shortcomings did not lay a foundation that allowed the G2 to properly analyze the information environment. The most critical doctrinal shortcoming involved Intelligence Preparation of the Battlefield (IPB). Second, resourcing issues prevented the G2 from dedicating assets that would collect, process, analyze and disseminate intelligence reporting that provided details on the information environment.

Intelligence Preparation of the Battlefield

Intelligence Preparation of the Battlefield (IPB) helped the commander visualize the all the dimensions of the operational environment. Combined with the an analysis of the interaction of the critical variables with the six dimensions of the operational environment, the commander began to understand his environment and what he had to do to effect that environment and

¹¹ Peter W. Chiarelli, "Winning the Peace, the Requirement for Full-Spectrum Operations." *Military Review* (July-August 2005), 14.

achieve his desired end state. If the IPB did not adequately address the information environment, then the commander could not understand that aspect of the environment and as a result, would not address the information environment. Figure 5 depicts the operational environment and the critical variables that IPB must provide analysis for. (The reader should recall that each dimension interacts with every other dimension, so affecting one dimension has an affect on all dimensions.)

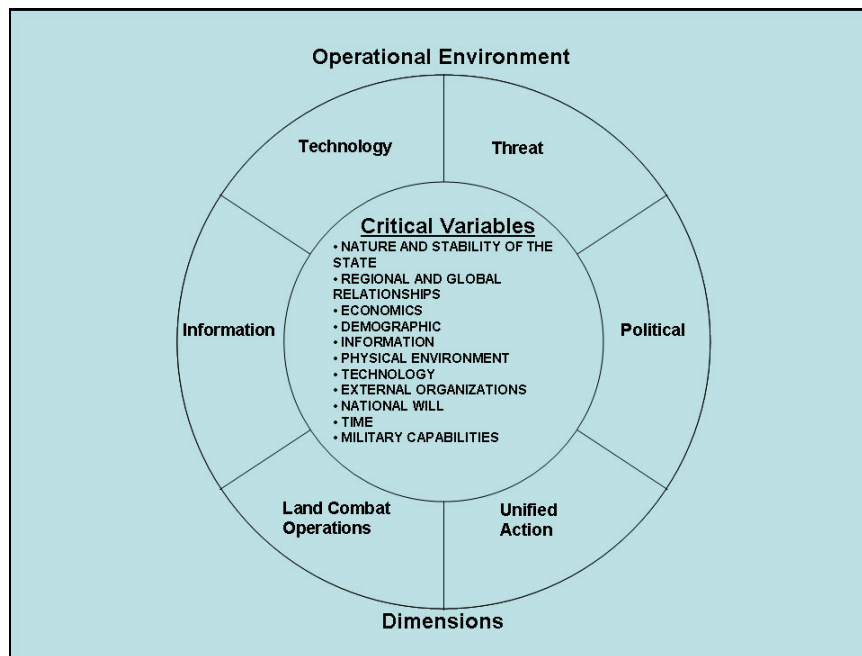

Figure 3: Contemporary Operating Environment¹²

Even though this chart clearly indicates that intelligence analysts must analyze the entire environment, including the information environment, intelligence doctrine only provides details on analysis in threat dimension and land combat operations of the operational environment. Intelligence doctrine focused on analysis supported by technical collection methods (primarily SIGINT and IMINT) with limited confirmation from HUMINT (SALUTE) reports while essentially ignoring anything that did not fall neatly into a technical realm.

¹² US Army Field Manual 2-0, *Operations* (Washington, DC: Headquarters, Department of the Army, 2004), 1-24.

A recent Rand Study on intelligence support to IO during OIF determined that intelligence failed in providing the commanders with the level of support they required to conduct their operations. According to this study, the failure stemmed from a failure of intelligence doctrine to address adequately IO support requirements. The study acknowledged a requirement to support IO: “Successful IO require a thorough and detailed IPB. IPB includes information about enemy capabilities, decision-making style, and information systems. It also considers the effect of the media and the attitudes, culture, economy, demographics, politics, and personalities of people in the AO.”¹³ The issue lies in the fact that intelligence doctrine does not provide a method to achieve the results the commanders needed. The study presented two key reasons for intelligence failures in Iraq. First, “although intelligence doctrine implied support to IO, there was no systematic method or analytical model for providing intelligence support to IO.”¹⁴ Second, the “current IPB process (as defined in FM 34-1 and FM 2-01.3) requires more detailed analysis to account for IO requirements.”¹⁵

Basically, IPB had to identify to the commander, what elements of the information environment he could affect, how to affect those areas and what most likely responses to his attempts to influence the information environment would be. IPB also had to identify what elements in the information environment he should protect against. This required a detailed study of at least the culture, religion, key communicators, demographics, history, decision making processes, and information systems of a given information and operational environment. Much of this information should appear in Appendix 1 (Intelligence Estimate) of Annex B (Intelligence) of the Operations Order. But Army intelligence doctrine does not provide any guidance on what information should be in the intelligence estimate.

¹³ US Army Field Manual 3-0, *Operations* (Washington, DC: Headquarters, Department of the Army, 2001), 11-17.

¹⁴ John Strykula, *Intelligence Support to Information Operations*, Rand Corporation 2005, slide 10.

¹⁵ *Ibid*, slide 11.

This author's study of intelligence doctrine both through service as an Intelligence Officer and as research for this monograph has lead this author to adding one more reason why intelligence continually fails to provide adequate support for IO. Intelligence doctrine, like other doctrine, views IO as a totally separate function. The revised FM 2-0 and other draft intelligence manuals present IO as a totally separate and distinct function that a commander must use, but not necessarily integrating that function across his operations. Manuals may say "integrate" but no manual provides clear guidance on how intelligence supports integrated IO.

Assessment

While IPB was the key to understanding the information environment, assessment was the key for understanding what effect the unit's operations had on the information environment. There were two issues with conducting accurate and meaningful assessments. First, doctrine provided little guidance on how to conduct assessments. Second, assessments have traditionally been associated with Battle Damage Assessment, in other words the lethal targeting process. Lethal targeting tied the assessment process to the Air Tasking Order (ATO) cycle. This was especially at the operational level. There was no provision for assessing targets several days or even weeks after delivering an ordnance (or message) to a target. Finally, the non-intelligence reporting that would aid the G2 in providing an accurate assessment was not readily available to the G2 for analysis.

Because there was not a single Army doctrinal manual devoted to conducting assessments, this author had to review roughly six different manuals to cover the full spectrum of Army assessment doctrine. A reading of IO doctrine, intelligence doctrine and targeting doctrine led this author to conclude that doctrine required three steps in conducting assessment. The first step was to develop accurate measures of effectiveness (MOE) (Did the target react in a way we wanted it to? Were the number of systems destroyed (or damaged) enough to meet the commander's requirements)? The second step was to develop a collection plan that tracked the

target set and was capable of determining whether the target had been affected by the delivery platform. (Delivery platform was not limited to kinetic systems, but could be PSYOP, CA, leader engagement, etc). The third step was to develop measures of performance (MOP) to assess the effectiveness of the deliver asset (Did the delivery platform do what it was supposed to do?).

All the various doctrinal manuals implied that the assessment process was a joint function between operators (IO, PSYOP, fires, etc) and intelligence analysts. Working together, they developed MOE that were measurable and accurate. It is with these MOE that the G2 would develop a collection plan to identify changes in the environment. Together, the operators and the G2 determined if the objectives had been met by a particular time. This deadline for achieving the desired effect on the target drove when collection assets needed to collect on the target by when analysts had to determine if the effect had been achieved. The third assessment step, developing MOPs, did not require intelligence input. This was purely an operator function. In it, the operator determined whether the delivery mechanism delivered its payload/message to the intended target at the right location at the right time.

Current doctrine provided no guidance on developing MOE and there was little training available on developing MOE, so it should not be a surprise that of all steps to the assessment process, developing MOE would be the one most often performed poorly. The tendency became to track MOP as MOE. This was based on the assumption that, if a delivery platform delivered a message, then the target received the message, it understood the message and acted according to the message. Furthermore, if the MOE were not measurable, then collection assets could not identify the MOE was occurring and there was no feedback. The same is true if the timing for observation of the MOE was incorrect. In this case, however, collection assets would not be present to observe the MOE. The end result was the same; there was no feedback to determine if the ordnance/message had the desired effect on the target.

Because current assessment practice had been associated with lethal targeting, the assessment cycle became tied to the ATO cycle. The consequence of linking assessment to the

ATO cycle did was an expectation for near instantaneous feedback. IO was generally incapable of producing instant results and generating meaningful instant feedback. At the tactical level, it could take days or even weeks for the results to become evident. At the operational level, that time frame could extend to months or even years. IO assessment tied directly to the ATO cycle cannot work, a more reasonable assessment timeline needed to be developed.

So far in the discussion of intelligence support to IO, this monograph has discussed the inadequacy of the intelligence doctrine, specifically IPB doctrine to help the commander visualize the information environment. This monograph has also examined the inability of intelligence to provide meaningful assessment of the commander's operations on the information environment. This item of intelligence support to IO is the resourcing requirement to provide proper intelligence support to IO.

Intelligence Resourcing

The lack of solid doctrine was not the only issue intelligence faced when it came to supporting IO. There were also resourcing issues that hindered effecting intelligence support to IO. There were three areas that typical did not have enough resources. First, there were not enough trained analysts to deal with the multiple reports and reporting formats that IO could generate. Much of the reporting generated by IO did not fall neatly into the United States Message Text Format (USMTF). This required analysts to read each CA, PSYOP, or patrol report individually. This placed a heavy burden on the ACE and the G2. Now not only did they need to sort through the reports generated from their own sensors, they also had to read the reports the CA and PSYOP teams generated. There simply were not enough trained analysts to do this efficiently. Second, the data processing systems between IO and intelligence were incompatible. IO reports were free text reports and were unable to parse into an ASAS database. Analysts often used a separate non-standard database or spreadsheet in order to track the IO reporting. This meant the analyst now worked two or more different computers to do his job.

Lack of standardized databases also made it difficult for the G2 and the IO section to share information. As a rule, neither the G2 nor the IO section collaborated to make standard overlays for their maps and other presentations. There was no standard tracking system to ensure both the G2 and the IO section viewed the same battlefield at the same time in the same manner.

One noteworthy exception to this failure of intelligence to support IO was in the First IO Command (Land). Because of its unique relationship to the Army's Intelligence and Security Command (INSCOM), the First IO Command was able to produce some fine products describing the information environments in Afghanistan and Iraq. These products were exceptional and provided units deployed to Afghanistan and Iraq with valuable contextual data. Unfortunately, these products usually lacked the detail to be practical to tactical units who often needed to know who the key communicators in a given town were, not just the key communicators for a particular region. Another issue with the First IO Command products was the difficulty units had in obtaining them and then analyzing them to see what was pertinent to their areas of responsibility. Bandwidth issues would plague the first rotations to Afghanistan and Iraq. Although there is more bandwidth available now, there is still not enough to allow unrestricted reach back capability from the field to the First IO Command.

In summary, intelligence support to IO is critical to ensuring the commander's success. For intelligence support to meet the detailed requirements to support IO, several areas must be addressed. First, intelligence doctrine must view IO as an integrated function much the same it views rivers crossings or counterfire. Second, commanders must drive the intelligence process to provide support to IO. Third, intelligence doctrine must provide more on guidance on the "how" of intelligence support. It cannot simply direct to collect, process and disseminate information. Fourth, intelligence must have the resources to support IO. These resources include collection assets capable of reporting on the information environment, data management systems that can process the various reporting formats that IO generates and trained analysts capable of providing

a detailed analysis of the reporting that various assets operating in the information environment generate.

RESOURCING IO

If IO is a critical task that units must conduct, and it must be integrated across all the BOS elements and executed across the full spectrum of combat operations, then it must have adequate resources to accomplish its mission. Examining how units resourced IO would indicate the importance commanders placed on IO. In many cases, Army doctrine, overall Army resourcing capabilities, and higher headquarters requirements would limit what resources commanders could dedicate to supporting IO. In many instances, commanders had to divert assets from one mission requirement to support the IO requirement. This chapter will examine how the Army and ultimately its commanders have chosen to resource IO.

This chapter will examine the resourcing issues the Army has with IO. Through an examination of the manpower, equipment and training provided to ensure IO is integrated into operations, this paper will highlight the shortages the Army must address to give IO a better chance of success. Next, this chapter will identify the resources that were available to the commanders participating in OEF and OIF. The chapter presents a brief discussion of the overall operational/strategic situation in Afghanistan and Iraq to better place the resource allocations in context. Within each operation, this chapter highlights what IO resources were available at the major points of the campaigns. For the sake of clarity and simplicity, this monograph will only discuss to Division level resolution what resources were available in Afghanistan and Iraq. Below division level, task organizations changed so often that tracking teams and detachments would be impossible. To aid the reader, Appendix C provides a brief description of the organization of the IO units as well as the unclassified capabilities of the major systems they have.

Manpower

Since the inception of the IO Career Field (FA 30) in 1999, the career field has been continually undermanned. Between FY 05 and FY13, the IO requirements jumped from 193

required field grade officers to 305 officers. The large increase in requirements is due to the Army's transformation. Prior to transformation, IO officer assignments were limited primarily to Corps and higher with a couple Divisions being authorized IO cells. As a result of transformation, every maneuver brigade in the Army received an IO officer. Other IO positions were also in the several fires brigades, each corps, the numbered armies, the First IO Command, most unified and sub-unified commands.

Currently, the Army is short almost forty percent of the required IO officers. The US Army IO Proponent (USAIOP) has developed an active recruiting program to meet personnel requirements, but it will still take until FY 2013 to fill all the manning requirements. The graph below depicts current and projected IO requirements and fill according the USAIOP.

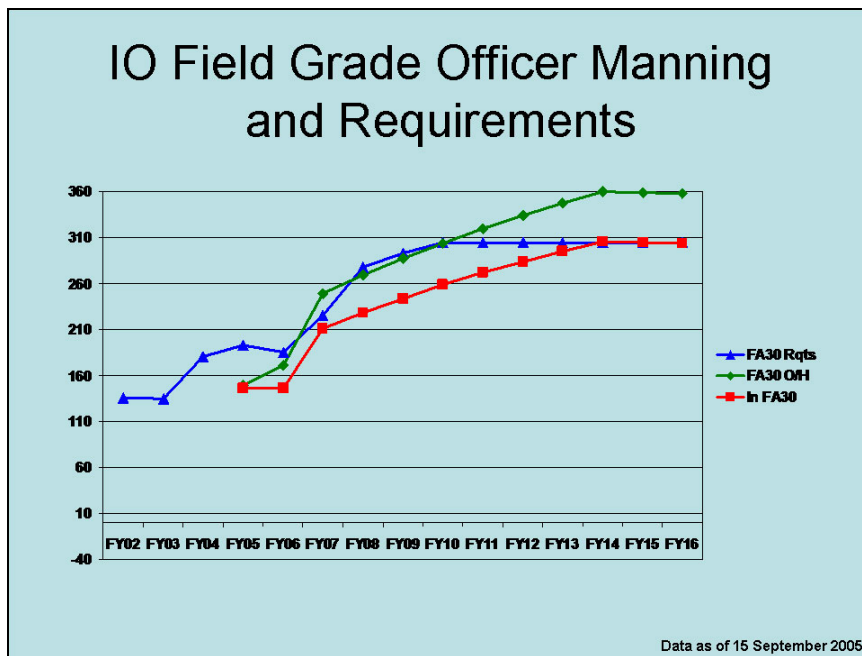

Table 2: IO Field Grade Manning Requirements¹⁶

While Table 2 presented an accurate timeline, the USAIOP based the numbers on meeting their accession goals. This year, the USAIOP was unable to meet that goal. The other problem with the USAIOP's recruiting efforts is that there has been no attempt to recruit combat

¹⁶ Kenneth Krumm, *FA-30 Man the Force: Senior Leader Update*, United States Army Information Operations Information Operations Proponent, 4 January 2006, slide 5.

arms officers. In the FY 2006 accession board, well over half of the potential IO officers were from non-combat arms field, most of whom were from the Combat Service Support branches. While these officers may display exceptional technical competence, their lack of experience with maneuver operations could place them at a disadvantage in communicating with Combat Arms officers. This could potentially cause additional issues with integrating IO.

To assist in the acknowledged, but unresourced requirement for units in the operational army, the First IO Command (known as Land Information Warfare Activity, or LIWA, prior to 2003) developed a plan to provide short-term assistance to units who would deploy. This assistance came in the form of Field Support Teams (FST). The FST would usually deploy to meet the unit in its deployed location, occasionally; the FST would participate in pre-deployment training with the unit the FST would support. FSTs would rarely remain with a unit more than a year. If operations lasted longer than a year, then the FSTs would rotate out of theater and a new FST would replace them. The First IO Command originally intended for FSTs to support corps and higher headquarters, but on occasion would support divisions. The FST brought capabilities to the unit that the unit could never hope to match, a reach back to national databases. These databases would provide a more detailed analysis of the information environment than the unit could accomplish on its own. This pattern of deploying FSTs still continued in support of OEF and OIF.

By 11 September 2001, the Army had only two Divisions with an authorization for IO Officers, the Fourth Infantry Division and the First Cavalry Division, both at Fort Hood, TX. The remaining IO Officers were at corps and higher headquarters, but many of those headquarters remained undermanned. None of the units that would initially participate in OEF had dedicated IO support. This support would come from the First IO Command. This monograph will address IO resourcing for both OEF and OIF later in this chapter.

Although the TOEs developed by TF Modularity did much to set the conditions for the growth of the FA 30 career field, they did leave some items that still need to be addressed. First,

the organizations were officer heavy; this was because there was no enlisted MOS for IO. There were MOSs for PSYOP, CA, PA but none for IO in general nor for EW, OPSEC or MILDEC. There were NCO positions on the IO section TOEs, but these NCOs were combat arms and the soldiers who filled those slots probably did not have any background in IO when they arrive in the section. The lack of prior IO training for the NCOs left the training of those NCOs to ensure they understood IO squarely on the unit.

Two key positions on the TOEs that were filled less than optimally were the positions of the EW officer and the deception officer. Current unit TOEs required EW officers at the brigade level and deception officers at the division and higher level. While personnel issues may have been the driving factor, having no EW officer at the division seriously hampered the division's ability to synchronize all aspects of IO in its battle space. Additionally, according to the latest TOEs, both of these positions were filled by MI officers. These positions were probably filled with MI officers because, MI officers coded 35G (SIGINT) received training in radio wave propagation and SIGINT and would in theory make adequate EW officers, most MI officers receive some training on the capabilities of collection assets of potential adversaries and would therefore make adequate deception officers. Neither of these officers received training that was specific to perform the duties of an EW officer or as a deception planning officer, and the Army did not have a training program geared toward either of these job requirements. MI officers also received little training on IO and how their specialties would compliment the other elements of IO and assist the commander in achieving his overall objectives.

Equipment

Even though the TOEs developed by TF Modularity provided the IO section with basic equipment to be moderately functional, there were still key pieces of equipment missing. The most critical shortage was in automated data processing (ADP) equipment. There was no provision in the TOEs that provided a system the IO section could use receive reporting, process

the reporting, analyze the reporting and make assessments as to what is happening in the information environment.

There was ADP available when TF Modularity developed the TOEs, but these systems were not compatible with other Army ADP systems. The Joint Information Operations Center (JIOC) proffered the Information Operations Navigator (ION), which was perhaps the best software for planning and monitoring the execution of IO operations. But even this software was not fully compatible with the Army's systems.¹⁷ There was no satisfactory interface with any of the Army Battle Command Systems (ABCS), there was also no interface with the Global Command and Control System (GCCS). Furthermore, the Army's planning software build around Command Post of the Future (CPOF) was not designed to allow input from IO and other staff sections that did not conform with a strict 24 hour planning/execution (or ATO) timeline. Either there had to be new IO software that was compatible with current ABCS and planning systems or current ABCS systems had to build IO functionality.

The army also lacks EA assets. Since the retirement of the AN/TLQ-17 and EH-60 Quickfix tactical jammers, the Army has not had any tactical jamming capability. The inability for Army units to provide short range EA in support of Army operations requires the Army to be totally reliant upon EA assets from the Air Force or the Navy. While these airborne platforms are extremely capable, ground units attempting to utilize these assets soon discover the ground priorities often conflict airborne priorities. In practical terms this means if the Air Force or the Navy was not planning an EA mission at the same time and roughly the same area as the Army, then the Army conducted its operations without EA support. In the late 1990s and early 2000s there was a discussion about adding an EA capability to a UAV or the AN/MLQ-40 PROPHET SIGINT collection system, but to date neither system currently exists. For the system to be

¹⁷ ION was undergoing modifications to a more capable system and more compatible with Joint ADP systems at the time this monograph was being written. This author is unaware of the requirements currently leveled on the contractor, but recommends that one of the requirements be that it be fully compatible with Army tactical battle tracking and planning software.

effective, the platform should include many of the same capabilities found on the EA-6B or the EC-130H and have both aerial and ground-based emitters.

Training

The Army has been struggling since the 1990s on how to train commanders and their staffs on integrating IO. Training IO officers was not enough, the Army also needed to train unit staffs and commanders on how to implement IO. Current training programs were inadequate to train commanders and their staffs on properly integrating IO. Although each of the Combat Maneuver Training Centers (CMTCs) has made improvements on training IO, the artificialities of those exercises tended to give commanders two false impressions about IO. First, the CMTCs created an expectation that IO could produce relatively quick results. The commander did not have to wait six weeks or longer to achieve some kind of effect, mainly because the timeframe of the exercises did not permit long range IO planning. Second, the CMTCs did not penalize commanders for failing to integrate IO into their operations. During the IO Symposium of 15-16 December 2005 at Fort Leavenworth, Kansas, one of the participants remarked candidly, “If you tell a commander he can win without integrating IO, then he won’t bother to integrate IO.” Given that unit training could not easily support IO integration, commanders and their staffs needed to receive more in depth training on IO as part of their professional development.

Non-IO officers needed to receive more IO training during their branch courses, the Intermediate Leader Education (ILE), the Army War College and other Army sponsored training. This training could no longer be just a review of the principles of IO, but needed to focus on how to integrate IO. Practical Exercises in Army courses needed to give more hands on experience with integrating IO. This training also needed to include instruction on how information affects the operational environment. When commanders understood how operations influenced the information environment and the information environment influenced the operational

environment, then they would have a better understanding as to how to use operations to shape both environments.

In addition to more training on IO, commanders needed more cultural awareness training. Prior to OEF and OIF cultural training usually consisted of general cultural guidelines, usually along the lines of cultural do's and don'ts. This rudimentary does nothing to advance the commander's knowledge of the environment in which he is operating. Commanders needed more detailed knowledge the aspect of religion, family structures, political structures, tribal issues, demographics, cultural norms and mores and culturally based personal information processing methods to understand what effect his operations would have in a given area.¹⁸

IO Officers needed more in-depth, more focused training. As of this writing, the FA 30 qualification course was expanding to nine weeks to include more detail and in depth instruction in implementing IO. Instead of providing an overview of the elements of IO, the course needed to provide more details on each of the elements, then integrating those elements with one another, and finally on integrating IO with other functions a unit would perform when deployed. While the IO Officer did not need to be an expert on all the elements of IO, he did need a working knowledge of each of the elements so understand clearly their capabilities and limitations.

Besides general IO training, IO officers also needed specialty training on each other core elements of IO. If this training were not available during the qualification course, then IO officers needed to attend either, an Army school, another service school or a joint school that focused on that element. Three courses in particular that the officer could benefit from are, OPSEC, EW and MILDEC. (Perhaps the deception and EW positions on the staff could be coded for officers who have attended training specific to those areas). While IO officers did not need to attend the PSYOP, PA or CA courses, these officers needed more exposure to those areas.

¹⁸ Michael McFate, "The Military Utility of Understanding Adversary Culture," *Joint Forces Quarterly* (July 2005), 43 – 44.

All IO officers could also benefit from instruction by civilian public relations firms, either as training with industry, or a block of instruction during the IO qualification course. This would give them insight into how the concept of branding and corporate images was used to change the perceptions, attitudes and actions of the typical American consumer. During a visit to Barkley Evergreen and Partners, the largest public relations firm in Kansas City, this author learned that public relations firms used a similar planning structure as IO planners. Public relations firms also integrated information and actions to change the perception of a company, product, or brand. This was in essence the same technique commanders should use to manage perceptions on the battlefield. Exposure to civilian techniques of marketing and public relations could help IO officers to broaden their skill sets especially in areas related to influencing peoples' perceptions.

So far, this monograph has only addressed the resourcing issues the Army faced. The issues the Army faced with resourcing would come to forefront during OEF and OIF. Both operations would face resourcing challenges that would threaten the commanders' success on the battlefield. While the operations in Afghanistan and Iraq were unique, the commanders in each theater developed similar solutions to the problems they faced. In many cases, the commanders in Iraq copied, to some degree, those actions that were successful in Afghanistan.

Operation Enduring Freedom

On 7 October 2001, the United States and its allies initiated operations in Afghanistan to “disrupt the use of Afghanistan as a terrorist base of operations, and to attack the military capability of the Taliban regime.”¹⁹ The attacks on the Taliban and Al Qaeda were a response to the 11 September 2001 attacks that damaged the Pentagon and destroyed the World Trade Center. The US response to the attacks would be unlike previous responses to Taliban attacks on US

¹⁹ President George W. Bush, “Address to the Nation,.” (7 October 2001), Available from <http://www.whitehouse.gov/news/releases/2001/10/20011007-8.html>; Internet.

targets. This time, the nation stood behind the president as he sought to not only exact revenge on Al Qaeda, but also to destroy the regime that provided Al Qaeda its base of support. By 2005, over 30 different nations had participated in operations in Afghanistan, only a handful of nations actually participated in combat operations, but the remaining nations provided resources to help rebuild Afghanistan.

The tasks of defeating Al Qaeda in Afghanistan and removing the Taliban from power were quickly accomplished. It took the Coalition Forces just 70 days from the date of the first attacks on Taliban air defense and C2 nodes until Hamid Karzai took the oath to be the interim president of Afghanistan. US and Coalition Special Forces (SF) working with Afghan tribes would conduct the bulk of the operations against Al Qaeda and their Taliban supporters. Coalition and US Air Force and Navy aircraft would provide the critical force the Northern Alliance forces needed to defeat the Taliban.

To defeat the Taliban and Al Qaeda, CENTCOM had limited but effective resources at his disposal. These resources included SF teams on the ground working directly with Afghan resistance forces to provide targeting information to Coalition attack aircraft. These SF teams, working with CIA teams also had the mission to convince neutral Afghan warlords to join the fight against the Taliban. In the air CENTCOM was able to use the EC-130H Commando Compass and the EA-6B Prowler to disrupt Taliban and Al Qaeda communications links and air defense networks. To influence the bulk of the Afghan populace, CENTCOM used the Joint Psychological Operations Task Force (JPOTF) with an element in Qatar to develop various PSYOP products designed to win the support of the Afghan people. The JPOTF's assets included the EC-130J Commando Solo and SOMS-B to broadcast messages on Afghan radio and television frequencies. The JPOTF would also create posters, leaflets and handbills to be given to the Afghans to provide them information.

In December 2001, efforts would shift from defeating the Taliban to helping establish a viable long-term government in Afghanistan. It was at this point that US maneuver forces began

to deploy to Afghanistan. These forces formed around the 10th Mountain Division would form Combined Joint Task Force (CJTF)-180 (later renamed to CJTF-76). In June 2002, the Combined Forces Command – Afghanistan (CFC-A) would assume responsibility from the Combined Force Land Component Command (CFLCC, also known as Third Army) forward headquarters for operations in Afghanistan. The CFC-A focused on country wide issues, including coordination with the UN Mandated International Security Assistance Force (ISAF) while a separate force the CJTF-76 would focus on day to day operations for most of Southern Afghanistan outside of Kabul, until ISAF was able to assume responsibility for specific areas. While CFC-A used a Joint Manning Document (JMD) to develop its entire structure, CJTF-76 used a division Modified Table of Organization and Equipment (MTOE) augmented through a JMD to develop its structure. The JMD specified the rank and specialty required for each billet. In some cases the billet required a six-month fill, in other cases, the billet required a twelve month fill.

Over the course of OEF, the structure would remain essentially the same, with only minor changes usually driven by unit peculiarities or available forces and personnel. In general, the IO assets available to the CFC-A included access to theater assets such as the EA-6B Prowler and EC-130H Compass Call for EA. As the improvised explosive device (IED) threat became more intense, ground-based jammers helped protect the convoys and installations used by CFC-A from the remote controlled IED (RCIED) threat. For PSYOP support, the CFC-A used EC-130C or EC-130J and a Special Operations Media System – B (SOMS-B) for PSYOP broadcast support, and after 2003, a PSYOP Support Element (PSE) for PSYOP product development support. One shortfall that would plague OEF was the inability to mass produce PSYOP products in Afghanistan. All PSYOP product production occurred either in Qatar, Kuwait or Fort Bragg. This caused there to be a two to four week process for the production of new PSYOP products. The assets available to the CJTF allowed the CJTF to reach target audiences within its area of operations and provide support to achieve strategic and operational IO objectives. Those assets

included a tactical PSYOP company (TPC) and combat camera (COMCAM) section. Figures 4 through 8 depict the composition of the forces deploying to OEF from October 2001 until the present time. The data concerning IO force structure is from the USAIOP at Fort Leavenworth, KS.

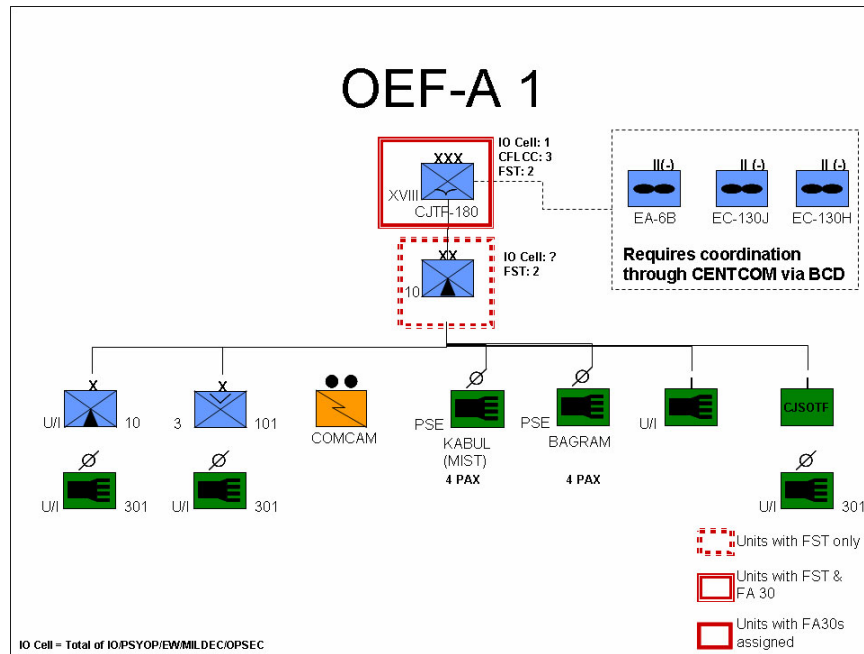

Figure 4: OEF-1²⁰

USCENTCOM initially used the Third US Army (also known as CFLCC) to provide a higher headquarters for the 10th Mountain Division. By June 2002, the XVIII Airborne Corps replaced CFLCC as the higher headquarters to become CJTF-180. Because the unit MOTEs did not support an IO cell in 2001, any IO support came through FSTs and other augmentation provided to the units deploying to Afghanistan. By late 2002, the military situation in Afghanistan changed as the UN, with NATO taking the lead, deployed ISAF to Afghanistan. It was also at this time, that CFC-A assumed responsibility for the Afghan area of operations and CJTF-180 became a subordinate command to CFC-A.

²⁰ Global Security Website, Available from http://www.globalsecurity.org/military/ops/oef_orbat.htm; Internet

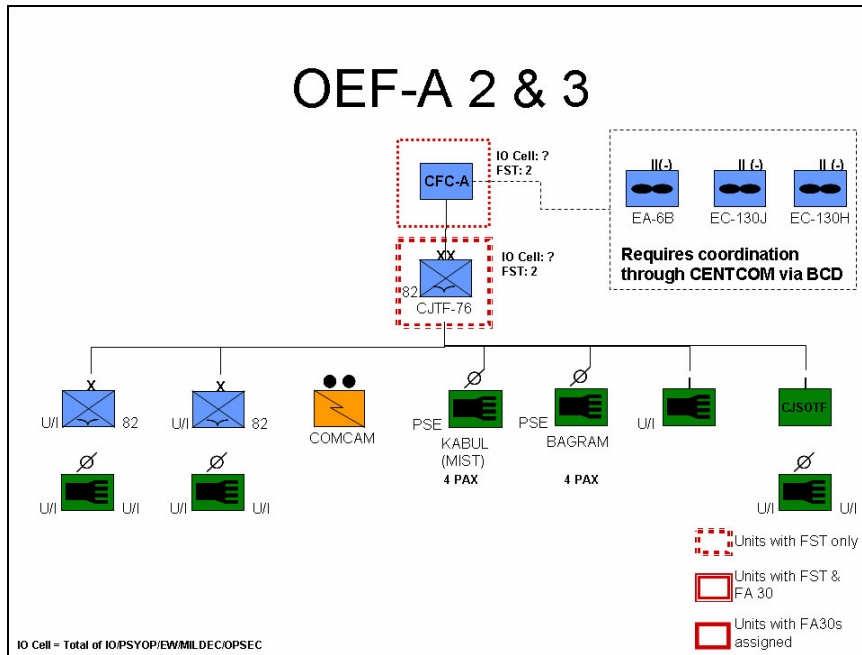

Figure 5: OEF-2 & 3²¹

In October 2002, the 82nd Airborne Division would deploy with an authorization for an IO officer on its MTOE, but due to shortages of IO officers in the Army’s force pool, would not receive an IO officer and would still be dependant upon 1st IO Command FSTs for its IO support. CFC-A through the JMD would receive IO officers tasked to support CFC-A. Ordinarily, these officers came from the Reserve Component IO Commands either in Texas, Washington or Vermont. By the end of these rotations, the Army began to address some of the resource shortfalls, including the PSYOP product production. These changes would begin to take shape during OEF-4.

²¹ Ibid.

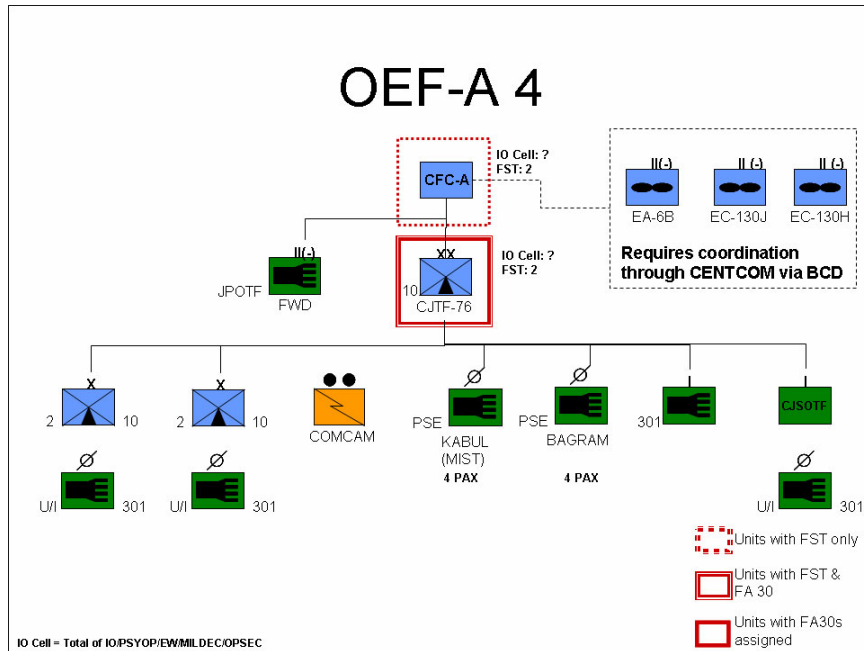

Figure 6: OEF-4²²

By the time the 10th Mountain Division deployed to Afghanistan in 2003, the Division had authorizations up to three IO officers (2 Majors and 1 Captain). The division still depended on JMD authorizations to complete its IO cell. At the end of its rotation, the Division would begin its conversion to modularity at which point it would be authorized 11 IO Officers at the Division Headquarters.

²² Ibid.

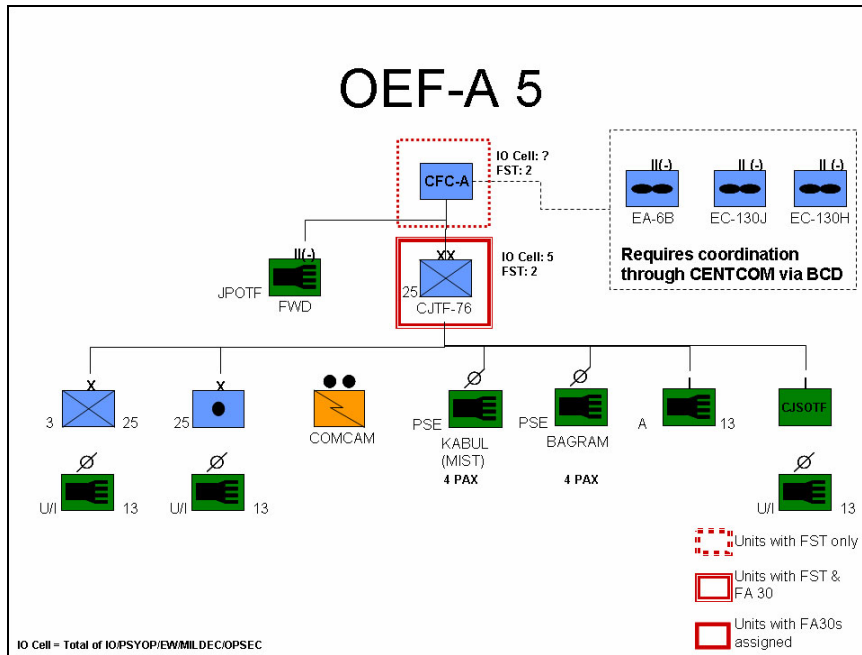

Figure 7: OEF-5

OEF-5 was the first time the CJTF deployed with MTOE authorized IO personnel. Even though the 25th Infantry Division had the IO personnel authorizations, the Army’s personnel shortages in IO officers prevented the division from deploying with a complete IO cell. The JMD authorized some personnel to fill the requirements the division could not, but the various US armed services were unable to fill all the required positions on the JMD. One such failure to fill the JMD requirement was the lack of an EW officer from the Navy, so the CJTF filled the position with a Field Artillery warrant officer from the Division Fire Support Element.²³

²³ Chip Bircher, interview by author, Leavenworth, Ks, 23 January 2006.

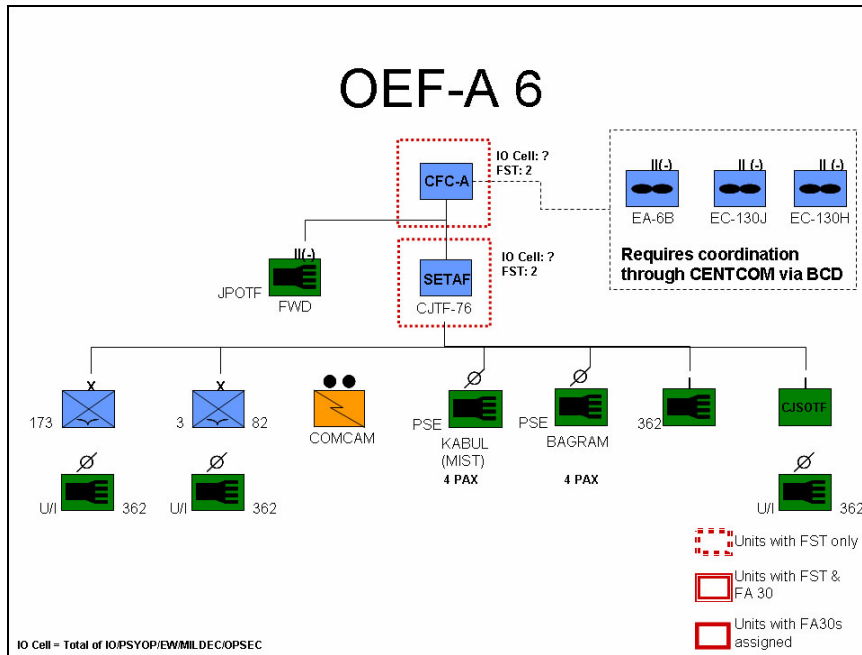

Figure 8: OEF-6²⁴

The US Southern European Task Force (SETAF) would be the first organization to have Lieutenant Colonels authorized to be in the IO cell. Because the MTOE IO cells were not robust, the SETAF would depend on the JMD to fill its IO cell requirements.

As CFC-A and CJF-76 became more mature organizations, they were able to more adequately determine their IO resource requirements. Lessons learned between October 2001 and October 2005, when the latest OEF rotation occurred, helped shape the resourcing provided to operations in Afghanistan. Even though the Army attempted to address resource shortfalls, there were still issues that for a variety of reasons, failed to be resolved. First, there was a lack of translator support, not just for the IO cell, but for all the forces in theater. There simply were not enough linguists available in the Department of Defense to meet all the language requirements. Second, PSYOP support was still too slow to provide timely support to the commander's information requirements. Third, even though IO cells were becoming more robust, there were still not enough IO officers in country. Again this problem was an Army-wide issue that would

²⁴ *Global Security* Website, Available from http://www.globalsecurity.org/military/ops/oef_orbat.htm; Internet.

only be resolved once there were enough IO officers to support all the Army's requirements. Finally, although not an issue yet, the decision to limit the mobilization time for reserve component soldiers has begun to create a situation where PSYOP organizations were deploying as ad hoc organizations rather than coherent units that had trained and prepared for the deployment to Afghanistan. The units may have deployed with all the required personnel, but they did not deploy with soldiers from the same unit. Instead these units were composed of soldiers from multiple PSYOP units across the country who had neither trained nor worked together for any significant period of time prior to the deployment to Afghanistan. These same issues would confront the Army in supporting OIF. How the Army resourced OIF is the subject of the next section.

Operation Iraqi Freedom

After over a year of planning and diplomatic wrangling in the United Nations, the United States and coalition forces attacked Iraq. Although the debating was often intense, there was no consensus in the United Nations Security Council as to whether or not force was authorized, the United States and the "Coalition of the Willing" pressed on for operations against Iraq. On 19 March 2003, intelligence reports from Iraq indicated that Saddam Hussein and his sons Uday and Qusay were gathered in a farm outside Baghdad. Based on this information, President George W. Bush authorized an air attack on the farm to decapitate the Iraqi leadership and perhaps hasten the end of the war. Once the attack was over and the aircraft were out of Iraqi airspace, President Bush announced, "coalition forces are in the early stages of military operations to disarm Iraq, to free its people and to defend the world from grave danger."²⁵

Operation IRAQI FREEDOM was the first pre-emptive war of the Global War on Terror. When Operations began on 19 March, between one-third and one-half of the Army's combat

²⁵ US President George W. Bush, "Address to the Nation," (19 March 2003), Available from <http://www.whitehouse.gov/news/releases/2003/03/20030319-17.html>; Internet.

power was either in theater or would be in theater within 30 days. The stated goal of OIF was to force Iraqi compliance with UN resolutions regarding weapons of mass destruction (WMD) and to remove Saddam Hussein’s regime from power. Figure 9 shows the forces available to CFLCC until shortly after President Bush announced the end of major combat operations in Iraq.

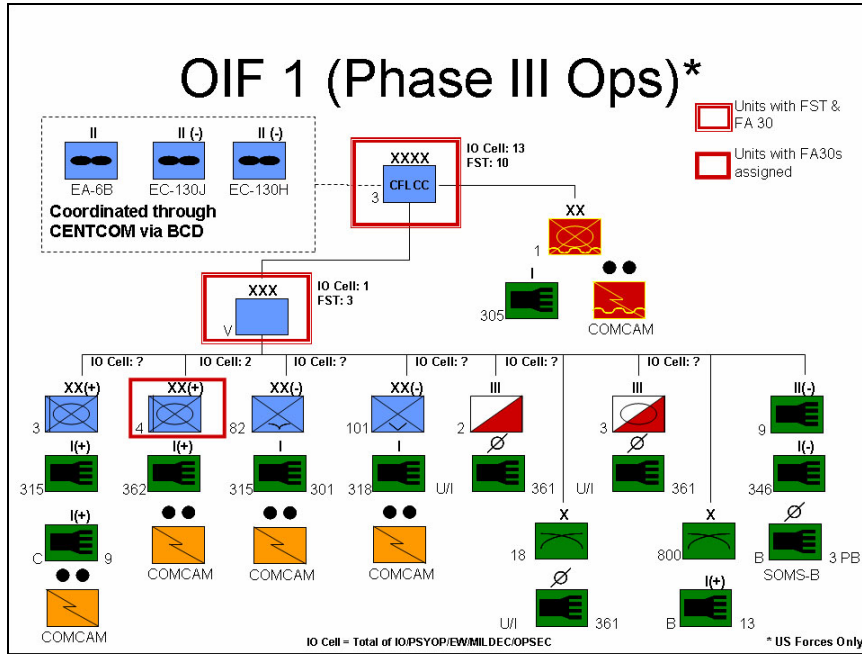

Figure 9: OIF-1 Major Combat Operations²⁶

At the beginning of Phase III (Major Combat Operations) the 4th Infantry Division and the 3rd Armored Cavalry Regiment were still deploying to Iraq and completed their deployments by the time the president announced the end of major combat operations. In hindsight, although this force was sufficient for removing Saddam’s regime, it proved to be insufficient for setting proper conditions for Phase IV (Stability Operations).

USCENTCOM’s IO assets were primarily for shaping the overall theater’s information environment. This required primarily airborne platforms. Airborne Information Operations resources during the fight to Baghdad included the EC-130C/J Commando Solo based in Qatar or Kuwait. The EC-130J broadcast not only on civilian frequencies, but also broadcast on Iraqi

²⁶ Greg Fontenot, E.J. Degan, David Tohm, *On Point: The United States Army in Operation Iraqi Freedom* (Annapolis: Naval Press Institute, 2005), 441-495.

military frequencies to influence the soldier to capitulate and not fight Coalition Forces advancing into Iraq. The EC-130H Compass Call and the EA-6B Prowler conducted EA on the Iraqi C2, fire support and air defense networks. Depending on where these three aircraft flew, they could provide IO support to reach over ninety percent of the Iraqi military and civilian populace. All these aircraft (Commando Solo, Compass Call and Prowler) were available for CFLCC to request through the normal targeting and apportionment process at USCENTCOM.

In terms of PSYOP support, CFLCC had direct access to the JPOTF to develop PSYOP products for the theater. Although the JPOTF remained in Qatar, it provided a forward element to CFLCC to ensure the ground attack had the PSYOP product development and product support it required. While the JPOTF could produce products locally, it still had to get the paper PSYOP products to the delivery mechanisms for dissemination. This was difficult in that delivery platforms flew from bases in the United States, Europe, the Middle East and Diego Garcia. For delivery of CFLCC's printed PSYOP products, the CFLCC IO cell was at the mercy of the apportionment process at USCENTCOM. Leaflet bombs were competing with kinetic target missions by the Coalition Air Forces. Once maneuver forces secured Baghdad, the JPOTF moved a SOMS-B into the Iraqi theater to supplement Coalition broadcasts from the Commando Solo, but production of paper products remained in Kuwait or the United States.

The two major US commands of CFLCC, V Corps and 1MEF, could request support through CFLCC, but had no ability to affect their battles pace directly. While V Corps did have the 9 PSYOP Battalion, it could not mass produce PSYOP products nor could it directly control PSYOP broadcasting from the Commando Solo or SOMS-B because these systems typically receive their programming and broadcasting instructions from the JPOTF. Because of a combination of CFLCC targeting to isolate the regime from the Iraqi populace and widespread looting following the collapse of the regime, neither V Corps nor 1MEF were able to co-opt Iraqi television or radio because the media outlets no longer existed as viable transmission points. The

inability to use broadcast media to reach the Iraqi populace would remain an issue for the remainder of 2003.

Every US Division that crossed into Iraq, had at its disposal tactical PSYOP units, usually a TPC, up to four Combat Camera Teams, and a Mobile Public Affairs Detachment (MPAD). The TPCs even though they had a limited production capability, they were limited in their ability to create products that better supported their Division commanders because the PSYOP product approval process required that the Commander of USCENTCOM approve newly created PSYOP products before they could be used. This left the TPCs with a limited supply of generic products that while supporting the USCENTCOM and CFLCC Commanders did little to assist the TPCs in reaching their local audiences with pertinent information.

The Divisions also lacked any EA capability. As part of the Army's Electronic Warfare modernization program, the Army removed the AN/TLQ-17 TRAFFICJAM and EH-60 QUICKFIX from the active component Army inventory. Variations of the PROPHET would replace both systems, but not before Fiscal Year (FY) 2007. They could request EA assets through the targeting process, but the ground fight progressed too rapidly for the initial units to be able to predict where they would be in 72 hours. By the time the 4ID occupied Tikrit, the Iraqi military was no longer a coherent military against which to use EA assets and the developing insurgency used other, non-radio communications (primarily signal flares, light signals, smoke, and couriers) methods, to communicate. Even as the insurgents developed a more robust communication system based on portable radios and cell phones, the Divisions never obtained a method to degrade those communications methods.

The actual combat to remove Saddam's regime from power would only last three weeks. Between 19 March and 9 April, the largest Army in the Middle East would crumble before a force less than half its size. On 1 May, President Bush announced the end of major hostilities in Iraq. The effort to rebuild had begun and the United States started to settle in for a protracted engagement in Iraq. The long-term use of military forces was contrary to the wishes of the

president, but the situation in Iraq demanded a strong US presence to keep the country from disintegrating. For the remainder of 2003 and until the 28 June 2004, when the Coalition Provisional Authority (CPA) returned sovereignty of Iraq to an Iraqi government, Coalition forces focused on defeating insurgent forces made up of former military officers, disgruntled members of the former regime, disgruntled Sunni Arabs and foreign fighters, many of whom has some allegiance to Al Qaeda.

The arrival of the CPA marked the end of CFLCC's mission in Iraq. The V Corps was renamed to CJTF-7 and assumed responsibility for military operations in Iraq and CFLCC redeployed most of its personnel and assets back to the US. Unfortunately for CJTF-7, the IO assets supporting CFLCC redeployed when CFLCC redeployed. Significantly, the JPOTF no longer supported Iraq from a forward command post; all support would come from Fort Bragg. (This repeated the mistake of not having a forward JPOTF with production capability supporting Afghanistan). The JPOTF support from Fort Bragg would continue until late 2003 when the JPOTF deployed back to the Iraqi theater. What this meant in practical terms for the CJTF-7 was that it could not produce PSYOP products locally and operational level PSYOP became irrelevant to OIF as tactical units leaned on their assigned PSYOP organizations for more and more support.

Assets to assist the forces who remained in country remained scarce. The Commando Solo, when it flew in the theater, flew only a few hours a day and did not reach the entire country. The SOMS-B broadcasts covered Baghdad and little more. Even though fledgling newspapers, radio stations and television stations were forming, a nation-wide Iraqi media entity was non-existent. To complicate matters, the JPOTF redeployed to Fort Bragg and was no longer supporting operations with an element in theater.²⁷ This changed in late 2003, when the JPOTF returned to Iraq. From November on strategic and operational product development with some limited production could occur in theater and was no longer dependant upon a reach back to Fort

²⁷ This author recalls a time in the May/June when he requested Commando Solo support and he was told that Commando Solo was no longer supporting operations in Iraq.

Bragg. The JPOTF forward also provided some support to operations in Afghanistan until a JPOTF forward became operational there.

Even as V Corps transitioned to become CJTF-7 they had little ability to influence the information environment for their subordinates. Because CJTF-7 had no distribution assets itself, any message CJTF-7 or even CPA wanted to get to the Iraqi populace had to be delivered by the maneuver forces on the ground. Figure 10 shows what units were available during OIF-1 Phase IV operations.

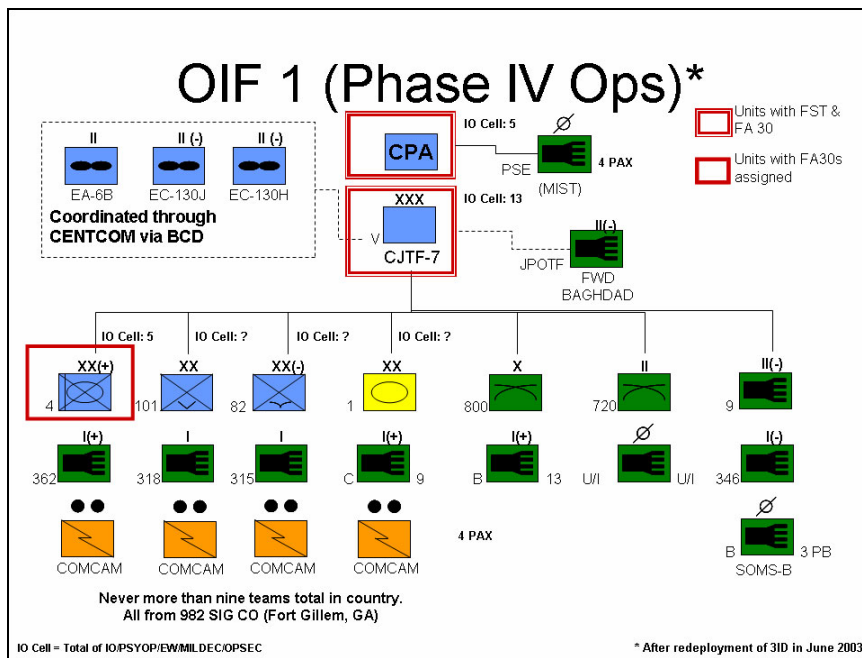

Figure 10: Post MCO, after CPA Takes Control²⁸

The IO structure to support operations in Iraq for the remainder of the time the CPA was in charge remained totally inadequate for the task. The CPA could not compete against the Iraqi rumor mill, partisan Iraqi media outlets, or even foreign satellite broadcasts such as Al Jazeera. To complicate the situation leaders in CPA had no understanding of the capabilities and limitations of the assets at its disposal.

²⁸ Global Security Website, Available from <http://www.globalsecurity.org/military/ops/global-deployments-1.htm>; Internet.

The divisions supporting CJTF-7 retained control of the PSYOP, COMCAM and MPAD assets they brought forward from Kuwait. There would be a limited turn over of COMCAM and PAO assets in the theater, but generally every unit retained what it had at the beginning of the war. COMCAM had two resourcing issues that plagued the commander to use its unique capabilities to their fullest. First, there just were not enough COMCAM teams to cover the entire country. At one point there were only 13 teams in the entire country. While COMCAM doctrine required a platoon (twelve teams) to support a Division, most divisions had the equivalent of one squad (two to three teams) to cover their operations. That was not even enough to provide a COMCAM team to every maneuver brigade in theater. The second issue for COMCAM was the lack of high-speed transmission methods. The teams initially had INMARSAT access, but this access was slow and expensive, so the teams tended not to use it. Late in 2003, three COMCAM satellite terminals arrived in Iraq. This sped up the transmission process, but required the teams to travel from where ever they were working to the closest uplink station (in the case of the 4th Infantry Division this meant the teams traveled a minimum of thirty minutes from the units they supported to the uplink station). The shortage of teams and transmission equipment prevented the COMCAM teams from covering the entire theater with timely responsive photography and video coverage. That coverage could be used by CPA in its daily press briefs or by the DoD in Washington as they prepared briefings for the press or Congress or even the White House.

A lack of media outlets in the divisions' areas limited the divisions' ability to reach their populace quickly and efficiently. The divisions set out to create media in the areas of responsibility. Their PSYOP units used PSYOP operational funds back by the divisions using the Commander's Emergency Response Program (CERP) funds for more expensive purchases. By the end of 2003, every Division had created a number of newspapers, radios and TV stations. Many of the radio and TV stations became affiliated with the Iraqi Media Network (IMN).

The IMN was a coalition sponsored network designed to get an Iraqi presence on radio and TV. The IMN achieved limited success while it was operational. One of the largest

obstacles the IMN had was overcoming the impression that IMN was a Coalition broadcast, (on an ABC news program “20/20” broadcast Dan Senor, a Coalition spokesman referred to IMN as a voice of the Coalition). The IMN also had limited ability to produce quality programming; they certainly could not produce programming that was comparable in quality to the broadcasts of Iran, Syria, or Al Jazeera. The third significant obstacle IMN faced was that it lacked satellite based transmission capability. To overcome these obstacles, the CPA hired SAIC, a contractor from the United States to build an Iraqi television and radio network. The first contractor, who has no background in broadcast media, was successful in that it helped build a network of radio and TV stations, but accomplished little else. A name change tried to break the stigma of being associated with the Coalition, the new network was called, Iraqiya, but to no avail. IMN did gain access to a satellite, but it was one of the least watched satellite transmissions in the region and most Iraqis outside of Baghdad would remain unaware of IMN on satellite.

CPA hired the Harris Corporation in late 2003 who assumed responsibility in 2004 achieved more success. New and better equipment helped the Iraqis produce quality programming; media training helped the Iraqis working with IMN understand the role of the media in a democratic society. Eventually, Iraqiya gained access to better satellite transmission capability when owners of the most popular broadcast satellite in the region agreed to allow Iraqiya to use the bandwidth that Saddam’s regime had already paid for, but was no longer using. Despite all these advances, the Coalition still could not compete with media outlets funded by competing political parties. Perhaps the greatest enemy was the Iraqi Rumor Network.

Under Saddam’s regime, the state controlled media became a propaganda outlet for the regime. The Ministry of Information determined what newspapers and magazines could print and what radio and TV stations could broadcast. Most citizens also could not own satellite television capabilities. To get around these restrictions, an underground rumor network developed. Iraqis began to believe the rumor network more than they believed the official government media outlets. Over time, the rumor network became more capable of spreading urban myth type

information than accurate information. Some of these included stories such as soldiers Night Vision Goggles possessed an “x-ray vision” capability and soldiers were using the technology to view women’s genitalia or the anti-malaria medicine taken by US troops made the soldiers less susceptible to the Iraqi which allowed them to conduct operations during the hot Iraqi summers (in fact the medicine had the opposite effect – soldiers were more susceptible to the heat and had to increase their fluid intake while on the medicine to prevent heat injuries). While those stories seem preposterous by American standards, the Iraqis readily believed them. Some of the more believable stories were that Saddam was in US custody well before December 2003 and he had secretly brokered a deal with the US that would allow him to return to power.²⁹

The increased use of RCIED prompted the creating of Task Force IED (TF IED). One result of TF IED was the ability to use EA-6B and EC-130H aircraft to disrupt the ability of the insurgents to detonate their RCIEDs. This capability remained a secret until sometime in 2005 when reports in the press indicated the US was using aircraft to jam RCIED frequencies. Other vehicle borne anti-RCIED devices and EA systems for use by tactical forces were developed, but their methods of employment are still classified and this monograph will not discuss them.

In January 2004, fresh units from across the Army began to replace units who had participated in OIF-1. The first unit to leave Iraq was the 101st Airborne Division (Air Assault) when it left Iraq in January 2004; the last unit was the 1st Armored Division which left in the summer of 2004. For the remainder of 2004 and 2005, total US strength would vary between 117,000 and 160,000 depending on rotational schedules and critical events occurring with the new Iraqi government as it followed the Transitional Administrative Law (TAL), which formed the roadmap to the December 2005 national elections for a permanent four-year parliament. Figure 11 shows the units who participated in OIF-2 from 2004 – 2005.

²⁹ Ambassador L. Paul Bremer, *My Year in Iraq: The Struggle to Build a Future of Hope* (New York: Simon and Shuster, 2005), 251.

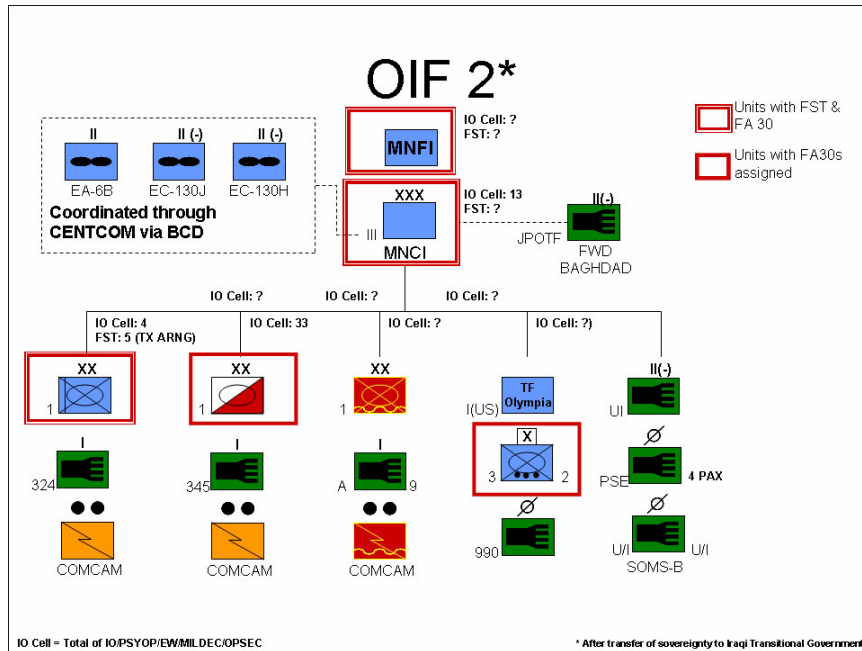

Figure 11: OIF-2³⁰

Resources continued to be scarce during this time. Along with the changing force structure came an awareness that killing the insurgents alone would not be enough to achieve victory. More commanders began to realize the importance of shaping the information environment and structured their staffs along lines that allowed them to become more aggressive in the information environment.

Once the CPA returned sovereignty to an Iraqi government, Coalition forces still focused on defeating the insurgents, whom the coalition initially labeled as Anti-Iraqi Forces. During this period, control of the military portion of OIF fell to two separate military Commands. The senior command was Multi-National Forces – Iraq (MNF-I). MNF-I’s responsibility was to concentrate on the strategic portion of the operation, including consultations with the US embassy in Baghdad and the fledgling Iraqi government. This allowed the Multi-National Corps – Iraq (MNC-I) to focus on the day to day problems of defeating the insurgency and the execution of the massive coalition rebuilding effort. MNF-I would use a JMD to determine its force requirements while

³⁰ *Global Security* Website, Available from http://www.globalsecurity.org/military/ops/iraq_orbat_050301.htm; Internet.

the MNC-I would use the Corps' MTOE to form the basis of its structure. The Corps would receive augmentation to allow it to operate in a Joint and Multi-National environment. The major events of 2004 after the CPA dismantled were the second clash in Fallujah in an attempt to defeat the insurgents who were using Fallujah as a base of operations for activity across the Sunni Triangle and the Al Anbar province; unrest in the Shiite areas of Najaf and Karbala because of provocations by Muqtada Al Sadr and his Mahdi Army. Other events included the preparation for the January 2005 elections and the creation of the Multi-National Security Transition Command – Iraq (MNSTCI). MNSTCI became the lead element in training Iraqi security forces, especially the fledgling Iraqi Army. January 2005 began the year of elections in Iraq.

The resources available to OIF-2 did not vary much from those available during OIF-1. One improvement was that each US Division now had an IO Officer to help coordinate its IO efforts.

In January 2005, as the OIF-3 rotation was beginning, the Iraqis participated in the first of three elections and referendums that would shape the new Iraqi government. The January election was to determine who would participate in the parliament which would draft the new Iraqi Constitution. Although Shiites and Kurds had great participation in this election, the Sunnis for the most part boycotted the elections, a mistake they would regret later in the year. After weeks of inter-party squabbling, the parliament finally assembled in April. Over the next few months, the parliament debated the new constitution. In October, the Iraqi people voted on whether to accept the constitution. The Sunnis were determined not to be locked out of the political process, and, this time, participated in the referendum. Although the majority of Iraqis voted for the constitution, it almost failed the referendum as over 80% of the populace in Al Anbar and Salah Ad Din (two of the three majority Sunni provinces, the other being Diyala) voted against the constitution. (Had one other province rejected the constitution the drafting process would begin again). In December 2005, the Iraqis voted for a new, permanent, parliament. This parliament would be elected for a four-year term and would be given the

ultimate responsibility of governing Iraq. It would have to deal with the remaining contentious issues that went unresolved in an effort to keep the TAL’s timeline.

During the elections, the role of MNF-I and MNC-I continued to be supporting the developing Iraqi government. Both organizations did this by helping get inform the Iraqis about the upcoming elections, and by working with the new Iraqi security forces to create a more stable environment in which elections could be held. OIF-3 would also mark the first time a reserve component unit would receive a significant portion of Iraq to provide security for. Figure 12 shows the forces available during OIF-3.

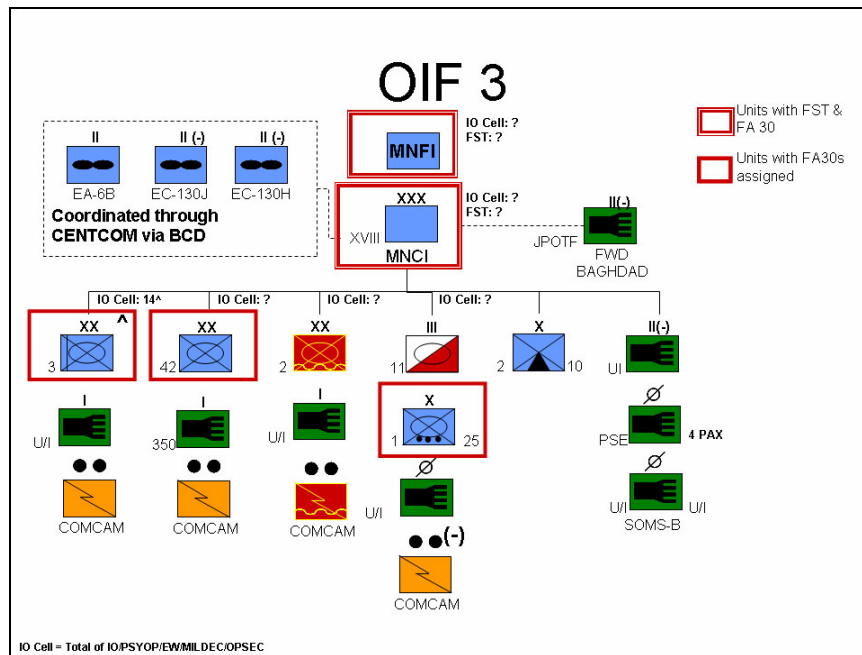

Figure 12: OIF-3³¹

The types of forces and resources available to OIF-3 changed little from OIF-2. The most significant change was the 3rd ID, which was in a partially modularized configuration. This allowed the 3rd ID to have a more robust IO cell than any division before it. This rotation also marked the first time a predominantly reserve component headquarters would be responsible for a large area of Iraq.

³¹ Ibid.

One creative attempt to resolve the shortfall in resourcing was the use of contractors to provide IO support to MNC-I and MNF-I. Given the large number of public relations firms, it was surprising that the Department of Defense selected the Lincoln Group, an organization with NO public relations experience to spearhead an effort to publicize the good news events occurring in Iraq. The Lincoln Group attempted to get US good news stories published in Iraqi media by paying Iraqi media outlets to print or distribute Coalition good news stories. Although these stories were essentially true, Lincoln group wrote the stories to make them appear as though they were generated by Iraqis themselves instead of from Coalition Forces. In doing so, they violated one of the key principles of PSYOP and PA which was to make it clear to the target audience that the articles were from Coalition Forces. The deception failed in that the articles were so poorly written that it was clear to most Iraqis the articles were from the Coalition. When the *LA Times* first published a story revealing the covert operation, the Department of Defense and MNF-I wasted time responding to charges that they had abused the press and made it simply a propaganda arm of the Coalition.

On a positive note, Al Iraqiya continued to flourish as a separate element of the Iraqi Ministry of Information serving as the Iraqi National Radio, TV and Newspaper. (See Figure 13 for a map showing the locations of Iraqi television transmitters). The Iraqi government has been using Iraqiya to reach its people. Coalition forces also sponsored programming (usually in the form of Public Service announcements) to be played on Iraqiya radio and television. Iraqiya radio was on the air in AM and FM stations and covers the entire country as well. Al Sabah, the Iraqi national newspaper is also being distributed country-wide. As of late 2004, Iraqiya television was broadcasting in 26 cities covering all of Iraq, in addition to satellite transmissions which can be seen all over the region. The network boasts the most watched evening news program in Iraq. The president of Iraq even had a weekly talk show in which he discussed events and issues currently

before the government.³² All three outlets also developed distinct websites, some of which are interactive allowing their audiences to provide feedback on programming and other issues.



Figure 13: Al Iraqiya Television Coverage³³

Resourcing IO has remained a critical issue for commanders at all levels. Shortages across the Army have caused commanders to make judgments on how to best utilize the scarce resources he has. The Army has a responsibility to provide the resources its commanders to be successful. The most significant resource shortages are personnel, equipment, and training. In the personnel arena, the Army must close the gap between requirements and available officers. There must be a concerted effort to recruit not just technically oriented officers, but officers who understand and can combat arms operations. The USAIOP must aggressively recruit some of the Army's best and brightest to serve in this career field.

³² *Al Iraqiya Website*, Available from <http://iraqmedianet.net/tv/news.htm>; Internet.

³³ *Ibid.*

As far as equipment is concerned, the Army must invest in systems that support IO planning but are compatible with the ABCS/CPOF architecture. The Army can either use a separate system that is ABCS/CPOF compatible or it can change a current ABCS platform to allow them to support IO information requirements. The Army also needs mass media systems that will allow the Army to reach civilian audiences in areas that the information infrastructure has been damaged or closed to the Army's information campaigns. While reach back has been touted as capable of supporting commanders forward, the reality is infrastructure and an inability of the rear units to get a true sense of the environment are hindering the ability of reach back to live up to its potential. The Army must invest more in a communications architecture that allows rapid transmission of information from Brigade to Divisions and higher. Additionally, there should always be an element of the CONUS based unit forward in the area of operations to help give that unit a better understanding of the operating environment. COMCAM teams must have better transmission capabilities. This is especially true for those COMCAM teams that find themselves operating in a diffused environment such as Iraq.

Training must also be more realistic and concerned with preparing commanders, staffs and IO officers for integrating IO. This means all professional military education must include more in depth instruction in IO. Unit training must provide opportunities for commanders to integrate IO and provide penalties for commanders who do not integrate IO. IO training must include in depth instruction on all the elements of IO. EW and MILDEC officers especially need specialized training in those areas, the Army should consider requiring officers who fill these billets attend either a joint course on EW or deception or an army course specifically geared to EW or deception.

INTEGRATING IO

“Understanding the effect of operations as seen through the lens of the Iraqi culture and psyche is a foremost planning consideration for every operation.”³⁴

MG Peter Chiarelli

From its conception, IO was always intended to be integrated into a unit’s operations. Because doctrine provided commanders so little guidance on how to effectively integrate IO, commanders had to figure it out for themselves. This chapter will examine how commanders serving in OEF and OIF integrated IO into their operations. As has been stated earlier, if the commander considered integrating IO into his operations important, then he expressed the importance of IO in his intent, only then, did integrating IO become important to his staff and subordinate commanders.

In examining several case studies from OEF and OIF, this chapter will examine how commander actually integrated IO. Regardless of how well commanders chose to integrate IO, several trends did manifest themselves. First, lacking doctrinal guidance on implementation, commanders developed their own organizations to help with integrating IO. Usually, the Fire Support Element (or some modification of it) became responsible for completing the integration process. Second, because doctrine lacked guidance on the IO Working Group, units implemented the IOWG differently. Those working groups that had key decision maker involvement (Deputy Commander or G3) in the working group tended to provide better recommendations to the commander for integrating IO. Third, because a single incident involving a platoon of soldiers can have strategic implications commanders tend to over control the use of IO by their subordinates. Commanders are not satisfied with setting the conditions for their subordinates’ success; they also want to limit how subordinates conduct IO. Fourth, unresponsive higher headquarters IO elements become irrelevant in the IO fight. Fifth, commanders still view IO as a

³⁴ Peter W. Chiarelli, “Winning the Peace, the Requirement for Full-Spectrum Operations,” *Military Review* (July-August 2005): 14.

function of creating conditions that would cause the international media to cover stories the commander wanted, instead of covering stories about US deaths or insurgent attacks. Sixth, commanders are having difficulty in grasping how the media operates and how to use media to their advantage. Seventh, there is no clear consensus on integrating IO and PA. Finally, IO sections are producing talking points and point papers to assist keeping everyone “on message,” even though IO doctrine does not mention producing talking points or position papers.

This chapter includes case studies from OEF and OIF in which IO integration was done well and when it was done poorly. Each of these case studies will demonstrate at least some of the trends identified earlier in this chapter. Each case study will use the following format. First, a review of the strategic and operation goals and supporting IO objectives if they were available will be discussed. Second, there will be a discussion of the following elements of IO as various commands used them: EA – primary targets and assets used to attack those targets; PSYOP – primary targets and message delivery mechanism; MILDEC – target of the deception and resources used to conduct the deception; Maneuver Forces – how maneuver forces supported IO, usually this will be in the form of leader/commander face to face engagements with key communicators; Physical Destruction – targeting C2 and communications with kinetic attacks; Media Operations – How commanders utilized the media to achieve their objectives; and finally intelligence support – how intelligence provided support to IO.

Defeating the Taliban

Operation ENDURING FREEDOM exemplified the success an operation can have when commanders have a correct understanding in the environment in which they operated and articulated clear objectives for their subordinates. The guidance from the Secretary of Defense through USCENTCOM, CFLCC and what ultimately reached the forces on the ground made it clear that while kinetic operations would easily defeat the Taliban and Al Qaeda militarily, influence operations would set the conditions for success in Afghanistan.

The objectives of OEF straight forward. First, the operation had to defeat the Al Qaeda in Iraq and remove their Taliban supporters from power. Second, the coalition had to prevent the Afghan populace from perceiving the attacks on the Taliban as an attack on Afghanistan. Third, the operation had to set conditions for an Afghanistan to have a new government that did not support terror, but that would not require a large nation building effort. Fourth, the rapid defeat of the Taliban and Al Qaeda had to receive worldwide news coverage to reinforce the capabilities of the Coalition. Finally, world audiences had to realize that despite the violence of the attacks against the Taliban, the Coalition was doing everything it could to minimize the loss of life and property by Afghan civilians.

Electronic Warfare focused on the ADA and C2 networks supporting the Taliban. While EC-130H Compass Call aircraft conducted barrage jamming of Afghan C2 frequencies, EA-6B Prowlers accompanied strike aircraft to their targets. This allowed the rapid destruction of the limited Integrated Air Defense System (IADS) in Afghanistan and key C2 facilities and combat forces on the ground. Because there was limited information available about Taliban and Al Qaeda positions in southern Afghanistan, most of the targeting would occur in northern Afghanistan in support of the Northern Alliance attacks on the Taliban.

Psychological Operations focused on three objectives. First, leaflets and EC-130E/J radio broadcasts attempted to influence Taliban and Al Qaeda fighters to surrender. These products stress the capabilities of coalition forces and futility of a continued struggle given that the leaders of the Taliban and Al Qaeda had gone into hiding and had deserted the average fighter. Second, leaflets and radio broadcasts attempted to influence the Afghan populace to provide information that would lead to the capture or deaths of key Taliban and Al Qaeda leaders. A rewards program helped provide the incentive for providing this information. Third, leaflets provided information on the Humanitarian Assistance (HA) operations that occurred simultaneously with the combat operations. These products described the nature of the HA and how the Afghans could receive the HA.

Although not planned, net intrusions into and deceptions on Afghan and Taliban radio networks by US Special Forces helped guide the aircraft to their targets. The Special Forces posing as Taliban fighters on the radio convinced the Taliban forces under attack to provide feedback and targeting correction information for air strikes by having the Taliban report how far away and in what direction the bombs were exploding. The Special Forces then used this information to correct the bombing runs attacking those positions.

Key to achieving the strategic objectives for OEF was securing basing and over flight rights from Afghanistan's neighbors. This required personal engagement by General Franks, Secretary of Defense Rumsfeld, Secretary of State Powell and even President Bush. These engagements offered political and economic incentives to Tajikistan, Uzbekistan, and Pakistan to provide support to the US led coalition. In the end, Tajikistan and Uzbekistan provided basing rights while Pakistan provided over flight and over shoot rights.³⁵ The nature of the tribal and ethnic structure of Afghanistan made it difficult to unite the various factions to achieve a common goal. Even the Northern Alliance was less united than its name would suggest. To maintain the alliance and allow it to grow CIA agents and Special Forces Officers conducted intense meetings with key tribal leaders, primarily in the north, but also in the south. Money and a demonstration of superior fire power eventually convinced many tribal leaders to back what they saw as the winning side – the US led coalition.

Bombs were not the only items dropped on Afghanistan, US transport aircraft also dropped HA rations to areas that USCENTCOM identified as being susceptible to food shortages once the attacks began. The PSYOP leaflets dropped in the same area described what the yellow plastic containers on the ground were – rations provided by Coalition forces to prevent the Afghans from starving. The operations were successful in that no areas suffered any serious

³⁵ Tommy Franks, *American Soldier* (New York: Harper-Collins, 2004), 269 – 282.

reports of starvation due to the coalitions operations. Daily Pentagon press briefings made a point of identifying HA food drops as part of the military operations in Iraq (See Figure).

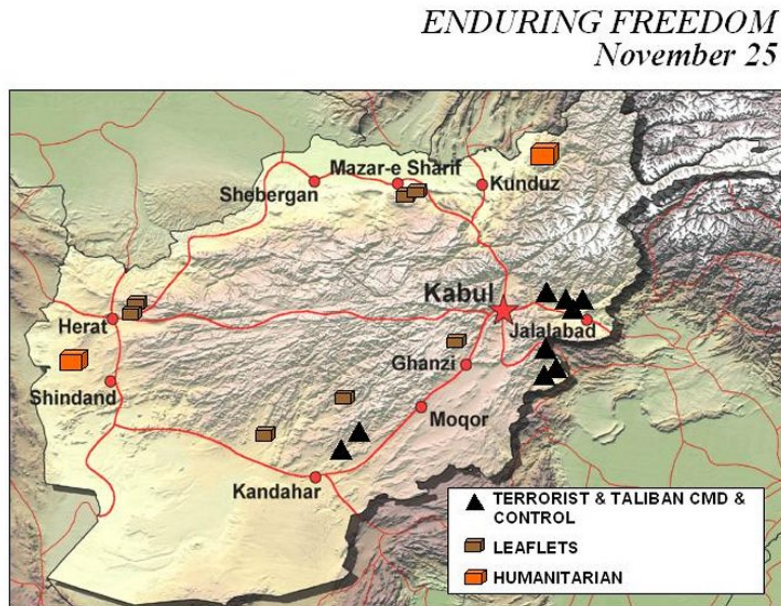

Figure 14: OEF Daily Pentagon Press Briefing Slide³⁶

Both USCENTCOM and the Pentagon kept the informed through daily press conferences. These conferences described the previous days' operations and would give examples of the successes of the coalition attacks against the Taliban. In Doha, Qatar, General Franks briefed the press while Secretary Rumsfeld or General Myers would normally provide the pentagon briefings. This pattern would continue until Hamid Karzai took the oath of office of President on 4 December 2001. From that point, pentagon briefings would only include operational updates as the situation warranted.

Intelligence on Afghanistan was sparse, especially in the south where the CIA had and USCENTCOM had almost no resources. Despite the CIA's involvement in supporting the Afghan rebels during the Soviet occupation of the 1980s and 1990s, the CIA had relatively few contacts inside the country. The Afghan terrain hindered effective collection, especially by

³⁶ *Global Security* Website, Available from <http://www.globalsecurity.org/military/ops/images/011126-D-6570C-001.jpg>; Internet.

imagery platforms. By the time the attacks began in October 2001, the Taliban and Al Qaeda had become extremely proficient at fooling imagery sensors by hiding in caves and other deception efforts. SIGINT proved just as problematic as Al Qaeda became aware that US intelligence agencies were tracking the Taliban's and Al Qaeda's leaders through their satellite cell phones and subsequently severely restricted their cell phone usage. Pakistan was able to provide some information, but given that its security service was an initial supporter of the Taliban, some of this information was surely misleading. The most reliable reporting came from Special Forces teams and CIA agents working with the Northern Alliance. National and strategic reconnaissance systems, including Unmanned Aerial Vehicles (UAVs), other reconnaissance aircraft and even satellites provided intelligence support to USCENTCOM.

Afghan National Elections

The Bonn Agreement of 5 December 2001, which laid the framework for establishing an Afghan government after the fall of the Taliban provided the timeline for the national Presidential Elections. The elections needed to occur within two years of the ELJ that determined the Transitional Government of Afghanistan. As the timeline developed two series of elections would occur. The first was the October 2004 Presidential Election. In these elections, the interim President Hamid Karzai won 55% of the vote.³⁷ The second election was the National Assembly and Provincial Council Elections of September 2005. While the Joint Electoral Management Body (JEMB) would have the responsibility of running the elections, CFC-A would bear the burden of preparing the Afghans for the elections. Preparing the Afghans for the elections ultimately meant teaching them about democracy, encouraging participation in the process while creating and sustaining a secure environment in which the elections could be held.

Between ISAF and CFC-A four themes emerged to support the elections, security, legitimacy, transparency and resolve. Security meant convincing the Afghans that the Afghan

³⁷ <http://www.elections-afghanistan.org.af/Election%20Results%20Website/english/english.htm>

government would ensure the elections could be held in a safe and secure environment. The legitimacy theme, worked to convince that the elections were fair so the Afghans would accept the results. The transparency theme was meant to reinforce the openness of the elections. The large number of international observers monitoring the election helped to ensure and reinforce the notion of the openness of the elections. The resolve theme, which was focused on international audiences, attempted to influence the members of the UN to continue with the elections no matter what anti-democratic forces in Afghanistan said or did.³⁸

To coordinate these themes and their supporting messages, CFC-A leveraged already existing organizations to focus on the election process. The JIEG would modify itself to become the Election Information Group (EIG) and would ensure a coordinated approach for public information and civic education activities of the Transitional Islamic State of Afghanistan including the Ministries of Defense and Interior, Joint Electoral Management Body (JEMB, the joint Afghan and UN organization responsible for managing the Afghan Presidential election), and United Nations Assistance Mission in Afghanistan, International Security Assistance Force (ISAF) and CFC-A in support of the Presidential elections in Afghanistan.³⁹

The EIG was responsible for developing all messages that supported the presidential elections. These messages and associated products were delivered to The EIG was so successful that the US embassy and other agencies operating in Afghanistan came to rely upon the capabilities of CFC-A to plan and execute operations.⁴⁰

Both EW and PSYOP played critical roles in setting the conditions for the elections. Electronic Warfare contributed to creating a secure environment by jamming both communications and RCIED transmitters. Coalition forces used both the Compass Call and the

³⁸ Chip Bircher, Scott Nelson, "Strategic Communications and the Afghan Presidential Election," 2005, 7 – 8.

³⁹ Ibid, 4.

⁴⁰ Chip Bircher, Scott Nelson, "Strategic Communications and the Afghan Presidential Election," 2005, 3 – 4

Prowler for these missions. Even though PSYOP was still working to separate the anti-democratic forces from the Afghan populace, it also focused on products supporting the election. Using the themes developed by the EIG the JPOTF developed posters, booklets, handouts, and radio and television broadcasts to encourage the Afghans to participate in the elections.

The tactical forces in CJTF-76 would be critical to ensuring the success of the elections. The CJTF would play two roles in preparing for the elections. First, working with Afghan security forces, the CJTF would ensure the elections would occur without disruption by anti-democratic forces. This included several deliberate operations such as Operation LIGHTNING RESOLVE to defeat the enemy forces before the elections as well as assisting the Afghan security forces maintain security during Election Day. Second, CJTF would use its tactical forces to influence the populace in the area the CJTF was responsible for. The 2-27 Infantry Brigade developed a traveling road show to help instruct the Afghans on the electoral process.⁴¹ All of the CFC-A efforts would ensure the elections proceeded smoothly and were successful. By the end of 2005, the Afghans would have their first democratically elected government in over 30 years.

Because the EIG had an intelligence cell embedded in it, the cell was able to leverage the intelligence assets and reporting to maximum effectiveness. Working with the Joint Effects Assessment Group (JEAG), the EIG was able to develop measures of effectiveness (MOE) that as a rule were detectable and achievable. Sometimes, the MOE was as simple as the number of voters who registered, other times, the MOE was the number of attacks in an area or media statements concerning the elections. These MOE came from a variety of sources including, intelligence reports, units' operational reports, face to face engagement reports and media analysis.

The reasons commanders at all levels were successfully integrated into their operations stemmed from a common understanding of the operational environment in which the

⁴¹ Ibid, 6.

commanders found themselves. This common understanding allowed the commanders' guidance to be consistent from the Secretary of Defense to the tactical commanders. The commanders on the ground also integrated their staffs to better leverage IO. This integration caused staffs to focus on leveraging all the units' capabilities to achieve the commanders' objectives.

Unfortunately, the lessons learned about having a common understanding of the environment, consistent guidance from strategic to tactical commanders and staff integration would not transfer to OIF. Almost none of the successful TTPs transferred from Afghanistan to Iraq, while none of the problems identified in OEF would be addressed for OIF. Because commanders supporting OIF did not transfer applicable lessons learned from Afghanistan to Iraq, the forces in Iraq would commit many of the same mistakes forces in Afghanistan made. This was all the more remarkable considering the same strategic and operational headquarters would plan and execute OIF.

Initial Operations in Iraq

The opening stages of OIF was one of the best examples of integrating IO into combat operations and what could go wrong when commanders did not understand the environment in which they operated. An incomplete IPB at all levels of command, supported by false strategic assumptions would lead commanders to believe that the defeat of the Iraqi Army followed by the swift capture of Baghdad would lead to the downfall of Saddam Hussein's regime and the rapid development of new democratically elected government. While Saddam's regime collapsed quickly, it would take almost three years for a democratic government to assume control of Iraq. This total focus on defeating the military and capturing Baghdad meant commanders did not focus any real attention on the aftermath of the invasion. Hardly any intelligence focused on what could happen after the regime fell and no IO products were available to set appropriate conditions in Iraq or prevent the looting and anarchy that occurred once the regime fell. In spite of this, both USCENTCOM and CFLCC integrated IO to support the combat operations that

became known as Phase III operations. The execution of the plan, however, indicated that integration was more difficult to achieve than planning the integration. The IO cell at CFLCC competed with the lethal targeting cell for scarce resources. Invariably, the lethal targeting effort took priority over the non-lethal IO effort. The changed attack timeline created by the early unplanned attack on Saddam on 19 March also disrupted the integration of IO into the operation. The changed plan created conditions in which the IO cell was unable to respond fast enough to the situation on the ground to remain truly integrated.

Because there were so few IO personnel at the units below CFLCC, (Only one IO officer – from V Corps, crossed the Iraqi border as part of the initial invasion force) the subordinate commands essentially depended on their PSYOP organizations to maintain continuity of effort with CFLCC and USCENTCOM. The USCENTCOM and CFLCC IO Objectives for combat operations were fairly straightforward. First, the Iraqis could not destroy or severely damage the southern Iraqi oil fields whose oil production would be critical for the rebuilding effort. Second, the Iraqi forces had to capitulate instead of surrender or just desert their units. The third objective was to prevent the use of weapons of mass destruction. The fourth objective was to minimize collateral damage and associated civilian casualties.

The EW shaping of the battlefield prior to the invasion began as an extension of Operation SOUTHERN WATCH (OSW). Central Air Force (CENTAF) and coalition aircraft began a process called “condition jamming” to desensitize the Iraqi reconnaissance and air defense units to disruption of their communications and radar systems. Additionally, through a series of progressively more aggressive responses to Iraqi attempts to interfere with OSW missions, coalition aircraft began to isolate Iraqi forces in southern Iraq by destroying the fiber optic and communications networks between southern Iraq and Baghdad. In part because of the successful conditioning jamming, the initial coalition air attacks caught the Iraqi defenders by surprise. Within days, the coalition air forces were able to fly anywhere over Iraq with out being concerned with long-range air defense systems.

In support of the EW shaping of the battlefield, PSYOP leaflets reinforced the messages not to target coalition aircraft and not to rebuild destroyed or repair damaged fiber optic nodes. As the war drew nearer PSYOP began the next phase of its operations, influencing the Iraqi forces to capitulate if they were attacked, to refrain damaging the oil infrastructure and to refrain from the use of WMD. Combinations of Iraqi tactical net radio broadcasts (called net intrusions) and leaflets ensured all the Iraqi units in the south received these messages over and over.

The original IO plan called for most units to receive several days of PSYOP leaflet bombs encouraging the soldiers to surrender. The most capable units of the Iraqi army never received these leaflets; coalition aircraft attacked these units without warning. The PSYOP products used these attacks as a means to demonstrate what would happen to any unit that did not capitulate. At the end of the “no attack period”, any unit that had not indicated its intent to capitulate was attacked. This reinforced the message to the remaining units to capitulate or be destroyed. The intent was that when ground forces came into contact with Iraqi forces, the Iraqi forces would have already capitulated and returned to their garrisons.⁴² The early attack on the Dora Farm Complex outside of Baghdad caused this plan to be useless since there would no longer be two week period of air attacks prior to initiating the ground attack into Iraq. Some units received these PSYOP products but essentially ignored the capitulation instructions. Once the war began, many units just disintegrated with its soldiers abandoning their equipment and returning home.

The PSYOP program designed to prevent the destruction of the southern oil fields focused on Iraqi military forces and the oil field workers. Additionally, the 1MEF’s immediate mission was to secure the oil fields to prevent the destruction of the pumps and other oil infrastructure in the area. When the 1MEF arrived, they noticed that explosives were in place,

⁴² Capitulation meant the unit not be taken into custody by coalition forces and would relieve Coalition Forces of the requirements to support the capitulated force. This reduced the logistical and security requirement on the fast moving coalition forces in their advance to Baghdad.

but many devices were rendered useless or the oil workers simply refused to carry out the orders to detonate the explosive devices.

The PSYOP program to convince the Iraqi commanders not to use WMD targeted commanders at all levels by stressing the penalties each would face if they gave the order to use WMD. These messages came via emails, and phone calls to commanders, as well as net intrusions and leaflets targeting WMD capable units. At the strategic level, the Department of Defense began to prepare the US public for the possibility of WMD use by warning where WMD use was most likely and during the ground advance provided intelligence reporting indicating that the coalition forces were approaching a “red line” at which field commanders were ordered to use WMD.

While PSYOP was successful in its role of preventing the destruction of the southern oil fields, encouraging Iraqi units to capitulate and preventing the use of WMD, PSYOP like the other elements of IO failed to set the conditions for the events that would follow the collapse of the regime. The JPOTF produced no products to prevent or limit looting or provide the civilians with instructions for dealing with coalition military forces, except avoid the roads at night and avoid Iraqi military equipment. There were not even products available to announced USCENCOM’s rewards program for information leading to WMD stockpiles, or former regime members.

There were three different deception efforts during the advance to Baghdad. The first deception aimed at Saddam Hussein. The intent was to confuse Saddam about the main effort of the Coalition Advance. To do this, USCENCOM created the impression that the main attack would come from Jordan. The timing of the attack by the Special Forces and the destruction of the Iraqi surveillance posts on the Jordanian border would give the impression that the main attack would come from the Western Desert of Iraq. The second deception served to confuse Saddam about the possibility of an attack from Turkey. USCENCOM sent indicators to Saddam that the 4th Infantry Division was actually going to come through Turkey. The intent was

to keep the Nebuchadnezzar Republican Division positioned along the Green Line between Iraq and Iraqi Kurdistan until any repositioning was too late to affect operations south of Baghdad. The messages sent to Saddam were that the Turkish Parliament vote was a sham and that the parliament would at the last minute approve the movement of forces through Turkey.⁴³ The third deception involved V Corps' attack through the Karbala gap. The object of the deception was to confuse the Adnan Republican Guard Division as to the main effort of V Corps. This would prevent the division from positioning itself to attempt to defeat the attack.⁴⁴

Even if there were products available to set the conditions for the aftermath of the combat operations, reaching the Iraqi populace became problematic with the fall of the regime. Because Saddam used the radio and TV broadcasts to command his troops in the field and to continue to spread propaganda, USCENTCOM directed attacks on the radio and TV transmitters. The side effect of the attacks was the destruction of the only nationwide radio and TV networks. Because none of the assets in the JPOTF's equipment inventory was capable of reaching the entire country, there was no way to broadcast instructions to the Iraqi people, especially to those who resided outside of Baghdad. It would take almost a year before there was a satellite broadcast from Baghdad to the rest of the country and it would take almost two years to rebuild the terrestrial radio and television networks.

In an effort to reduce the suffering of the Iraqi people, the targeting effort attempted to limit collateral damage. Sometimes military requirements either exceeded collateral damage concerns or collateral damage considerations played a minor role in determining targets. Two examples of this occurred in Bayji and Tikrit. Both bridges allowed the Iraqi military to cross the Tigris River and were the only bridges across the Tigris for over 20 miles in each direction from the bridges, but they also provided telecommunications and electricity connectivity, and, in the case of the Bayji bridge served as a critical oil pipeline from the oil fields of Kirkuk to the

⁴³ Franks, 429, 435, and 500.

⁴⁴ Fontenot, 258-261

refinery in Bayji. When CENTAF destroyed these bridges they prevented the Iraqi military from crossing the Tigris River at these critical points, but they also isolated Bayji and Tikrit from the eastern side of the Tigris River. It would take a year to repair the Bayji Bridge and almost two years to repair the Tikrit Bridge.

The media played a key role in shaping the information environment for OIF. In addition to daily press briefings from the Pentagon, the Department of Defense began a new program to provide reporters unprecedented, but controlled access to the battlefield. The embed program allowed registered media to travel with Coalition Forces into battle. These reports from the field allowed audiences across the world to witness the fastest ground assault in the history of warfare. This allowed the Coalition Forces to provide the access reporters demanded while exercising some control over what the reporters had access to. Daily press briefings from the Pentagon attempted to provide a more complete picture than what the embedded reporters saw and reported. Overall, the system worked well and reporting from the field generally presented coalition operations in a favorable light even if the Washington Press Corps disliked the daily briefings because they lacked the detail the embedded reporters provided.

Intelligence support to IO was essentially non-existent. Neither CFLCC nor V Corps had dedicated intelligence support to their IO efforts. There was no permanent intelligence presence in the IO cells of either organization. None of the commanders' PIR focused on any IO objectives beyond the capitulation of the Iraqi forces. Because PID did not focus on IO objectives, no collection assets collected information that could help either CFLCC or V Corps determine whether or not they were achieving their IO objectives.

Although Saddam's regime collapsed and the Iraqi military was essentially non-existent, things were not as coalition planners had hoped. Looting was rampant across the country, but especially in areas that had significant regime presence prior to the war. The worldwide media broadcasted the Marines pulling down the statue of Saddam on 9 April and then shortly afterwards broadcasted the looting of Baghdad by a mob of seemingly crazed Iraqis and

American Soldiers and Marines standing by, watching the looting. The popular uprising predicted by Ahmed Chalabi and several other Iraqi expatriots did not occur. The Iraqi technocrats so vital to keeping the government functioning did not return to work. Public services became non-existent. Electricity generation and distribution which had been a problem dropped to such a low level, that people had more hours without power than they had with power. Iraqi oil production and exports, which never quite reached pre-1990 levels, ceased. On 21 April, the Office of Reconstruction and Humanitarian Assistance (ORHA), formed in February 2003 moved from Camp Doha, Kuwait to Baghdad, Iraq but proved incapable of handling the situation. The military found itself responsible for a country that it had no intention of running. The military had become a de facto occupation force even if officially it was not an occupation force. Something needed to be done to bring order to Iraq. With Ambassador L. Paul Bremer's arrival in Baghdad on 12 May, the CPA assumed control of Iraq. On 22 May, the UNSC passed Resolution 1483, which acknowledged the Coalition's occupation of Iraq and called upon the occupying powers to speed the transition from occupation to a free Iraqi government.⁴⁵

The CPA assumes control

The CPA was the Bush Administration's response to the inability of ORHA to bring order to the chaos that had become Iraq. Strategically, the Bush Administration attempted to do the impossible, gain UN acceptance of the Coalition's occupation of Iraq. The CPA inherited the military's misunderstanding of the situation in Iraq, and would make its own mistakes in assuming control. The CPA did not come to Iraq prepared to deal with the information environment; most of the details were left to the CJTF-7. Typically the CPA would issue a policy or decree and then the CJTF-7 would have to develop a program to implement the policy.

⁴⁵ Larry Diamond, *Squandered Victory: The American Occupation and the Bungled Effort to Bring Democracy to Iraq* (New York: Henry Holt and Company, 2005), 38.

Early in the occupation, Ambassador L. Paul Bremer indicated he had several goals, the defeat of the insurgents, an eventual transfer of power to the Iraqis, to rebuild the country and to foster the development and growth of a free enterprise system in Iraq.⁴⁶ Every policy he instituted was aimed at achieving those goals. Despite criticism from those within and outside of Iraq he announced the dissolution of the Iraqi Army citing the Ministry of Defense's role in oppressing the Iraqi people. He also announced an intense de-Ba'athification policy that had the immediate effect of putting the Iraqi bureaucracy out of work. This effectively shut down what was left of the government. He then began a clumsy program of restoring the Iraqi economy and getting public services operational. The implementation of the reconstruction programs would become a major focus not only of the IO apparatus in the country, but also of every major command subordinate to CJTF-7. The reconstruction program would also highlight a shortcoming in CPA and CJTF-7's understanding of IO, actions matter more than words. The CPA press briefings and IO products would provide a focus on reconstruction efforts, but often words were more optimistic than reality could support.

The CJTF-7 initially did a poor job of integrating IO and unit operations. While the commanders of the subordinate US divisions to CJTF-7 reorganized their staffs to some sort of effects based approach, designed to integrate combat operations, reconstruction and IO, the commander of the CJTF-7 kept his traditional staff organization. It was not until early 2004, with the arrival of the first elements from the III Corps staff, that CJTF-7 began to take the same approach to effects as its subordinates did. Generally combat operations were controlled by the C3, reconstruction operations were controlled by the C5, and IO was controlled by the C3 IO. There was not a formal organization that brought all three elements together. This often resulted in IO programs that were disconnected from other operations.

⁴⁶ Ibid, 42.

Once major combat operations ceased, EA played an extremely limited role in OIF. As RCIEDs became more prevalent, Compass Call and Prowler aircraft began to play a significant role in defeating the RCIEDs. Coalition forces also began fielding vehicle-mounted counter-RCIED systems. Most of these systems protected high value leaders as they traveled around Iraq. The CJTF-7 IO cell did have an Air Force EW officer who coordinated with USCENTCOM for EA support, but the subordinate divisions did not, in fact they generally remained oblivious to CJTF-7 EA operations. Even the fielding of the vehicle-borne RCIED jammers was handled through the C3 with little IO involvement, especially in the subordinate divisions.

The major method of reaching the Iraqis was PSYOP. PSYOP units provided loudspeaker scripts, handbills, posters and booklet for everything from curfew announcements to the CJTF-7 rewards program to information about Transitional Administrative Law. As individual Iraqi media outlets became functional, primarily with PSYOP support, tactical PSYOP units would use those fledgling outlets to support their product dissemination. Despite a shortage of PSYOP resources (teams, mass media and timely product development) in theater, the tactical PSYOP units did a good job of reaching the Iraqi populace.

The issue with PSYOP integration during CPA's tenure in Iraq stemmed more from a failure to understand the limitations the PSYOP forces had. CPA and CJTF-7 programs habitually overestimated the effectiveness of the tactical PSYOP units in country. It was more common to see CPA/CJTF-7 programs that had unrealistic timelines for dissemination of products and equally unrealistic timelines for those products to have an effect on the populace. One notable example was the CPA weapons control program. From the announcement of the program in May 2003 until its implementation just two weeks later, the PSYOP organizations had to provide information on the program to 26 million people, all without the aid of radio and television. When the program failed, officials blamed the CJTF-7 IO staff and tactical PSYOP companies for failure to convince the Iraqis to comply with the program.

One of the most effective tools in the hands of Coalition forces was the very forces that were on the ground interacting with Iraqi citizens. The regular leader engagements between Coalition forces and Iraqi key leaders that most units conducted proved to be one of the best ways to influence events in the Iraqi tribes and governance. This program received a boost in the late summer with General Abizaid personally met with key leaders from every governorate in Iraq. The only issue with these engagements was that there was no formalized method to gather feedback from these meetings.

A tool the CJTF-7 used to share the good news with the Iraqis was the development of directed talking points. These talking points, written by the IO section, covered major operations or a two-week period and allowed all the members of the CJTF-7 to speak essentially with one voice. Originally talking points were only published sporadically as part of major operations or a specific focus area. Finally under pressure from its subordinate, the CJTF-7 developed a biweekly order that consolidated talking points for use during a specific two week time frame. Although the talking points did not change a great deal from week to week, they did provide some focus for the CJTF's subordinate commands when meeting with local Iraqis.

One person the CPA could never meet with was the Ayatollah Sistani. Prior to the war, Sistani was a senior Iraqi Shi'a cleric but no one understood his importance. By the time the CPA realized he was the most respected Iraqi Shi'a cleric, it was too late to influence him positively. Out of a desire not to legitimize the occupation of Iraq, Sistani refused to meet with anyone from the CPA. He did meet with Iraq leaders and even members of the Iraqi Governing Council. Sistani would remain a thorn in the CPA's side as he criticized not only reconstruction efforts, but also criticized the plan Bremer put forward in November 2003 to transfer sovereignty to the Iraqis.

The reconstruction of Iraq was a significant focus of IO in Iraq. The main problem with was that reconstruction was not tied to information objectives. The CPA, CJTF-7 and each of the subordinate commands spend billions of dollars to repair Iraq's infrastructure but apparently with

no focus. The Iraqi economy and infrastructure were in such bad shape that everything became priority. Even the school repairs seemed to be done without a focus. Instead of repairing specific items (schools, hospitals, warehouses, etc) in targeted locations to improve the Iraqi perception of Coalition forces, repairs were conducted on everything that was broken. This caused incremental improvement in the lives of most Iraqis, but paid few dividends in good will. IO's role was simply to publicize the good news of things being repaired. IO did not influence the decision making as to what would or should be repaired, simply to tell that something HAD been repaired.

The media continued to play a significant role in the CPAs efforts in Iraq. In fact, the media would become the primary method for communicating to the rest of the world what was happening in Iraq. The embed program continued, but it became more frequent to see reporters moving on their own throughout Iraq. In general, the media covered significant combat operations and tried to stay as close to either Baghdad or to units engaged in the hunt for Saddam Hussein as possible. In an attempt to keep the press informed of events in Iraq, the CPA conducted daily press briefings to which ever media outlets would attend. Initially, the CPA wanted to hold two separate briefings, one for non-Iraqi press, conducted by a CPA spokesman and one briefing for the Iraqi press conducted in Arabic by a PSYOP Officer. The Iraqi press refused to attend the special briefings for them and the idea was eventually scrapped in favor of a single consolidated briefing.

Intelligence support to IO during the CPA's tenure was no better than it had been during major combat operations. Because CPA was primarily a civilian organization, it had few resources of its own it could use to obtain feedback from across the country. The CPA really depended on feedback it received from the CJTF-7 or from Iraqis participating in the Governing Council. Even though the CPA was technically in charge of the situation in Iraq, its focus on reconstruction and economic development put it at odds with the CJTF-7's focus on defeating the insurgents usually meant the military's collection assets focused on insurgent targets and not on whether Iraqi attitudes were changing. (In fact the longer the occupation drew on, the more Iraqis

began to demand sovereignty over the own affairs). Of all the organizations in Iraq only the CJTF-7 had dedicated intelligence support to IO, but that did not matter as long as the commander's collection priorities continued to be on the insurgents and the fifty-five most wanted.

The OSINT analysts worked directly for the CPA Office of Strategic Communications (IO). The CJTF-7 OSINT cell produced a daily product called the "Baghdad Mosquito" which was a summary of reporting in local and regional media. The Baghdad Mosquito provided daily summaries of the regional and local media reporting on Iraq. Once a week the Mosquito featured an article on the rumors currently persisting on the streets of Baghdad. This was probably the most widely read of intelligence reporting in Iraq because it was posted not just on secret networks, but eventually was posted on the Army Knowledge Online website.

IO feedback from the subordinate commands was haphazard at best. This was as much a function lack of focus from the CJTF-7 IO section as well as the inability to decide what format subordinate reporting would be in made it difficult to solicit feedback from the subordinate IO sections. Most feedback focused on documenting measures of performance instead of measures of effectiveness. It was as though the CPA and CJTF-7 were unconcerned about whether their programs were effective and more concerned with whether or not their subordinates complied with the operations orders the command issued even if complying with the operations order would ultimately be detrimental to the information environment in which the subordinate commanders operated.

IO during the CPA's tenure in Iraq was generally unsuccessful. While there were some successes, IO failed to perform up to its potential. IO failed primarily because of a lack of focus on integrating IO into operations. By failing to allocate adequate resources to IO, CJTF-7 helped to ensure IO would not be effective. Combined overambitious timelines for the execution of IO programs, an inability to target infrastructure repairs for maximum effect, and inadequate feedback mechanisms to determine the effectiveness of IO programs, the CJTF hindered the

ability of IO to support the operational objectives. As CJTF-7 transitioned to MNC-I, it corrected many of the mistakes made in 2003, but the CPA and CJTF-7 had lost the opportunity to shape Iraqi perceptions of the Coalition and for most of the next two years the Multi-National Force – Iraq and the Multi-National Corps – Iraq would attempt to turn around the perception of the Iraqi people and world audiences. From 2004 through early 2006, two opportunities for the Coalition to turn things around would present themselves, the development of an Iraqi Constitution and Government, and the creation of functional security forces.

CONCLUSIONS AND RECOMMENDATIONS

Integrating IO into unit operations remains a significant challenge for commanders. Over the last five years, commanders have increasingly understood the necessity for integrating IO into their units' operations. Commanders at all levels readily discuss the importance of shaping the information environment. For many commanders, IO no longer remains an operational element that does not deserve the commander's personal attention. Those commanders understand, they must set the IO priorities to ensure IO is integrated into his operation. The remainder of this chapter will discuss ways the Army can better prepare its commanders for integrating IO.

This monograph has highlighted several challenges in the areas of doctrine, intelligence support to IO, and resourcing IO that the Army must address to create a solid foundation upon which commanders can build and train their staffs. The Army can ill afford to allow its commanders to grope blindly in an attempt to develop their own solutions. It is incumbent upon the Army to provide the tools and training the commanders need to effectively integrate IO.

In its discussion of Army doctrine, this monograph has shown that current Army doctrine was insufficient for providing guidance on integrating IO into unit operations. First, in reducing IO purely to an element of information superiority, Army doctrine perpetuated the misunderstanding that IO was a separate function and not an integrating function. Second, Army doctrine also has not provided clear instruction on integrating the elements of IO with each other. This included discussions on the capabilities and limitations of the various elements of IO and the assets and resources available to those elements. Third, the doctrine manuals of the elements of IO did not provide any information on how those elements relate to the other elements of IO. Finally, unit doctrinal manuals did not provide guidance for integrating IO at the unit level.

The discussion of intelligence support identified three shortcomings with intelligence support to IO. The first shortcoming in intelligence support to IO was a doctrinal shortcoming. Like other Army doctrine, intelligence doctrine suffered from the same issues as other Army

doctrine, intelligence doctrine described IO primarily in terms of achieving information superiority and not as an ability to help commanders dominate not just the information environment but also the operational environment. This meant that intelligence was incapable of helping the commander visualize the environment. The inability to visualize the information environment clearly meant the commander could not articulate his priorities for shaping the overall operational environment through the information environment. This generally meant that unit either ignored the information environment, and provided too few resources to influence the environment, or the unit targeted the wrong elements of the information environment and in turn failed to properly influence the information environment. Furthermore, intelligence support to IO assessment could not provide the long-term detailed assessments IO required to determine the effectiveness of the commander's attempts to influence the information environment. Both IO officers and intelligence analysts have failed to develop appropriate MOEs that the G2 could use to track the effectiveness of the commander's efforts to influence the information environment. Finally, there were insufficient resources for intelligence to support IO. These resources included, collectors, analytical tools (including automation support) and trained analysts to provide accurate assessments of the information environment.

Through its discussion of resourcing IO, this paper has shown there are critical resourcing issues for IO in the army. These resource shortfalls have caused commanders to develop ad hoc organizations to resource their IO efforts. The first resource issue is a personnel issue. The Army has almost a 40% shortage of required IO officers to meet requirements. Under the current USAIOP's recruiting program, it will another seven years to fill this requirement. If the results of the 2005 career field board was an indication of the types of officers drawn to IO, IO will continue to attract officers who are technically gifted but with little combat arms experience. The second resourcing issue concerned equipment issues. There was no ABCS compatible system that allowed IO planning and execution of IO operations. ABCS and CPOF did not provide adequate support IO planning and execution and current IO planning tools are incompatible with

ABCS requirements. The final resourcing issue was training officers on integrating IO. Current training programs have not exposed commanders to the realities of integrating IO and have essentially taught commanders that it was not necessary for them to integrate IO into their operations in order for the unit to be successful.

All the issues mentioned in this monograph came to light as commanders worked to integrate IO in combat operations. Those commanders who were successful made integrating IO a priority. In making IO a priority, they ensured the IO effort had sufficient resources to allow it to succeed. These commanders also ensured unity of effort in the information environment through every echelon of command. The most successful IO integration efforts involved the development of an Office of Strategic Communications. These organizations synchronized all information efforts within the command and provided embedded intelligence analysis capability to be able to focus more clearly on the information objectives.

Based on the findings expressed in this monograph, this author makes a series of recommendations to help commanders integrate IO. These recommendations follow the Doctrine, Organization, Training, Material, Leadership and Education, Personnel and Facilities (DOTMLF) format. While individual units have implemented some of these recommendations, the Army should implement these recommendations across the Army.

Doctrine

Develop a definition of IO that reduces the ambiguity of what IO is in practice. Express that definition in terms of influence, inform, attack and protect.

Ensure Army doctrine presents IO as an integrated function that can influence the information and the operational environments. Army doctrine must provide a baseline for helping the commander visualize the information environment, then describe how he wants to influence the information environment and finally how to direct his subordinates through a clear commander's intent.

FM 3-13 must include guidance on the use of Combat Camera. This guidance should also include TTPs for the use of COMCAM teams and capabilities. Joint COMCAM doctrine indicated COMCAM assets directly supported the IO effort, but Army doctrine did not even mention the use of COMCAM.

FM 3-13 must include practical guidance on integrating the elements of IO. The manual focused primarily on developing themes and objectives without presenting a baseline understanding of the capabilities and limitations of each element of IO.

Functional manuals for the elements of IO must include a discussion of the relation of that particular element to the remaining elements of IO.

FM 3-13 must include guidance on establishing and running an IOWG. Formalize the required input and output from the IOWG. (i.e. talking points, targeting input)

Targeting doctrine must be brought up to date to include both lethal and non-lethal targeting methodologies. Include a discussion of using CA to be a part of the “deliver” step of targeting, not just the “decide” or “assess” steps.

Clarify the relationship between IO and PA. Doctrine in both areas must clearly articulate the relationship between IO and PA.

Organization

Continue implementation of USAIOP plan to modernize the IO force structure recommended in the 15 September 2005 Leaders Update.

Create an office of Strategic Communications within division and higher headquarters. This office will ensure unity of effort of IO and PA while keeping the firewall between IO and PA. This organization can also serve to replace the IOWG if desired. The STRATCOM office should have a similar structure to the STRATCOM offices currently in use in Afghanistan and Iraq in that it must include IO, PA, Intelligence and some sort of POLAD representation.

Training

Develop training exercises that provide a penalty for commanders not integrating IO into their operations. Unless commanders are unable to complete their missions without successfully integrating IO, they will not view IO as a priority, even if their operations orders claim IO is a priority.

Provide IO officers opportunity to participate in Train-with-Industry programs. Civilian public relations firms have a wealth of knowledge the army must access to be able to effectively shape the information environment.

Allow IO officers to attend joint (or army developed) EW, OPSEC and MILDEC courses, program into the IO professional development curriculum. This is especially critical for officers who will serve as EW, OPSEC or MILDEC officers.

Officer professional development courses must include instruction that stress the integration of IO into unit operations. From Officer Basic Course to the War College, educational training must reinforce the requirement to integrate IO and provide practical examples on integrating IO.

Materiel

Provide IO data basing capabilities that are compatible with Army planning tools and Army Battle Command Systems. This can be through modifying current ABCS systems to support IO planning and execution monitoring requirements or modifying current IO planning tools (like ION) to be compatible with ABCS.

Increase organic the data transmission capabilities of Combat Camera Teams by providing all teams access to high-speed satellite based transmission systems. The satellite systems serving as transmission hubs in Iraq are small enough for most COMCAM teams to carry as part of their team equipment. Issue one satellite transmitter per COMCAM squad as a minimum unit of issue.

Develop an Army EA platform. The platform must have similar capabilities to the EA-6B and the EH-130H. This will relieve some of the Army's dependence on the Air Force and Navy EA assets which may have conflicting priorities serving their various components.

Leadership and Education

Commanders must demand IO integration into all their operations. In describing his view of the unit's operation the commander must include a description of how he intends to influence the information environment.

Decision makers must participate in the IOWG. As long as the commander, Chief of Staff or the G3 does not participate in the IOWG, the IOWG will remain dysfunctional and not receive full support from the staff and subordinate commanders.

The senior IO Officer must have the same access to the commander as other staff sections. Access to the commander is an indicator of how important an effort is. If the G-7 cannot have the same access to the commander as the G-3, G-4 or even the commander's special staff then IO will remain a lesser important function of the unit.

Personnel

Create an EW and MILDEC Additional Skill Identifier and code the unit TOEs for officers who have attended an EW or MILDEC qualification course.

Develop an IO enlisted MOS or at least an ASI for enlisted soldiers that allows them to be tracked as IO trained personnel. Code all non-IO MOS positions within the G-7 with that skill identifier. Soldiers who fill those positions must attend the ASI producing course.

Continue the USAOIP recruitment program to meet the personnel requirements of the USAIOP IO campaign plan. Make a concerted effort to recruit officers who possess tactical combat arms experience.

The Army has begun adapting to the environment in which it must fight the Global War on Terror. The environment requires that commanders understand the impact of information on the operational environment. Commanders have begun to more clearly visualize the information environment. Their descriptions of how they want to affect the environment have provided better guidance for their subordinates to understand their intent as it relates to the information environment. For the most part, commanders have had to adapt to the environment on their own. Commanders have done this without clear doctrinal guidance, adequate intelligence support or appropriate resources for the tasks required.

Army doctrine must change to capture the lessons learned from OEF and OIF and provide clear, executable guidance for integrating IO. The most important change to doctrine is that IO can no longer be a separate function that requires little focus from the commander, but must be an integrated function that accounts for all the activities a unit could perform. Once a doctrinal baseline exists, the required support to IO will follow. Commanders will drive the intelligence process by including IO related PIR, which in turn drives intelligence collection and analysis requirements. The revised doctrine will also cause changes to force structure and equipment requirements for the Army. These structure changes will ensure commanders have the resources they need to successfully conduct IO. Implementing the recommendations presented in this monograph will help provide the tools commanders need for success in the information environment. Eventually, the Army can achieve the level of competence in IO as it does in the realm of kinetic force on force operations.

APPENDIX A: IO AND PUBLIC AFFAIRS

Winning the media war is crucially important to Western war-planners, and increasingly sophisticated methods for doing so have been developed – albeit with varying results.

Kenneth Payne

In September 2004, when Chairman of the Joint Chiefs of Staff issued a policy memorandum to the Joint Chiefs and the commanders of the Unified Commands. In the memorandum, he stated that IO and PA are and must be separate functions within the command. He gave several reasons for this. First, PA and IO had different target audiences. PA focused on informing the “American public and international audiences in support of combatant commander public information needs at all operational levels, while IO “serves to influence foreign adversary audiences using psychological operations capabilities.”⁴⁷ Second, while admitting that PA and IO both supported military objectives by countering disinformation and deterring hostile action, the Chairman insisted both functions required separate organizations (presumably an IO cell and a PA cell). General Myers did acknowledge a requirement for coordination between IO and PA, but cautioned against the intermingling of the two.

The Chairman would not have written this memo if he did not perceive there were an issue with the way IO and PA were becoming integrated. Since 2001, there have been at least two major incidents involving the blurring of the distinction between PA and IO. The first incident was the aborted “Office of Strategic Influence” (OSI). OSI was a Department of Defense (DoD) initiative begun shortly after the 11 September 2001 attacks on the United States, to shape the perceptions of foreign audiences. OSI would even use disinformation to shape the

⁴⁷General Richard C. Myer, Memorandum titled, “*Policy on Public Affairs Relationship to Information Operation*,” 24 September 2004 1.

target audiences' perceptions.⁴⁸ In February, the Pentagon closed the OSI in the midst of concern that disinformation from the OSI would eventually be picked up by US media outlets and then the disinformation would reach a US audience.⁴⁹

The second controversial incident involving the blurring of lines between IO and PA started in 2005, when the *LA Times* published an article claiming that DoD contractors from the Lincoln group were paying Iraqi newspapers to publish pre-written pro-US articles in their papers. The paper pointed out that although the articles were “basically factual”, they were biased and presented only the US side and ignored information that was less than favorable to the US.⁵⁰ In both of these incidents, the US press was most critical because it claimed that Pentagon's actions were damaging the perception that media was an impartial presenter of the news. The press also claimed that there were potential violations of US law by using the media to influence US audiences.

These two incidents have drawn attention to an issue that until the last fifteen years could not have been an issue – how IO and PA relate to one another. This was not an issue in World War II, Vietnam, Korea or even to some degree Desert Storm primarily because information disseminated in a theater of war stood little chance of reaching audiences in the United States. With the advent of the internet, twenty-four hour global news coverage, relatively inexpensive satellite phones and radios it became possible for information meant for one target audience to be received by another target audience. CNN used as an example the ability of shortwave radio operators in the US to receive PSYOP radio broadcasts urging the Taliban in Afghanistan to surrender. In effect, technology blurred the lines between PA and IO without the Pentagon's help.

⁴⁸ *Cable News Network Website* Available from <http://archives.cnn.com/2002/US/02/19/gen.strategic.influence/>; Internet.

⁴⁹ *Cable News Network Website*, Available from <http://archives.cnn.com/2002/US/02/26/defense.office/>; Internet.

⁵⁰ *The Los Angeles Times Website*, Available from <http://www.latimes.com/news/nationworld/world/la-fg-infowar30nov30,0,5638790.story>; Internet.

In his article “Why Public Affairs Is Not Information Operations,” Colonel William Darley argued that integrating IO and PA somehow diminished the value and usefulness of PA. He based his article on the false notions that PA and IO were at their roots incompatible and that there is a clear distinction in the information available to US, friendly or neutral foreign audiences and hostile audiences. In other words, there could be no bleed over from information given to foreign (adversary) audiences and information given to US and foreign (non-adversary) audiences. While commanders understood that adversary audiences and US audiences were different targets requiring different information, the realities of modern technology made it increasingly difficult to ensure separation.

In January 2005, the Public Relations Society of America (PRSA), the largest Public Relations professional organization, issued a Professional Standards Advisory (PSA) that provided the following guidance:

To reduce the confusion inherent in wartime communication, there must be a firewall separation between IO and PA and a mechanism based on disclosure, exposure and public discussion to reestablish a basis of truth and trust when situations of honesty, clarity and truthfulness have been breached. *Coordination between PA and IO is essential to maintain the firewall.*⁵¹ (Emphasis added)

The PRSA gave little guidance to maintaining that separation and used the guidance from GEN Myers to support their argument. The PRSA used the deception involving a potential Marine landing in Kuwait during Operation DESERT STORM to illustrate the dilemma the PAO faced when he was aware of the deception and how it was a vital part of the commander’s plan to defeat the Iraqi forces in Kuwait.

So how do commanders maintain that “firewall”? Surprisingly, doctrine gave little direction. Lack of guidance in doctrine and the transformation of IO to a Public Relations (give

⁵¹ *The Public Relations Society of America Website*, Available from http://www.prsa.org/_News/leaders/ps50114.asp; Internet.

the good news) mindset, especially in Iraq, would cloud the issue even more. Sometimes commanders would use PA strictly to communicate to the US and international press and use PSYOP to communicate with indigenous press. Because PSYOP soldiers were comfortable dealing with local audiences and communicated well to the indigenous press, this method achieved some degree of success in keeping IO and PA separate, until the indigenous press demanded US commanders treated them the same those commanders treated the international press. So they had the same problem again, how to reach local audiences and international audiences with potentially different messages without compromising the message to either audience.

As a practical measure, this author would like to suggest the following as a TTP:

IO in its responsibility for shaping the information environment develops the information objectives for the operation.

It is the responsibility of the PAO and PSYOP planners and executors to ensure that their products and releases support that environment.

The IOWG becomes the forum that de-conflicts products and general releases from PSYOP and PAO. This requires that a decision maker for the command actually attend the meeting.

Have a command spokesperson who can speak to the press and who hosts whatever press briefings there may be. The PAO can help prepare the spokesperson but should not serve as the spokesperson.

Minimize the PAO's involvement in deception planning. This allows the PAO to maintain the ethical standards of profession by not putting him in a position where he would intentionally provide false or misleading information.

Treat all press the same regardless of whether it is indigenous or not.

Create a series of battle drills that help synchronize the command when it has to deal with unexpected crises and when unity of message may be critical.

In the highly interconnected world of the twenty-first century, it has become increasingly difficult to maintain a separation between IO and PA. Misunderstandings in the public about the functioning of IO and PA and their relationship to one another require that the Army examine this relationship. Failure to do so will ensure that the commanders continue to blur the distinction between IO and PA. Combining IO and PA causes two problems for the commander. First, the commander could cross a legal boundary. Second, the command loses credibility with both target audiences. Either result will create a situation that causes problems for the command and will take significant effort to repair the damage this causes.

APPENDIX B: IO AND TARGETING

The ability to properly identify, track, deliver the intended message and then to assess the effect of the message of critical to conducting effective IO. The current version of FM 5-0 stated:

Targeting is the process of selecting targets and matching the appropriate response to them, taking into account of operational requirements and capabilities (JP 1-02). It is an integral part of Army operations. Based on the commander's targeting guidance and targeting objectives, the targeting team determines what targets to attack and how, where, and when to attack them. It then assigns targets to systems best suited to achieve the desired effects.⁵²

The targeting process as defined by FM 5-0 was characterized by four distinct steps, Decide, Detect, Deliver, and Assess (D3A). Even though FM 5-0 indicated the G-7 (IO Officer) is on the targeting board, Army doctrine tended to look at targeting from a kinetic perspective. Because FM 6-20-10, *TTPs For the Targeting Process*, was written before current operations doctrine, it does not consider the requirements for IO targeting. Even FM 3-13 *Information Operations* addressed targeting primarily from a kinetic perspective. To be sure, FM 3-13 did mention non-lethal targeting and requirements of non-lethal targeting such as the long lead times and unique assessment requirements, but Appendix E (IO Targeting) seemed to present non-lethal targeting more as a subset of lethal targeting and not a subset of targeting in general.

The targeting process occurs inside of the MDMP Cycle and the Operations Process of Planning, Preparation, and Execution with assessment providing feedback throughout the process. The following chart from FM 3-13 presents a view of the targeting process overlaid in the MDMP. This chart is a modification of the targeting process presented in FM 5-0. The modifications in FM 3-13 identify the IO requirements for each step in the process.

⁵² US Army Field Manual 5-0, *Army Planning and Orders Production* (Washington, DC: Headquarters, Department of the Army, 2005), H-1.

	Operations Process Activity	Targeting Process Activity	Targeting Task
A S S E S S M E N T	Planning	Decide	<p>Mission Analysis</p> <ul style="list-style-type: none"> · Develop IO-related HVTs · Provide IO input to targeting guidance and targeting objectives <p>COA Development</p> <ul style="list-style-type: none"> · Designate potential IO-related HPTs · Contribute to TVA · Deconflict and coordinate potential HPTs <p>COA Analysis</p> <ul style="list-style-type: none"> · Develop HPTL · Establish TSS · Develop AGM · Determine criteria of success BDA requirements <p>Orders Production</p> <ul style="list-style-type: none"> · Finalize HPTL · Finalize TSS · Finalize AGM · Submit IO IRs/RFIs to G2
	Preparation and Execution	Detect	<ul style="list-style-type: none"> · Execute collection plan · Updated PIRs/ IO IRs as they are answered · Update HPTL and AGM
		Deliver	<ul style="list-style-type: none"> · Execute attacks in accordance with the AGM
			Assess

Table 3: Targeting and the MDMP⁵³

⁵³ US Army Field Manual 3-13, *Information Operations* (Washington, DC: Headquarters, Department of the Army, 2004), E-2.

Example Integration of MDMP, Targeting and IO

Given the framework presented in FM 3-13 and the four functions of IO presented in the introduction of this monograph, this author would like to present a method for conducting targeting that ensures the integration of all the elements (core, related and supporting) of IO with each other and ensures IO's integration with the operation to ensure IO supports the overall commander's intent. The example occurs in Table 4 in the next four pages. Using concrete examples of targets, information requirements, delivery systems, collection systems and assessment tools, this example should help clarify integrating IO into the unit's operations. For background, this scenario occurs in an environment similar to Iraq today. Although the entire scenario is hypothetical, the elements that make up the scenario did occur.

Targeting Step	MDMP Step	Staff Proponent	Product	Supporting or Additional Information Considered
Commander's Planning Guidance: I want to ensure movement of petroleum products along Highway 1 to prevent a shortage of gasoline as we go into the Muslim new year. I also want to give the new police forces a chance to prove their abilities to provide security.				
Decide	Mission Analysis	G2 (With input from other sections)	Initial HVTL: Sheik in Bayji (Neutral) Mullah in Tikrit (Pro-Insurgent) IED maker in Ad Dawr Market in Dujayl (known arms market) Roadside shop keepers between Tikrit and Bayji	Key Communicators Religious Leaders Insurgent Financiers IED Makers Insurgent Leaders HUMINT Collectors Civic Leaders Former military Status of infrastructure Cultural Issues Upcoming holidays Cost of munitions on black market Current civilian gasoline production and distribution into AO Current Electricity production Past gasoline and electricity consumption CA Assessments
			PIR: What times are the IEDs being placed on HWY 1? Will civilians hoard fuel before the New Year? Who is financing IED manufacturing?	Reporting from: THTs CA Teams PSYOP Subordinate Units UAV Higher Headquarters

Targeting Step	MDMP Step	Staff Proponent	Product	Supporting or Additional Information Considered
		IO	EEFI: Convoy Routes Convoy Times Raid Timeline Raid Location Location of RCIED jammers in convoys	Enemy collection capability Indicators of Coalition action and intent
Initial Targeting Guidance and Objectives: Neutralize anti-coalition propaganda Reduce availability of munitions in the AO Prevent hoarding of or run on gasoline Suppress IED threat on Highway 1 Give indigenous security forces the lead where possible.				
Decide	COA Development	Targeting Section	Prioritized Targets: IED maker in Ad Dawr – Maneuver lead Market in Dujayl - Maneuver Lead, PSYOP/CA Support Roadside shop keepers between Tikrit and Bayji – Maneuver Lead, PSYOP Support Sheik in Bayji – Maneuver Lead, CA Support Mullah in Tikrit – Maneuver Lead	Lead time for PSYOP Collection time for CA teams to determine price of fuel Time to move COMCAM to cover raid, process and transmit images
	COA Analysis	Targeting Section	Prioritized Targets (AGM): IED maker in Ad Dawr – Maneuver lead Market in Dujayl - Maneuver Lead, PSYOP/CA Support Roadside shop keepers between Tikrit and Bayji – Maneuver Lead, PSYOP Support Sheik in Bayji – Maneuver Lead, CA Support Mullah in Tikrit – Maneuver Lead TSS for targeting	

Targeting Step	MDMP Step	Staff Proponent	Product	Supporting or Additional Information Considered
		Targeting Section (IO, CA, G2, FSE)	<p>MOE:</p> <p>Reduction in the number of IED emplaced</p> <p>Increase in black market price of munitions</p> <p>Number of reports from shop owners about activity on HWY 1</p> <p>Sheik publicly advocates cooperation with coalition</p> <p>Reduction in threats against Mullah</p> <p>Length of lines at gas stations</p> <p>Price of gas</p>	<p>When is the information needed?</p> <p>Who can collect the information?</p> <p>How is the information collected?</p>
	Orders Production		<p>Generate OPOD:</p> <p>1BCT – Influence Sheik in Bayji to support Coalition</p> <p>1BCT – Neutralize IED maker in Ad Dawr</p> <p>2BCT – Secure HWY 1 between Tikrit and Bayji</p> <p>3BCT – Neutralize arms market in Dujayl</p> <p>MP – Protect fuel convoys</p> <p>TPC – Develop program to influence civilians not to hoard fuel</p> <p>TPC – Develop program to convince civilians to provide information on IED makers & planters</p> <p>PAO – Inform of the capture of arms dealer in Ad Dawr</p> <p>SJA – Ensure reward program funds flow smoothly</p> <p>Collection Plan focuses on PIR</p> <p>Coordinating Instructions</p> <ul style="list-style-type: none"> - Monitor fuel prices in AO - Monitor length of lines at gas stations - Inform civilians of successes in AO - Allow indigenous security forces to take the lead where possible. 	<p>Use task oriented language – Neutralize, defeat, suppress, identify, engage, document, etc.</p> <p>IO annex should include IO Objectives, talking points, etc</p> <p>Include IO synch matrix as appropriate</p> <p>Include reporting timelines as required</p> <p>PSYOP appendix should include supporting PO, SPO</p> <p>EW annex includes guidance for EA assets</p> <p>OPSEC Annex include measures for protecting EEFI</p> <p>May include guidance as to preferred method is lethal or non-lethal.</p>

Targeting Step	MDMP Step	Staff Proponent	Product	Supporting or Additional Information Considered
Detect	Execution	G2 (Assisted by other agencies)	Monitor execution of collection plan	Process reporting from maneuver units; PSYOP, CA, MP, OSINT, MI Collectors
Deliver		Maneuver Units and Staff Elements	Execute tasks to subordinate units	First indications of MOPs being fulfilled.
Assess		G2 (Assisted by other agencies)	MOP – Did units do what they were assigned? MOE – Did our actions achieve the desired results?	Process reporting from maneuver units; PSYOP, CA, MP, OSINT, MI Collectors

Targeting Step	MDMP Step	Staff Proponent	Product	Supporting or Additional Information Considered
As execution occurred:			<p>1BCT – Working with local security forces, arrested IED maker in Ad Dawr. Local security forces actually enter the building to arrest suspect, US forces form outer cordon. Embedded reporter from Fox covers raid, reports US and local security forces arrested major bomb make in Ad Dawr. BN CDR meets with local sheiks to discuss fuel situation in Ad Dawr, lines are 50% longer than average.</p> <p>2BCT – Increased patrols along HWY 1, patrol leader engagements with roadside shop owners identified two merchants who were providing information on convoy movement on HWY 1 south of Bayji, two days later one shop owner no longer seen on the road, the other shop owner is arrested. The Brigade Direct Support CA teams in meetings with the neutral sheik in Bayji learns that he is concerned the fire department does not have the capability to respond to a fire larger than a small stand alone building. The CA team recommends to the Brigade Commander to provide upgraded fire trucks to the station, since the current trucks are over thirty years old. The commander approves the request and forwards the request to the Division Commander for his approval.</p> <p>3BCT – Supports indigenous security force midnight raid on arms market in Dujayl, hundreds of weapons and explosives seized. COMCAM accompanies local security forces on raid. Stills and video used in PSYOP programs to highlight success of security forces.</p> <p>MP – escorted convoys through Division AO, one convoy attacked with RCIED, three killed. Three RCIEDs explode before convoy reaches kill zone. PAO rides with MPs generates a new report that is featured on local US paper.</p> <p>SIGINT leads from monitoring IED maker’s communications leads to two more arrests outside Ad Dawr</p>	

Table 4: Example MDMP/Targeting Crosswalk Integrating IO

To make an example like this work, FM 2-0, FM 3-0, FM 3-13, FM 5-0 and the revisions to FM 6-20-10 and FM 34-130 (FM 2-01.3) must present IO as integrated into a units operations including targeting. The D3A process in doctrine must focus on timelines beyond the traditional ATO cycle and provide guidance on developing and tracking MOEs that develop over an extended period of time (perhaps weeks or months). This also requires a change to the collection management process. Collection management can no longer concern itself with MI sensors alone, but must take into account reporting from non-MI sources. Collection management must also change its methodology of tracking targets over a twenty-four hour period to tracking targets for weeks if necessary. To support analysis and assessment, there must be standardized reports from CA, PSYOP, PA, EW, Leader Engagements, and Routine Patrols, that ABCS can process and aid in analyzing the reporting to determine the effectiveness of the targeting effort.

APPENDIX C: IO UNIT STRUCTURES AND EQUIPMENT

CAPABILITIES

As an aid to understanding the Capabilities of the IO assets discussed in this monograph, this Appendix provides information on the assets used to shape the information environment during OEF and OIF. The first section provides information on the PSYOP units and equipment. The second section covers PA assets. The third section covers COMCAM organization and equipment. The fourth section covers unclassified EA assets.

PSYOP Units and Equipment

EC-130E/J Commando Solo



Figure 15: EC-130J Commando Solo⁵⁴

The EC-130 Commando Solo (Figure 15) is an airborne radio and television broadcast platform. There are currently only six aircraft in the inventory. All six are flown by the 193rd

⁵⁴ Federation of American Scientists Website, Available from <http://www.fas.org/man/dod-101/sys/ac/ec-130-00000002.jpg>; Internet.

Special Operations Wing of the Pennsylvania Air National Guard. Although its primary mission is support of PSYOP, it has the ability to conduct EA missions and to perform limited SIGINT missions.

It has the capability to broadcast on AM, FM, Shortwave radio frequencies and VHF and UHF television frequencies. Its transmitters can target both civilian and military frequencies. At a flight altitude it has an approximate transmission range of about 174 KM before line of sight issues degrade reception by the receiver. Quality television reception is generally significantly less.⁵⁵

Transmission Capabilities:⁵⁶

Number of Transmitters	Frequency Range	Power Output	Modes
1	.45 – 2 MHz	10 Kw	AM/SSB
1	2 – 30 MHz	10 Kw	AM/SSB
2	30 – 230 MHz	1 Kw	AM/FM
2	100 – 500 MHz	1 Kw	AM/FM
2	470 – 1000 MHz	1 Kw	AM/FM
1	47 – 88 MHz	10 Kw	TV Channels 2 - 69
	170 – 230 MHz		
	470 – 860 MHz		

Table 5: Commando Solo Transmission Capabilities

⁵⁵ Office of the Under Secretary of Defense for Acquisition, Technology and Logistics, *Report of the Defense Science Board Task for On: The Creation and Dissemination of All Forms of Information in Support of Psychological Operations (PSYOP) in Time of Military Conflict* (Washington, DC: 2000), 48 – 50.

⁵⁶ Special Warfare Center and School, *Psychological Operations Handbook: Equipment Types, Specifications, and Capabilities* (Fort Bragg: 2005), 55.

Special Operation Media Systems – B (SOMS-B)



Figure 16: SOMS-B in Afghanistan⁵⁷

The SOMS-B (Figure 16) is a ground-based HMMWV mounted radio and television broadcast system. Like the EC-130C/J it can broadcast on AM, FM, SW and VHF television frequencies. The SOMS-B also has the capability to produce programming for radio and television broadcasts. The ranges listed in Table 6 are maximum transmission ranges, actual ranges are usually much shorter.

⁵⁷ US Military Joint Publication, *Doctrine for Joint Psychological Operations* 3-53 (Washington, DC: Department of Defense, 2003), 4-3.

Transmission Capabilities⁵⁸

AM Transmission		
Range	Frequency	Power
400 KM	530 – 1710 KHz	5Kw
FM Transmission		
Range	Frequency	Power
64 KM	66 – 108 MHz	1Kw
Television Transmission		
Range	Channels	Power
N/A but is probably less than 60 KM ⁵⁹	1 – 13 in PAL, SECAM or NTSC	1Kw

Table 6: SOM-S Transmission Capabilities

⁵⁸ Special Warfare Center and School, *Psychological Operations Handbook: Equipment Types, Specifications, and Capabilities* (Fort Bragg: 2005), 47.

⁵⁹ Office of the Under Secretary of Defense for Acquisition, Technology and Logistics, *Report of the Defense Science Board Task for On: The Creation and Dissemination of All Forms of Information in Support of Psychological Operations (PSYOP) in Time of Military Conflict* (Washington, DC: 2000), 49.

Tactical PSYOP Battalion

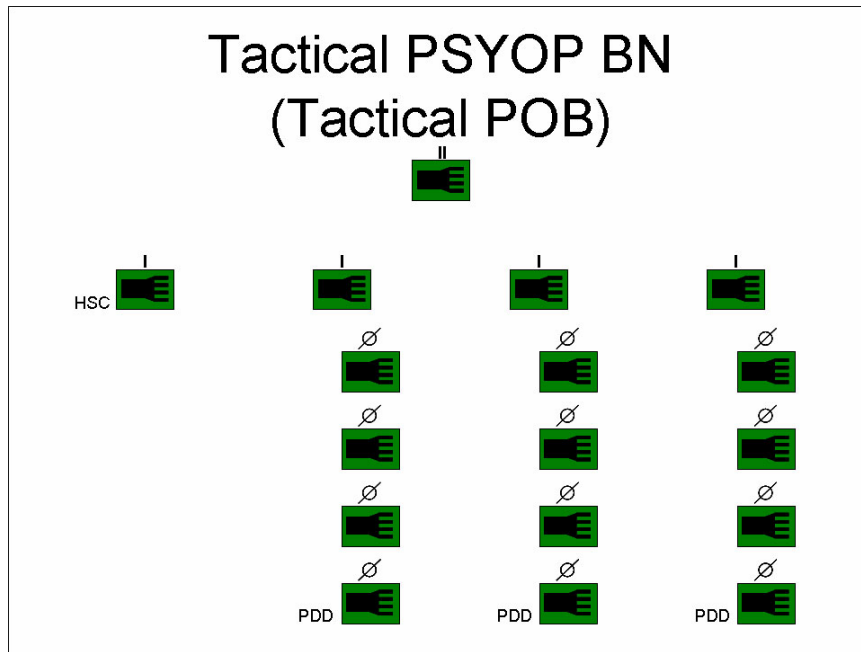

Figure 17: Tactical PSYOP Battalion⁶⁰

The organization shown Figure 17 is the typical Tactical PSYOP Battalion structure. This is the type of Battalion that supported CJTF-7 in OIF. Ordinarily the Tactical POB would also receive assets from the Dissemination PSYOP Battalion from the supporting PSYOP Group. With these additional assets, the POB can now produce and disseminate print and broadcast PSYOP products throughout the JTF's Area of Responsibility.⁶¹ Without additional production capabilities, the POB is limited to its Risograph for producing printed products. (120 pages per minute or 93,000 single color leaflets in 24 hours)⁶²

⁶⁰ US Army Field Manual 3-05.30, *Psychological Operations* (Washington, DC: Headquarters, Department of the Army, 2005), 3-8.

⁶¹ Ibid.

⁶² Special Warfare Center and School, *Psychological Operations Handbook: Equipment Types, Specifications, and Capabilities* (Fort Bragg: 2005), 20.

Tactical PSYOP Company

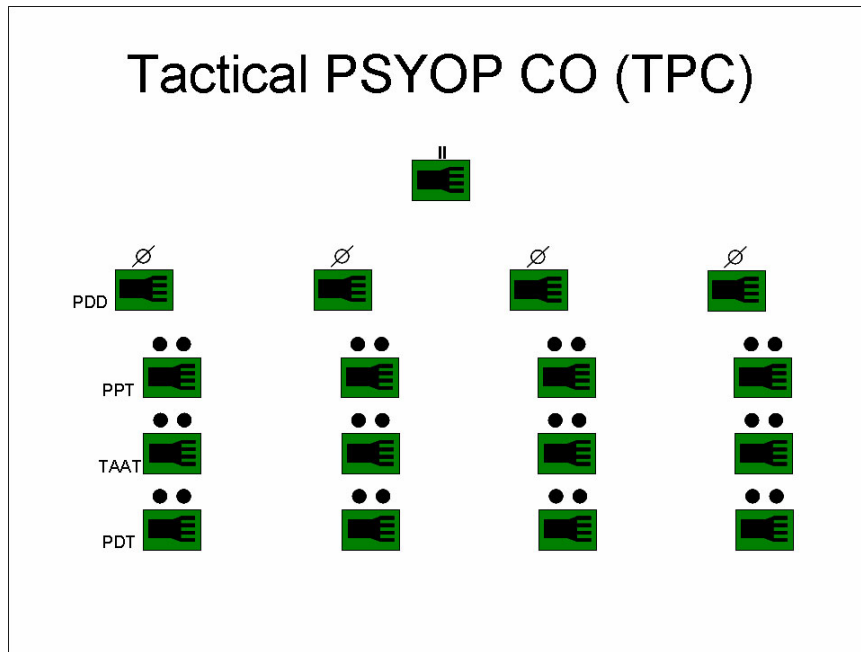

Figure 18: Tactical PSYOP Company⁶³

The TPC shown in Figure 18 generally supports a division-sized element. It has a limited capability to develop and produce printed PSYOP products, radio messages and loudspeaker scripts for its three Tactical PSYOP Detachments (TPDs). The Product Development Detachment (PDD) is responsible for PSYOP product development for the company. Within the PDD, the Plans and Program Team (PPT) is responsible for implementing the PSYOP plan to support the commander. The Target Audience Analysis Team (TAAT) identifies and refines potential targets for the PSYOP Products. The Product Development Team (PDT) does the actual product development.⁶⁴

⁶³ US Army Field Manual 3-05.30, *Psychological Operations* (Washington, DC: Headquarters, Department of the Army, 2005), 3-10 – 3-11.

⁶⁴ *Ibid*, 3-6 – 3-10.

Mobile Public Affairs Department

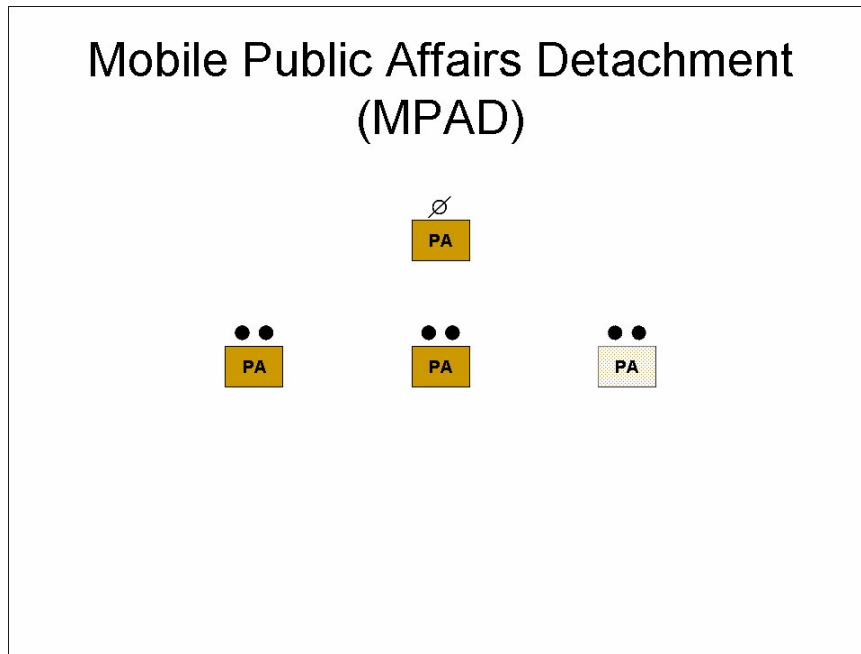

Figure 19: MPAD⁶⁵

The MPAD has the capability to augment the supported unit's PA assets. Although Figure 19 indicates there are three teams in the MPAD, the MPAD could in fact only have two teams assigned to it. The MPAD brings the capability to produce and distribute text, audio and visual products for use within and external to the command. It can also help manage media operating in the unit's area of operations.⁶⁶

⁶⁵ US Army Field Manual 46-1, *Public Affairs Operations* (Washington, DC: Headquarters, Department of the Army, 1997), 47.

⁶⁶ *Ibid.*

Combat Camera

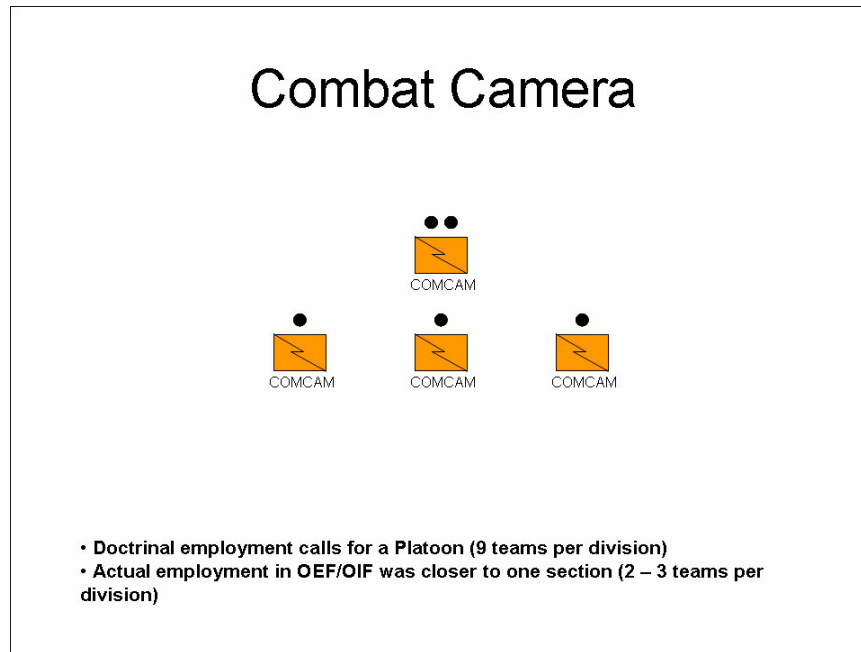

Figure 20: Combat Camera Detachment⁶⁷

The organization in Figure 20 depicts a typical COMCAM Squad similar to the organizations that provided documentation support to OEF and OIF. An Army COMCAM documentation squad generally consists of three teams of two persons each. Each team has the capability to document operations using still photography and video. Although the teams have a limited ability to produce final edited products, their main function is to document events on the battlefield and provide properly annotated products for use in unit briefings, PSYOP and PA products, higher headquarters products, and ultimately at the Department of the Army and SECDEF Level. Each team may have INMARSAT access for short term uploading of products to a central server (at the Joint Combat Camera Center) for use by the editing teams normally found at an operational level headquarters or higher.⁶⁸ Unless the documentation teams provide their own high-speed transmission capability (which is rare), the team is dependant upon the

⁶⁷ US Army Field Manual 3-55.12, *Multiservice Tactics, Techniques and Procedures for Joint Combat Camera Operation* (Washington, DC: Headquarters, Department of the Army, 2003), D-8.

⁶⁸ Ibid, D-8 – D-9.

capabilities of the unit they support.

Electronic Warfare

With the exception of ground based assets used in TF IED, the Army does not have any EA assets of its own. Instead it must rely on assets provided by the Air Force and the Navy. Those assets are the EC-130H Compass Call and the EA-6B Prowler. Both aircraft can jam tactical communications, some cell phones, as well as some remote control devices used to detonate RCIEDs.

EC-130H Compass Call



Figure 21: EC-130H Compass Call over the desert⁶⁹

The Compass Call (Figure 21) is an airborne communications jamming platform that can jam multiple frequencies both in the civilian and military portions of the spectrum. It has the capability of jamming multiple frequencies at once. The crew can upload mission profiles prior to the mission and still receive updates to that profile while it is in flight.⁷⁰ Because it is a slow aircraft with a fixed orbit and its jamming systems are so powerful, the Compass Call is usually used to cover a broad area and rarely crosses into enemy airspace.

⁶⁹ Federation of American Scientists Website, Available from <http://www.fas.org/man/dod-101/sys/ac/ec130-01.jpg>; Internet.

⁷⁰ Federation of American Scientists Website, Available from <http://www.fas.org/man/dod-101/sys/ac/ec-130e.htm>; Internet.

During OEF and OIF, the aircraft focused on ADA, fire support and C2 nets for the major combat operations, later they would become part of TF IED.

There are currently thirteen aircraft in the inventory. They are in two squadrons of six aircraft each and based out of Davis-Monthan Air Force Base in Tucson, AZ.

EA-6B Prowler



Figure 22: Two EA-6Bs refueling over the desert⁷¹

The EA-6B Prowler (Figure 22) is airborne jamming system. In combat operations the Prowler accompanies strike aircraft to their target. In addition to its jamming capabilities it also has the High Speed Anti-Radiation Missile (HARM) to destroy the radars of ADA systems that target the aircraft. The Air Force, Marines, and Navy all fly this aircraft. Every aircraft carrier includes at least one squadron of Prowlers (4 aircraft) in its compliment of aircraft. During major combat operations it supported strikes against combat forces. Today it serves as part of TF IED.⁷²

⁷¹ *Federation of American Scientists* Website, Available from <http://www.fas.org/irp/program/collect/ea-6b-dvic250.jpg>; Internet.

⁷² *Global Security* Website, Available from <http://www.globalsecurity.org/military/systems/aircraft/ea-6.htm>; Internet.

APPENDIX D: SELECTED UNIT IO STRUCTURES AND ORGANIZATIONS

The following charts depict the IO organizational structures from units that participated in OEF and OIF. The first few charts depict the authorized TOE for the IO sections of units that participated in OEF and OIF. The next charts depict the actual IO task organization these units developed to conduct their IO programs.

Prior to 2004, most Divisions and every Corps had minimal IO staffs. The Divisions (Figure 23) had authorizations for only one IO officer, one PSYOP Officer and one PSYOP NCO. The Corps (Figure 24) had authorizations for three IO officers, one PSYOP officer and one PSYOP NCO. Only the 4th Infantry Division and the 1st Cavalry Division (Figure 25) had authorizations for more than one IO officer on their staffs.

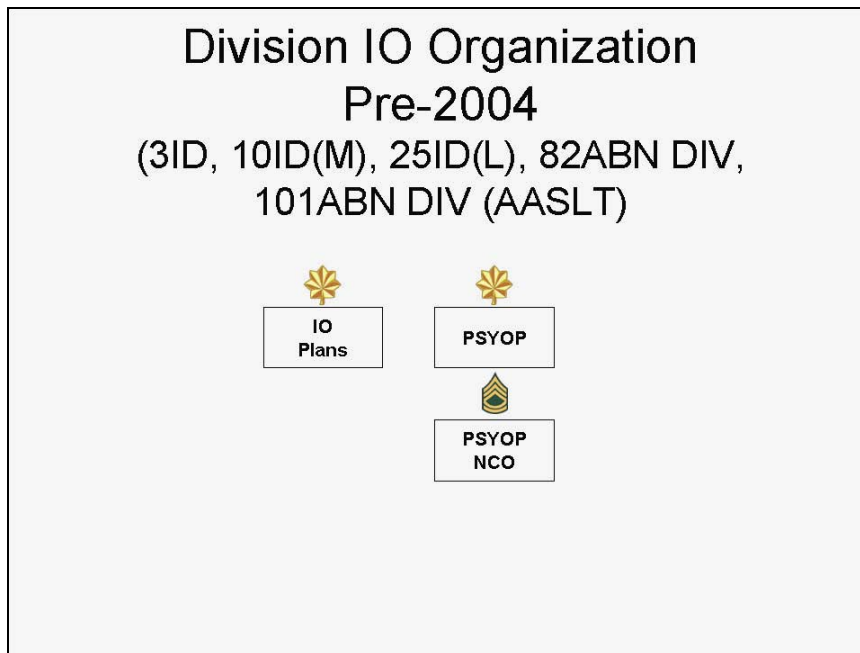

Figure 23: Pre-modular Divisional IO structure⁷³

Even though units listed in Figure 23 had authorizations for IO officers, personnel shortages within the IO career field, meant that these divisions did not have IO officers as part of

⁷³ *United States Army Force Management Support Agency Website*. Available from <https://webtaads.belvoir.army.mil>; Internet

their permanent staffs. If they received IO officers, they would be in the form of augmentees assigned to the Division only for the duration of the conflict.

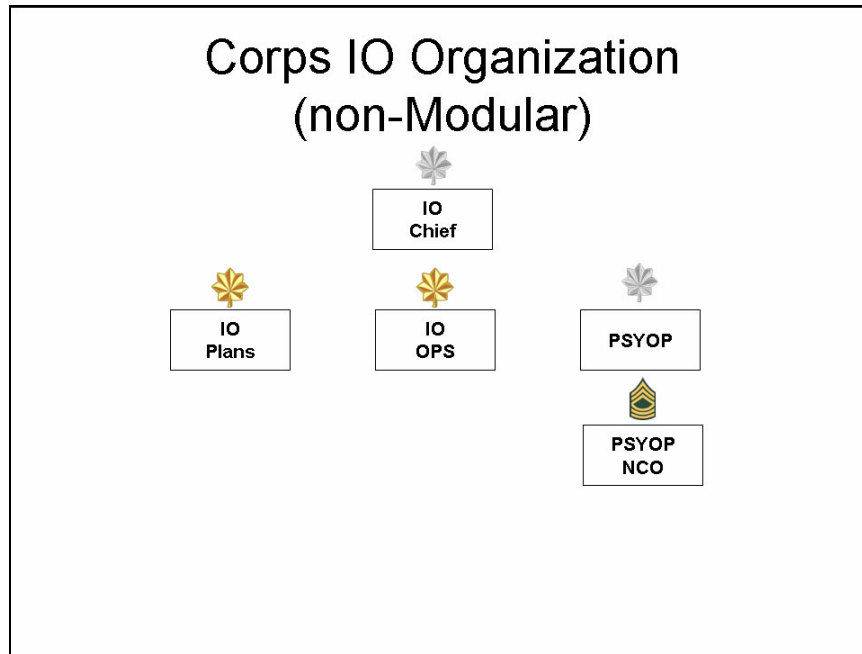

Figure 24: Typical Corps IO Organization⁷⁴

All the Corps deploying in support of OEF and OIF had authorizations for five person IO cells, but the same personnel shortages that prevented the Divisions from having fully-manned IO cells would prevent the Corps from having fully manned IO cells. The Corps would have to depend upon Joint Manning Documents to provide the IO staff resources they required to complete their missions.

⁷⁴ *United States Army Force Management Support Agency Website*. Available from <https://webtaads.belvoir.army.mil>; Internet.

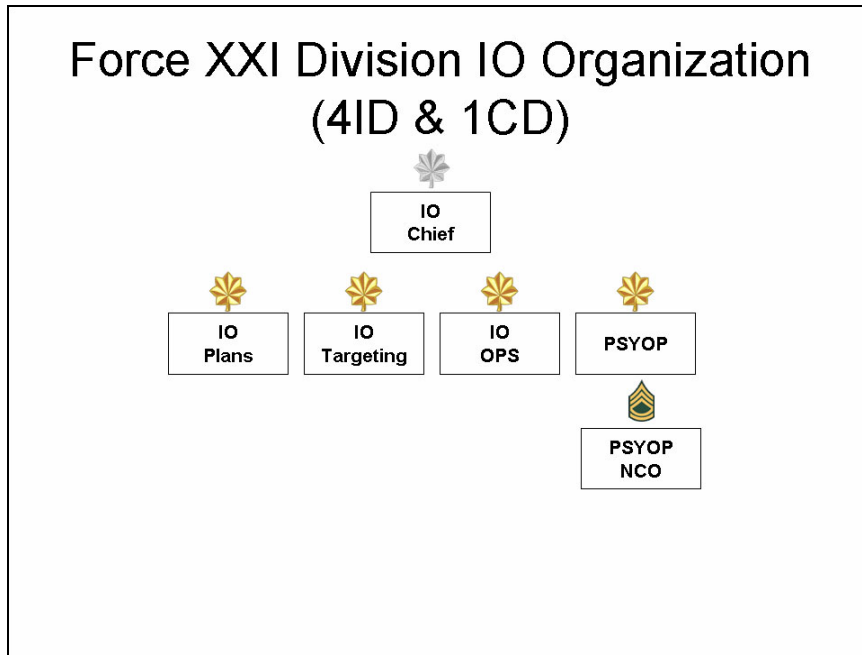

Figure 25: Force XXI IO Organizations⁷⁵

The Force XXI divisions had the most robust IO staff organizations of any units in the Army. They would not have a complete staff prior to their deployments to OIF. Even in theater, the staffs depended upon 1st IO Command FSTs or Division internal staff reorganization to provide resources to the IO cells.

As units began to deploy to OEF and OIF, they began requesting IO officers to round out their MTOE requirements. Units would receive what was available in the active Army, but that essentially meant there were no IO officers available. Units generated requests for FSTs, but the Army G3 disapproved most division requests. Corps would receive some FSTs. Any unit with a JMD would receive IO officers, some from the Active Force and some from the Reserve Component IO Commands.

The deployment of the 3rd Infantry Division to Iraq in 2004/2005 was the first deployment of units using the new modular design (Figure XX). While the 3rd Infantry Division

⁷⁵ *United States Army Force Management Support Agency Website*. Available from <https://webtaads.belvoir.army.mil>; Internet.

used a hybrid version of the modular design, the 4th Infantry Division and the 101st Airborne Division (Air Assault) deployed in late 2005 with structures closer to the modular design.

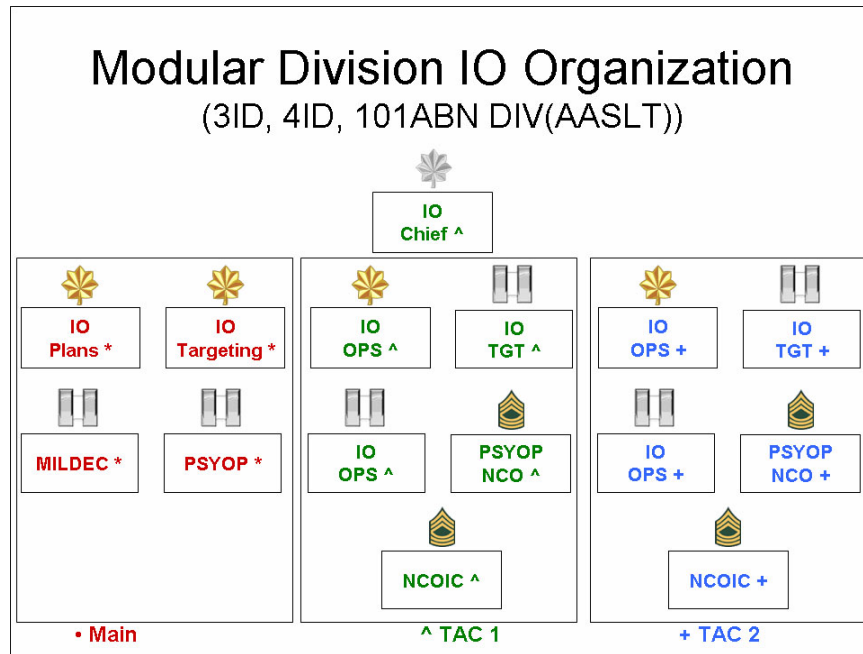

Figure 26: Modular Division IO structure⁷⁶

In Afghanistan, the only IO officers initially supporting OEF were the three IO officers as part of the CFLCC forward staff. In 2002, the XVIII Airborne Corps arrived and began functioning as the CJTF-180. Resourcing requirements for the JTF and CFC-A would come from the JMD. Figures 27 and 28 depict the IO structures of the CJTF-76 and CFC-A in 2005.

⁷⁶ United States Army IO Proponent, January 2006: *Organizational Update Briefing*. PowerPoint Presentation, slide 3.

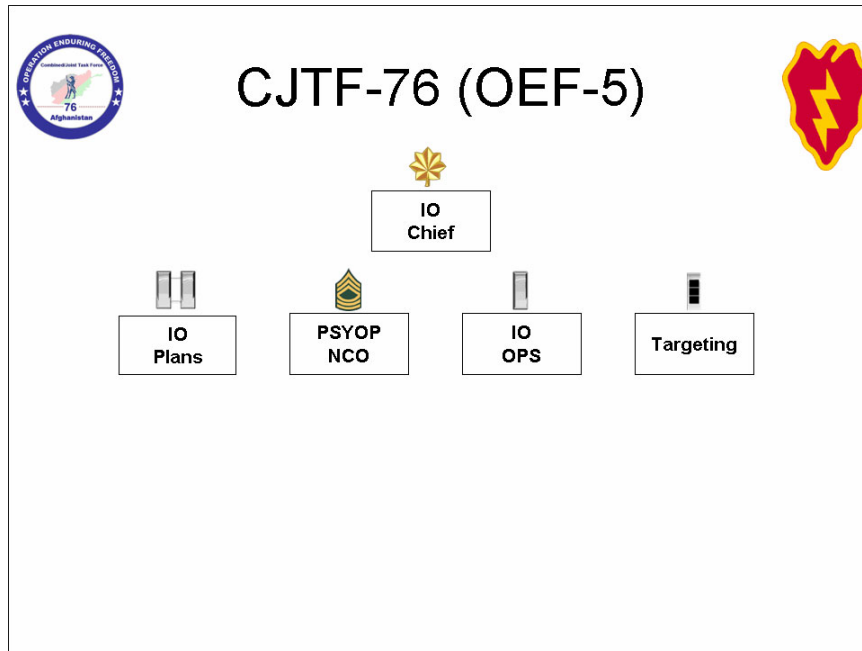

Figure 27: CJTF-76 in OEF-5⁷⁷

This manning did not reflect the JMD stated requirements. The IO Chief by JMD should have been a Marine LTC, but the officer the Marines provided arrived after the Division had deployed to Afghanistan and the Chief of Staff assigned the officer to other duties. The Targeting/EW officer was a US Navy responsibility to fill, but the Navy did not fill the billet, so the IO Chief used the night time Division Targeting Officer to fill the billet.⁷⁸

CJTF-76 working as the tactical command for CFC-A, had to ensure its IO objectives nested with CFC-A. To ensure CFC-A's information objectives stayed synchronized, CFC-A used its effects cell (Figure 28) to synchronize all the messages from IO and PA within the political environment in which CFC-A operated.

⁷⁷ Chip Bircher, Director of Information Operations CJTF-76. *Information Operations in Afghanistan*. PowerPoint Presentation slide 93.

⁷⁸ Chip Bircher, US Army Information Operations Proponent Electronic Warfare Division Chief, interview by author, Fort Leavenworth: 23 January 2006.

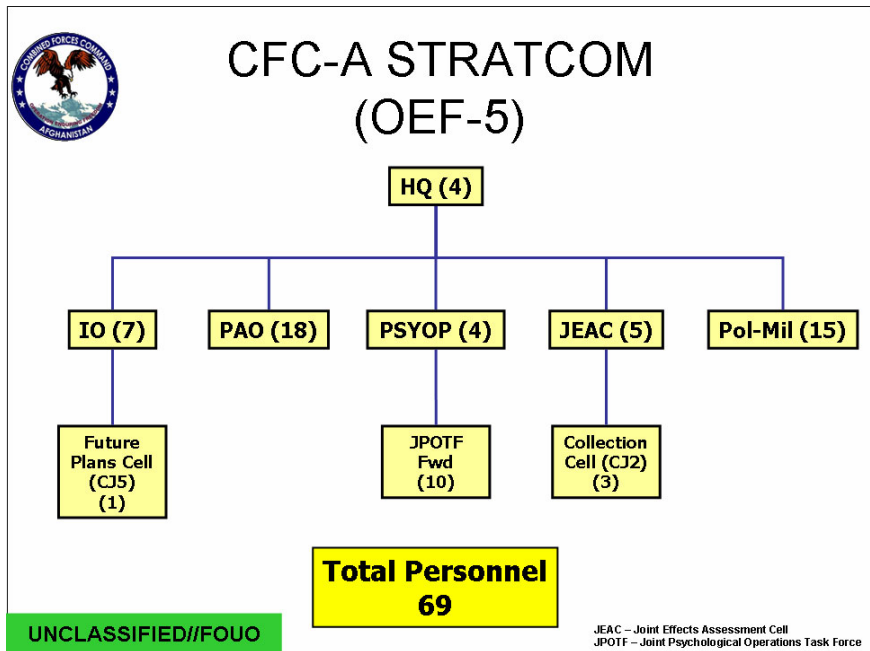

Figure 28: CFC Strategic Communications⁷⁹

This organization proved critical to ensuring CFC-A and its subordinate commands remained synchronized in their attempts to shape the information environment. Part of what makes this organization so successful is that it has intelligence collection and analysis capabilities (JEAC) devoted to assessing the effects on the information environment. The collaboration of intelligence and IO and PA allows the section to develop realistic MOEs and then generate tasking for intelligence collectors to identify the MOEs.

As forces operating in OEF developed force structures that were more effective than what the MTOEs for the Army units allowed, units in OIF were doing the same thing. In March 2003, the IO structure was too small to be effective, by 2004 the IO force structure was more capable and the end of 2004, the IO force structure was even more capable. Commanders made decisions to resource their IO efforts and provide fewer resources to other activities. The next series of charts highlight the evolution of IO staff agencies from April 2003 until the present time.

⁷⁹ Sam Johnson, Chief Joint Interagency Effects Cell. Combined Forces Command Afghanistan. March 2005: *CFC-A Effects Brief*. PowerPoint Presentation, slide 10.

The 4th Infantry Division was the only division to participate in OIF-1 with a dedicated IO Officer and staff. Figure 29 shows the IO structure in the Division Headquarters.

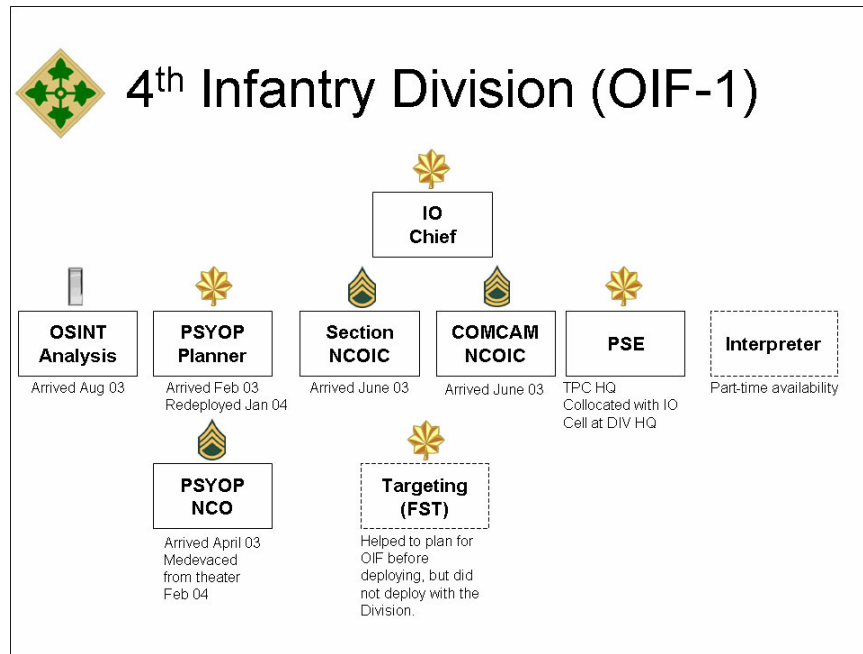

Figure 29: 4ID Headquarters IO Structure

The structure depicted in Figure 29 makes it appear as though the IO support was more robust than it actually was. Only two people (the IO Chief and the PSYOP Planner) deployed initially. All the other resources became part of the IO section after the Division arrived in Iraq. The section had a part-time contract interpreter for about 6 months of the rotation. The rest of the time there was no interpreter support for the section. OSINT became an element of the IO section when this author asked to take responsibility for OSINT from the G2 to ensure OSINT provided the types of products that would be more useful to the section and could provide better oversight of the OSINT cell than the G2 could. The Division's IO Cell provided direct input to Division's effects cell, which was responsible for synchronizing IO, CMO, and to some degree combat operations.

After May, when CFLCC redeployed to the United States, V Corps transitioned (Figure 30) CJTF-7's (Figure 31), the IO section become more robust as the JMD began to take shape and the US military began to fill the required billets.

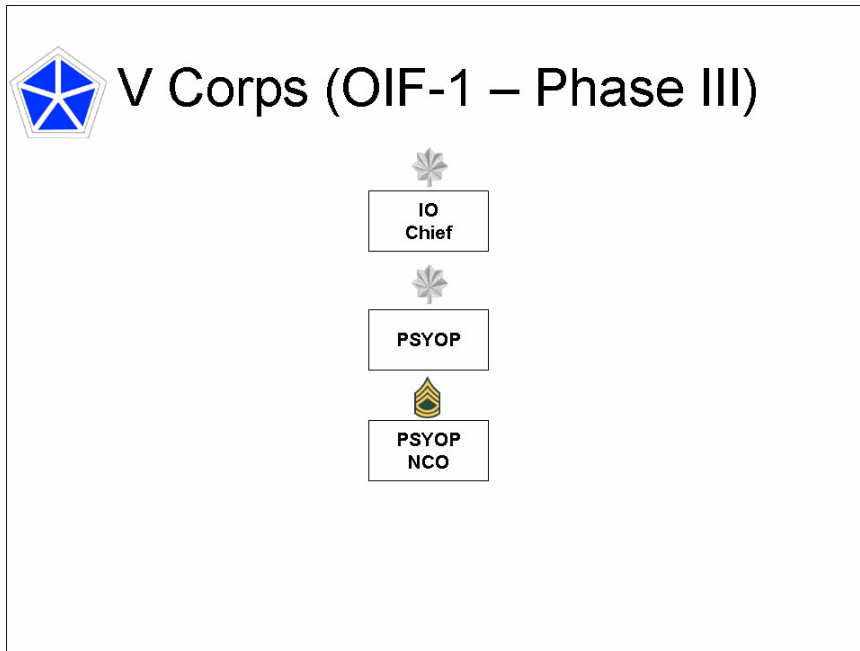

Figure 30: V Corps IO Cell before May 2003

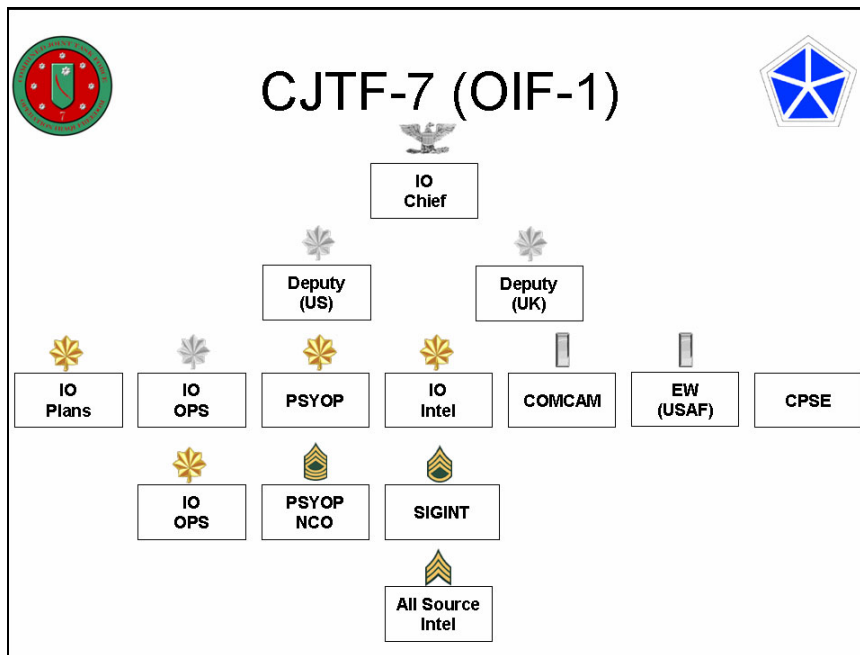

Figure 31: CJTF-7 IO Cell

Even though the CJTF-7 had a more robust IO cell, it continued to be only marginally effective. Two issues prevented the IO cell from becoming more useful. First, the persons manning the IO cell only remained in Iraq for 90 – 180 days. This short turnover prevented the

IO cell from developing a more detailed appreciation of the Iraqi environment. Most members of the CJTF-7 IO cell had little knowledge of the conditions in which the subordinate divisions fought and made very little effort to understand their subordinates' environments. Second, CJTF-7 focused almost entirely on tactical level operations and did not set conditions to allow its subordinate organizations to succeed in their IO efforts. Because CJTF-7 was fixated on the tactical level operations, there were few resources available to shape and analyze the operational level information environment.

CPA's structure was more along the lines of a Strategic Communications (STRATCOM) organization. Figure 32 depicts the structure of the STRATCOM Office:

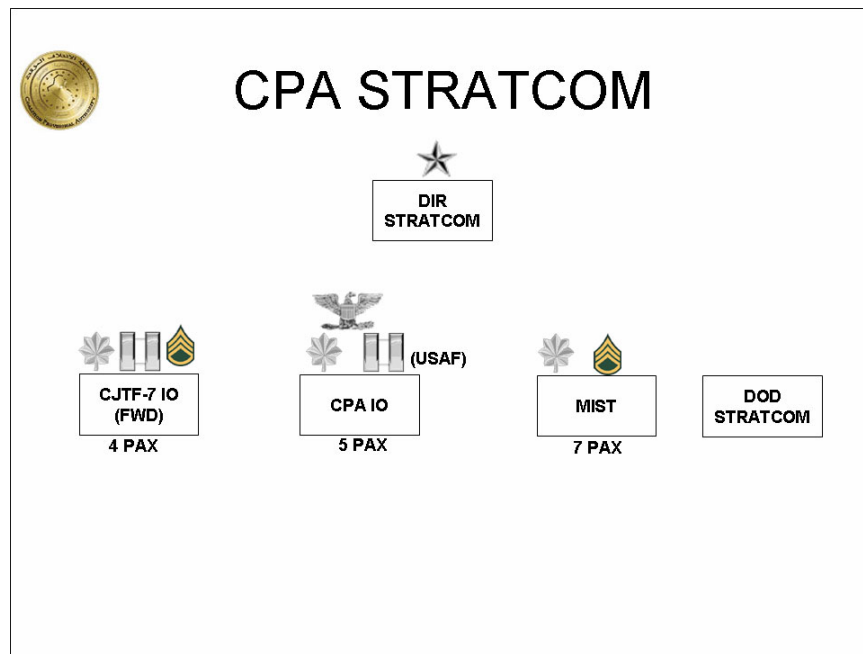

Figure 32: CPA STRATCOM⁸⁰

CPA's STRATCOM Office was no less dysfunctional than CPA itself. It was CPA's STRATCOM that had the responsibility for developing the overarching information campaign to shape the Iraqi Theater of Operations. Working against STRATCOM's ability to shape the strategic information environment was the poor relations between Brigadier General Kimmett, the

⁸⁰ Chuck Kyle, Intelligence Section Chief, Intelligence and Security Branch, Army National Guard Bureau, email interview by author, 15 January 2006.

CPA spokesman and STRATCOM. That relationship was strained at best and hostile at worst. To make matters worse, CPA's daily press briefings focused on tactical combat operations and with few exceptions did little to shape the strategic and operational level information environments. If the IO cell at CJTF-7 was out of touch with the situation within the divisions' areas of operations, CPA's STRATCOM was completely disconnected from the reality outside of Baghdad because with the exception of traveling to and from Camp Victory (CJTF-7 Headquarters) the individuals in STRATCOM rarely traveled outside of the Green Zone and so had almost no sense of the information environment except by the reporting that came from CJTF-7 to CPA or some of the reporting that CPA regional teams generated. Even if CPA's STRATCOM Office had more accurate reporting, it would have done little good since Ambassador Bremer tended to ignore feedback from Iraqi society and proceeded with the agenda he (or those in Washington, D.C) had developed, regardless of how the Iraqis viewed those programs.

With the dissolution of CPA and the activations of MNF-I and MNC-I the IO structures again changed. Lessons learned during OIF-1 were beginning to bear fruit in the way forces in OIF-2 changed how they viewed the information fight. The following charts depict the major IO structures of OIF-2, the 1st Infantry Division, 1st Cavalry Division, MNC-I and MNF-I.

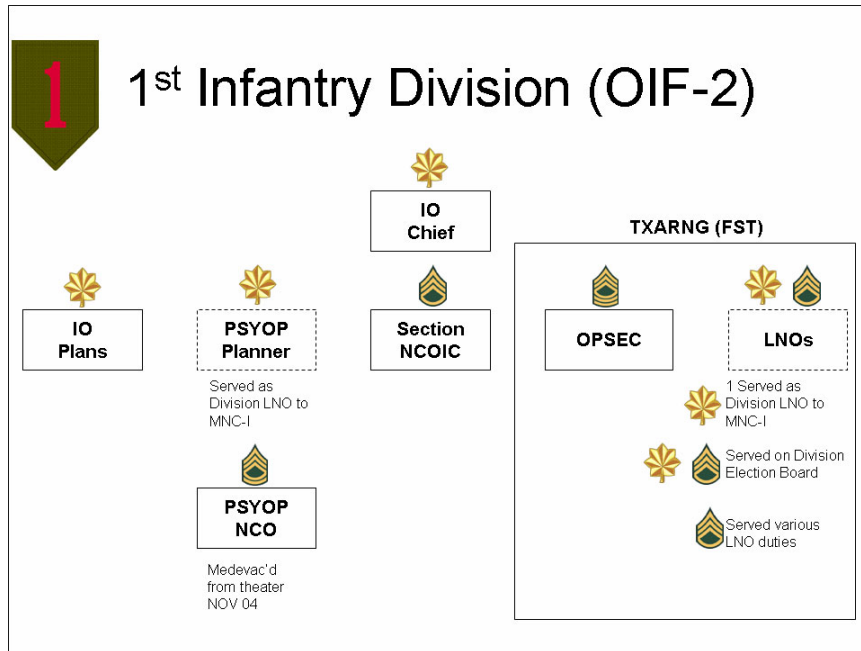

Figure 33: 1ID IO Structure⁸¹

The 1st Infantry Division commander took a more traditional approach in structuring his staff. Much like the 4th Infantry Division, the IO cell was a subcomponent of the Division Effects Cell. The responsibility of the Division IO Coordinator was to ensure the elements of IO were synchronized to support the commander's effects objective. This method proved successful despite the fact that the Division Chief of Staff diverted key personnel to perform tasks that would prevent them from concentrating on their IO support tasks. The 1st Infantry Division was the first division in Iraq to have an FST assigned to it. The FST did not come through the normal request channels, but its presence was a result of direct contact between the 1st Infantry Division and the Texas Army National Guard (TXARNG).

⁸¹ Michael Snyder, 1st Infantry Division IO Coordinator, email interview by the author, 15 January 2006.

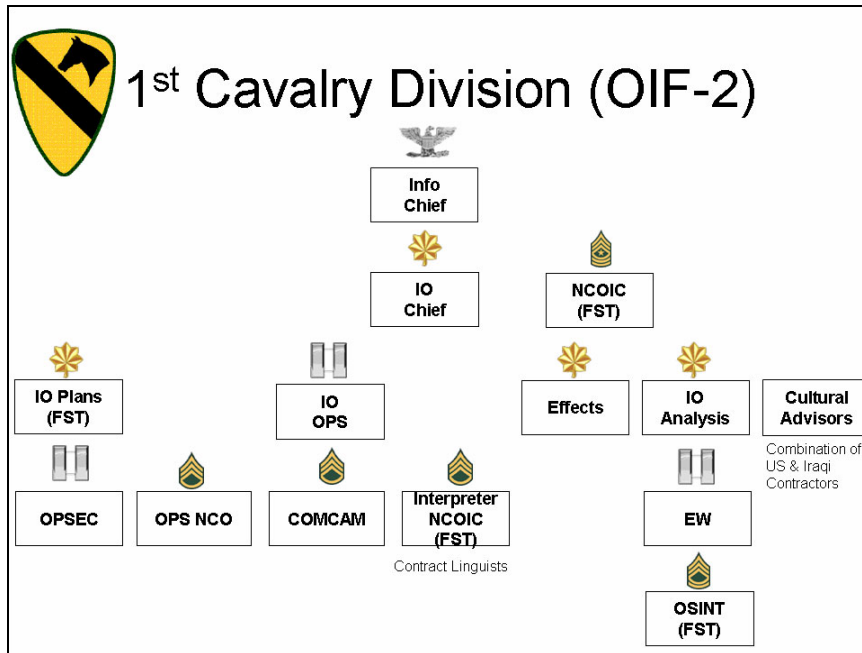

Figure 34: 1CD IO Structure⁸²

Even though the 1st Cavalry Division deployed to Iraq without its fully authorized IO cell, the division took an aggressive approach to IO. The commander created a robust organization that was able to influence the information environment in Baghdad. The total number of personnel working in the exceeded 30 for most of the time the division was deployed. This would be the largest IO cell deployed to Iraq. The commander’s decision to place a Colonel in charge of the information effort helped to ensure that the staff and subordinate commanders placed an appropriate focus on IO themselves.

⁸² Greg Mogavero, Information Operations Branch Assignment Officer, email interview by author, 1 February 2006.

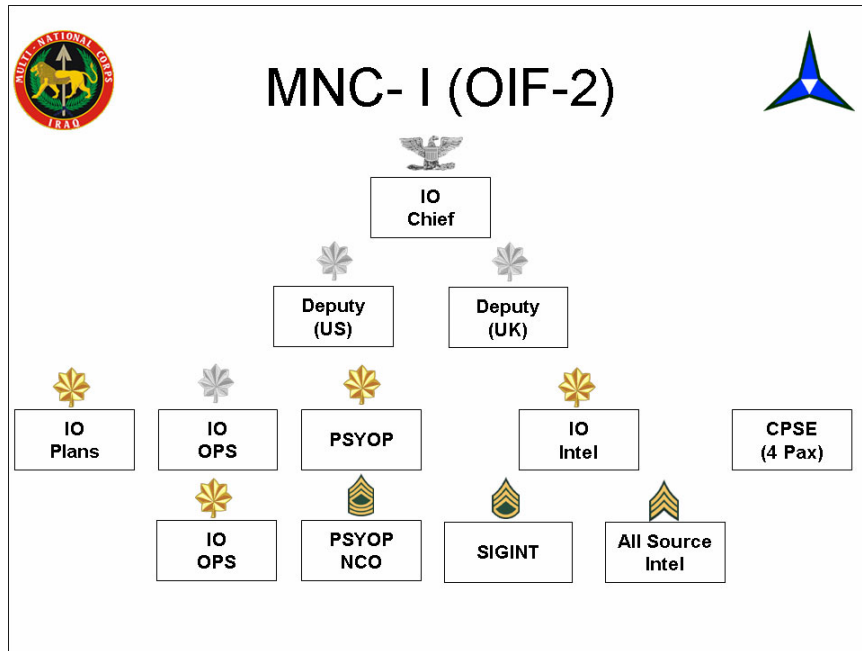

Figure 35: MNC-I IO Structure⁸³

The structure of MNC-I was not all that different from CJTF-7. This is probably a result of the JMD process that developed the manning for CJTF-7. The most significant difference between CJTF-7 and MNC-I was unity of effort between the tactical, operational and strategic operations. With MNF-I focusing on the strategic information environment, MNC-I could focus on the operational and tactical information environments. The relationship between MNC-I and its subordinate commands was less strained than the relationship between CJTF-7 and its subordinates.

⁸³ Mark Garrett, III(US) Corps IO Coordinator, email interview by author, 15 January 2006.

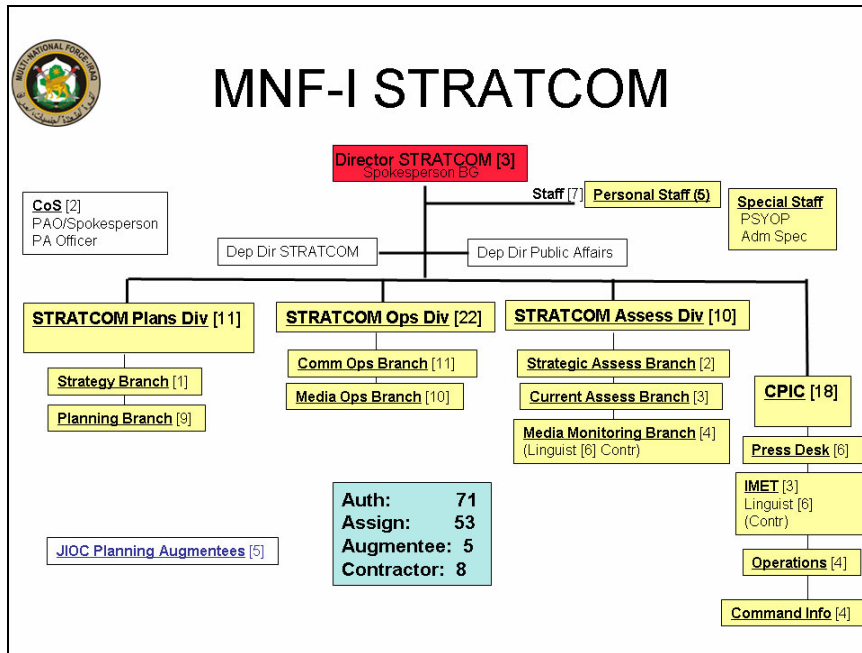

Figure 36: MNF-I STRATCOM⁸⁴

MNF-I developed a very robust STRATCOM structure. Among the improvements over the CPA STRATCOM Office was the inclusion of a dedicated assessment cell. Like other STRATCOM organizations, MNF-I's STRATCOM would provide unity of effort for IO and PA. STRATCOM helped ensure that few strategic information surprises affects MNF-I's subordinate commands. If STRATCOM had a failing, it was in its extreme focus on the desire to tell the good news of the rebuilding effort in Iraq. It was this focus that led to the hiring of the Lincoln Group who planted good news stories in the Iraqi media. The next rotation of OIF would see the introduction of a partially modularized division to the Iraqi Theater.

After its redeployment from Iraq in 2003, the 3rd Infantry Division became the first division to undergo conversion to the modular design. Figure 37 shows the division headquarters' IO staff.

⁸⁴ Scott Nelson, 9 December 2005: *Strategic Communications Overview and Emerging TTP*. PowerPoint Presentation, slide 41.

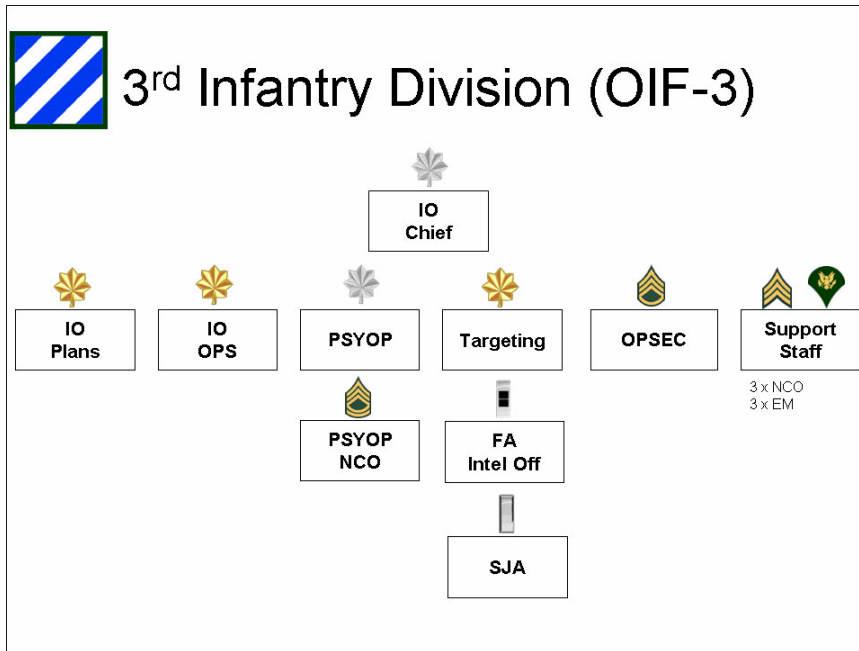

Figure 37: 3ID IO Structure for OIF-3⁸⁵

The 3rd Infantry Division’s IO structure was not a completely modular structure. The Army’s lack of IO officers prevented the division from deploying with all the officers the MTOE authorized. The 3rd Infantry Division’s deployment marked the continuation of a trend that the 1st Cavalry Division began, providing dedicated intelligence support to the IO cell. Although the IO was significantly smaller than the IO cell of the 1st Cavalry Division, which the 3rd Infantry Division replaced, the cell still appeared to be somewhat successful. During its tour, the division was responsible for continuing the training of the Iraqi security forces and helping to create stable conditions in Baghdad for the 2005 constitutional referendum, and national elections.

These changes in IO force structure from 2001 until the current time reflect the Army’s adaptation to an environment in which possessing information superiority became a priority. Early in both conflicts, commanders (some better than others) understood that combat operations alone would not achieve victory, and that changing the attitudes of the peoples of Afghanistan and Iraq would be the key to success in both countries. This was reflected in how they chose to

⁸⁵ Robert Foley, 3rd Infantry Division G-7, email interview by author, 15 January 2006.

resource their information efforts. The development of Offices of Strategic Communication (a non-MTOE organization) demonstrated that commanders realized they had to synchronize their information efforts more through an organizational approach than through an IO Working Group. By creating an organization that collocated PA and IO and having them report together to a higher authority, the commander could ensure that both efforts remained distinct while ensuring their efforts complemented one another.

BIBLIOGRAPHY

- 2004 Afghan Elections Project Website. Available from <http://www.elections-afghanistan.org.af>; Internet.
- Baker, Prestiss O. US Army Information Operations Proponent, Specified Proponent Chief. Interview by the author, 16 November 2005. Fort Leavenworth.
- Bircher, Chip. Nelson, Scott. "Strategic Communications and the Afghan Presidential Election." 2005.
- Bircher, Chip. Director of Information Operations CJTF-76. *Information Operations in Afghanistan*. PowerPoint Presentation.
- _____. US Army Information Operations Proponent Electronic Warfare Division Chief. Interview by author, 23 January 2006. Fort Leavenworth.
- Bremer, L. Paul. *My Year in Iraq: The Struggle to Build a Future of Hope*. New York: Simon and Shuster. 2005.
- Cable News Network (CCN) Website. <http://cnn.com>
- Center for Army Lessons Learned. *CTF Warrior Initial Impressions Report - Operation Enduring Freedom 04-10*. Fort Leavenworth: May 2004.
- _____. *Information Operations CAAT Initial Impressions Report 05-03*. Fort Leavenworth: May 2005.
- _____. *Initial Impressions Report: Stability Operations – Support Operations Operation Iraqi Freedom*. Fort Leavenworth: December 2003
- _____. *OEF/OIF CAAT Initial Impressions Report: Stability Operations – Support Operations*. Fort Leavenworth: December 2003.
- _____. *Operation Iraqi Freedom (OIF) CAAT II Initial Impressions Report 04-13*. Fort Leavenworth: May 2004.
- _____. *Targeting for Victory: Winning the Civil Military Operations. Tactics, Techniques and Procedures 03-23* Fort Leavenworth: September 2003.
- Chiarelli, Peter W. Patrick R. Michaelis. "Winning the Peace, the Requirement for Full-Spectrum Operations." *Military Review* (July-August 2005): 4-17.
- Report of the Defense Science Board Task for On: The Creation and Dissemination of All Forms of Information in Support of Psychological Operations (PSYOP) in Time of Military Conflict*. Office of the Under Secretary of Defense for Acquisition, Technology and Logistics. Washington, DC: 2000.
- Darley, William M. "Why Public Affairs Is Not Information Operations." *Army*. January 2005. <http://www.ausa.org/webpub/DeptArmyMagazine.nsf/byid/CCRN-6CCSFT>
- Diamond, Larry. *Squandered Victory, The American Occupation and the Bungled Effort to Bring Democracy to Iraq*. New York: Times Books. 2005.
- Field Manual 2-0, *Intelligence*. Headquarters Department of the Army. Washington, D.C.: 2004.
- Field Manual 3-0, *Operations*. Headquarters Department of the Army. Washington, D.C.: 2001.
- Field Manual 3-05.30, *Psychological Operations*. Headquarters Department of the Army. Washington, D.C.: 2005.

Field Manual 3-07, *Stability Operations*. Headquarters Department of the Army. Washington, D.C.: 2003.

Field Manual-Interim 3-07.22, *Counterinsurgency Operations*. Headquarters Department of the Army. Washington, D.C.: 2004.

Field Manual 3-13, *Information Operations*. Headquarters Department of the Army. Washington, D.C.: 2003.

Field Manual 3-55.12, *Multiservice Tactics, Techniques and Procedures for Joint Combat Camera Operation*. Headquarters Department of the Army. Washington, D.C.: 2003..

Field Manual 3-61.1, *Public Affairs Tactics, Techniques and Procedures*. Headquarters Department of the Army. Washington, D.C.: 2003.

Field Manual 5-0, *Army Planning and Orders Production*. Headquarters Department of the Army. Washington, D.C.: 2005.

Field Manual 6-20-10, *Tactics Techniques and Procedures for the Targeting Process*. Headquarters Department of the Army. Washington, D.C.: 1996.

Field Manual 46-1, *Public Affairs Operations*. Headquarters Department of the Army. Washington, D.C.: 1997.

Federation of American Scientists Website. Available from <http://fas.org>; Internet.

Foley, Robert.. 3rd Infantry Division G-7. Email interview by author. 15 January 2006.

Fontenot, Gregory, E.J. Degan, David Tohn. *On Point: The United States Army in Operation Iraqi Freedom*. Annapolis: Naval Press Institute. 2005.

Ford, Christopher M. "Speak No Evil: Targeting a Population's Neutrality to Defeat an Insurgency." *Parameters* (Summer 2005): 51-66.

Franks, Tommy. *American Soldier*. New York: Harper-Collins. 2004

Galula, David. *Counterinsurgency Warfare Theory and Practice*. New York: Frederick A. Praeger. 1968 Reprint New York: Frederick A. Praeger. 2005

Garrett, Mark. III(US) Corps IO Coordinator. Email interview by author. 15 January 2006

Global Security Website. <http://www.globalsecurity.org>

Iraqi Media Net Website. <http://iraqimedianet.net/>

Johnson, Sam. Chief Joint Interagency Effects Cell. Combined Forces Command Afghanistan. March 2005: *CFC-A Effects Brief*. PowerPoint Presentation.

Krumm, Kenneth. *FA-30 Man the Force: Senior Leader Update*. United States Army Information Operations Information Operations Proponent. 4 January 2006. PowerPoint Presentation.

Joint Publication 2-0. *Intelligence Support to Joint Operations*. Department of Defense: Washington, DC. 2000.

Joint Publication 3-53. *Doctrine for Joint Psychological Operations*. Department of Defense: Washington, DC: 2003.

Kyle, Chuck, Intelligence Section Chief, Intelligence and Security Branch, Army National Guard Bureau. Email interview by author 15 January 2006.

LA Times Website. <http://www.latimes.com>; Internet.

Mogavero, Greg. Information Operations Branch Assignment Officer. Email interview by author. 15 January 2006.

McFate, Montgomery. "The Military Utility of Understanding Adversary Culture." *Joint Forces Quarterly*. July 2005. 42 -

Lieutenant General McKiernan, David. September 2003: *Operation Iraqi Freedom CFLCC Observations. Briefing to Senior Intelligence Leaders*. PowerPoint Presentation

General Richard C. Myer, Memorandum titled, "*Policy on Public Affairs Relationship to Information Operations*." 24 September 2004.

Nelson, Scott, US Army Information Operations Proponent Division of IO Leader Development and Education. Interview by author, 23 January 2006. Fort Leavenworth.

Nelson, Scott. 9 December 2005: *Strategic Communications Overview and Emerging TTP*. PowerPoint Presentation.

Payne, Kenneth. "The Media as an Instrument of War." *Parameters*. Spring 2005. 81-93.

Public Relations Society of America website. <http://www.prsa.org>; Internet.

Snyder, Michael. 1st Infantry Division IO Coordinator. Email interview by the author. 15 January 2006.

Special Warfare Center and School. *Psychological Operations Handbook: Equipment Types, Specifications, and Capabilities*. Fort Bragg: 2005.

Strykula, John. *Intelligence Support to Information Operations*. Rand Corporation 2005.

Turabian, Kate L. *A Manual for Writers of Term Papers, Theses, and Dissertations*. 6th ed. Chicago: University of Chicago Press. 1996.

United States Army Training Support Center Website. Available from <http://www.adtdl.army.mil>; Internet.

United States Army Force Management Support Agency Website. Available from <https://webtaads.belvoir.army.mil>; Internet.

United States Army IO Proponent. January 2006: *Organizational Update Briefing*. PowerPoint Presentation.

US President George W. Bush. "Address to the Nation." (7 October 2001) Available from <http://www.whitehouse.gov/news/releases/2001/10/20011007-8.html>; Internet.

US President George W. Bush. "Address to the Nation." (19 March 2003) Available from <http://www.whitehouse.gov/news/releases/2003/03/20030319-17.html>; Internet.

Wolesi Jirga and Provincial Council Elections 2005 Website. Available from <http://www.jemb.org/index.html>; Internet

Woodward, Bob. *Bush at War*. New York: Simon and Schuster. 2002

Woodward Bob. *Plan of Attack*. New York: Simon and Schuster. 2004